



Main catalogue

System pro *M* compact®

Surge and lightning protection solutions

System pro M compact®

Surge and lightning protection solutions

Panorama	2	1
General information	4	2
Surge and lightning protection solutions	21	3
Selection table	76	4
Applications - Technical definitions - Norms and standards	80	5
Index	86	6

Panorama

1



LOVOS surge protection of distribution transformer

- Avoid insulation damages
- Prolonged life time of a transformer
- Reduce system disturbance
- Cost savings in maintenance or equipment replacements.

Most of distribution transformers are protected on the primary side with surge arresters. Representing substantial capital investment and being a key component for reliable and continuous electricity supply, the transformer should always be protected against surge damage or deterioration on the secondary side with low voltage surge arresters.



OVR Type 1 and Type 1+2 main entrance lightning protection

- Surge and lightning protection (LPZ 0 to LPZ 1 and 2)
- Protection of the installation against direct lightning
- Impulse discharge current (Iimp) from 7 to 100 kA.

Exposed building to lightning surges shall be protected with Type 1 or Type 1+2 surge protective devices (SPDs). With a high impulse current discharge capacity (Iimp), they are located at the service entrance of the installation to avoid the destruction of the main switch board. Building protected against lightning with an external lightning protection (simple rod, meshed cage or ESE) must have at least a Type 1 SPD in the main distribution board.



OVR Type 2 and OVR Plus surge protective devices

- Surge protection (LPZ 1 to 2...)
- Sub-distribution board installation
- Prolonged life time of sensitive equipment
- Autoprotected surge protective devices with the OVR Plus range.

Most of the equipment sustain repetitive transient surges. Generated by indirect lightning strikes or by industrial environment, these transient overvoltages deteriorate and drastically reduce the life time of sensitive equipment like computers. Located in the sub-distribution boards of the installation, as close as possible to the equipment to protect, they offer a reliable and safe surge protection.

NEW OVR PV T1

Specific solar surge and lightning protection

With a dedicated technology, the specific thermal disconnection for DC solar installation of the OVR PV range ensure a safe surge protection. Easy to install with double connections terminals and pluggable cartridges for an easy replacement, the OVR PV T1 comply with specific PV SPDs standard UTE C 61-740-51.





OVR PV and OVR WT specific surge protection solutions

- Dedicated SPDs for solar and wind application
- Surge and lightning protection from LPZ 0 to LPZ 2
- Cost saving in avoiding down time of installations.

Due to their high exposure to lightning and their specific electrical configuration, solar and wind turbine installations require a dedicated surge and lightning protection which take into consideration their specificities, high DC voltages for solar and high repetitive peak voltages for wind turbines. The use of standard surge protection on such installation may lead to down time or even destruction of the installation.



OVR TC dataline protection

- Complete range from 6 to 200 V DC
- RJ 11 and RJ 45 bases.

Data centers to prevent data losses or water treatment installation to protect the flowmeters require protection against transient overvoltages.



OPR external air terminal lightning protection

- Early streamer emission air terminal
- Complete autonomy
- High efficiency (radius of protection R_p)
- Comply with NF C17-102 September 2011.

Lightning is one of the most spectacular meteorological phenomena. Generated by the interaction of clouds elements (water and ice), it can kill, injure and damage. Building and equipment installed in exposed areas should be protected by an external air terminal.

NEW OVR WT range

The wind surge and lightning protection

Due to their height, wind turbines have especially high exposure to lightning, they need high capacity and reliable lightning and surge protection. The OVR WT takes into consideration the specificity of wind installations with a high peak repetitive voltage withstand (U_{rp} up to 3 kV) ensure a safe protection to Wind applications. It can be DIN mounted with the OVR WT 3L 690 P TS or fixed close to the equipments to protect with the OVR WT 3L 690 enclosed solution.



Surge and lightning protection solutions

Causes of transient overvoltages

2 Transient surges represent the main cause of electrical devices failure and loss of productivity. They are the result of lightning strikes, switching operations on the electrical network or parasitic interferences.

Nowadays, in all the sectors (residential, commercial and industrial), in the data center industry, they rely on their computer systems.

A downtime in one of these computer systems, due to transient surges, can have catastrophic consequences. Loss of operation, loss of service, loss of data and of productivity involve, in most of the cases, huge consequences which are, by far, higher than the costs of the equipments for protection against overvoltages.

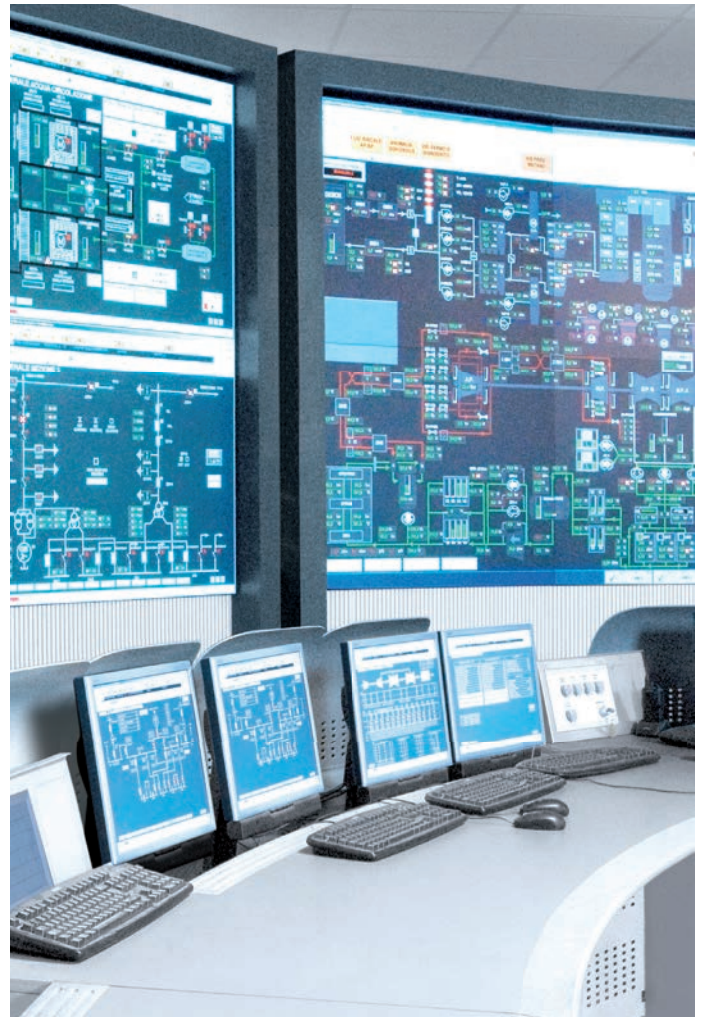

The use in electronic systems of more and more sensitive electronic equipments, with interconnection and complexity of the nets increase the probability of damages caused by the transient overvoltages.

Surge and lightning protection solutions

Causes of transient overvoltages

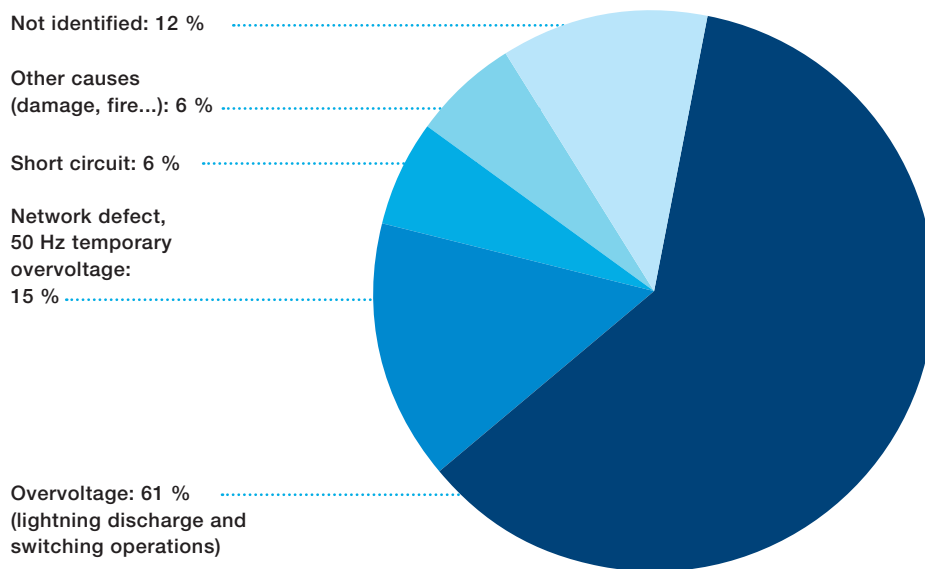

Damages to electronic equipment. Analysis conducted in France for residential segment by AVIVA, one of the largest insurance company (www.aviva.com)

At the same time, the following trends shall be underlined:

- Increasing use of electronic systems such as computers, telecommunication equipment. Overvoltage consequences are of huge importance in a global economy based and relying on power networks and information systems.
- Electronic equipment more and more sensitive. With miniaturization process of circuits and components in electronic, modern equipment is now more incline to be damaged from transient overvoltages.
- Interconnection and complexity of system networks. In big cities, the effects induced by lightning current are very high due to the fact that they can be propagated by the service lines over many kilometers. Furthermore, the use of lots of industrial equipment generates disturbances, transient overvoltages, on the lines that damage expensive equipment.

Therefore, the protection against lightning current and transient overvoltages is now a fundamental aspect of our electrical system configuration.



Transient overvoltage effect

Surge and lightning protection solutions

ABB expertise

With its experience gained over the last few decades, ABB is using its technological expertise for lightning and overvoltage protection.

2

The ABB laboratory with several generators can simulate the impact of a direct lightning strike (10/350 μ s impulse wave) or an indirect lightning strike (8/20 μ s impulse wave) to be able to test the surge protective devices.

Through its wide product range, ABB is able to offer a complete solution to protect power and low current networks.

Seminars are organized to the needs of all professionals: design offices, consultants, distributors, electricians, sales staff. These training sessions combine practical and theoretical aspects and cover a varied range of topics such as direct impact protection and overvoltage protection.

The ABB laboratory is able to handle tests on AC surge protective devices (SPDs) according to IEC 61643-11 and on PV SPDs according to technical guide UTE C 61-740-51 (prEN 50539-11).

High power generator	Standardized electrical waves 8/20 μ s and 10/350 μ s. Maximum shock current 100 kA for the two waves, superimposed on the electrical network. Stored energy 800 kJ.
200 kV generator	1.2/50 impulse wave Maximum voltage 200 kV Stored energy 10 kJ.
Combination wave generator	Standardized 8/20 - 1.2/50 impulse wave 30 kV maximum 30 kA maximum Stored energy 5 kJ.
Electrical tests	440 V, 5000 A short circuit testing.
Mechanical tests	On-load operating test of sockets and strips.



ABB laboratory at Bagnères-de-Bigorre, France

Surge and lightning protection solutions

Causes of transient overvoltages

Transient overvoltages due to direct lightning effects

When a lightning strikes directly a building equipped with a lightning protection system (LPS), the lightning current is dissipated to the ground through the down conductors. However, the transient overvoltage can be propagated into the building through the earthing of the electrical installation. This type of

direct effect can cause fire, damage the internal installation and the equipment or even worse can injury living beings.

The same with a lightning strike on external line connected to the building, which can, through the cables, create fire and destruction of the internal electrical installation.

2

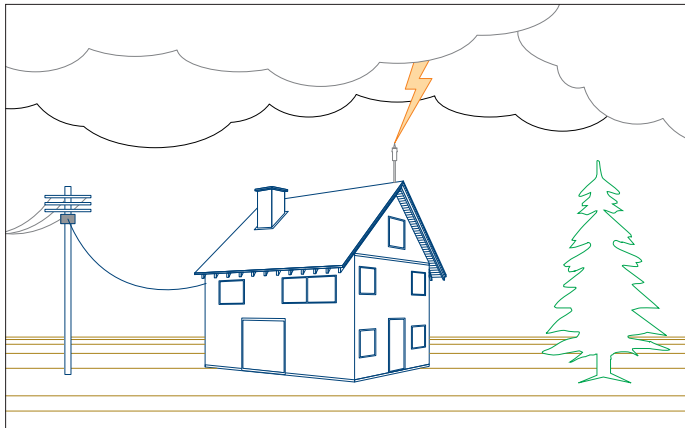

Lightning strike on an external air terminal or on the building

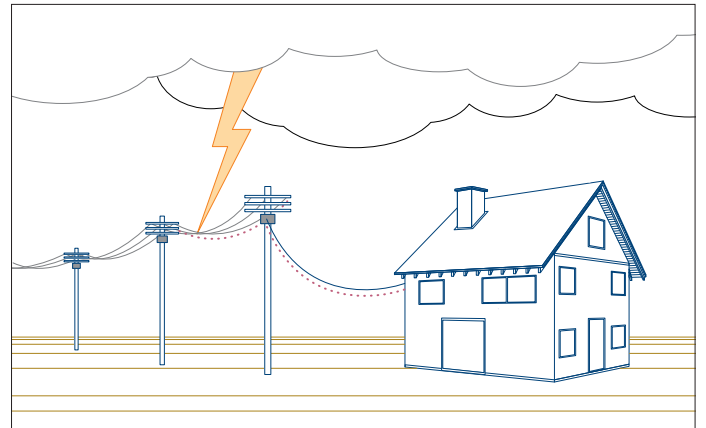

Lightning strike on an overhead line connected to the building

Transient overvoltages due to indirect lightning effects

Transient overvoltages can also be the effect of an indirect lightning strike close to the building or close to external lines connected to the building. In that case, the electromagnetic

field created by the lightning current will generate resistive and inductive couplings. As a consequence, these can cause serious malfunction or damages to the internal installation or equipment.

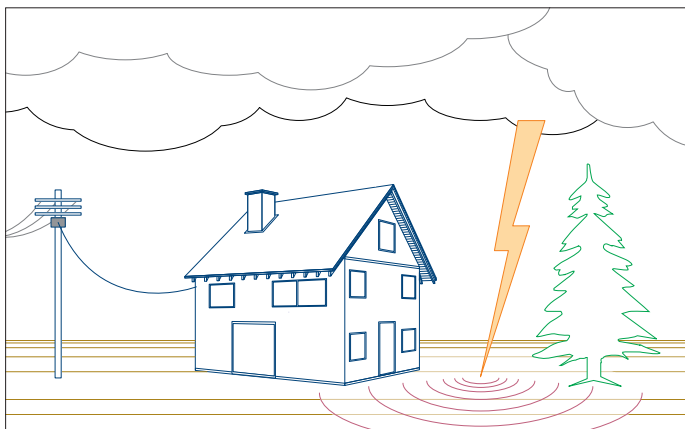

Lightning strike near a building

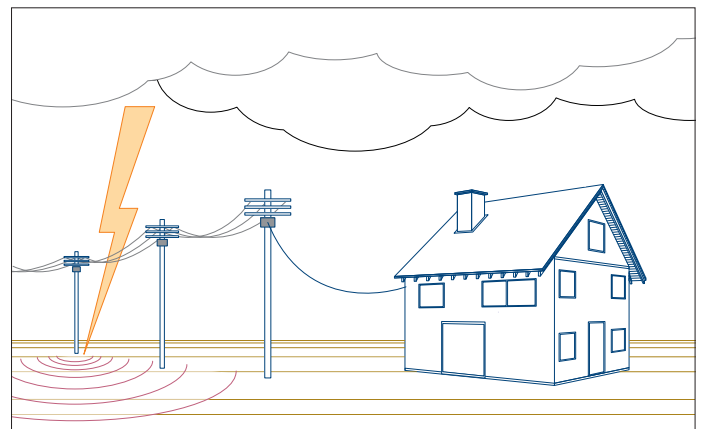

Lightning strike near an overhead line

Transient overvoltages due to switching operations

Switching overvoltages are less powerful and destructive than transient surges caused by lightning. However, they occur much more frequently, causing premature ageing of the equipment.

These overvoltages can in fact result in severe damage to electronic circuit and need to be effectively countered to avoid expensive downtime and maintenance costs.

Surge and lightning protection solutions

Selection of surge protective devices

2

The IEC standard introduced the concept of lightning protection zones (LPZ) to help in selecting the correct surge protection. This concept ensures the gradual reduction by stages of the energies and overvoltage caused by lightning or switching operations. This logic of coordination in the protection is what we call the “stepping protection”.

External Zones:

- LPZ 0A Unprotected zone outside the building subject to direct lightning strikes and therefore may have to handle the full lightning current and lightning electromagnetic field.
- LPZ 0B Zone protected against direct lightning strikes by external air terminal and where the threat is the full lightning electromagnetic field.

Internal Zones:

Zones inside the building which are protected against direct lightning flashes.

- LPZ 1 Zone subject to partial lightning or surge currents. Type I SPDs shall be installed at the boundary between LPZ 0A and LPZ 1 to reduce the entrance of lightning currents through power lines.
- LPZ 2...n Zone where the surge current is limited by current sharing and where the surge energy is reduced by additional surge protection like SPDs. Type 2 SPDs are installed at the boundaries of each zone, i.e. LPZ 1 and LPZ 2, LPZ 2 and LPZ 3, etc.

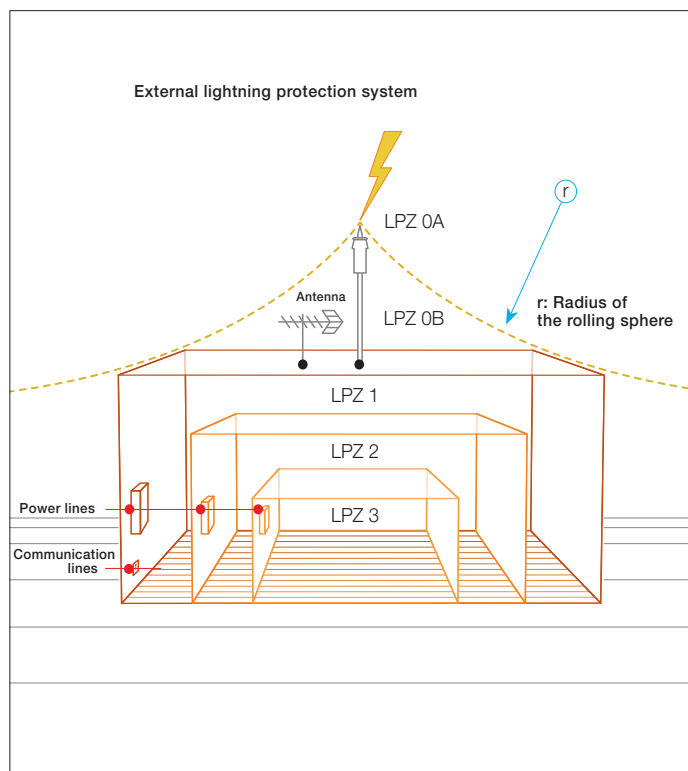

Lightning protection zones description (IEC 62305-4):

It consists in dividing a building in several volumes: the protection zone. The objective is to ensure that the LPZ gives enough protection to the equipment inside this zone. To do so, SPDs are installed at the protection zone boundaries. Each time an SPD is installed, a new protection zone is created.

Current impulse:

The 10/350 and 8/20 impulse waves are used in the Class I and Class II SPDs tests. The first number gives the rising time of the current impulse to reach 90% of the peak level and the second number gives the time to half value in micro-seconds (μs).

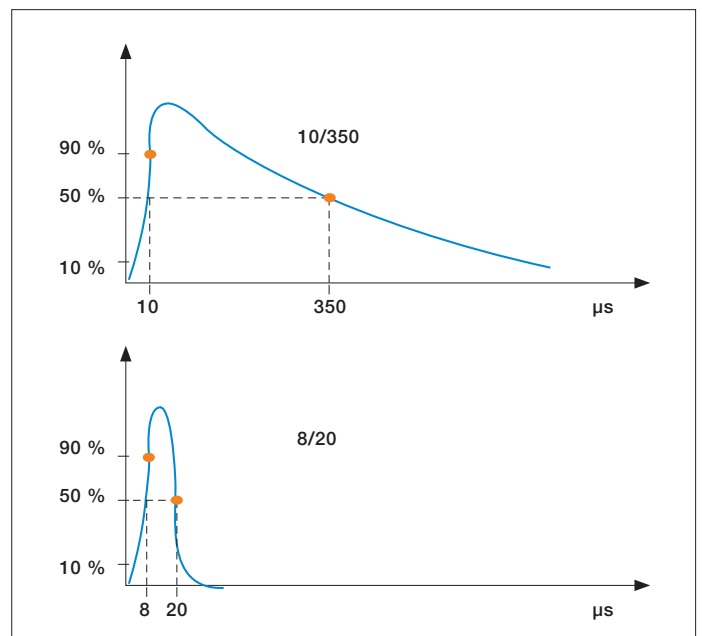

Surge and lightning protection solutions

Selection of surge protective devices

Protection level and impulse withstand voltage

The protection level (U_p) of the SPD shall be selected according to the level of overvoltage given to the equipment to be protected against transient surge.

Each equipment is rated with an impulse withstand voltage (U_w) depending on its category. An equipment is protected if its U_w is greater than the expected transient overvoltage between the live conductors and earth (common mode). If not, an SPD must be installed.

The SPD is protecting the equipment if its protection level (U_p), which is calculated under the nominal current (I_n), is equal or lower to the impulse withstand voltage of the equipment:

$$U_{p/f} \leq U_w$$

The IEC 60364-4-44 defines the required impulse withstand voltage as described in the table below:

Categories*	U_n		Examples
	230 /400 V	400 /690 V	
I	1500 V	2500 V	Equipment containing particularly sensitive electronic circuits: – computer workstations, computers, TV, HiFi, Video, Alarms, etc.; – household appliances with electronic programmers, etc.
II	2500 V	4000 V	Domestic electrical equipment with mechanical programmers, portable tools, etc.
III	4000 V	6000 V	Equipment subject to special requirements. Distribution panels, switches, breakers, etc.
IV	6000 V	8000 V	Equipment for use at the origin of the installation. Electricity meters, circuit-breakers, etc.

* IEC 60664-1

Selection of surge protective device

The selection of the surge capacity of SPDs depends on the surge and lightning risk, determined by the risk analysis according to IEC 62305-2. If there is a direct lightning risk on the structure, a Type 1 SPD will have to be installed at the service entrance and Type 2 and Type 3 SPDs in the sub-distribution boards, as close as possible to the equipment to protect.

If there is not a direct lightning risk on the structure (no external protection, no aerial lines connected) a Type 2 SPD can be installed at the service entrance and in the sub-distribution boards.

A Type 1 SPD will be selected by its maximum impulse current (I_{imp}) characteristics, and a Type 2 SPD by its nominal current (I_n) and maximum discharge current (I_{max}) characteristics.

Basic example for a Type 1 SPD calculation (IEC62305-4):

- Lightning Protection Level calculated: LPL I
- Maximum peak current: $I=200$ kA
- Assumption: perfect current sharing
- Number of connected service supply (earthing, water pipe): $m=2$
- Network configuration: 3 Phases + Neutral ($n=4$)

$$\begin{aligned} \text{Total current } (I_{imp})/\text{phase} &= I \times 0.5 / (m \times n) \\ &= 200 \times 0.5 / (2 \times 4) \\ &= 12.5 \text{ kA} \end{aligned}$$

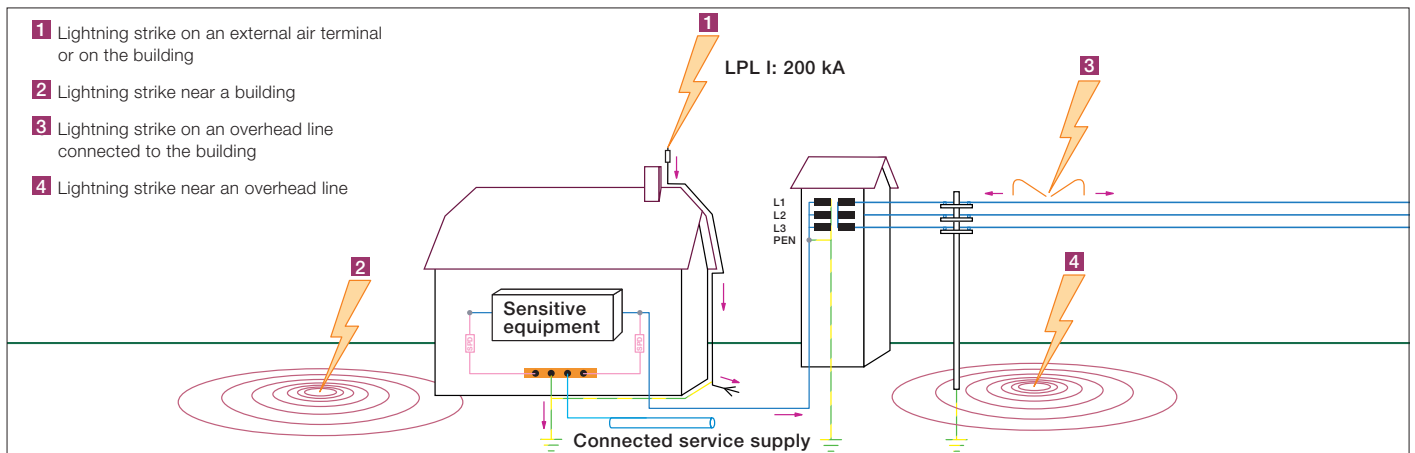

Surge and lightning solutions

Selection of surge protective devices

2

End of life indicator of the surge protective device

This option enables indication of the surge protective device state via a mechanical indicator which changes from green to red as the surge protective device comes to end-of-life. When this occurs, the surge protective device must be changed as protection is no longer guaranteed.

Safety Reserve (s) system

In case of current surge exceeding the maximum capacity of the device, the surge protective device will switch to the Safety reserve position and the remote indicator (TS) will switch to defect. Consequently, the user is warned in advance and has more time to replace the cartridge, because in Safety reserve position the protection is still ensured due to the 2-stage disconnecting system.

Pluggable

The pluggable feature of ABB surge protective devices facilitates maintenance. Should one or more worn cartridges need to be replaced, the electrical circuit does not have to be isolated nor do the wires have to be removed.

Auxiliary contact (TS)

This function, achieved by wiring a 3-point 1 A volt-free contact, enables the operational state of the surge protective device to be checked remotely (maintenance premises).

Technical features of the integrated auxiliary contact

- Contacts information: Normally-opened (NO) / Normally-closed (NC)
- Min. load: 12 V DC - 10 mA
- Max. load: 250 V AC - 1 A
- Connection cross-section: 1.5 mm².

End-of-life indicator

Normal End-of-life

Safety Reserve system

Normal In Reserve End-of-life

NOTE:
A faulty surge protective device does not interrupt continuity of service (if wired such that priority is given to continuity of service), it simply disconnects itself. But, the equipment is no longer protected.

NOTE:
Pluggable surge protective device cartridges have a foolproof system (Neutral cartridges different to Phase cartridges) preventing incorrect operations when replacing a cartridge.

TS

min : 12 V_{DC}, 10 mA
max : 250 V_{AC}, 1 A

Wiring schematic

Surge protective device fitted with the auxiliary contact option

pro M compact® range

Max. discharge current I_{max} 8/20

15 kA
40 kA
70 kA
120 kA

Impulse current I_{imp} 10/350

15 kA
25 kA

s: with safety reserve **P**: pluggable device

OVR T2 N1 40 275 s P TS

Designation:
T1: Type 1 SPD
T1+2: Type 1+2 SPD
HL: Type 1+2 SPD with MOVs
T2: Type 2 SPD
PLUS: Autoprotected SPD
PV: Photovoltaic SPD
TC: Dataline SPD
WT: Wind turbine SPD

Phases:
1N: 1 phase (left) - neutral (right)
3N: 3 phases (left) - neutral (right)
N1: neutral (left) - 1 phase (right)
N3: neutral (left) - 3 phases (right)
3L: 3 poles
4L: 4 poles
without: 1 pole

Max. operating voltage U_c :
440 V
320 V
275 V
150 V
75 V

Auxiliary contact

Surge and lightning protection solutions

Surge protective device disconnectors

Choice of backup protection

Surge protective device must have disconnectors which are internal and external. Internal is the so called thermal disconnection which helps to disconnect the SPD at the end of life (varistors technology). External is the backup protection which can be an MCB or a fuse dedicated to the SPD protection in case of short circuit due to very high surge transient current for example.

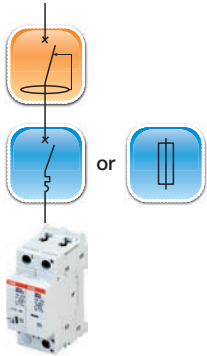

Designation	Function
Protection against indirect contact	Residual current devices (RCDs) assure a protection to people and installation. When installed with SPDs they must be of selective type "S" to avoid nuisance tripping. In ABB portfolio you can choose the F200 S type range for a safer installation.
Protection against fault currents	Miniature circuit breakers (MCBs) or fuses protect the installation against overload and short circuit. They can be associated with SPDs for the backup protection in agreement with coordination installation rules. You can either choose MCBs from the S200 or S800 series or fuses from the E90 range.
Thermal protection	The thermal disconnection is an internal disconnection which is there to bring a safer protection to the equipment. ABB is always developing new patents and has developed a thermal disconnection mechanism specifically dedicated to PV installation with the OVR PV range for a better and safer protection.

Type of Surge Protective Devices	System earthing	Circuit breaker maximum ratings * curve B or C				Fuses maximum ratings* (gL - gG)
		Prospective short circuit current at SPD location (I _p)				
		I _p ≤ 6 kA	I _p ≤ 10 kA	I _p ≤ 25 kA	I _p ≤ 50 kA	
Type 1						
OVR T1 I _{imp} 25 kA / I _{fi} ≤ 50 kA U _c 255 and 440 V	TNC TNS/TT 1Ph+N TNS/TT 3Ph+N	-	-	-	S803S - 125 S802S - 125 S804S - 125	E 933/125 - 125 A E 931N/125 - 125 A E 933N/125 - 125 A
Type 1+2						
OVR T1+2 I _{imp} 25 kA / I _{fi} ≤ 15 kA U _c 255 V	TNC TNS/TT 1Ph+N TNS/TT 3Ph+N	-	-	-	S803S - 125 S802S - 125 S804S - 125	E 933/125 - 125 A E 931N/125 - 125 A E 933N/125 - 125 A
OVR T1+2 I _{imp} 15 kA / I _{fi} ≤ 7 kA U _c 255 V	TNC TNS/TT 1Ph+N TNS/TT 3Ph+N	-	-	-	S803S - 125 S802S - 125 S804S - 125	E 933/125 - 125 A E 931N/125 - 125 A E 933N/125 - 125 A
OVR T1+2 I _{imp} 7 kA U _c 275 V	TNC TNS/TT 1Ph+N TNS/TT 3Ph+N	S203 - 50	S203 M - 50	S203 P - 50	S803S - 50 S802S - 50 S804S - 50	E 933/50 - 50 A E 931N/50 - 50 A E 933N/50 - 50 A
OVR HL I _{imp} 15 kA U _c 440 V	TNC TNS/TT 1Ph+N TNS/TT 3Ph+N	S203 - 50	S203 M - 50	S203 P - 50	S803S - 50 S802S - 50 S804S - 50	E 933/50 - 50 A E 931N/50 - 50 A E 933N/50 - 50 A
Type 2						
OVR T2 pluggable I _{max} 15 kA U _c 75 V	TNC TNS/TT 1Ph+N TNS/TT 3Ph+N	S203 - 16 S201 - 16 NA S203 - 16 NA	S203 M - 16 S201 M - 16 NA S203 M - 16 NA	-	-	E 93/32 - 16 A E 91N/32 - 16 A E 93N/32 - 16 A
OVR T2 pluggable I _{max} 15, 40 and 70 kA U _c 275 and 440 V	TNC TNS/TT 1Ph+N TNS/TT 3Ph+N	S203 - 50 S201 - 50 NA S203 - 50 NA	S203 M - 50 S201 M - 50 NA S203 M - 50 NA	S203 P - 50 S201 P - 50 NA S203 P - 50 NA	S803S - 50 S802S - 50 S804S - 50	E 933/50 - 50 A E 931N/50 - 50 A E 933N/50 - 50 A
OVR T2 non-pluggable I _{max} 20 and 40 kA U _c 150 V, 275 and 440 V	TNC TNS/TT 1Ph+N TNS/TT 3Ph+N	S203 - 63 S201 - 63 NA S203 - 63 NA	S203 M - 63 S201 M - 63 NA S203 M - 63 NA	S203 P - 63 S201 P - 63 NA S203 P - 63 NA	S803S - 63 S802S - 63 S804S - 63	E 933/125 - 125 A E 931N/125 - 125 A E 933N/125 - 125 A
Type 3						
OVR T3 I _{max} 10 kA U _c 275 V	TNC TNS/TT 1Ph+N TNS/TT 3Ph+N	S203 - 10 S201 - 10 NA S203 - 10 NA	S203 M - 10 S201 M - 10 NA S203 M - 10 NA	-	-	E 93/32 - 25 A E 91N/32 - 25 A E 93N/32 - 25 A

* Maximum ratings, must be in accordance with the installation to follow coordination rules with main or upstream short circuit protection(s).

Service entrance SPDs	PE connection cable size
Type 1	16 mm ²
Type 2	4 mm ²

Surge and lightning protection solutions

Mode of surge protection

2

Protection in common and/or differential mode

Common mode

Overvoltages in common mode concern all neutral point connections. They occur between the live conductors and earth (e.g. phase/earth or neutral/earth). The neutral conductor is a live cable, as well as the phase conductors.

This overvoltage mode destroys not only earthed equipment (Class I), but also non-earthed equipment (Class II) with insufficient electrical insulation (a few kilovolts) located close to an earthed mass.

Class II equipment that is not situated close to an earthed mass is theoretically protected from this type of attack.

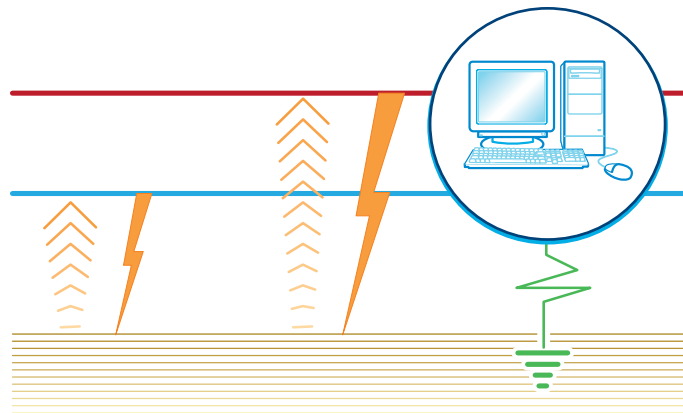

Overvoltages in common mode

Differential mode

Overvoltages in differential mode circulate between the live phase/phase or phase/neutral conductors. They can cause considerable damage to any equipment connected to the electrical network, particularly "sensitive" equipment.

These overvoltages concern TT earthing systems. They also affect TN-S systems if there is a significant difference in length between the neutral cable and the protective cable (PE).

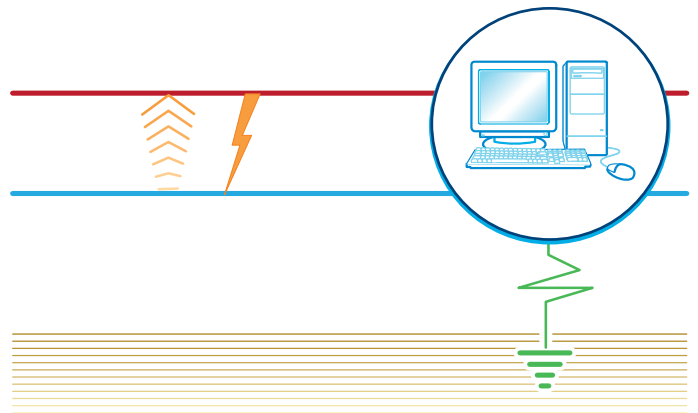

Overvoltages in differential mode

Different types of OVR configuration

Either Common mode or differential mode of protection are required depending on the system configuration (IT, TNC, TNS, TT). For that purpose, you can find different OVR configuration (single pole, 3L, 4L, 1N, 3N).

Common mode configurations (TNC networks)

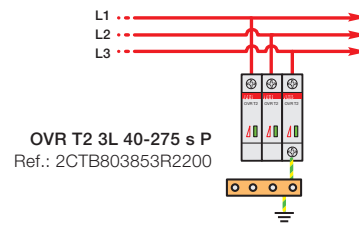
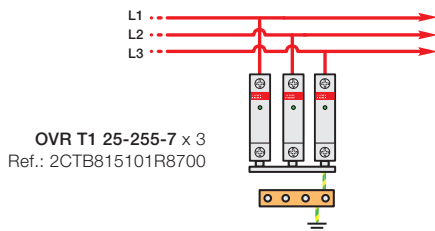

Common and differential mode configurations (TNS, TT networks)

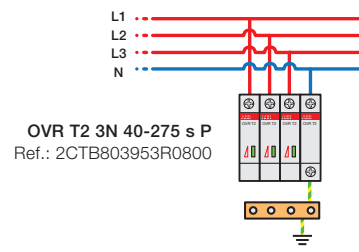
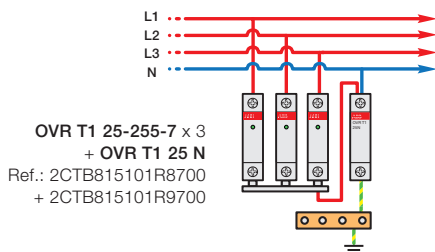

Surge and lightning protection solutions

Coordination and wiring principals

The SPD installed at the line entrance of an installation may not ensure an effective protection to the whole system. As a matter of fact, the selection of the voltage protection level (U_p) of SPDs depends on many parameters: Type of equipment to be protected, the length of the connections to the SPDs, the length in between the SPDs and the equipment to be protected.

Coordination required if :

The protection level (U_p) of the SPDs is not low enough to protect the equipment.
If the distance in between the SPDs and the equipment is >10 m.

NOTE:

The first SPD is diverting most of the surge current to the ground, and the second SPD will ensure a good protection level to the equipment.

It is what we call the stepping protection.

Coordination between Type 1 and Type 2 surge protective device

Type 1
25 kA (10/350)
 $I_{fi} = 50$ kA

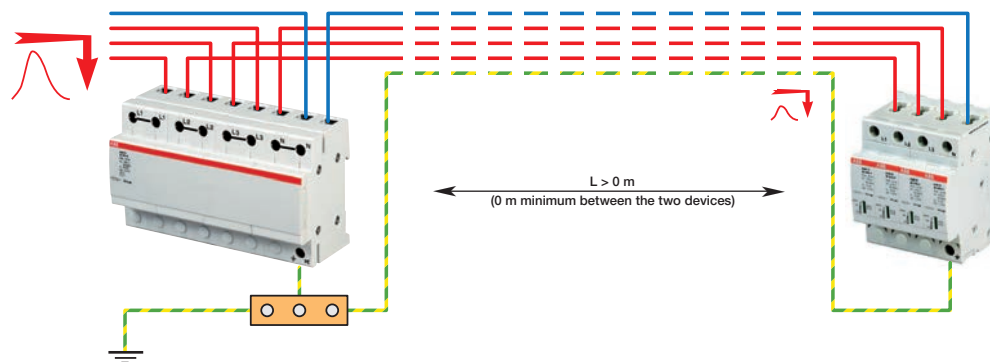

Type 2
40 kA (8/20)

Type 1
25 kA (10/350)
 $I_{fi} = 7$ kA

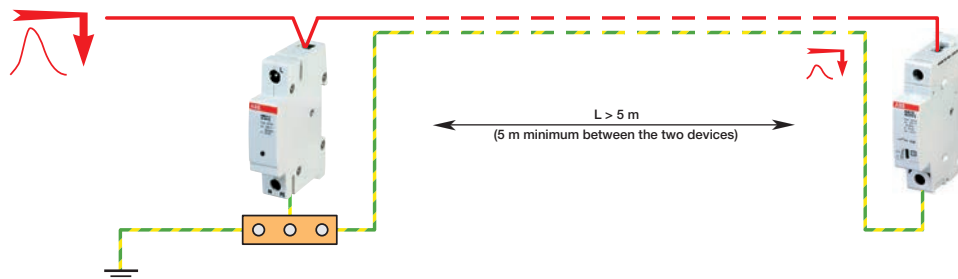

Type 2
40 kA (8/20)

Coordination between Type 2 surge protective devices

Type 2
70 kA (8/20)

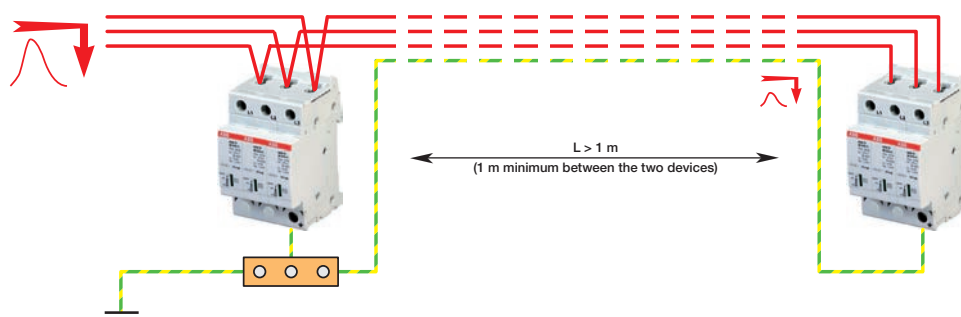

Type 2
40 kA (8/20)

Protection against transient overvoltages

General wiring diagrams

Wiring diagrams according to IEC 60364-1

2

TNC system
230/400 V

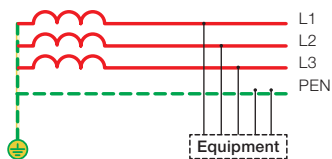

TNC-S system
230/400 V

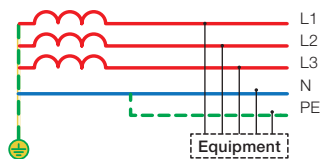

TNS system
230/400 V

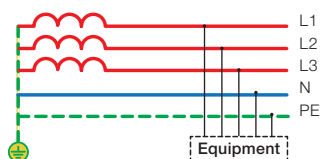

TT system
230/400 V

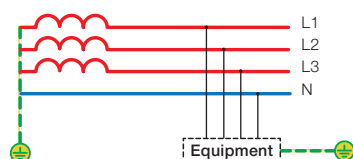

IT system
230/400/600 V

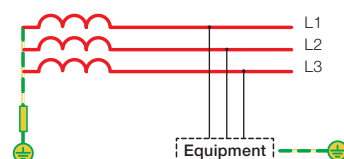

Other wiring diagrams

Single phase
120/240/277 V

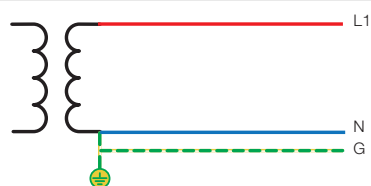

Split phase
240/120 V, 480/240 V



Delta
240/480/600 V

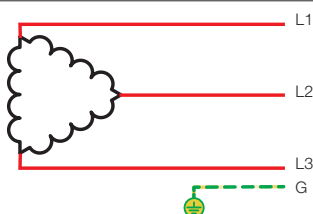

Grounded Wye
208 Y/120 V, 480 Y/277 V, 600 Y/347 V

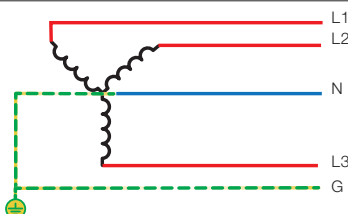

High-Leg Delta
240/1200 V HLD

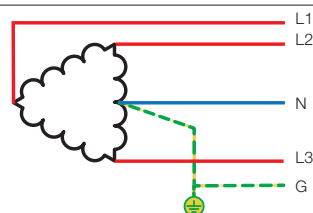

Surge and lightning protection solutions

Selection tool: TNC network 230/400 V

Industry, commercial building

Configuration 1

$15 \text{ kA} \leq I_p \leq 50 \text{ kA}$

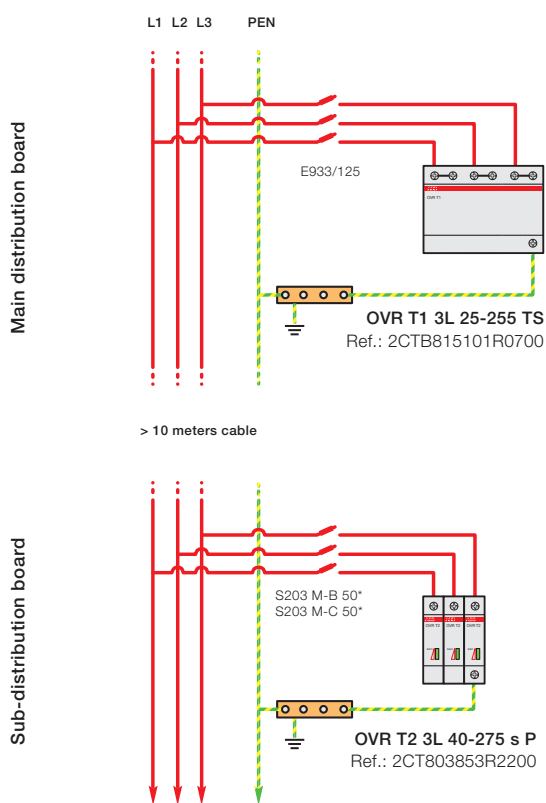

Configuration 2

$I_p \leq 15 \text{ kA}$

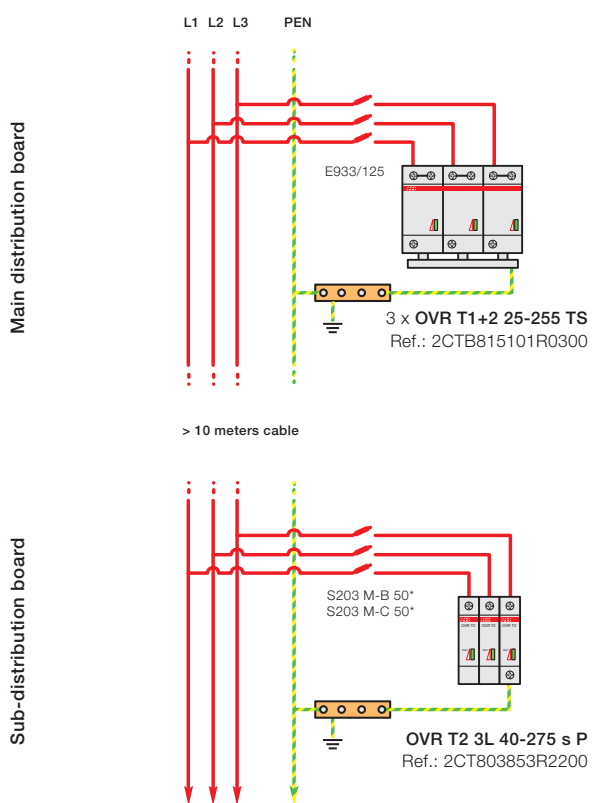

I_p : prospective short circuit current of the power supply

* Must be according to the coordination rules with main or upstream short circuit protection(s).

Surge and lightning protection solutions

Selection tool: TNC-S network 230/400 V

Industry, commercial building

2

Configuration 1
 $15 \text{ kA} \leq I_p \leq 50 \text{ kA}$

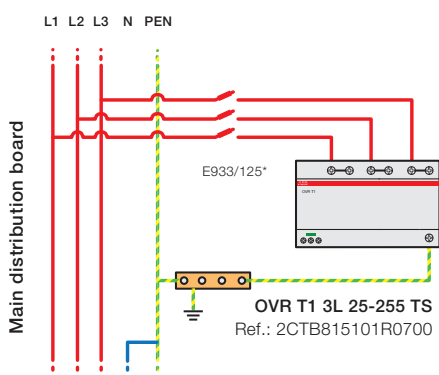

> 10 meters cable

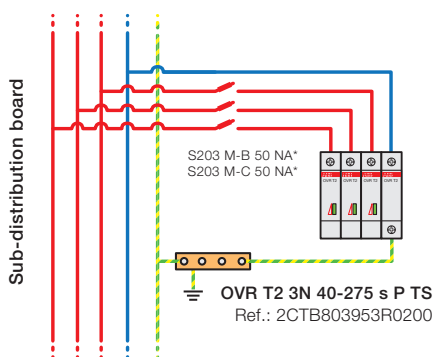

> 10 meters cable

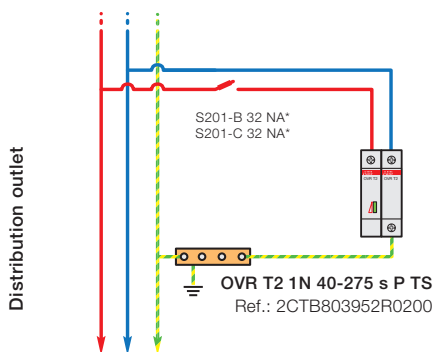

Configuration 2
 $7 \text{ kA} \leq I_p \leq 15 \text{ kA}$

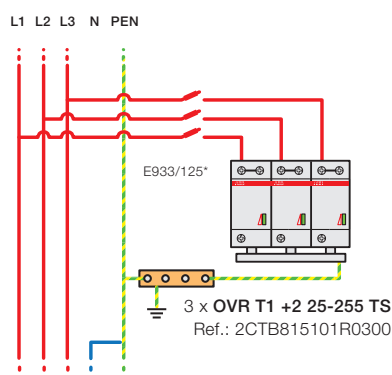

> 10 meters cable

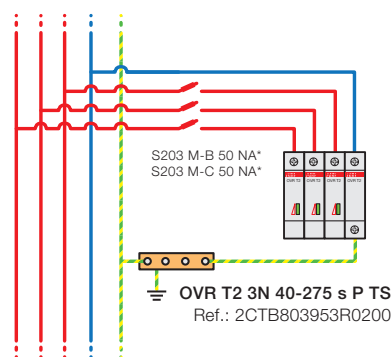

> 10 meters cable

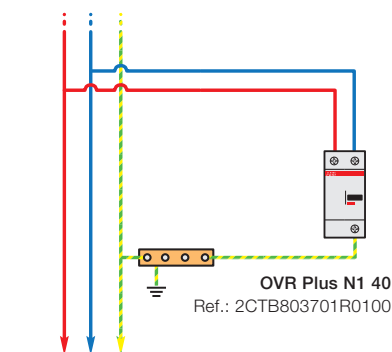

Configuration 3
 $I_p \leq 7 \text{ kA}$

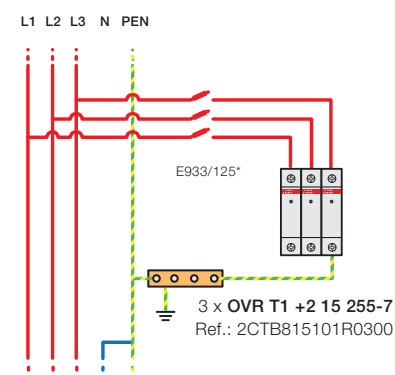

> 10 meters cable

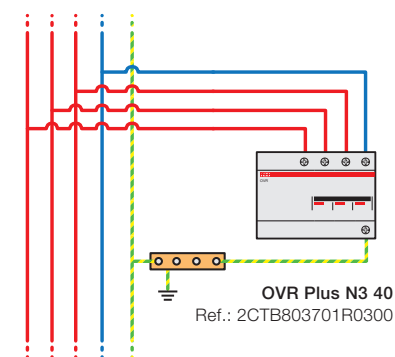

> 10 meters cable

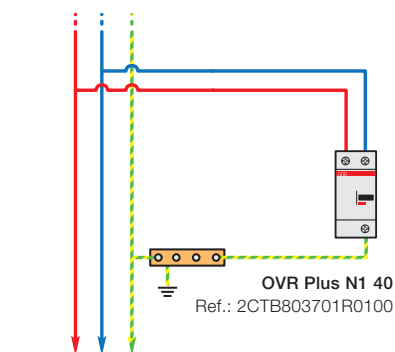

I_p : prospective short circuit current of the power supply
 * Must be according to the coordination rules with main or upstream short circuit protection(s).

Surge and lightning protection solutions

Selection tool: TT network 230/400 V

Industry, commercial building

Configuration 1
 $15 \text{ kA} \leq I_p \leq 50 \text{ kA}$

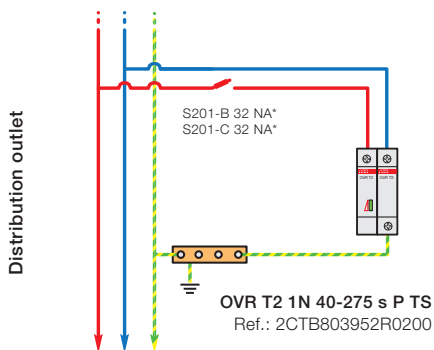
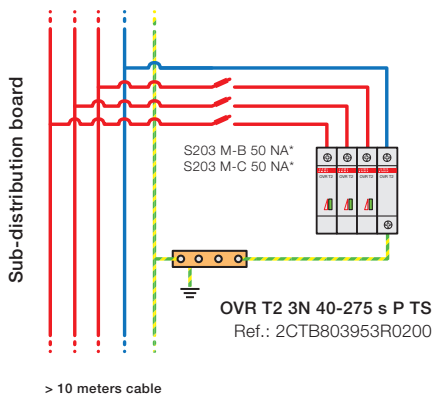
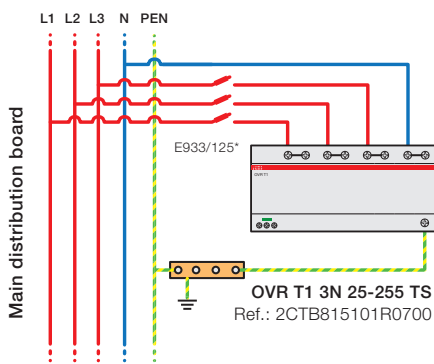

Configuration 2
 $7 \text{ kA} \leq I_p \leq 15 \text{ kA}$

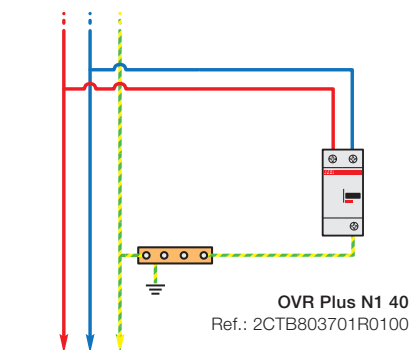
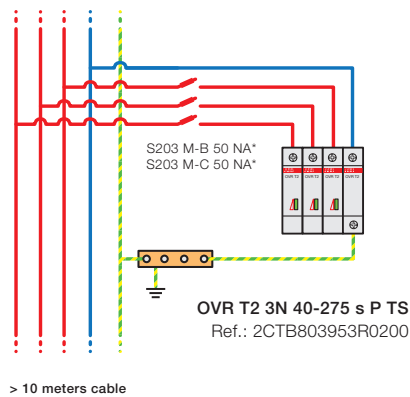
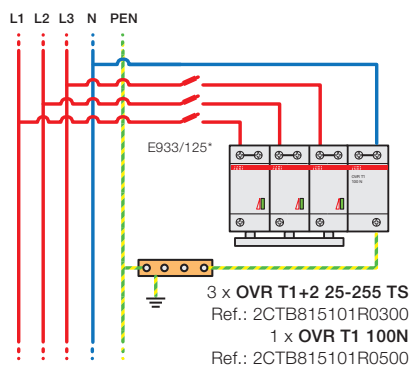

Configuration 3
 $I_p \leq 7 \text{ kA}$

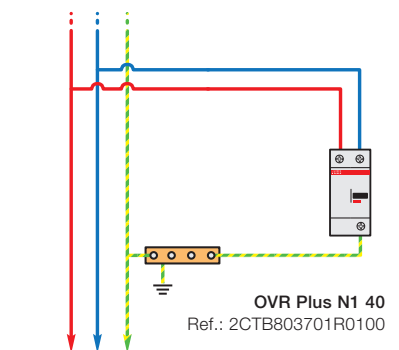
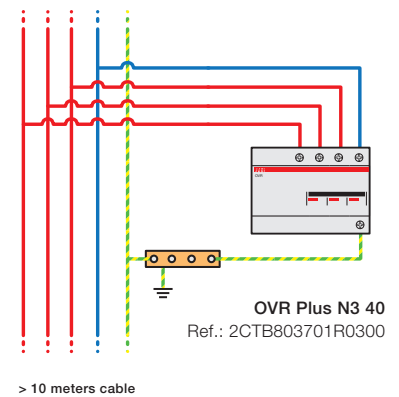
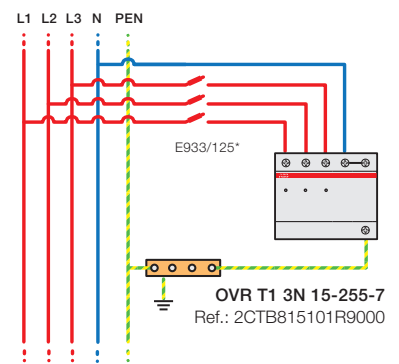

I_p : prospective short circuit current of the power supply
 * Must be according to the coordination rules with main or upstream short circuit protection(s).

Surge and lightning protection solutions

Selection tool: IT network 230 V without neutral

Commercial, residential

The IT system has all live parts at the source isolated from earth or one part connected to earth with a high impedance.

2

Configuration 1 $I_p \leq 50 \text{ kA}$

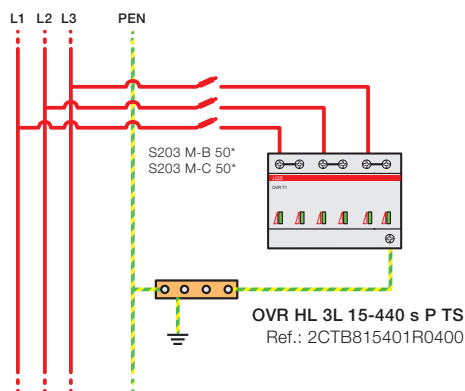

> 10 meters cable

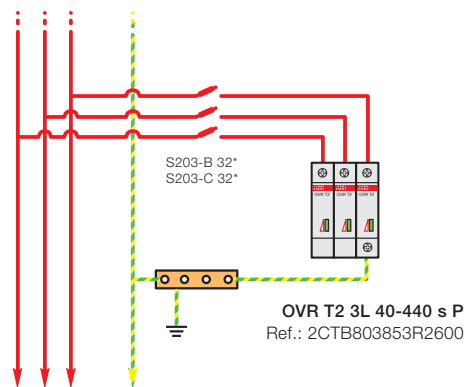

Configuration 2 $I_p \leq 15 \text{ kA}$

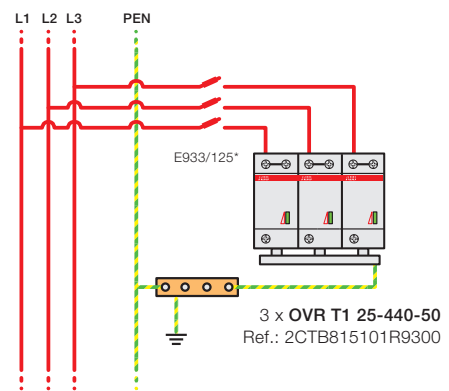

> 10 meters cable

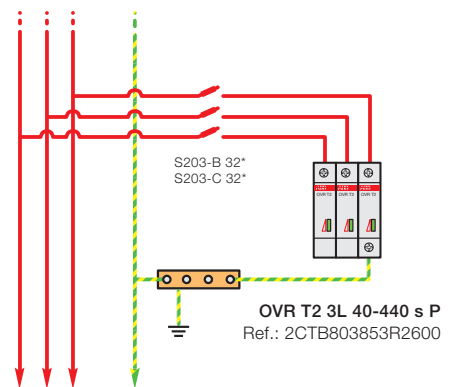

I_p : prospective short circuit current of the power supply

* Must be according to the coordination rules with main or upstream short circuit protection(s).

Surge and lightning protection solutions

Selection tool: TNC, TNS/TT networks 230/400 V

Residential

With external conductive parts (external lightning protection air terminal, antenna...) or powered by aerial lines

YES



NO



2

Neighbour with external lightning protection system (or generally with earthed extraneous conductive parts), or proximity of high points

YES

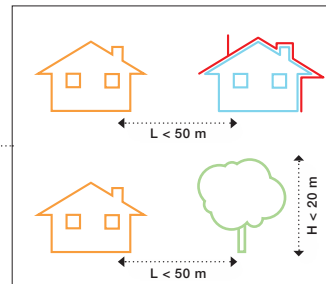

NO

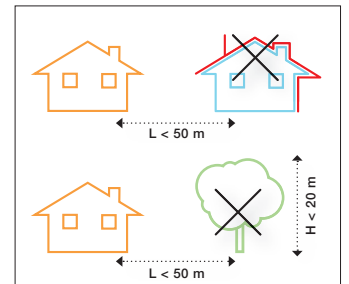

Configuration 1

With risk of direct lightning current (external protection, aerial lines...)

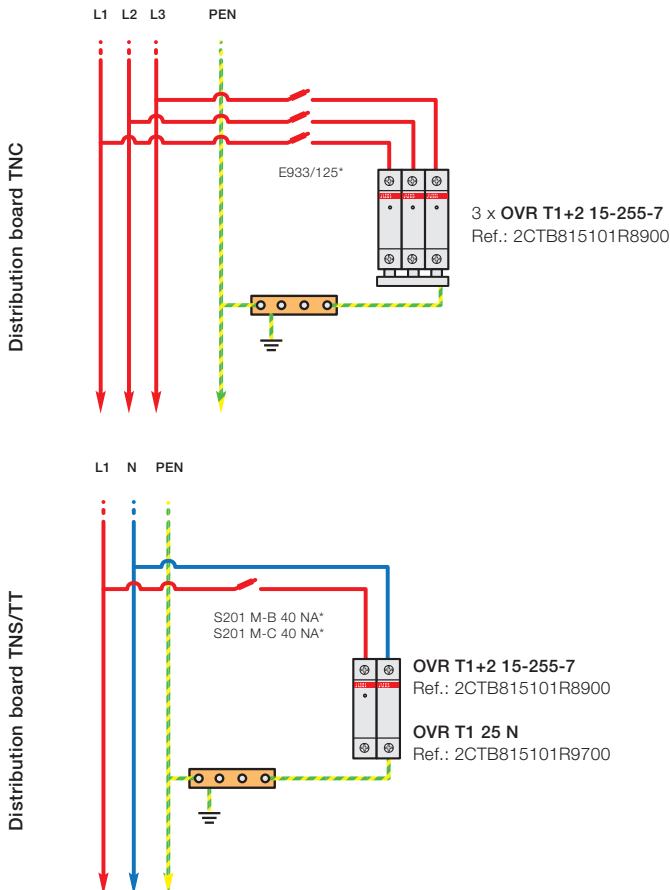

* Should be according to the coordination rules with installed main breakers

Configuration 2

With risk of indirect lightning current, transient surges

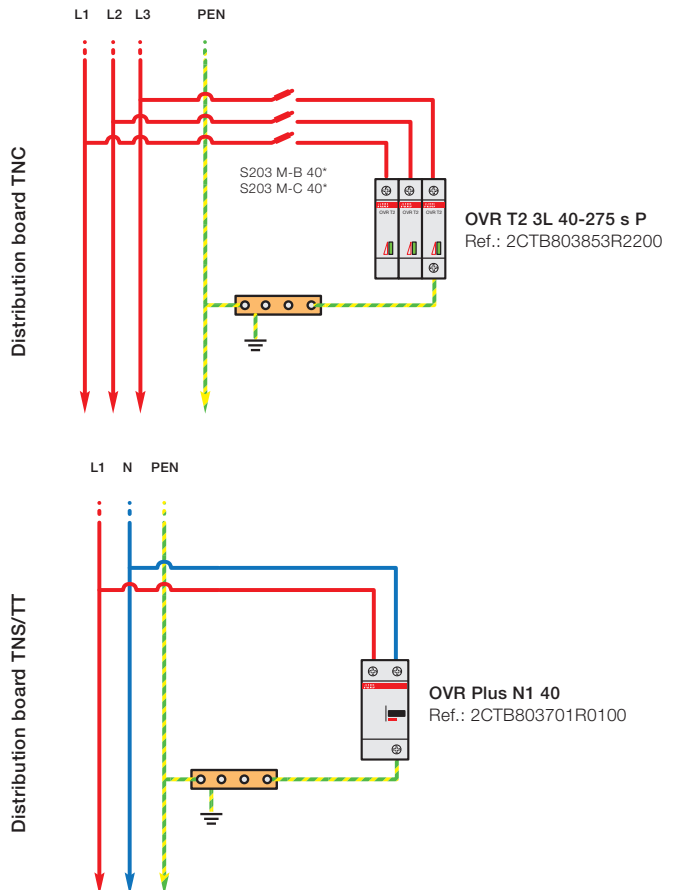



Surge and lightning protection solutions

OVR surge protective devices

OVR Type 1

Single pole	22
TNC 230 V networks	24
TNS/TT 230 V 1Ph+N networks	26
TNS/TT 230 V 3Ph+N networks	28
Single pole neutral	30

OVR Type 1+2

Single pole	32
TNC 230 V networks	34
TNS/TT 230 V 1Ph+N and 3Ph+N networks	36

OVR Type 2

Single pole 57 V networks	38
Single pole 120 V and 230 V networks	40
Single pole 230 V networks	42
Single pole 400 V networks	44
TNC 230 V networks	46
TNC 400 V networks	48
TNS 230 V networks	50
TNS 400 V networks	52
TNS/TT 230 V 1Ph+N networks	54
TNS/TT 230 V 3Ph+N networks	56
TNS/TT 400 V 3Ph+N networks	58

OVR Type 3

TNS/TT 230 V networks	60
-----------------------	----

OVR Plus - Autoprotected

TNS/TT 230 V networks	62
-----------------------	----

OVR PV

Photovoltaic networks	64
-----------------------	----

OVR WT

Wind turbine networks	66
-----------------------	----

OVR TC

Data networks	68
---------------	----

LOVOS surge arresters

LOVOS 5

Single pole	70
-------------	----

LOVOS 10

Single pole	72
-------------	----

OPR external air terminal lightning protection

30 μ s and 60 μ s efficiency	74
--------------------------------------	----

OVR Type 1 surge protective devices

Single pole



OVR T1 25-255

Description

Type 1 and Type 1+2 surge protective devices are designed to discharge high current surges without any destruction of the installation. These surge protective devices are characterized by their capacity to withstand impulse current with 10/350 μ s wave form which simulate natural lightning current.

Type 1+2 ABB surge protective devices have a high impulse current withstand capacity with ensuring a low protection level (U_p).

Type 1 and Type 1+2 SPDs can be installed at the entrance in the main switch board for a global protection of the electrical installation.

Ordering details

Nb of poles	Impulse current limp 10/350 kA	Follow current interrupting rating lfi kA	Voltage protection level U_p kV	Nominal voltage U_n V	Max. cont. operating voltage U_c V	Type	Order code	EAN code	Weight Pkg (1 pce) kg
								3660308	

Follow current interrupting rating 7 kA

1	25	7	2.5	230/400	255	OVR T1 25-255-7	2CTB815101R8700	514110	0.16
---	----	---	-----	---------	-----	-----------------	-----------------	--------	------

Follow current interrupting rating 50 kA

1	25	50	2.5	400/690	440	OVR T1 25-440-50	2CTB815101R9300	514929	0.31
1	25	50	2.5	230/400	255	OVR T1 25-255	2CTB815101R0100	510877	0.31
2	25	50	2.5	230/400	255	OVR T1 2L 25-255	2CTB815101R1200	510891	0.63
2	25	50	2.5	230/400	255	OVR T1 2L 25-255 TS	2CTB815101R1100	510945	0.64

Main dimensions mm

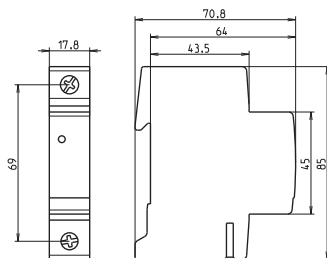

OVR T1 25-255-7

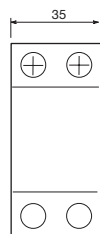

OVR T1 25-440-50

OVR T1 25-255

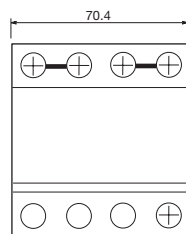

OVR T1 2L 25-255

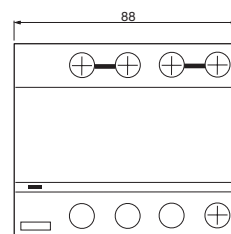

OVR T1 2L 25-255 TS

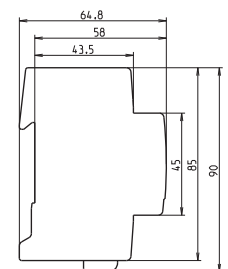





Type	Width	
	mm	inches
OVR T1 25-255-7	17.8	0.70
OVR T1 25-440-50	35.0	1.38
OVR T1 25-255	35.0	1.38
OVR T1 2L 25-255	70.4	2.77
OVR T1 2L 25-255 TS	88.0	3.46

OVR Type 1 surge protective devices

Single pole

General technical data

Types		OVR T1 25-255-7	OVR T1 25-440-50	OVR T1 25-255	OVR T1 2L 25-255 OVR T1 2L 25-255 TS
	with auxiliary contact (TS)	-	-	-	-
Technology		Spark-gap	Spark-gap	Spark-gap	Spark-gap
Wiring diagram					
Electrical features					
Standard		IEC 61643-1 / EN 61643-11			
Type / test class		T1 / I	T1 / I	T1 / I	T1 / I
Protected lines		1	1	1	2
Types of networks		TNC / TNS / TT	IT / TNC / TNS / TT	TNC / TNS / TT	TNS
Type of current		AC	AC	AC	AC
Nominal voltage U_n	V	230 / 400	400 / 690	230 / 400	230 / 400
Maximum continuous operating voltage U_c	V	255	440	255	255
Maximum impulse current I_{imp} (10/350)	kA	25	25	25	25
Maximum impulse current Tot. I_{imp} (10/350)	kA	25	25	25	50
Nominal discharge current I_n (8/20)	kA	25	25	25	25
Follow current interrupting rating I_{fi}	kA	7	50	50	50
Voltage protection level U_p at I_n	kV	≤ 2.5	≤ 2.5	≤ 2.5	≤ 2.5
Voltage protection level U_p at 3 kA	kV	≤ 0.9	≤ 1.3	≤ 0.9	≤ 0.9
TOV (Temporary overvoltage) withstand U_t (L-N: 5 s / N-PE: 200 ms)	V	650 / -	690 / -	450 / -	450 / -
Response time	ns	≤ 100	≤ 100	≤ 100	≤ 100
Residual current IPE	µA	1000	10	10	10
Short-circuit withstand capability I_{sc}	kA	50	50	50	50
Backup protection					
Fuse (gG - gL)	A	≤ 125	≤ 125	≤ 125	≤ 125
Circuit breaker (B or C curve)	A	≤ 125	≤ 125	≤ 125	≤ 125
Pluggable cartridge		No	No	No	No
Integrated thermal disconnect		-	-	-	-
State indicator		Yes	No	No	No
Safety reserve		No	No	No	No
Auxiliary contact		No	No	No	No
Installation					
Wire range (L, N, PE)					
Solid wire	mm ²	2.5...50	2.5...50	2.5...50	2.5...50
Stranded wire	mm ²	2.5...35	2.5...35	2.5...35	2.5...35
Stripping length (L, N, PE)	mm	15	15	15	15
Tightening torque (L, N, PE)	Nm	3.5	3.5	3.5	3.5
Auxiliary contact (TS)					
Contact complement		-	-	-	1 NO - 1 NC
Minimum load		-	-	-	12 V DC - 10 mA
Maximum load		-	-	-	250 V AC - 1 A
Connection cross-section	mm ²	-	-	-	1.5
Miscellaneous characteristics					
Stocking and operating temperature	°C	-40 to +80	-40 to +80	-40 to +80	-40 to +80
Degree of protection		IP20	IP20	IP20	IP20
Fire resistance according to UL 94		V0	V0	V0	V0
Dimensions					
height x width x depth	mm	85 x 17.8 x 70.8	90 x 35 x 64.8	90 x 35 x 64.8	90 x 70.4 x 64.8
	inches	3.34 x 0.70 x 2.78	3.54 x 1.38 x 2.55	3.54 x 1.38 x 2.55	3.54 x 2.77 x 2.55
with auxiliary contact (TS)					
height x width x depth	mm	-	-	-	90 x 88 x 64.8
	inches	-	-	-	3.54 x 3.46 x 2.55

OVR Type 1 surge protective devices TNC 230 V networks

3



OVR T1 3L 25-255

Description

Type 1 and Type 1+2 surge protective devices are designed to discharge high current surges without any destruction of the installation. These surge protective devices are characterized by their capacity to withstand impulse current with 10/350 μ s wave form which simulate natural lightning current.

Type 1+2 ABB surge protective devices have a high impulse current withstand capacity with ensuring a low protection level (U_p).

Type 1 and Type 1+2 SPDs can be installed at the entrance in the main switch board for a global protection of the electrical installation.

Ordering details

Nb of poles	Impulse current I_{imp} 10/350 kA	Follow current interrupting rating I_{fc} kA	Voltage protection level U_p kV	Nominal voltage U_n V	Max. cont. operating voltage U_c V	Type	Order code	EAN code	Weight Pkg (1 pce) kg
								3660308	

Follow current interrupting rating 50 kA

3	25	50	2.5	230/400	255	OVR T1 3L 25-255	2CTB815101R1300	510907	0.94
3	25	50	2.5	230/400	255	OVR T1 3L 25-255 TS	2CTB815101R0600	510952	1.00

Main dimensions mm

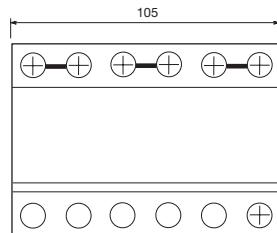

OVR T1 3L 25-255

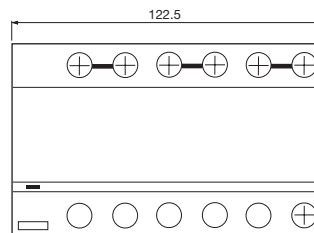

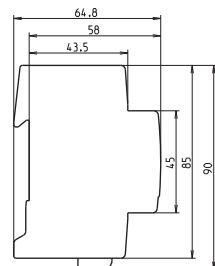

OVR T1 3L 25-255 TS



Type	Width	
	mm	inches
OVR T1 3L 25-255	105.0	4.13
OVR T1 3L 25-255 TS	122.5	4.82

OVR Type 1 surge protective devices TNC 230 V networks

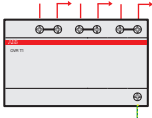
General technical data

Types	OVR T1 3L 25-255	-
with auxiliary contact (TS)	-	OVR T1 3L 25-255 TS
Technology	Spark-gap	Spark-gap
Wiring diagram		
Electrical features		
Standard	IEC 61643-1 / EN 61643-11	
Type / test class	T1 / I	T1 / I
Protected lines	3	3
Types of networks	TNC	TNC
Type of current	AC	AC
Nominal voltage Un	V 230 / 400	230 / 400
Maximum continuous operating voltage Uc	V 255	255
Maximum impulse current Iimp (10/350)	kA 25	25
Maximum impulse current Tot. Iimp (10/350)	kA 75	75
Nominal discharge current In (8/20)	kA 25	25
Follow current interrupting rating I _{fi}	kA 50	50
Voltage protection level Up at In	kV ≤ 2.5	≤ 2.5
Voltage protection level Up at 3 kA	kV ≤ 0.9	≤ 0.9
TOV (Temporary overvoltage) withstand Ut (L-N: 5 s / N-PE: 200 ms)	V 450 / -	450 / -
Response time	ns ≤ 100	≤ 100
Residual current IPE	µA 10	10
Short-circuit withstand capability I _{sc}	kA 50	50
Backup protection		
Fuse (gG - gL)	A ≤ 125	≤ 125
Circuit breaker (B or C curve)	A ≤ 125	≤ 125
Pluggable cartridge	No	No
Integrated thermal disconnect	-	-
State indicator	No	Yes
Safety reserve	No	No
Auxiliary contact	No	Yes
Installation		
Wire range (L, N, PE)		
Solid wire	mm ² 2.5...50	2.5...50
Stranded wire	mm ² 2.5...35	2.5...35
Stripping length (L, N, PE)	mm 15	15
Tightening torque (L, N, PE)	Nm 3.5	3.5
Auxiliary contact (TS)		
Contact complement	-	1 NO - 1 NC
Minimum load	-	12 V DC - 10 mA
Maximum load	-	250 V AC - 1 A
Connection cross-section	mm ² -	1.5
Miscellaneous characteristics		
Stocking and operating temperature	°C -40 to +80	-40 to +80
Degree of protection	IP20	IP20
Fire resistance according to UL 94	V0	V0
Dimensions		
height x width x depth	mm 90 x 105 x 64.8	-
	inches 3.54 x 4.13 x 2.55	-
with auxiliary contact (TS)		
height x width x depth	mm -	90 x 122.5 x 64.8
	inches -	3.54 x 4.82 x 2.55

OVR Type 1 surge protective devices TNS/TT 230 V 1Ph+N networks

3



OVR T1 1N 25-255

Description

Type 1 and Type 1+2 surge protective devices are designed to discharge high current surges without any destruction of the installation. These surge protective devices are characterized by their capacity to withstand impulse current with 10/350 μ s wave form which simulate natural lightning current.

Type 1+2 ABB surge protective devices have a high impulse current withstand capacity with ensuring a low protection level (U_p).

Type 1 and Type 1+2 SPDs can be installed at the entrance in the main switch board for a global protection of the electrical installation.

Ordering details

Nb of poles	Impulse current I_{imp} 10/350 kA	Follow current interrupting rating I_{fi} kA	Voltage protection level U_p kV	Nominal voltage U_n V	Max. cont. operating voltage U_c V	Type	Order code	EAN code	Weight Pkg (1 pce) kg
								3660308	

Follow current interrupting rating 50 kA

1+1	25	50	2.5	230/400	255	OVR T1 1N 25-255	2CTB815101R1500	510921	0.53
1+1	25	50	2.5	230/400	255	OVR T1 1N 25-255 TS	2CTB815101R1000	510976	0.64

Main dimensions mm

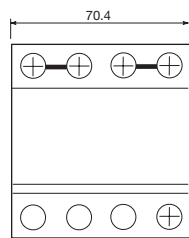

OVR T1 1N 25-255

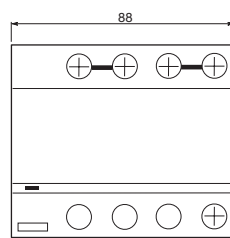

OVR T1 1N 25-255 TS

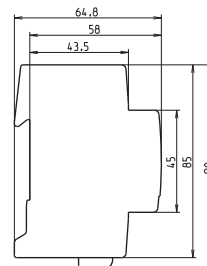

Type	Width	
	mm	inches
OVR T1 1N 25-255	70.4	2.77
OVR T1 1N 25-255 TS	88.0	3.46

OVR Type 1 surge protective devices

TNS/TT 230 V 1Ph+N networks

General technical data

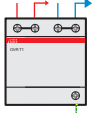
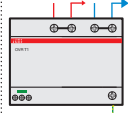
Types		OVR T1 1N 25-255	-
	with auxiliary contact (TS)	-	OVR T1 1N 25-255 TS
Technology		Spark-gap	Spark-gap
Wiring diagram			
Electrical features			
Standard		IEC 61643-1 / EN 61643-11	
Type / test class		T1 / I	T1 / I
Protected lines		1+1	1+1
Types of networks		TNS / TT	TNS / TT
Type of current		AC	AC
Nominal voltage U_n	V	230 / 400	230 / 400
Maximum continuous operating voltage U_c	V	255	255
Maximum impulse current I_{imp} (10/350)	kA	25	25
Maximum impulse current Tot. I_{imp} (10/350)	kA	50	50
Nominal discharge current I_n (8/20)	kA	25	25
Follow current interrupting rating I_{fi}	kA	50	50
Voltage protection level U_p at I_n (L-N/N-PE/L-PE)	kV	2.5 / - / 2.5	2.5 / - / 2.5
Voltage protection level U_p at 3 kA (L-N/N-PE/L-PE)	kV	0.9 / - / 0.9	0.9 / - / 0.9
TOV (Temporary overvoltage) withstand U_t (L-N: 5 s / N-PE: 200 ms)	V	450 / 1200	450 / 1200
Response time	ns	≤ 100	≤ 100
Residual current IPE	μA	10	10
Short-circuit withstand capability I_{sc}	kA	50	50
Backup protection			
Fuse (gG - gL)	A	≤ 125	≤ 125
Circuit breaker (B or C curve)	A	≤ 125	≤ 125
Pluggable cartridge		No	No
Integrated thermal disconnect		-	-
State indicator		No	Yes
Safety reserve		No	No
Auxiliary contact		No	Yes
Installation			
Wire range (L, N, PE)			
Solid wire	mm ²	2.5...50	2.5...50
Stranded wire	mm ²	2.5...35	2.5...35
Stripping length (L, N, PE)	mm	15	15
Tightening torque (L, N, PE)	Nm	3.5	3.5
Auxiliary contact (TS)			
Contact complement		-	1 NO - 1 NC
Minimum load		-	12 V DC - 10 mA
Maximum load		-	250 V AC - 1 A
Connection cross-section	mm ²	-	1.5
Miscellaneous characteristics			
Stocking and operating temperature	°C	-40 to +80	-40 to +80
Degree of protection		IP20	IP20
Fire resistance according to UL 94		V0	V0
Dimensions			
height x width x depth	mm	90 x 70.4 x 64.8	-
	inches	3.54 x 2.77 x 2.55	-
with auxiliary contact (TS)			
height x width x depth	mm	-	90 x 88 x 64.8
	inches	-	3.54 x 3.46 x 2.55

OVR Type 1 surge protective devices TNS/TT 230 V 3Ph+N networks

3



OVR T1 3N 25-255-7

Description

Type 1 and Type 1+2 surge protective devices are designed to discharge high current surges without any destruction of the installation. These surge protective devices are characterized by their capacity to withstand impulse current with 10/350 μ s wave form which simulate natural lightning current.

Type 1+2 ABB surge protective devices have a high impulse current withstand capacity with ensuring a low protection level (U_p).

Type 1 and Type 1+2 SPDs can be installed at the entrance in the main switch board for a global protection of the electrical installation.

Ordering details

Nb of poles	Impulse current limp 10/350 kA	Follow current interrupting rating lfi kA	Voltage protection level U_p kV	Nominal voltage U_n V	Max. cont. operating voltage U_c V	Type	Order code	EAN code	Weight Pkg (1 pce) kg
								3660308	

Follow current interrupting rating 50 kA

4	25	50	2.5	230/400	255	OVR T1 4L 25-255	2CTB815101R1400	510914	1.16
4	25	50	2.5	230/400	255	OVR T1 4L 25-255 TS	2CTB815101R0800	510969	1.26
3+1	25	50	2.5	230/400	255	OVR T1 3N 25-255	2CTB815101R1600	510938	1.16
3+1	25	50	2.5	230/400	255	OVR T1 3N 25-255 TS	2CTB815101R0700	510983	1.26

Follow current interrupting rating 7 kA

3+1	25	7	2.5	230/400	255	OVR T1 3N 25-255-7	2CTB815101R8800	514127	0.84
-----	----	---	-----	---------	-----	--------------------	-----------------	--------	------

Main dimensions mm

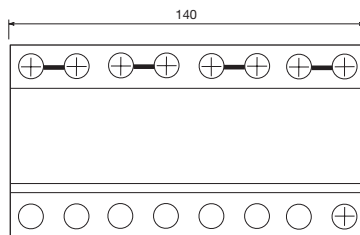

OVR T1 4L 25-255
OVR T1 3N 25-255

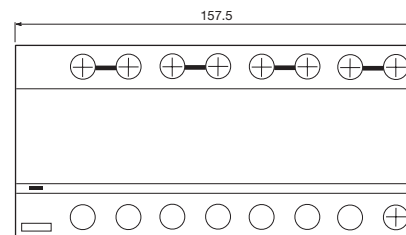

OVR T1 4L 25-255 TS
OVR T1 3N 25-255 TS

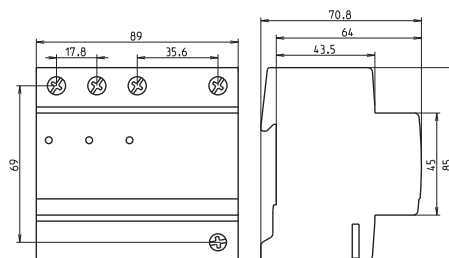
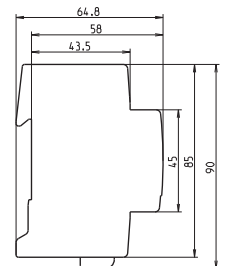

OVR T1 3N 25-255-7

Type	Width	
	mm	inches
OVR T1 4L 25-255	140.0	5.5
OVR T1 4L 25-255 TS	157.5	6.2
OVR T1 3N 25-255	140.0	5.6
OVR T1 3N 25-255 TS	157.5	6.3
OVR T1 3N 25-255-7	89.0	3.5

OVR Type 1 surge protective devices

TNS/TT 230 V 3Ph+N networks

General technical data

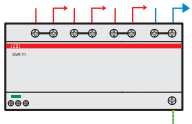
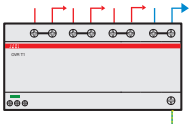
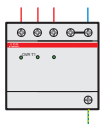
Types		OVR T1 4L 25-255 OVR T1 4L 25-255 TS	OVR T1 3N 25-255 OVR T1 3N 25-255 TS	OVR T1 3N 25-255-7 -
Technology	with auxiliary contact (TS)	Spark-gap	Spark-gap	Spark-gap
Wiring diagram				
Electrical features				
Standard		IEC 61643-1 / EN 61643-11		
Type / test class		T1 / I	T1 / I	T1 / I
Protected lines		4	3+1	3+1
Types of networks		TNS	TNS / TT	TNS / TT
Type of current		AC	AC	AC
Nominal voltage Un	V	230 / 400	230 / 400	230 / 400
Maximum continuous operating voltage Uc	V	255	255	255
Maximum impulse current Iimp (10/350)	kA	25	25	25
Maximum impulse current Tot. Iimp (10/350)	kA	100	100	100
Nominal discharge current In (8/20)	kA	25	25	25
Follow current interrupting rating I _{fi}	kA	50	50	7
Voltage protection level Up at In (L-N/N-PE/L-PE)	kV	≤ 2.5	2.5 / 2.5 / 2.5	2.0 / 2.0 / 2.0
Voltage protection level Up at 3 kA (L-N/N-PE/L-PE)	kV	≤ 0.9	0.9 / 0.9 / 0.9	0.9 / 0.9 / 0.9
TOV (Temporary overvoltage) withstand Ut (L-N: 5 s / N-PE: 200 ms)	V	450 / -	450 / 1200	650 / 1200
Response time	ns	≤ 100	≤ 100	≤ 100
Residual current IPE	µA	10	10	1000
Short-circuit withstand capability I _{sc}	kA	50	50	50
Backup protection				
Fuse (gG - gL)	A	≤ 125	≤ 125	≤ 125
Circuit breaker (B or C curve)	A	≤ 125	≤ 125	≤ 125
Pluggable cartridge		No	No	No
Integrated thermal disconnect		-	-	-
State indicator		Yes (TS option)	Yes (TS option)	Yes
Safety reserve		No	No	No
Auxiliary contact		Yes (TS option)	Yes (TS option)	No
Installation				
Wire range (L, N, PE)				
Solid wire	mm ²	2.5...50	2.5...50	2.5...50
Stranded wire	mm ²	2.5...35	2.5...35	2.5...35
Stripping length (L, N, PE)	mm	15	15	15
Tightening torque (L, N, PE)	Nm	3.5	3.5	3.5
Auxiliary contact (TS)				
Contact complement		1 NO - 1 NC	1 NO - 1 NC	-
Minimum load		12 V DC - 10 mA	12 V DC - 10 mA	-
Maximum load		250 V AC - 1 A	250 V AC - 1 A	-
Connection cross-section	mm ²	1.5	1.5	-
Miscellaneous characteristics				
Stocking and operating temperature	°C	-40 to +80	-40 to +80	-40 to +80
Degree of protection		IP20	IP20	IP20
Fire resistance according to UL 94		V0	V0	V0
Dimensions				
height x width x depth	mm	90 x 140 x 64.8	90 x 140 x 64.8	85 x 89 x 70.6
	inches	3.54 x 5.51 x 2.55	3.54 x 5.51 x 2.55	3.35 x 3.50 x 2.78
with auxiliary contact (TS)				
height x width x depth	mm	90 x 157.5 x 64.8	90 x 157.5 x 64.8	-
	inches	3.54 x 6.20 x 2.55	3.54 x 6.20 x 2.55	-

OVR Type 1 surge protective devices

Single pole neutral



OVR T1 100 N

Description

Type 1 and Type 1+2 surge protective devices are designed to discharge high current surges without any destruction of the installation. These surge protective devices are characterized by their capacity to withstand impulse current with 10/350 μ s wave form which simulate natural lightning current.

Type 1+2 ABB surge protective devices have a high impulse current withstand capacity with ensuring a low protection level (U_p).

Type 1 and Type 1+2 SPDs can be installed at the entrance in the main switch board for a global protection of the electrical installation.

Ordering details

Nb of poles	Impulse current I_{imp} 10/350 kA	Follow current interrupting rating I_{fi} kA	Voltage protection level U_p kV	Nominal voltage U_n V	Max. cont. operating voltage U_c V	Type	Order code	EAN code	Weight Pkg (1 pce) kg
								3660308	

Type 1 Neutral

1	25	-	4	400/690	690	OVR T1 25 N	2CTB815101R9700	517043	0.15
1	50	-	1.5	230/400	255	OVR T1 50 N	2CTB815101R0400	510853	0.29
1	100	-	2	230/400	255	OVR T1 100 N	2CTB815101R0500	510860	0.29

Main dimensions mm

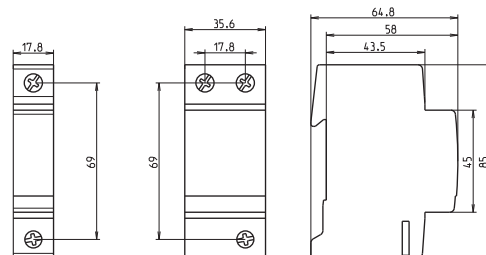

OVR T1 25 N

OVR T1 50/100 N



Type	Width	
	mm	inches
OVR T1 25 N	17.8	0.70
OVR T1 50 N	35.6	1.40
OVR T1 100 N	35.6	1.40

OVR Type 1 surge protective devices

Single pole neutral

General technical data

NEW

Types	OVR T1 25 N	OVR T1 50 N	OVR T1 100 N
with auxiliary contact (TS)	-	-	-
Technology	Gas discharge tube (GDT)	Gas discharge tube (GDT)	Gas discharge tube (GDT)
Wiring diagram			
Electrical features			
Standard	IEC 61643-1 / EN 61643-11		
Type / test class	T1 / I	T1 / I	T1 / I
Protected lines	1	1	1
Types of networks	Neutral	Neutral	Neutral
Type of current	AC	AC	AC
Nominal voltage Un	V 400 / 690	230 / 400	230 / 400
Maximum continuous operating voltage Uc	V 690	255	255
Maximum impulse current Iimp (10/350)	kA 25	50	100
Maximum impulse current Tot. Iimp (10/350)	kA 25	50	100
Nominal discharge current In (8/20)	kA 25	25	25
Follow current interrupting rating I _{fi}	kA 0.1	0.1	0.1
Voltage protection level Up at In	kV ≤ 4	≤ 1.5	≤ 2
Voltage protection level Up at 3 kA	kV -	0.9	0.9
TOV (Temporary overvoltage) withstand Ut (L-N: 5 s / N-PE: 200 ms)	V - / 1200	- / 1200	- / 1200
Response time	ns ≤ 100	≤ 100	≤ 100
Residual current IPE	µA 10	10	10
Short-circuit withstand capability I _{sc}	kA 50	50	50
Backup protection			
Fuse (gG - gL)	A -	-	-
Circuit breaker (B or C curve)	A -	-	-
Pluggable cartridge	No	No	No
Integrated thermal disconnect	-	-	-
State indicator	No	No	No
Safety reserve	No	No	No
Auxiliary contact	No	No	No
Installation			
Wire range (L, N, PE)			
Solid wire	mm ² 2.5...50	2.5...50	2.5...50
Stranded wire	mm ² 2.5...35	2.5...35	2.5...35
Stripping length (L, N, PE)	mm 15	15	15
Tightening torque (L, N, PE)	Nm 3.5	3.5	3.5
Auxiliary contact (TS)			
Contact complement	-	-	-
Minimum load	-	-	-
Maximum load	-	-	-
Connection cross-section	mm ² -	-	-
Miscellaneous characteristics			
Stocking and operating temperature	°C -40 to +80	-40 to +80	-40 to +80
Degree of protection	IP20	IP20	IP20
Fire resistance according to UL 94	V0	V0	V0
Dimensions			
height x width x depth	mm 85 x 17.8 x 64.8	85 x 35.6 x 64.8	85 x 35.6 x 64.8
	inches 3.35 x 0.70 x 2.55	3.35 x 1.40 x 2.55	3.35 x 1.40 x 2.55
with auxiliary contact (TS)			
height x width x depth	mm -	-	-
	inches -	-	-

OVR Type 1+2 surge protective devices

Single pole



OVR T1+2 15-255-7

Description

Type 1 and Type 1+2 surge protective devices are designed to discharge high current surges without any destruction of the installation. These surge protective devices are characterized by their capacity to withstand impulse current with 10/350 μ s wave form which simulate natural lightning current.

Type 1+2 ABB surge protective devices have a high impulse current withstand capacity with ensuring a low protection level (U_p).

Type 1 and Type 1+2 SPDs can be installed at the entrance in the main switch board for a global protection of the electrical installation.

Ordering details

Nb of poles	Impulse current I_{imp} 10/350 kA	Max. discharge current I_{max} 8/20 kA	Follow current interrupting rating I_{fi} kA	Voltage protection level U_p kV	Nominal voltage U_n V	Max. cont. operating voltage U_c V	Type	Order code	EAN code	Weight Pkg (1 pce) kg
1	7	70	-	1.4	230/400	275	OVR T1+2 7-275s P	2CTB815101R3900	513403	0.15
1	15	140	-	1.4	230/400	440	OVR HL 15-440s P TS	2CTB815201R0800	509802	0.32
1	25	60	15	1.5	230/400	255	OVR T1+2 25-255 TS	2CTB815101R0300	510884	0.27

Follow current interrupting rating 7 kA

1	15	60	7	1.7	230/400	255	OVR T1+2 15-255-7	2CTB815101R8900	514134	0.14
---	----	----	---	-----	---------	-----	-------------------	-----------------	--------	------

Main dimensions mm

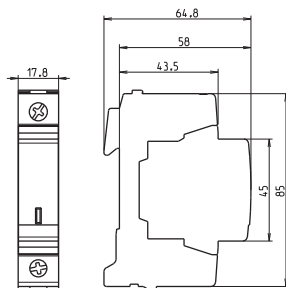

OVR T1+2 7-275s P

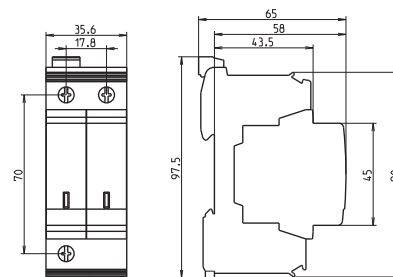

OVR HL 15-440s P TS

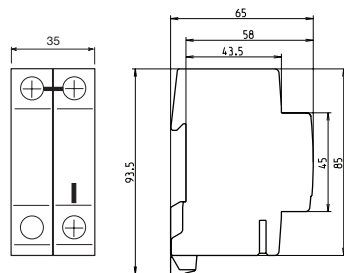

OVR T1+2 25-255 TS

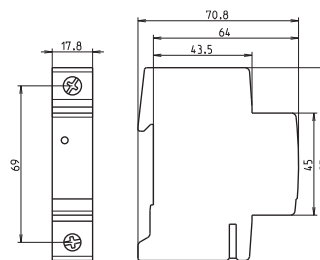





OVR T1+2 15-255-7

Type	Width	
	mm	inches
OVR T1+2 7-275s P	17.8	0.70
OVR HL 15-440s P TS	35.6	1.40
OVR T1+2 25-255 TS	35.0	1.38
OVR T1+2 15-255-7	17.8	0.70

OVR Type 1+2 surge protective devices

Single pole

General technical data

Types	OVR T1+2 7-275s P	-	-	OVR T1+2 15-255-7
	with auxiliary contact (TS)	-	OVR HL 15-440s P TS	OVR T1+2 25-255 TS
Technology	Varistor	Varistor	Spark-gap + varistor	Spark-gap
Wiring diagram				
Electrical features	IEC 61643-1 / EN 61643-11			
Standard	IEC 61643-1 / EN 61643-11			
Type / test class	T1+T2 / I+II	T1+T2 / I+II	T1+T2 / I+II	T1+T2 / I+II
Protected lines	1	1	1	1
Types of networks	TNC / TNS / TT	IT / TNC / TNS / TT	TNC / TNS / TT	TNC / TNS / TT
Type of current	AC	AC	AC	AC
Nominal voltage Un	V 230 / 400	230 / 400	230 / 400	230 / 400
Maximum continuous operating voltage Uc	V 275	440	255	255
Maximum impulse current Iimp (10/350)	kA 7	15	25	15
Maximum impulse current Tot. Iimp (10/350)	kA 7	15	25	15
Maximum discharge current Imax (8/20)	kA 70	100	60	60
Nominal discharge current In (8/20)	kA 7	5	25	15
Follow current interrupting rating Ifi	kA -	-	15	7
Voltage protection level Up at In (L-N/N-PE/L-PE)	kV - / - / 1.4	- / - / 1.4	- / - / 1.5	- / - / 1.7
Voltage protection level Up at 3 kA (L-N/N-PE/L-PE)	kV - / - / 0.8	- / - / 1.2	- / - / 1.0	- / - / 0.9
TOV (Temporary overvoltage) withstand Ut (L-N: 5 s / N-PE: 200 ms)	V 334 / -	440 / -	334 / -	650 / -
Response time	ns ≤ 25	≤ 25	≤ 100	≤ 100
Residual current IPE	µA 50	50	10	1000
Short-circuit withstand capability Iscor	kA 50	50	50	50
Backup protection				
Fuse (gG - gL)	A ≤ 50	≤ 50	≤ 125	≤ 125
Circuit breaker (B or C curve)	A ≤ 50	≤ 50	≤ 125	≤ 125
Pluggable cartridge	Yes	Yes	No	No
Integrated thermal disconnecter	Yes	Yes	Yes	-
State indicator	Yes	Yes	Yes	Yes
Safety reserve	Yes	Yes	No	No
Auxiliary contact	No	Yes	Yes	No
Installation				
Wire range (L, N, PE)				
Solid wire	mm ² 2.5...25	2.5...50	2.5...50	2.5...50
Stranded wire	mm ² 2.5...16	2.5...35	2.5...35	2.5...35
Stripping length (L, N, PE)	mm 12.5	15	15	15
Tightening torque (L, N, PE)	Nm 2	3.5	3.5	3.5
Auxiliary contact (TS)				
Contact complement	-	1 NO - 1 NC	1 NO - 1 NC	-
Minimum load	-	12 V DC - 10 mA	12 V DC - 10 mA	-
Maximum load	-	250 VAC - 1 A	250 VAC - 1 A	-
Connection cross-section	mm ² -	1.5	1.5	-
Miscellaneous characteristics				
Stocking and operating temperature	°C -40 to +80	-40 to +80	-40 to +80	-40 to +80
Degree of protection	IP20	IP20	IP20	IP20
Fire resistance according to UL 94	V0	V0	V0	V0
Dimensions				
height x width x depth	mm 85 x 17.8 x 64.8	-	-	85 x 17.8 x 70.8
	inches 3.35 x 0.70 x 2.55	-	-	3.35 x 0.70 x 2.79
with auxiliary contact (TS)				
height x width x depth	mm -	90 x 35.6 x 65	93 x 35 x 58	-
	inches -	3.54 x 1.40 x 2.56	3.66 x 1.38 x 2.28	-

OVR Type 1+2 surge protective devices TNC 230 V networks

3



OVR HL 3L 15-440s P TS

Description

Type 1 and Type 1+2 surge protective devices are designed to discharge high current surges without any destruction of the installation. These surge protective devices are characterized by their capacity to withstand impulse current with 10/350 μ s wave form which simulate natural lightning current.

Type 1+2 ABB surge protective devices have a high impulse current withstand capacity with ensuring a low protection level (U_p).

Type 1 and Type 1+2 SPDs can be installed at the entrance in the main switch board for a global protection of the electrical installation.

Ordering details

Nb of poles	Impulse current I_{imp} 10/350 kA	Max. discharge current I_{max} 8/20 kA	Voltage protection level U_p kV	Nominal voltage U_n V	Max. cont. operating voltage U_c V	Type	Order code	EAN code	Weight Pkg (1 pce) kg
3	15	100	1.4	230/400	440	OVR HL 3L 15-440s P TS	2CTB815401R0400	3660308 509833	0.94
3	7	70	1.4	230/400	275	OVR T1+2 3L 7-275s P	2CTB815101R4000	513410	0.48

Main dimensions mm

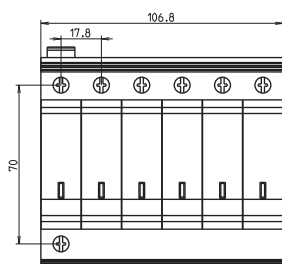

OVR HL 3L 15-440s P TS

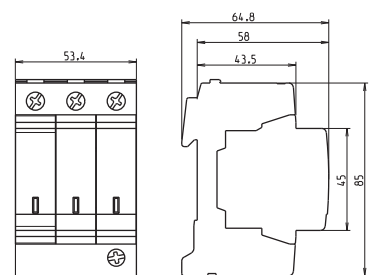
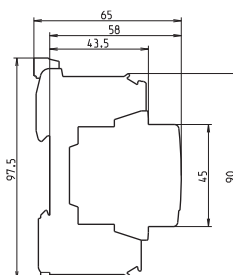



OVR T1+2 3L 7-275s P

Type	Width	
	mm	inches
OVR HL 3L 15-440s P TS	106.8	4.2
OVR T1+2 3L 7-275s P	53.4	2.1

OVR Type 1+2 surge protective devices TNC 230 V networks

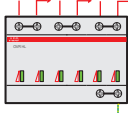
General technical data

Types	-	OVR HL 3L 15-440s P TS	OVR T1+2 3L 7-275s P
with auxiliary contact (TS)			
Technology		Varistor	Varistor
Wiring diagram			
Electrical features			
Standard		IEC 61643-1 / EN 61643-11	
Type / test class		T1+T2 / I+II	T1+T2 / I+II
Protected lines		3	3
Types of networks		IT / TNC	TNC
Type of current		AC	AC
Nominal voltage U_n	V	230 / 400	230 / 400
Maximum continuous operating voltage U_c	V	440	275
Maximum impulse current I_{imp} (10/350)	kA	15	7
Maximum impulse current Tot. I_{imp} (10/350)	kA	45	20
Maximum discharge current I_{max} (8/20)	kA	100	70
Nominal discharge current I_n (8/20)	kA	5	7
Follow current interrupting rating I_{fi}	kA	-	-
Voltage protection level U_p at I_n (L-N/N-PE/L-PE)	kV	- / - / 1.4	- / - / 1.4
Voltage protection level U_p at 3 kA (L-N/N-PE/L-PE)	kV	- / - / 1.2	- / - / 0.8
TOV (Temporary overvoltage) withstand U_t (L-N: 5 s / N-PE: 200 ms)	V	440 / -	334 / -
Response time	ns	≤ 25	≤ 25
Residual current IPE	μA	150	150
Short-circuit withstand capability I_{sc}	kA	50	50
Backup protection			
Fuse (gG - gL)	A	≤ 50	≤ 50
Circuit breaker (B or C curve)	A	≤ 50	≤ 50
Pluggable cartridge		Yes	Yes
Integrated thermal disconnecter		Yes	Yes
State indicator		Yes	Yes
Safety reserve		Yes	Yes
Auxiliary contact		Yes	No
Installation			
Wire range (L, N, PE)			
Solid wire	mm ²	2.5...50	2.5...25
Stranded wire	mm ²	2.5...35	2.5...16
Stripping length (L, N, PE)	mm	15	12.5
Tightening torque (L, N, PE)	Nm	3.5	2
Auxiliary contact (TS)			
Contact complement		1 NO - 1 NC	-
Minimum load		12 V DC - 10 mA	-
Maximum load		250 V AC - 1 A	-
Connection cross-section	mm ²	1.5	-
Miscellaneous characteristics			
Stocking and operating temperature	°C	-40 to +80	-40 to +80
Degree of protection		IP20	IP20
Fire resistance according to UL 94		V0	V0
Dimensions			
height x width x depth	mm	-	85 x 53.4 x 64.8
	inches	-	3.35 x 2.10 x 2.55
with auxiliary contact (TS)			
height x width x depth	mm	90 x 106.8 x 65	-
	inches	3.54 x 4.20 x 2.56	-

OVR Type 1+2 surge protective devices TNS/TT 230 V 1Ph+N and 3Ph+N networks



OVR T1+2 1N 7-275s P

Description

Type 1 and Type 1+2 surge protective devices are designed to discharge high current surges without any destruction of the installation. These surge protective devices are characterized by their capacity to withstand impulse current with 10/350 μ s wave form which simulate natural lightning current.

Type 1+2 ABB surge protective devices have a high impulse current withstand capacity with ensuring a low protection level (U_p).

Type 1 and Type 1+2 SPDs can be installed at the entrance in the main switch board for a global protection of the electrical installation.

Ordering details

Nb of poles	Impulse current I_{imp} 10/350 kA	Max. discharge current I_{max} 8/20 kA	Follow current interrupting rating I_{fi} kA	Voltage protection level U_p kV	Nominal voltage U_n V	Max. cont. operating voltage U_c V	Type	Order code	EAN code	Weight Pkg (1 pce) kg
1+1	7	70	-	1.4	230/400	275	OVR T1+2 1N 7-275s P	2CTB815302R1000	515728	0.32
3+1	7	70	-	1.4	230/400	275	OVR T1+2 3N 7-275s P	2CTB815502R1000	515735	0.63
4	7	70	-	0.9	230/400	275	OVR T1+2 4L 7-275s P	2CTB815101R4100	513427	0.60
4	15	100	-	1.4	230/400	440	OVR HL 4L 15-440s P TS	2CTB815503R0400	509840	1.20

Follow current interrupting rating 7 kA - 2 poles (1Ph+N)

3+1	15	60	7	1.7	230/400	255	OVR T1+2 3N 15-255-7	2CTB815101R9000	514141	0.84
-----	----	----	---	-----	---------	-----	----------------------	-----------------	--------	------

Main dimensions mm

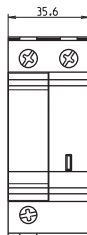

OVR T1+2 1N 7-275s P

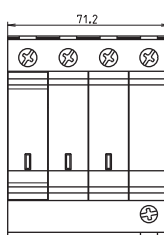

OVR T1+2 3N 7-275s P

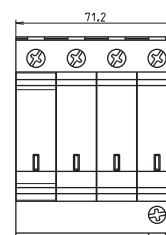

OVR T1+2 4L 7-275s P

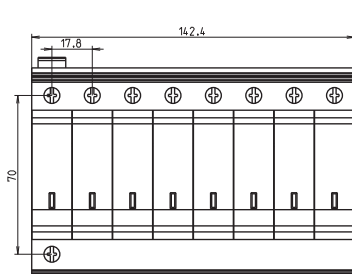
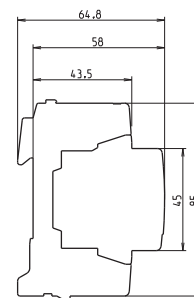

OVR HL 4L15-440s P TS

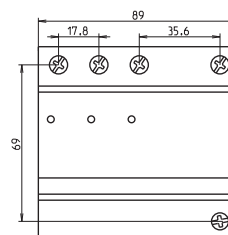
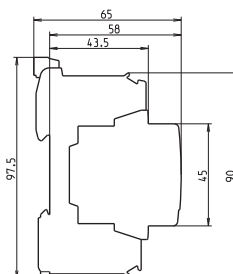

OVR T1+2 3N 15-255-7

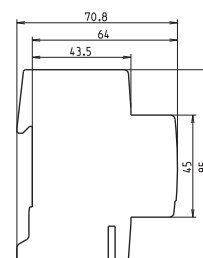



Type	Width	
	mm	inches
OVR T1+2 1N 7-275s P	35.0	1.38
OVR T1+2 3N 7-275s P	71.2	2.80
OVR T1+2 4L 7-275s P	71.2	2.80
OVR HL 4L15-440s P TS	142.4	5.60
OVR T1+2 3N 15-255-7	89.0	3.50

OVR Type 1+2 surge protective devices

TNS/TT 230 V 1Ph+N and 3Ph+N networks

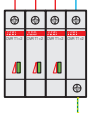
General technical data

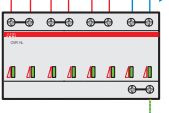
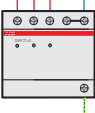
Types		OVR T1+2 1N 7-275s P	OVR T1+2 3N 7-275s P	OVR T1+2 4L 7-275s P	-	OVR T1+2 3N 15-255-7
	with auxiliary contact (TS)	-	-	-	OVR HL 4L 15-440s P TS	-
Technology		Varistor	Varistor	Varistor	Varistor	Spark-gap
Wiring diagram						
Electrical features		IEC 61643-1 / EN 61643-11				
Standard		IEC 61643-1 / EN 61643-11				
Type / test class		T1+T2 / I+II	T1+T2 / I+II	T1+T2 / I+II	T1+T2 / I+II	T1+T2 / I+II
Protected lines		1+1	3+1	4	4	3+1
Types of networks		TNS / TT	TNS / TT	TNS	TNS	TNS / TT
Type of current		AC	AC	AC	AC	AC
Nominal voltage Un	V	230 / 400	230 / 400	230 / 400	230 / 400	230 / 400
Maximum continuous operating voltage Uc	V	275	275	275	440	255
Maximum impulse current Iimp (10/350)	kA	7	7	7	15	15
Maximum impulse current Tot. Iimp (10/350)	kA	15	30	30	60	50
Maximum discharge current Imax (8/20)	kA	70	70	70	100	60
Nominal discharge current In (8/20)	kA	7	7	7	5	15
Follow current interrupting rating Ifi	kA	-	-	-	-	7
Voltage protection level Up at In (L-N/N-PE/L-PE)	kV	0.9 / 1.4 / 1.4	0.9 / 1.4 / 1.4	- / - / 1.4	- / - / 1.4	1.7 / 1.5 / 1.7
Voltage protection level Up at 3 kA (L-N/N-PE/L-PE)	kV	0.8 / 0.8 / 0.8	0.8 / 0.8 / 0.8	- / - / 0.8	- / - / 1.2	0.9 / 0.9 / 0.9
TOV (Temporary overvoltage) withstand Ut (L-N: 5 s / N-PE: 200 ms)	V	334 / 1200	334 / 1200	334 / -	440 / -	650 / 1200
Response time	ns	≤ 25	≤ 25	≤ 25	≤ 25	≤ 100
Residual current IPE	µA	10	10	200	200	1000
Short-circuit withstand capability Iscor	kA	50	50	50	50	50
Backup protection						
Fuse (gG - gL)	A	≤ 50	≤ 50	≤ 50	≤ 50	≤ 125
Circuit breaker (B or C curve)	A	≤ 50	≤ 50	≤ 50	≤ 50	≤ 125
Pluggable cartridge		Yes	Yes	Yes	Yes	No
Integrated thermal disconnect		Yes	Yes	Yes	Yes	-
State indicator		Yes	Yes	Yes	Yes	Yes
Safety reserve		Yes	Yes	Yes	Yes	No
Auxiliary contact		No	No	No	Yes	No
Installation						
Wire range (L, N, PE)						
Solid wire	mm ²	2.5...25	2.5...25	2.5...25	2.5...50	2.5...50
Stranded wire	mm ²	2.5...16	2.5...16	2.5...16	2.5...35	2.5...35
Stripping length (L, N, PE)	mm	12.5	12.5	12.5	15	15
Tightening torque (L, N, PE)	Nm	2	2	2	3.5	3.5
Auxiliary contact (TS)						
Contact complement		-	-	-	1 NO - 1 NC	-
Minimum load		-	-	-	12 V DC - 10 mA	-
Maximum load		-	-	-	250 V AC - 1 A	-
Connection cross-section	mm ²	-	-	-	1.5	-
Miscellaneous characteristics						
Stocking and operating temperature	°C	-40 to +80	-40 to +80	-40 to +80	-40 to +80	-40 to +80
Degree of protection		IP20	IP20	IP20	IP20	IP20
Fire resistance according to UL 94		V0	V0	V0	V0	V0
Dimensions						
height x width x depth	mm	85 x 35 x 64.8	85 x 71.2 x 64.8	85 x 71.2 x 64.8	-	85 x 89 x 70.8
	inches	3.35 x 1.38 x 2.55	3.35 x 2.80 x 2.55	3.35 x 2.80 x 2.55	-	3.35 x 3.50 x 2.79
with auxiliary contact (TS)						
height x width x depth	mm	-	-	-	90 x 142.4 x 65	-
	inches	-	-	-	3.54 x 5.60 x 2.56	-

OVR Type 2 surge protective devices

Single pole 57 V networks



OVR T2 15-75 P

Description

Type 2 surge protective devices are designed to protect electric installations and sensitive equipment against indirect surges with ensuring a low protection level (Up). They are characterized by their capacity to safely discharge current with 8/20 μ s wave form.

Ordering details

Nb of poles	Max. discharge current I_{max} 8/20 kA	Nominal discharge current I_n kA	Voltage protection level U_p kV	Nominal voltage U_n V	Max. cont. operating voltage U_c V	Type	Order code	EAN code	Weight Pkg (1 pce) kg
								3660308	

Type 2 pluggable - U_c 75 V

1	15	5	0.3	57	75	OVR T2 15-75 P	2CTB803851R2800	518446	0.12
1	15	5	0.3	57	75	OVR T2 15-75 P TS	2CTB803851R2700	518453	0.12
2	15	5	0.3	57	75	OVR T2 2L 15-75 P	2CTB803852R1700	518484	0.23
2	15	5	0.3	57	75	OVR T2 2L 15-75 P TS	2CTB803852R1600	518477	0.23

Main dimensions mm

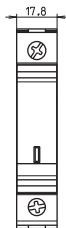

OVR T2 15-75 P

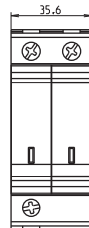

OVR T2 2L 15-75 P

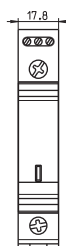
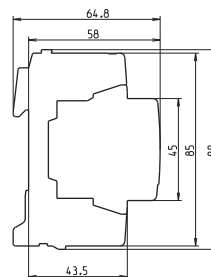

OVR T2 15-75 P TS



OVR T2 2L 15-75 P TS

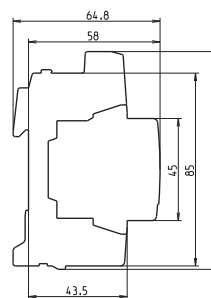





Type	Width	
	mm	inches
OVR T2 15-75 P	17.8	0.70
OVR T2 15-75 P TS	17.8	0.70
OVR T2 2L 15-75 P	35.6	1.40
OVR T2 2L 15-75 P TS	35.6	1.40

OVR Type 2 surge protective devices

Single pole 57 V networks

General technical data

Types		OVR T2 15-75 P	-	OVR T2 2L 15-75 P	-
	with auxiliary contact (TS)	-	OVR T2 15-75 P TS	-	OVR T2 2L 15-75 P TS
Technology		Varistor	Varistor	Varistor	Varistor
Wiring diagram					
Electrical features		IEC 61643-1 / EN 61643-11			
Standard		IEC 61643-1 / EN 61643-11			
Type / test class		T2 / II	T2 / II	T2 / II	T2 / II
Protected lines		1	1	2	2
Types of networks		TNC / TNS / TT	TNC / TNS / TT	TNC / TNS / TT	TNC / TNS / TT
Type of current		AC - DC	AC - DC	AC - DC	AC - DC
Nominal AC voltage Un	V	57	57	57	57
Max. cont. operating AC voltage Uc	V	75	75	75	75
Max. cont. operating DC voltage Uc	V	100	100	100	100
Maximum discharge current I _{max} (8/20)	kA	15	15	15	15
Nominal discharge current I _n (8/20)	kA	5	5	5	5
Voltage protection level U _p at I _n	kV	0.30	0.30	0.30	0.30
Voltage protection level U _p at 3 kA	kV	0.25	0.25	0.25	0.25
TOV (Temporary overvoltage) withstand U _t (L-N: 5 s / N-PE: 200 ms)	V	75 / -	75 / -	75 / -	75 / -
Response time	ns	≤ 25	≤ 25	≤ 25	≤ 25
Residual current IPE	µA	25	25	50	50
Short-circuit withstand capability I _{sc}	kA	50	50	50	50
Backup protection					
Fuse (gG - gL)	A	≤ 16	≤ 16	≤ 16	≤ 16
Circuit breaker (B or C curve)	A	≤ 16	≤ 16	≤ 16	≤ 16
Pluggable cartridge		No	No	No	No
Integrated thermal disconnecter		Yes	Yes	Yes	Yes
State indicator		Yes	Yes	Yes	Yes
Safety reserve		No	No	No	No
Auxiliary contact		No	Yes	No	Yes
Installation					
Wire range (L, N, PE)					
Solid wire	mm ²	2.5...25	2.5...25	2.5...25	2.5...25
Stranded wire	mm ²	2.5...16	2.5...16	2.5...16	2.5...16
Stripping length (L, N, PE)	mm	12.5	12.5	12.5	12.5
Tightening torque (L, N, PE)	Nm	2.5	2.5	2.5	2.5
Auxiliary contact (TS)					
Contact complement		-	1 NO - 1 NC	-	1 NO - 1 NC
Minimum load		-	12 V DC - 10 mA	-	12 V DC - 10 mA
Maximum load		-	250 V AC - 1 A	-	250 V AC - 1 A
Connection cross-section	mm ²	-	1.5	-	1.5
Miscellaneous characteristics					
Stocking and operating temperature	°C	-40 to +80	-40 to +80	-40 to +80	-40 to +80
Degree of protection		IP20	IP20	IP20	IP20
Fire resistance according to UL 94		V0	V0	V0	V0
Dimensions					
height x width x depth	mm	88 x 17.8 x 64.8	-	88 x 35.6 x 64.8	-
	inches	3.46 x 0.70 x 2.55	-	3.46 x 1.40 x 2.55	-
with auxiliary contact (TS)					
height x width x depth	mm	-	96 x 17.8 x 64.8	-	96 x 35.6 x 64.8
	inches	-	3.78 x 0.70 x 2.55	-	3.78 x 1.40 x 2.55

OVR Type 2 surge protective devices

Single pole 120 V and 230 V networks



OVR T2 20-150

Description

Type 2 surge protective devices are designed to protect electric installations and sensitive equipment against indirect surges with ensuring a low protection level (Up). They are characterized by their capacity to safely discharge current with 8/20 μ s wave form.

Ordering details

Nb of poles	Max. discharge current I_{max} 8/20 kA	Nominal discharge current I_n kA	Voltage protection level U_p kV	Nominal voltage U_n V	Max. cont. operating voltage U_c V	Type	Order code	EAN code	Weight Pkg (1 pce) kg
								3660308	

Type 2 unpluggable

1	20	5	1.0	120/240	150	OVR T2 20-150	2CTB804200R0700	518057	0.12
1	40	20	1.4	120/240	150	OVR T2 40-150	2CTB804201R0700	518064	0.12
1	20	5	1.0	230/400	275	OVR T2 20-275	2CTB804200R0100	514882	0.12
1	40	20	1.4	230/400	275	OVR T2 40-275	2CTB804201R0100	514103	0.12

Main dimensions mm

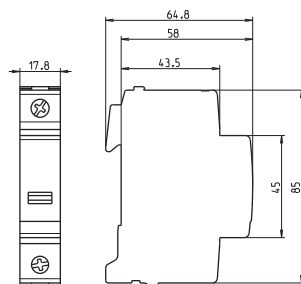





OVR T2 20-150
OVR T2 40-150
OVR T2 20-275
OVR T2 40-275

Type	Width	
	mm	inches
OVR T2 20-150	17.8	0.70
OVR T2 40-150	17.8	0.70
OVR T2 20-275	17.8	0.70
OVR T2 40-275	17.8	0.70

OVR Type 2 surge protective devices

Single pole 120 V and 230 V networks

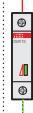
General technical data

Types		OVR T2 20-150	OVR T2 40-150	OVR T2 20-275	OVR T2 40-275
with auxiliary contact (TS)		-	-	-	-
Technology		Varistor	Varistor	Varistor	Varistor
Wiring diagram					
Electrical features		IEC 61643-1 / EN 61643-11			
Standard		IEC 61643-1 / EN 61643-11			
Type / test class		T2 / II	T2 / II	T2 / II	T2 / II
Protected lines		1	1	1	1
Types of networks		TNC / TNS / TT	TNC / TNS / TT	TNC / TNS / TT	TNC / TNS / TT
Type of current		AC	AC	AC	AC
Nominal AC voltage Un	V	120 / 240	120 / 240	230 / 400	230 / 400
Max. cont. operating AC voltage Uc	V	150	150	275	275
Maximum discharge current Imax (8/20)	kA	20	40	20	40
Nominal discharge current In (8/20)	kA	5	20	5	20
Voltage protection level Up at In	kV	1.0	1.4	1.2	1.4
Voltage protection level Up at 3 kA	kV	0.9	0.9	0.9	0.9
TOV (Temporary overvoltage) withstand Ut (L-N: 5 s / N-PE: 200 ms)	V	334 / -	334 / -	334 / -	334 / -
Response time	ns	≤ 25	≤ 25	≤ 25	≤ 25
Residual current IPE	µA	25	25	25	25
Short-circuit withstand capability Iscrc	kA	50	50	50	50
Backup protection					
Fuse (gG - gL)	A	≤ 50	≤ 50	≤ 50	≤ 50
Circuit breaker (B or C curve)	A	≤ 50	≤ 50	≤ 50	≤ 50
Pluggable cartridge		No	No	No	No
Integrated thermal disconnecter		Yes	Yes	Yes	Yes
State indicator		Yes	Yes	Yes	Yes
Safety reserve		No	No	No	No
Auxiliary contact		No	No	No	No
Installation					
Wire range (L, N, PE)					
Solid wire	mm ²	2.5...25	2.5...25	2.5...25	2.5...25
Stranded wire	mm ²	2.5...16	2.5...16	2.5...16	2.5...16
Stripping length (L, N, PE)	mm	12.5	12.2	12.2	12.2
Tightening torque (L, N, PE)	Nm	2.5	2.5	2.5	2.5
Auxiliary contact (TS)					
Contact complement		-	-	-	-
Minimum load		-	-	-	-
Maximum load		-	-	-	-
Connection cross-section	mm ²	-	-	-	-
Miscellaneous characteristics					
Stocking and operating temperature	°C	-40 to +80	-40 to +80	-40 to +80	-40 to +80
Degree of protection		IP20	IP20	IP20	IP20
Fire resistance according to UL 94		V0	V0	V0	V0
Dimensions					
height x width x depth	mm	85 x 17.8 x 64.8	85 x 17.8 x 64.8	85 x 17.8 x 64.8	85 x 17.8 x 64.8
	inches	3.35 x 0.70 x 2.55	3.35 x 0.70 x 2.55	3.35 x 0.70 x 2.55	3.35 x 0.70 x 2.55

OVR Type 2 surge protective devices

Single pole 230 V networks



OVR T2 40-275 P

Description

Type 2 surge protective devices are designed to protect electric installations and sensitive equipment against indirect surges with ensuring a low protection level (Up). They are characterized by their capacity to safely discharge current with 8/20 μ s wave form.

Ordering details

Nb of poles	Max. discharge current I _{max} 8/20 kA	Nominal discharge current I _n kA	Voltage protection level U _p kV	Nominal voltage U _n V	Max. cont. operating voltage U _c V	Type	Order code	EAN code	Weight Pkg (1 pce) kg
-------------	----------------------------------------------------------	---------------------------------------------------	--------------------------------------------------	----------------------------------------	-----------------------------------------------------	------	------------	----------	--------------------------------

Type 2 pluggable - U_c 275 V

1	15	5	1.0	230/400	275	OVR T2 15-275 P	2CTB803851R2400	512840	0.12
1	40	20	1.4	230/400	275	OVR T2 40-275 P	2CTB803851R2300	512833	0.12
1	40	20	1.4	230/400	275	OVR T2 40-275 P TS	2CTB803851R1700	514363	0.12
1	40	20	1.4	230/400	275	OVR T2 40-275s P	2CTB803851R2000	512826	0.12
1	40	20	1.4	230/400	275	OVR T2 40-275s P TS	2CTB803851R1400	512802	0.12
1	70	30	1.5	230/400	275	OVR T2 70-275s P	2CTB803851R1900	512819	0.12
1	70	30	1.5	230/400	275	OVR T2 70-275s P TS	2CTB803851R1300	512796	0.12

Type 2 Neutral

1	70	30	1.4	230/400	255	OVR T2 70 N P	2CTB803953R1900	516862	0.12
---	----	----	-----	---------	-----	---------------	-----------------	--------	------

Main dimensions mm

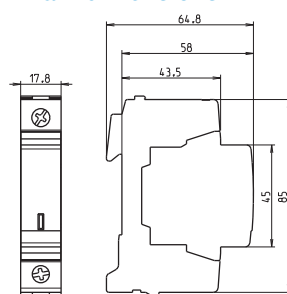

OVR T2 40-275 P
OVR T2 40-275s P
OVR T2 70-275s P
OVR T2 70 N P

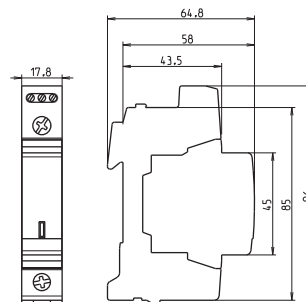





OVR T2 40-275 P TS
OVR T2 40-275s P TS
OVR T2 70-275s P TS

Type	Width	
	mm	inches
OVR T2 40-275 P	17.8	0.70
OVR T2 40-275 P TS	17.8	0.70
OVR T2 40-275s P	17.8	0.70
OVR T2 40-275s P TS	17.8	0.70
OVR T2 70-275s P	17.8	0.70
OVR T2 70-275s P TS	17.8	0.70
OVR T2 70 N P	17.8	0.70

OVR Type 2 surge protective devices

Single pole 230 V networks

General technical data

Types		OVR T2 15-275 P	OVR T2 40-275 P	OVR T2 40-275s P	OVR T2 70-275s P	OVR T2 70 N P
	with auxiliary contact (TS)	-	OVR T2 40-275 P TS	OVR T2 40-275s P TS	OVR T2 70-275s P TS	-
Technology		Varistor	Varistor	Varistor	Varistor	Gas discharge tube (GDT)
Wiring diagram						
Electrical features		IEC 61643-1 / EN 61643-11				
Standard		IEC 61643-1 / EN 61643-11				
Type / test class		T2 / II	T2 / II	T2 / II	T2 / II	T2 / II
Protected lines		1	1	1	1	1
Types of networks		TNC / TNS / TT	TNC / TNS / TT	TNC / TNS / TT	TNC / TNS / TT	Neutral
Type of current		AC	AC	AC	AC	AC
Nominal voltage Un (L-N/L-L)	V	230 / 400	230 / 400	230 / 400	230 / 400	230 / 400
Max. cont. operating voltage Uc	V	275	275	275	275	255
Maximum discharge current Imax (8/20)	kA	15	40	40	70	70
Nominal discharge current In (8/20)	kA	5	20	20	30	30
Voltage protection level Up at In	kA	1.0	1.4	1.4	1.5	1.4
Voltage protection level Up at 3 kA	kA	0.9	0.8	0.8	0.8	0.9
TOV (Temporary overvoltage) withstand Ut (L-N: 5 s / N-PE: 200 ms)	V	334 / -	334 / -	334 / -	334 / -	- / 1200
Response time	ns	≤ 25	≤ 25	≤ 25	≤ 25	≤ 100
Residual current IPE	μA	25	25	50	50	10
Short-circuit withstand capability Iscsr	kA	50	50	50	50	50
Backup protection						
Fuse (gG - gL)	A	≤ 50	≤ 50	≤ 50	≤ 50	-
Circuit breaker (B or C curve)	A	≤ 50	≤ 50	≤ 50	≤ 50	-
Pluggable cartridge		Yes	Yes	Yes	Yes	Yes
Integrated thermal disconnecter		Yes	Yes	Yes	Yes	-
State indicator		Yes	Yes	Yes	Yes	-
Safety reserve		No	No	Yes	Yes	-
Auxiliary contact		No	Yes (TS option)	Yes (TS option)	Yes (TS option)	No
Installation						
Wire range (L, N, PE)						
Solid wire	mm ²	2.5...25	2.5...25	2.5...25	2.5...25	2.5...25
Stranded wire	mm ²	2.5...16	2.5...16	2.5...16	2.5...16	2.5...16
Stripping length (L, N, PE)	mm	12.5	12.5	12.5	12.5	12.5
Tightening torque (L, N, PE)	Nm	2.5	2.5	2.5	2.5	2.5
Auxiliary contact (TS)						
Contact complement		-	1 NO - 1 NC	1 NO - 1 NC	1 NO - 1 NC	-
Minimum load		-	12 V DC - 10 mA	12 V DC - 10 mA	12 V DC - 10 mA	-
Maximum load		-	250 V AC - 1 A	250 V AC - 1 A	250 V AC - 1 A	-
Connection cross-section	mm ²	-	1.5	1.5	1.5	-
Miscellaneous characteristics						
Stocking and operating temperature	°C	-40 to +80	-40 to +80	-40 to +80	-40 to +80	-40 to +80
Degree of protection		IP20	IP20	IP20	IP20	IP20
Fire resistance according to UL 94		V0	V0	V0	V0	V0
Dimensions						
height x width x depth	mm	85 x 17.8 x 64.8	85 x 17.8 x 64.8	85 x 17.8 x 64.8	85 x 17.8 x 64.8	85 x 17.8 x 64.8
	inches	3.35 x 0.70 x 2.55	3.35 x 0.70 x 2.55	3.35 x 0.70 x 2.55	3.35 x 0.70 x 2.55	3.35 x 0.70 x 2.55
with auxiliary contact (TS)						
height x width x depth	mm	-	96 x 17.8 x 64.8	96 x 17.8 x 64.8	96 x 17.8 x 64.8	-
	inches	-	3.78 x 0.70 x 2.55	3.78 x 0.70 x 2.55	3.78 x 0.70 x 2.55	-

OVR Type 2 surge protective devices

Single pole 400 V networks



OVR T2 120-440s P TS

Description

Type 2 surge protective devices are designed to protect electric installations and sensitive equipment against indirect surges with ensuring a low protection level (Up). They are characterized by their capacity to safely discharge current with 8/20 μ s wave form.

Ordering details

Nb of poles	Max. discharge current I_{max} 8/20	Nominal discharge current I_n	Voltage protection level U_p	Nominal voltage U_n	Max. cont. operating voltage U_c	Type	Order code	EAN code	Weight Pkg (1 pce)
	kA	kA	kV	V	V			3660308	kg

Type 2 unpluggable - U_c 440 V

1	20	5	1.3	230/400	440	OVR T2 20-440	2CTB804200R0200	518071	0.12
1	40	20	1.9	230/400	440	OVR T2 40-440	2CTB804201R0200	518088	0.12

Type 2 pluggable - U_c 440 V

1	15	5	1.3	230/400	440	OVR T2 15-440 P	2CTB803851R1100	512772	0.12
1	40	20	1.9	230/400	440	OVR T2 40-440 P	2CTB803851R1200	512789	0.12
1	40	20	1.9	230/400	440	OVR T2 40-440 P TS	2CTB803851R0500	514370	0.12
1	40	20	1.9	230/400	440	OVR T2 40-440s P	2CTB803851R0800	512765	0.12
1	40	20	1.9	230/400	440	OVR T2 40-440s P TS	2CTB803851R0200	512741	0.12
1	70	30	2.0	230/400	440	OVR T2 70-440s P	2CTB803851R0700	512758	0.12
1	70	30	2.0	230/400	440	OVR T2 70-440s P TS	2CTB803851R0100	512734	0.12
1	120	60	2.5	230/400	440	OVR T2 120-440s P TS	2CTB803951R1300	517067	0.25

Main dimensions mm

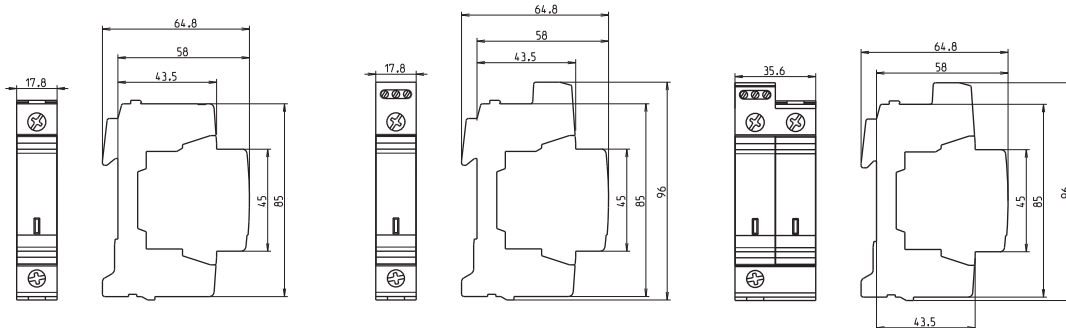

OVR T2 20-440
OVR T2 40-440
OVR T2 15-440 P
OVR T2 40-440 P
OVR T2 40-440s P
OVR T2 70-440s P

OVR T2 40-440 P TS
OVR T2 40-440s P TS
OVR T2 70-440s P TS
OVR T2 120-440s P TS

OVR T2 120-440s P TS

Type	Width	
	mm	inches
OVR T2 20-440	17.8	0.70
OVR T2 40-440	17.8	0.70
OVR T2 15-440 P	17.8	0.70
OVR T2 40-440 P	17.8	0.70
OVR T2 40-440 P TS	17.8	0.70
OVR T2 40-440s P	17.8	0.70
OVR T2 40-440s P TS	17.8	0.70
OVR T2 70-440s P	17.8	0.70
OVR T2 70-440s P TS	17.8	0.70
OVR T2 120-440s P TS	35.6	1.40

OVR Type 2 surge protective devices

Single pole 400 V networks

General technical data

Types		OVR T2 20-440	OVR T2 40-440	OVR T2 15-440 P	OVR T2 40-440(s) P	OVR T2 70-440s P	-
	with auxiliary contact (TS)	-	-	-	OVR T2 40-440(s) P TS	OVR T2 70-440s P TS	OVR T2 120-440s P TS
Technology		Varistor	Varistor	Varistor	Varistor	Varistor	Varistor
Wiring diagram							
Electrical features		IEC 61643-1 / EN 61643-11					
Standard		IEC 61643-1 / EN 61643-11					
Type / test class		T2 / II	T2 / II	T2 / II	T2 / II	T2 / II	T2 / II
Protected lines		1	1	1	1	1	1
Types of networks		TNC / TNS / TT	TNC / TNS / TT	TNC / TNS / TT	TNC / TNS / TT	TNC / TNS / TT	TNC / TNS / TT
Type of current		AC	AC	AC	AC	AC	AC
Nominal voltage Un (L-N/L-L)	V	230 / 400	230 / 400	230 / 400	230 / 400	230 / 400	230 / 400
Max. cont. operating AC voltage Uc	V	440	440	440	440	440	440
Maximum discharge current Imax (8/20)	kA	20	40	15	40	70	120
Nominal discharge current In (8/20)	kA	5	20	5	20	30	60
Voltage protection level Up at In	kA	1.3	1.9	1.3	2.0	2.0	2.5
Voltage protection level Up at 3 kA	kA	1.2	1.3	1.2	1.2	1.2	1.1
TOV (Temporary overvoltage) withstand Ut (L-N: 5 s / N-PE: 200 ms)	V	440 / -	440 / -	440 / -	440 / -	440 / -	440 / -
Response time	ns	≤ 25	≤ 25	≤ 25	≤ 25	≤ 25	≤ 25
Residual current IPE	µA	25	25	25	25 (50 for s option)	50	50
Short-circuit withstand capability Iscsr	kA	50	50	50	50	50	50
Backup protection							
Fuse (gG - gL)	A	≤ 50	≤ 50	≤ 50	≤ 50	≤ 50	≤ 50
Circuit breaker (B or C curve)	A	≤ 50	≤ 50	≤ 50	≤ 50	≤ 50	≤ 50
Pluggable cartridge		No	No	Yes	Yes	Yes	Yes
Integrated thermal disconnecter		Yes	Yes	Yes	Yes	Yes	Yes
State indicator		Yes	Yes	Yes	Yes	Yes	Yes
Safety reserve		No	No	No	Yes (s option)	Yes	Yes
Auxiliary contact		No	No	No	Yes (TS option)	Yes (TS option)	Yes
Installation							
Wire range (L, N, PE)							
Solid wire	mm ²	2.5...25	2.5...25	2.5...25	2.5...25	2.5...25	2.5...25
Stranded wire	mm ²	2.5...16	2.5...16	2.5...16	2.5...16	2.5...16	2.5...16
Stripping length (L, N, PE)	mm	12.2	12.2	12.5	12.5	12.5	12.5
Tightening torque (L, N, PE)	Nm	2.5	2.5	2.5	2.5	2.5	2.5
Auxiliary contact (TS)							
Contact complement		-	-	-	1 NO - 1 NC	1 NO - 1 NC	1 NO - 1 NC
Minimum load		-	-	-	12 V DC - 10 mA	12 V DC - 10 mA	12 V DC - 10 mA
Maximum load		-	-	-	250 V AC - 1 A	250 V AC - 1 A	250 V AC - 1 A
Connection cross-section	mm ²	-	-	-	1.5	1.5	1.5
Miscellaneous characteristics							
Stocking and operating temperature	°C	-40 to +80	-40 to +80	-40 to +80	-40 to +80	-40 to +80	-40 to +80
Degree of protection		IP20	IP20	IP20	IP20	IP20	IP20
Fire resistance according to UL 94		V0	V0	V0	V0	V0	V0
Dimensions							
height x width x depth	mm	85 x 17.8 x 64.8	85 x 17.8 x 64.8	85 x 17.8 x 64.8	85 x 17.8 x 64.8	85 x 17.8 x 64.8	-
	inches	3.35 x 0.70 x 2.55	3.35 x 0.70 x 2.55	3.35 x 0.70 x 2.55	3.35 x 0.70 x 2.55	3.35 x 0.70 x 2.55	-
with auxiliary contact (TS)							
height x width x depth	mm	-	-	-	85 x 17.8 x 64.8	85 x 17.8 x 64.8	96 x 35.6 x 64.8
	inches	-	-	-	3.35 x 0.70 x 2.55	3.35 x 0.70 x 2.55	3.78 x 1.40 x 2.55

OVR Type 2 surge protective devices TNC 230 V networks



OVR T2 3L 20-275

Description

Type 2 surge protective devices are designed to protect electric installations and sensitive equipment against indirect surges with ensuring a low protection level (Up). They are characterized by their capacity to safely discharge current with 8/20 μ s wave form.

Ordering details

Nb of poles	Max. discharge current I_{max} 8/20 kA	Nominal discharge current I_n kA	Voltage protection level U_p kV	Nominal voltage U_n V	Max. cont. operating voltage U_c V	Type	Order code	EAN code	Weight Pkg (1 pce) kg
-------------	---------------------------------------------------	------------------------------------------	-----------------------------------------	-------------------------------	--------------------------------------------	------	------------	----------	--------------------------------

Type 2 unpluggable - U_c 275 V

3	20	5	1.0	230/400	275	OVR T2 3L 20-275	2CTB804600R0400	515957	0.35
3	40	20	1.4	230/400	275	OVR T2 3L 40-275	2CTB804601R0400	515964	0.35

Type 2 pluggable - U_c 275 V

3	15	5	1.0	230/400	275	OVR T2 3L 15-275 P	2CTB803853R3400	512987	0.35
3	40	20	1.4	230/400	275	OVR T2 3L 40-275 P	2CTB803853R2400	513366	0.35
3	40	20	1.4	230/400	275	OVR T2 3L 40-275 P TS	2CTB803853R2500	514400	0.35
3	40	20	1.4	230/400	275	OVR T2 3L 40-275s P	2CTB803853R2200	512963	0.35
3	40	20	1.4	230/400	275	OVR T2 3L 40-275s P TS	2CTB803853R2300	512970	0.35
3	70	30	1.5	230/400	275	OVR T2 3L 70-275s P	2CTB803853R4100	512994	0.35
3	70	30	1.5	230/400	275	OVR T2 3L 70-275s P TS	2CTB803853R4400	513007	0.35

Main dimensions mm

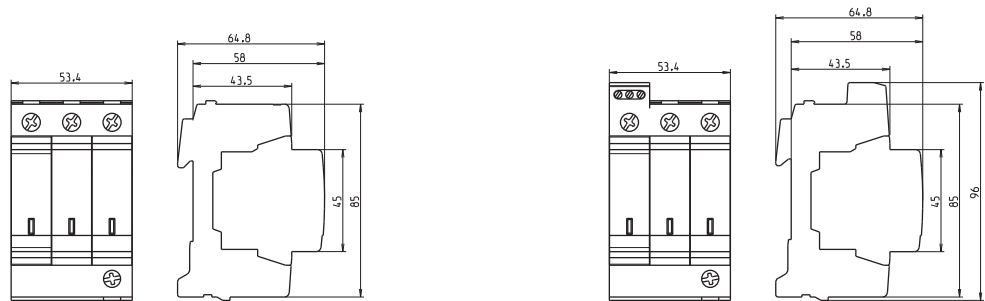

OVR T2 3L 20-275
OVR T2 3L 40-275
OVR T2 3L 15-275 P
OVR T2 3L 40-275 P
OVR T2 3L 40-275s P
OVR T2 3L 70-275s P

OVR T2 3L 40-275 P TS
OVR T2 3L 40-275s P TS
OVR T2 3L 70-275s P TS

Type	Width	
	mm	inches
OVR T2 3L 20-275	53.4	2.10
OVR T2 3L 40-275	53.4	2.10
OVR T2 3L 15-275 P	53.4	2.10
OVR T2 3L 40-275 P	53.4	2.10
OVR T2 3L 40-275 P TS	53.4	2.10
OVR T2 3L 40-275s P	53.4	2.10
OVR T2 3L 40-275s P TS	53.4	2.10
OVR T2 3L 70-275s P	53.4	2.10
OVR T2 3L 70-275s P TS	53.4	2.10

OVR Type 2 surge protective devices TNC 230 V networks

General technical data

Types		OVR T2 3L 20-275	OVR T2 3L 40-275	OVR T2 3L 15-275 P	OVR T2 3L 40-275(s) P OVR T2 3L 40-275(s) P TS	OVR T2 3L 70-275s P OVR T2 3L 70-275s P TS
	with auxiliary contact (TS)	-	-	-		
Technology		Varistor	Varistor	Varistor	Varistor	Varistor
Wiring diagram						
Electrical features		IEC 61643-1 / EN 61643-11				
Standard		IEC 61643-1 / EN 61643-11				
Type / test class		T2 / II	T2 / II	T2 / II	T2 / II	T2 / II
Protected lines		3	3	3	3	3
Types of networks		TNC	TNC	TNC	TNC	TNC
Type of current		AC	AC	AC	AC	AC
Nominal voltage Un (L-N/L-L)	V	230 / 400	230 / 400	230 / 400	230 / 400	230 / 400
Max. cont. operating AC voltage Uc	V	275	275	275	275	275
Maximum discharge current Imax (8/20)	kA	20	40	15	40	70
Nominal discharge current In (8/20)	kA	5	20	5	20	30
Voltage protection level Up at In	kA	1.0	1.4	1.0	1.4	1.5
Voltage protection level Up at 3 kA	kA	0.9	0.9	0.9	0.8	0.8
TOV (Temporary overvoltage) withstand Ut (L-N: 5 s / N-PE: 200 ms)	V	334 / -	334 / -	334 / -	334 / -	334 / -
Response time	ns	≤ 25	≤ 25	≤ 25	≤ 25	≤ 25
Residual current IPE	μA	75	75	75	75 (150 for s option)	150
Short-circuit withstand capability Iscsr	kA	50	50	50	50	50
Backup protection						
Fuse (gG - gL)	A	≤ 50	≤ 50	≤ 50	≤ 50	≤ 50
Circuit breaker (B or C curve)	A	≤ 50	≤ 50	≤ 50	≤ 50	≤ 50
Pluggable cartridge		No	No	Yes	Yes	Yes
Integrated thermal disconnecter		Yes	Yes	Yes	Yes	Yes
State indicator		Yes	Yes	Yes	Yes	Yes
Safety reserve		No	No	No	Yes (s option)	Yes
Auxiliary contact		No	No	No	Yes (TS option)	Yes (TS option)
Installation						
Wire range (L, N, PE)						
Solid wire	mm ²	2.5...25	2.5...25	2.5...25	2.5...25	2.5...25
Stranded wire	mm ²	2.5...16	2.5...16	2.5...16	2.5...16	2.5...16
Stripping length (L, N, PE)	mm	12.5	12.5	12.5	12.5	12.5
Tightening torque (L, N, PE)	Nm	2.5	2.5	2.5	2.5	2.5
Auxiliary contact (TS)						
Contact complement		-	-	-	1 NO - 1 NC	1 NO - 1 NC
Minimum load		-	-	-	12 V DC - 10 mA	12 V DC - 10 mA
Maximum load		-	-	-	250 V AC - 1 A	250 V AC - 1 A
Connection cross-section	mm ²	-	-	-	1.5	1.5
Miscellaneous characteristics						
Stocking and operating temperature	°C	-40 to +80	-40 to +80	-40 to +80	-40 to +80	-40 to +80
Degree of protection		IP20	IP20	IP20	IP20	IP20
Fire resistance according to UL 94		V0	V0	V0	V0	V0
Dimensions						
height x width x depth	mm	85 x 53.4 x 64.8	85 x 53.4 x 64.8	85 x 53.4 x 64.8	85 x 53.4 x 64.8	85 x 53.4 x 64.8
	inches	3.35 x 2.10 x 2.55	3.35 x 2.10 x 2.55	3.35 x 2.10 x 2.55	3.35 x 2.10 x 2.55	3.35 x 2.10 x 2.55
with auxiliary contact (TS)						
height x width x depth	mm	-	-	-	96 x 53.4 x 64.8	96 x 53.4 x 64.8
	inches	-	-	-	3.78 x 2.10 x 2.55	3.78 x 2.10 x 2.55

OVR Type 2 surge protective devices TNC 400 V networks



OVR T2 3L 40-440/690 P

Description

Type 2 surge protective devices are designed to protect electric installations and sensitive equipment against indirect surges with ensuring a low protection level (Up). They are characterized by their capacity to safely discharge current with 8/20 μ s wave form.

Ordering details

Nb of poles	Max. discharge current I_{max} 8/20 kA	Nominal discharge current I_n kA	Voltage protection level U_p kV	Nominal voltage U_n V	Max. cont. operating voltage U_c V	Type	Order code	EAN code	Weight Pkg (1 pce) kg
								3660308	

Type 2 pluggable - U_c 440 V

3	40	20	1.9	230/400	440	OVR T2 3L 40-440 P	2CTB803853R2600	516879	0.45
3	40	20	1.9	230/400	440	OVR T2 3L 40-440 P TS	2CTB803853R2700	516886	0.45
3	70	30	2.0	230/400	440	OVR T2 3L 70-440s P	2CTB803853R4200	516893	0.45
3	70	30	2.0	230/400	440	OVR T2 3L 70-440s P TS	2CTB803853R4300	516909	0.45
3	40	20	3.0	400/690	440	OVR T2 3L 40-440/690 P	2CTB803853R4500	515629	0.48
3	40	20	3.0	400/690	440	OVR T2 3L 40-440/690 P TS	2CTB803853R4600	515636	0.48

Main dimensions mm

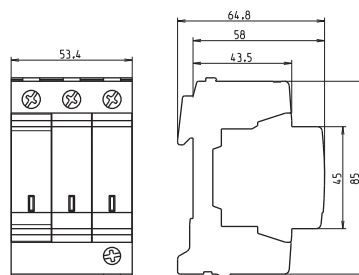

OVR T2 3L 40-440 P
OVR T2 3L 70-440s P
OVR T2 3L 40-440/690 P

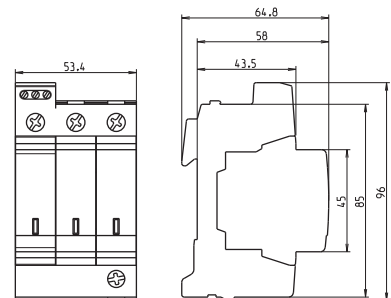



OVR T2 3L 40-440 P TS
OVR T2 3L 70-440s P TS
OVR T2 3L 40-440/690 P TS

Type	Width	
	mm	inches
OVR T2 3L 40-440 P	53.4	2.10
OVR T2 3L 40-440 P TS	53.4	2.10
OVR T2 3L 70-440s P	53.4	2.10
OVR T2 3L 70-440s P TS	53.4	2.10
OVR T2 3L 40-440/690 P	53.4	2.10
OVR T2 3L 40-440/690 P TS	53.4	2.10

OVR Type 2 surge protective devices TNC 400 V networks

General technical data

Types		OVR T2 3L 40-440 P OVR T2 3L 40-440 P TS	OVR T2 3L 70-440s P OVR T2 3L 70-440s P TS	OVR T2 3L 40-440/690 P OVR T2 3L 40-440/690 P TS
Technology		Varistor	Varistor	Varistor
Wiring diagram	with auxiliary contact (TS)			
Electrical features				
Standard		IEC 61643-1 / EN 61643-11		
Type / test class		T2 / II	T2 / II	T2 / II
Protected lines		3	3	3
Types of networks		TNC	TNC	TNC
Type of current		AC	AC	AC
Nominal voltage Un (L-N/L-L)	V	230 / 400	230 / 400	400 / 690
Max. cont. operating AC voltage Uc	V	440	440	440
Maximum discharge current Imax (8/20)	kA	40	70	40
Nominal discharge current In (8/20)	kA	20	30	20
Voltage protection level Up at In	kA	1.9	2.0	3.0
Voltage protection level Up at 3 kA	kA	1.3	1.2	2.1
TOV (Temporary overvoltage) withstand Ut (L-N: 5 s / N-PE: 200 ms)	V	440 / -	440 / -	440 / -
Response time	ns	≤ 25	≤ 25	≤ 25
Residual current IPE	µA	75 (150 for s option)	150	75
Short-circuit withstand capability Iscsr	kA	50	50	50
Backup protection				
Fuse (gG - gL)	A	≤ 50	≤ 50	≤ 50
Circuit breaker (B or C curve)	A	≤ 50	≤ 50	≤ 50
Pluggable cartridge		Yes	Yes	Yes
Integrated thermal disconnecter		Yes	Yes	Yes
State indicator		Yes	Yes	Yes
Safety reserve		No	Yes	No
Auxiliary contact		Yes (TS option)	Yes (TS option)	No
Installation				
Wire range (L, N, PE)				
Solid wire	mm ²	2.5...25	2.5...25	2.5...25
Stranded wire	mm ²	2.5...16	2.5...16	2.5...16
Stripping length (L, N, PE)	mm	12.5	12.5	12.5
Tightening torque (L, N, PE)	Nm	2.5	2.5	2.5
Auxiliary contact (TS)				
Contact complement		1 NO - 1 NC	1 NO - 1 NC	1 NO - 1 NC
Minimum load		12 V DC - 10 mA	12 V DC - 10 mA	12 V DC - 10 mA
Maximum load		250 V AC - 1 A	250 V AC - 1 A	250 V AC - 1 A
Connection cross-section	mm ²	1.5	1.5	1.5
Miscellaneous characteristics				
Stocking and operating temperature	°C	-40 to +80	-40 to +80	-40 to +80
Degree of protection		IP20	IP20	IP20
Fire resistance according to UL 94		V0	V0	V0
Dimensions				
height x width x depth	mm	85 x 53.4 x 64.8	85 x 53.4 x 64.8	85 x 53.4 x 64.8
	inches	3.35 x 2.10 x 2.55	3.35 x 2.10 x 2.55	3.35 x 2.10 x 2.55
with auxiliary contact (TS)				
height x width x depth	mm	96 x 53.4 x 64.8	96 x 53.4 x 64.8	96 x 53.4 x 64.8
	inches	3.78 x 2.10 x 2.55	3.78 x 2.10 x 2.55	3.78 x 2.10 x 2.55

OVR Type 2 surge protective devices TNS 230 V networks



OVR T2 4L 20-275

Description

Type 2 surge protective devices are designed to protect electric installations and sensitive equipment against indirect surges with ensuring a low protection level (Up). They are characterized by their capacity to safely discharge current with 8/20 μ s wave form.

Ordering details

Nb of poles	Max. discharge current I_{max} 8/20 kA	Nominal discharge current I_n kA	Voltage protection level U_p kV	Nominal voltage U_n V	Max. cont. operating voltage U_c V	Type	Order code	EAN code	Weight Pkg (1 pce) kg
-------------	---------------------------------------------------	------------------------------------------	-----------------------------------------	-------------------------------	--------------------------------------------	------	------------	----------	--------------------------------

Type 2 unpluggable - U_c 275 V

4	20	5	1.0	230/400	275	OVR T2 4L 20-275	2CTB804600R0500	515971	0.45
4	40	20	1.4	230/400	275	OVR T2 4L 40-275	2CTB804601R0500	515988	0.45

Type 2 pluggable - U_c 275 V

4	15	5	1.0	230/400	275	OVR T2 4L 15-275 P	2CTB803853R6000	513038	0.45
4	40	20	1.4	230/400	275	OVR T2 4L 40-275 P	2CTB803853R5600	513274	0.45
4	40	20	1.4	230/400	275	OVR T2 4L 40-275 P TS	2CTB803853R5200	514417	0.45
4	40	20	1.4	230/400	275	OVR T2 4L 40-275s P	2CTB803853R5400	513021	0.45
4	40	20	1.4	230/400	275	OVR T2 4L 40-275s P TS	2CTB803853R5000	513014	0.45
4	70	30	1.5	230/400	275	OVR T2 4L 70-275s P	2CTB803919R0200	513045	0.45
4	70	30	1.5	230/400	275	OVR T2 4L 70-275s P TS	2CTB803919R0400	513052	0.45

Main dimensions mm

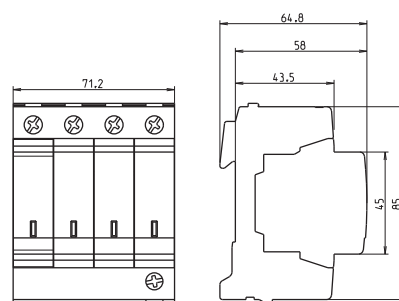

OVR T2 4L 20-275
OVR T2 4L 40-275
OVR T2 4L 15-275 P
OVR T2 4L 40-275 P
OVR T2 4L 40-275s P
OVR T2 4L 70-275s P

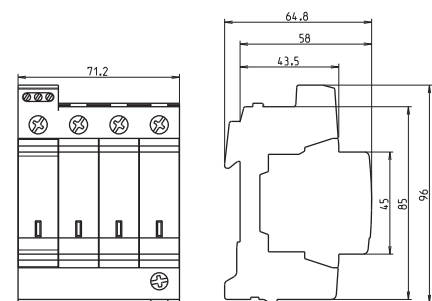





OVR T2 4L 40-275 P TS
OVR T2 4L 40-275s P TS
OVR T2 4L 70-275s P TS

Type	Width	
	mm	inches
OVR T2 4L 20-275	71.2	2.80
OVR T2 4L 40-275	71.2	2.80
OVR T2 4L 15-275 P	71.2	2.80
OVR T2 4L 40-275 P	71.2	2.80
OVR T2 4L 40-275 P TS	71.2	2.80
OVR T2 4L 40-275s P	71.2	2.80
OVR T2 4L 40-275s P TS	71.2	2.80
OVR T2 4L 70-275s P	71.2	2.80
OVR T2 4L 70-275s P TS	71.2	2.80

OVR Type 2 surge protective devices TNS 230 V networks

General technical data

Types		OVR T2 4L 20-275	OVR T2 4L 40-275	OVR T2 4L 15-275 P	OVR T2 4L 40-275(s) P	OVR T2 4L 70-275s P
	with auxiliary contact (TS)	-	-	-	OVR T2 4L 40-275(s) P TS	OVR T2 4L 70-275s P TS
Technology		Varistor	Varistor	Varistor	Varistor	Varistor
Wiring diagram						
Electrical features		IEC 61643-1 / EN 61643-11				
Standard		IEC 61643-1 / EN 61643-11				
Type / test class		T2 / II	T2 / II	T2 / II	T2 / II	T2 / II
Protected lines		4	4	4	4	4
Types of networks		TNS	TNS	TNS	TNS	TNS
Type of current		AC	AC	AC	AC	AC
Nominal voltage Un (L-N/L-L)	V	230 / 400	230 / 400	230 / 400	230 / 400	230 / 400
Max. cont. operating AC voltage Uc	V	275	275	275	275	275
Maximum discharge current Imax (8/20)	kA	20	40	15	40	70
Nominal discharge current In (8/20)	kA	5	20	5	20	30
Voltage protection level Up at In	kA	1.0	1.4	1.0	1.4	1.5
Voltage protection level Up at 3 kA	kA	0.9	0.9	0.9	0.8	0.8
TOV (Temporary overvoltage) withstand Ut (L-N: 5 s / N-PE: 200 ms)	V	334 / -	334 / -	334 / -	334 / -	334 / -
Response time	ns	≤ 25	≤ 25	≤ 25	≤ 25	≤ 25
Residual current IPE	μA	100	100	100	100 (200 for s option)	200
Short-circuit withstand capability Iscsr	kA	50	50	50	50	50
Backup protection						
Fuse (gG - gL)	A	≤ 50	≤ 50	≤ 50	≤ 50	≤ 50
Circuit breaker (B or C curve)	A	≤ 50	≤ 50	≤ 50	≤ 50	≤ 50
Pluggable cartridge		No	No	Yes	Yes	Yes
Integrated thermal disconnecter		Yes	Yes	Yes	Yes	Yes
State indicator		Yes	Yes	Yes	Yes	Yes
Safety reserve		No	No	No	Yes (s option)	Yes
Auxiliary contact		No	No	No	Yes (TS option)	Yes (TS option)
Installation						
Wire range (L, N, PE)						
Solid wire	mm ²	2.5...25	2.5...25	2.5...25	2.5...25	2.5...25
Stranded wire	mm ²	2.5...16	2.5...16	2.5...16	2.5...16	2.5...16
Stripping length (L, N, PE)	mm	12.5	12.5	12.5	12.5	12.5
Tightening torque (L, N, PE)	Nm	2.5	2.5	2.5	2.5	2.5
Auxiliary contact (TS)						
Contact complement		-	-	-	1 NO - 1 NC	1 NO - 1 NC
Minimum load		-	-	-	12 V DC - 10 mA	12 V DC - 10 mA
Maximum load		-	-	-	250 V AC - 1 A	250 V AC - 1 A
Connection cross-section	mm ²	-	-	-	1.5	1.5
Miscellaneous characteristics						
Stocking and operating temperature	°C	-40 to +80	-40 to +80	-40 to +80	-40 to +80	-40 to +80
Degree of protection		IP20	IP20	IP20	IP20	IP20
Fire resistance according to UL 94		V0	V0	V0	V0	V0
Dimensions						
height x width x depth	mm	85 x 71.2 x 64.8	85 x 71.2 x 64.8	85 x 71.2 x 64.8	85 x 71.2 x 64.8	85 x 71.2 x 64.8
	inches	3.35 x 2.80 x 2.55	3.35 x 2.80 x 2.55	3.35 x 2.80 x 2.55	3.35 x 2.80 x 2.55	3.35 x 2.80 x 2.55
with auxiliary contact (TS)						
height x width x depth	mm	-	-	-	96 x 71.2 x 64.8	96 x 71.2 x 64.8
	inches	-	-	-	3.78 x 2.80 x 2.55	3.78 x 2.80 x 2.55

OVR Type 2 surge protective devices TNS 400 V networks



OVR T2 4L 40-440 P

Description

Type 2 surge protective devices are designed to protect electric installations and sensitive equipment against indirect surges with ensuring a low protection level (U_p). They are characterized by their capacity to safely discharge current with 8/20 μ s wave form.

Ordering details

Nb of poles	Max. discharge current I_{max} 8/20 kA	Nominal discharge current I_n kA	Voltage protection level U_p kV	Nominal voltage U_n V	Max. cont. operating voltage U_c V	Type	Order code	EAN code	Weight Pkg (1 pce) kg
								3660308	

Type 2 pluggable - U_c 440 V

4	40	20	1.9	230/400	440	OVR T2 4L 40-440 P	2CTB803853R5100	516916	0.48
4	40	20	1.9	230/400	440	OVR T2 4L 40-440 P TS	2CTB803853R5300	516923	0.48
4	70	30	2.0	230/400	440	OVR T2 4L 70-440s P	2CTB803853R7000	516930	0.48
4	70	30	2.0	230/400	440	OVR T2 4L 70-440s P TS	2CTB803853R7100	516947	0.48

Main dimensions mm

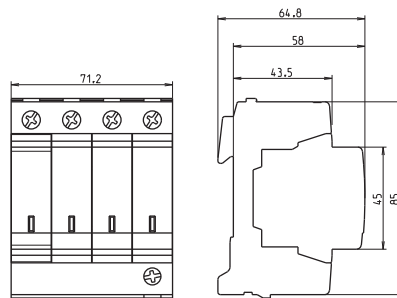

OVR T2 4L 40-440 P
OVR T2 4L 70-440s P

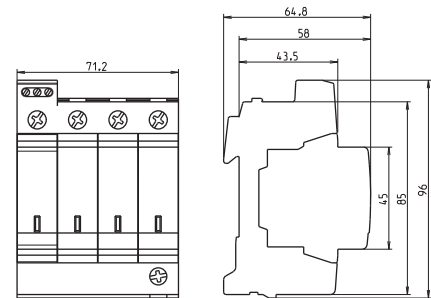



OVR T2 4L 40-440 P TS
OVR T2 4L 70-440s P TS

Type	Width	
	mm	inches
OVR T2 4L 40-440 P	71.2	2.80
OVR T2 4L 40-440 P TS	71.2	2.80
OVR T2 4L 70-440s P	71.2	2.80
OVR T2 4L 70-440s P TS	71.2	2.80

OVR Type 2 surge protective devices TNS 400 V networks

General technical data

Types		OVR T2 4L 40-440 P OVR T2 4L 40-440 P TS	OVR T2 4L 70-440s P OVR T2 4L 70-440s P TS
Technology		Varistor	Varistor
Wiring diagram			
Electrical features			
Standard		IEC 61643-1 / EN 61643-11	
Type / test class		T2 / II	T2 / II
Protected lines		4	4
Types of networks		TNS	TNS
Type of current		AC	AC
Nominal voltage Un (L-N/L-L)	V	230 / 400	230 / 400
Max. cont. operating AC voltage Uc	V	440	440
Maximum discharge current Imax (8/20)	kA	40	70
Nominal discharge current In (8/20)	kA	20	30
Voltage protection level Up at In	kA	1.9	2.0
Voltage protection level Up at 3 kA	kA	1.5	1.2
TOV (Temporary overvoltage) withstand Ut (L-N: 5 s / N-PE: 200 ms)	V	440 / -	440 / -
Response time	ns	≤ 25	≤ 25
Residual current IPE	µA	100	200
Short-circuit withstand capability Iscrc	kA	50	50
Backup protection			
Fuse (gG - gL)	A	≤ 50	≤ 50
Circuit breaker (B or C curve)	A	≤ 50	≤ 50
Pluggable cartridge		Yes	Yes
Integrated thermal disconnecter		Yes	Yes
State indicator		Yes	Yes
Safety reserve		No	Yes
Auxiliary contact		Yes (TS option)	Yes (TS option)
Installation			
Wire range (L, N, PE)			
Solid wire	mm ²	2.5...25	2.5...25
Stranded wire	mm ²	2.5...16	2.5...16
Stripping length (L, N, PE)	mm	12.5	12.5
Tightening torque (L, N, PE)	Nm	2.5	2.5
Auxiliary contact (TS)			
Contact complement		1 NO - 1 NC	1 NO - 1 NC
Minimum load		12 V DC - 10 mA	12 V DC - 10 mA
Maximum load		250 V AC - 1 A	250 V AC - 1 A
Connection cross-section	mm ²	1.5	1.5
Miscellaneous characteristics			
Stocking and operating temperature	°C	-40 to +80	-40 to +80
Degree of protection		IP20	IP20
Fire resistance according to UL 94		V0	V0
Dimensions			
height x width x depth	mm	85 x 71.2 x 64.8	85 x 71.2 x 64.8
	inches	3.35 x 2.80 x 2.55	3.35 x 2.80 x 2.55
with auxiliary contact (TS)			
height x width x depth	mm	96 x 71.2 x 64.8	96 x 71.2 x 64.8
	inches	3.78 x 2.80 x 2.55	3.78 x 2.80 x 2.55

OVR Type 2 surge protective devices TNS/TT 230 V 1Ph+N networks



OVR T2 1N 15-275 P

Description

Type 2 surge protective devices are designed to protect electric installations and sensitive equipment against indirect surges with ensuring a low protection level (Up). They are characterized by their capacity to safely discharge current with 8/20 μ s wave form.

Ordering details

Nb of poles	Max. discharge current Imax 8/20 kA	Nominal discharge current In kA	Voltage protection level Up kV	Nominal voltage Un V	Max. cont. operating voltage Uc V	Type	Order code	EAN code	Weight Pkg (1 pce) kg
								3660308	

Type 2 pluggable - Uc 275 V

1+1	15	5	1.0	230/400	275	OVR T2 1N 15-275 P	2CTB803952R1200	513106	0.25
1+1	40	20	1.4	230/400	275	OVR T2 1N 40-275 P	2CTB803952R1100	513250	0.25
1+1	40	20	1.4	230/400	275	OVR T2 1N 40-275 P TS	2CTB803952R0500	514387	0.25
1+1	40	20	1.4	230/400	275	OVR T2 1N 40-275s P	2CTB803952R0800	513090	0.25
1+1	40	20	1.4	230/400	275	OVR T2 1N 40-275s P TS	2CTB803952R0200	513076	0.25
1+1	70	30	1.5	230/400	275	OVR T2 1N 70-275s P	2CTB803952R0700	513083	0.25
1+1	70	30	1.5	230/400	275	OVR T2 1N 70-275s P TS	2CTB803952R0100	513069	0.25

Main dimensions mm

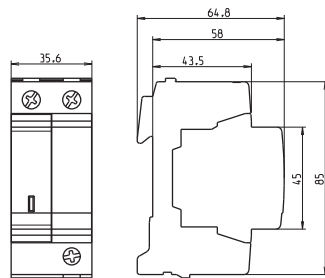

OVR T2 1N 15-275 P
OVR T2 1N 40-275 P
OVR T2 1N 40-275s P
OVR T2 1N 70-275s P

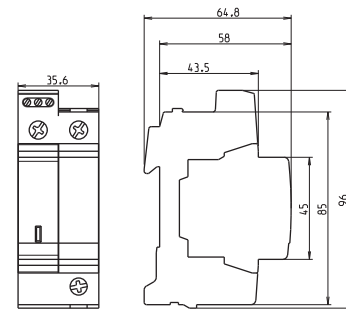



OVR T2 1N 40-275 P TS
OVR T2 1N 40-275s P TS
OVR T2 1N 70-275s P TS

Type	Width	
	mm	inches
OVR T2 1N 15-275 P	35.6	1.40
OVR T2 1N 40-275 P	35.6	1.40
OVR T2 1N 40-275 P TS	35.6	1.40
OVR T2 1N 40-275s P	35.6	1.40
OVR T2 1N 40-275s P TS	35.6	1.40
OVR T2 1N 70-275s P	35.6	1.40
OVR T2 1N 70-275s P TS	35.6	1.40

OVR Type 2 surge protective devices

TNS/TT 230 V 1Ph+N networks

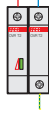
General technical data

Types		OVR T2 1N 15-275 P	OVR T2 1N 40-275 P	OVR T2 1N 40-275s P	OVR T2 1N 70-275s P
	with auxiliary contact (TS)	-	OVR T2 1N 40-275 P TS	OVR T2 1N 40-275s P TS	OVR T2 1N 70-275s P TS
Technology		Varistor	Varistor	Varistor	Varistor
Wiring diagram					
Electrical features		IEC 61643-1 / EN 61643-11			
Standard		IEC 61643-1 / EN 61643-11			
Type / test class		T2 / II	T2 / II	T2 / II	T2 / II
Protected lines		1+1	1+1	1+1	1+1
Types of networks		TNS / TT	TNS / TT	TNS / TT	TNS / TT
Type of current		AC	AC	AC	AC
Nominal voltage Un (L-N/L-L)	V	230 / 400	230 / 400	230 / 400	230 / 400
Max. cont. operating AC voltage Uc	V	275	275	275	275
Maximum discharge current Imax (8/20)	kA	15	40	40	70
Nominal discharge current In (8/20)	kA	5	20	20	30
Voltage protection level Up at In (L-N/N-PE/L-PE)	kA	1.0 / 1.0 / 1.0	1.4 / 1.4 / 1.5	1.4 / 1.4 / 1.5	1.5 / 1.5 / 1.7
Voltage protection level Up at 3 kA (L-N/N-PE/L-PE)	kA	0.9 / 0.9 / 0.9	0.9 / 0.9 / 0.9	0.9 / 0.9 / 0.9	0.8 / 0.8 / 0.8
TOV (Temporary overvoltage) withstand Ut (L-N: 5 s / N-PE: 200 ms)	V	334 / 1200	334 / 1200	334 / 1200	334 / 1200
Response time	ns	≤ 25	≤ 25	≤ 25	≤ 25
Residual current IPE	µA	10	10	10	10
Short-circuit withstand capability Iscc	kA	50	50	50	50
Backup protection					
Fuse (gG - gL)	A	≤ 50	≤ 50	≤ 50	≤ 50
Circuit breaker (B or C curve)	A	≤ 50	≤ 50	≤ 50	≤ 50
Pluggable cartridge		Yes	Yes	Yes	Yes
Integrated thermal disconnecter		Yes	Yes	Yes	Yes
State indicator		Yes	Yes	Yes	Yes
Safety reserve		No	No	Yes	Yes
Auxiliary contact		No	Yes (TS option)	Yes (TS option)	Yes (TS option)
Installation					
Wire range (L, N, PE)					
Solid wire	mm ²	2.5...25	2.5...25	2.5...25	2.5...25
Stranded wire	mm ²	2.5...16	2.5...16	2.5...16	2.5...16
Stripping length (L, N, PE)	mm	12.5	12.5	12.5	12.5
Tightening torque (L, N, PE)	Nm	2.5	2.5	2.5	2.5
Auxiliary contact (TS)					
Contact complement		-	1 NO - 1 NC	1 NO - 1 NC	1 NO - 1 NC
Minimum load		-	12 V DC - 10 mA	12 V DC - 10 mA	12 V DC - 10 mA
Maximum load		-	250 V AC - 1 A	250 V AC - 1 A	250 V AC - 1 A
Connection cross-section	mm ²	-	1.5	1.5	1.5
Miscellaneous characteristics					
Stocking and operating temperature	°C	-40 to +80	-40 to +80	-40 to +80	-40 to +80
Degree of protection		IP20	IP20	IP20	IP20
Fire resistance according to UL 94		V0	V0	V0	V0
Dimensions					
height x width x depth	mm	85 x 35.6 x 64.8	85 x 35.6 x 64.8	85 x 35.6 x 64.8	85 x 35.6 x 64.8
	inches	3.35 x 1.40 x 2.55	3.35 x 1.40 x 2.55	3.35 x 1.40 x 2.55	3.35 x 1.40 x 2.55
with auxiliary contact (TS)					
height x width x depth	mm	-	96 x 35.6 x 64.8	96 x 35.6 x 64.8	96 x 35.6 x 64.8
	inches	-	3.78 x 1.40 x 2.55	3.78 x 1.40 x 2.55	3.78 x 1.40 x 2.55

OVR Type 2 surge protective devices TNS/TT 230 V 3Ph+N networks



OVR T2 3N 15-275 P

Description

Type 2 surge protective devices are designed to protect electric installations and sensitive equipment against indirect surges with ensuring a low protection level (Up). They are characterized by their capacity to safely discharge current with 8/20 μ s wave form.

Ordering details

Nb of poles	Max. discharge current I_{max} 8/20 kA	Nominal discharge current I_n kA	Voltage protection level U_p kV	Nominal voltage U_n V	Max. cont. operating voltage U_c V	Type	Order code	EAN code	Weight Pkg (1 pce) kg
								3660308	

Type 2 pluggable - U_c 275 V

3+1	15	5	1.0	230/400	275	OVR T2 3N 15-275 P	2CTB803953R1200	513151	0.45
3+1	40	20	1.4	230/400	275	OVR T2 3N 40-275 P	2CTB803953R1100	513267	0.45
3+1	40	20	1.4	230/400	275	OVR T2 3N 40-275 P TS	2CTB803953R0500	514394	0.45
3+1	40	20	1.4	230/400	275	OVR T2 3N 40-275s P	2CTB803953R0800	513144	0.45
3+1	40	20	1.4	230/400	275	OVR T2 3N 40-275s P TS	2CTB803953R0200	513120	0.45
3+1	70	30	1.5	230/400	275	OVR T2 3N 70-275s P	2CTB803953R0700	513137	0.45
3+1	70	30	1.5	230/400	275	OVR T2 3N 70-275s P TS	2CTB803953R0100	513113	0.45

Main dimensions mm

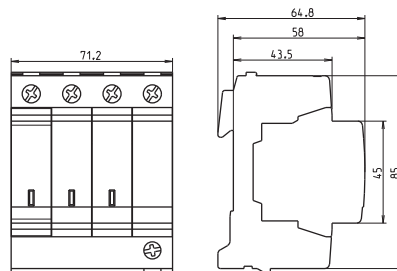

OVR T2 3N 15-275 P
OVR T2 3N 40-275 P
OVR T2 3N 40-275s P
OVR T2 3N 70-275s P

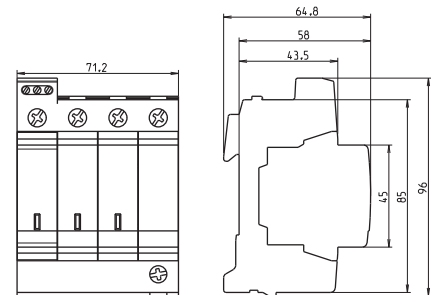



OVR T2 3N 40-275 P TS
OVR T2 3N 40-275s P TS
OVR T2 3N 70-275s P TS

Type	Width	
	mm	inches
OVR T2 3N 15-275 P	71.2	2.80
OVR T2 3N 40-275 P	71.2	2.80
OVR T2 3N 40-275 P TS	71.2	2.80
OVR T2 3N 40-275s P	71.2	2.80
OVR T2 3N 40-275s P TS	71.2	2.80
OVR T2 3N 70-275s P	71.2	2.80
OVR T2 3N 70-275s P TS	71.2	2.80

OVR Type 2 surge protective devices

TNS/TT 230 V 3Ph+N networks

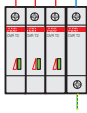
General technical data

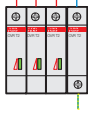
Types		OVR T2 3N 15-275 P	OVR T2 3N 40-275 P	OVR T2 3N 40-275s P	OVR T2 3N 70-275s P
	with auxiliary contact (TS)	-	OVR T2 3N 40-275 P TS	OVR T2 3N 40-275s P TS	OVR T2 3N 70-275s P TS
Technology		Varistor	Varistor	Varistor	Varistor
Wiring diagram					
Electrical features					
Standard		IEC 61643-1 / EN 61643-11			
Type / test class		T2 / II	T2 / II	T2 / II	T2 / II
Protected lines		3+1	3+1	3+1	3+1
Types of networks		TNS / TT	TNS / TT	TNS / TT	TNS / TT
Type of current		AC	AC	AC	AC
Nominal voltage Un (L-N/L-L)	V	230 / 400	230 / 400	230 / 400	230 / 400
Max. cont. operating AC voltage Uc	V	275	275	275	275
Maximum discharge current Imax (8/20)	kA	15	40	40	70
Nominal discharge current In (8/20)	kA	5	20	20	30
Voltage protection level Up at In (L-N/N-PE/L-PE)	kA	1.0 / 1.0 / 1.0	1.4 / 1.4 / 1.5	1.4 / 1.4 / 1.5	1.5 / 1.4 / 1.7
Voltage protection level Up at 3 kA (L-N/N-PE/L-PE)	kA	0.9 / 0.9 / 0.9	0.9 / 0.9 / 0.9	0.9 / 0.9 / 0.9	0.8 / 0.9 / 0.8
TOV (Temporary overvoltage) withstand Ut (L-N: 5 s / N-PE: 200 ms)	V	334 / 1200	334 / 1200	334 / 1200	334 / 1200
Response time	ns	≤ 25	≤ 25	≤ 25	≤ 25
Residual current IPE	µA	10	10	10	10
Short-circuit withstand capability Iscrc	kA	50	50	50	50
Backup protection					
Fuse (gG - gL)	A	≤ 50	≤ 50	≤ 50	≤ 50
Circuit breaker (B or C curve)	A	≤ 50	≤ 50	≤ 50	≤ 50
Pluggable cartridge		Yes	Yes	Yes	Yes
Integrated thermal disconnecter		Yes	Yes	Yes	Yes
State indicator		Yes	Yes	Yes	Yes
Safety reserve		No	No	Yes	Yes
Auxiliary contact		No	Yes (TS option)	Yes (TS option)	Yes (TS option)
Installation					
Wire range (L, N, PE)					
Solid wire	mm ²	2.5...25	2.5...25	2.5...25	2.5...25
Stranded wire	mm ²	2.5...16	2.5...16	2.5...16	2.5...16
Stripping length (L, N, PE)	mm	12.5	12.5	12.5	12.5
Tightening torque (L, N, PE)	Nm	2.5	2.5	2.5	2.5
Auxiliary contact (TS)					
Contact complement		-	1 NO - 1 NC	1 NO - 1 NC	1 NO - 1 NC
Minimum load		-	12 V DC - 10 mA	12 V DC - 10 mA	12 V DC - 10 mA
Maximum load		-	250 V AC - 1 A	250 V AC - 1 A	250 V AC - 1 A
Connection cross-section	mm ²	-	1.5	1.5	1.5
Miscellaneous characteristics					
Stocking and operating temperature	°C	-40 to +80	-40 to +80	-40 to +80	-40 to +80
Degree of protection		IP20	IP20	IP20	IP20
Fire resistance according to UL 94		V0	V0	V0	V0
Dimensions					
height x width x depth	mm	85 x 71.2 x 64.8	85 x 71.2 x 64.8	85 x 71.2 x 64.8	85 x 71.2 x 64.8
	inches	3.35 x 2.80 x 2.55	3.35 x 2.80 x 2.55	3.35 x 2.80 x 2.55	3.35 x 2.80 x 2.55
with auxiliary contact (TS)					
height x width x depth	mm	-	96 x 71.2 x 64.8	96 x 71.2 x 64.8	96 x 71.2 x 64.8
	inches	-	3.35 x 2.80 x 2.55	3.35 x 2.80 x 2.55	3.35 x 2.80 x 2.55

OVR Type 2 surge protective devices TNS/TT 400V 3Ph+N networks



OVR T2 3N 15-440 P

Description

Type 2 surge protective devices are designed to protect electric installations and sensitive equipment against indirect surges with ensuring a low protection level (Up). They are characterized by their capacity to safely discharge current with 8/20 μ s wave form.

Ordering details

Nb of poles	Max. discharge current I_{max} 8/20 kA	Nominal discharge current I_n kA	Voltage protection level U_p kV	Nominal voltage U_n V	Max. cont. operating voltage U_c V	Type	Order code	EAN code	Weight Pkg (1 pce) kg
								3660308	

Type 2 pluggable - U_c 440 V

3+1	15	5	1.3	230/400	440	OVR T2 3N 15-440 P	2CTB803953R1300	516800	0.48
3+1	40	20	1.9	230/400	440	OVR T2 3N 40-440 P	2CTB803953R1400	516817	0.48
3+1	40	20	1.9	230/400	440	OVR T2 3N 40-440 P TS	2CTB803953R1500	516824	0.48
3+1	40	20	1.9	230/400	440	OVR T2 3N 40-440s P TS	2CTB803953R1600	516831	0.48
3+1	70	30	2.0	230/400	440	OVR T2 3N 70-440s P	2CTB803953R1700	516848	0.48
3+1	70	30	2.0	230/400	440	OVR T2 3N 70-440s P TS	2CTB803953R1800	516855	0.48

Main dimensions mm

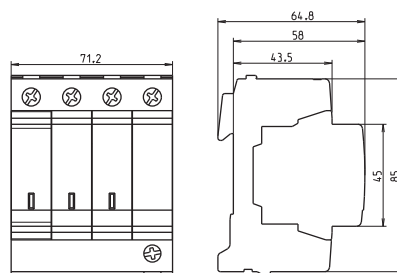

OVR T2 3N 15-440 P
OVR T2 3N 40-440 P
OVR T2 3N 70-440s P

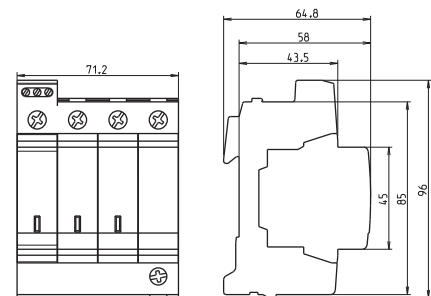





OVR T2 3N 40-440 P TS
OVR T2 3N 40-440s P TS
OVR T2 3N 70-440s P TS

Type	Width	
	mm	inches
OVR T2 3N 15-440 P	71.2	2.80
OVR T2 3N 40-440 P	71.2	2.80
OVR T2 3N 40-440 P TS	71.2	2.80
OVR T2 3N 40-440s P TS	71.2	2.80
OVR T2 3N 70-440s P	71.2	2.80
OVR T2 3N 70-440s P TS	71.2	2.80

OVR Type 2 surge protective devices

TNS/TT 400V 3Ph+N networks

General technical data

Types		OVR T2 3N 15-440 P	OVR T2 3N 40-440 P	-	OVR T2 3N 70-440s P
	with auxiliary contact (TS)	-	OVR T2 3N 40-440 P TS	OVR T2 3N 40-440s P TS	OVR T2 3N 70-440s P TS
Technology		Varistor	Varistor	Varistor	Varistor
Wiring diagram					
Electrical features					
Standard		IEC 61643-1 / EN 61643-11			
Type / test class		T2 / II	T2 / II	T2 / II	T2 / II
Protected lines		3+1	3+1	3+1	3+1
Types of networks		TNS / TT	TNS / TT	TNS / TT	TNS / TT
Type of current		AC	AC	AC	AC
Nominal voltage Un (L-N/L-L)	V	230 / 400	230 / 400	230 / 400	230 / 400
Max. cont. operating AC voltage Uc	V	440	440	440	440
Maximum discharge current Imax (8/20)	kA	15	40	40	70
Nominal discharge current In (8/20)	kA	5	20	20	30
Voltage protection level Up at In (L-N/N-PE/L-PE)	kA	1.5 / 1.3 / 1.5	1.9 / 1.4 / 1.9	1.9 / 1.4 / 1.9	2.0 / 1.4 / 2.3
Voltage protection level Up at 3 kA (L-N/N-PE/L-PE)	kA	1.3 / 1.2 / 1.3	1.3 / 1.2 / 1.3	1.3 / 1.2 / 1.3	1.3 / 1.2 / 1.3
TOV (Temporary overvoltage) withstand Ut (L-N: 5 s / N-PE: 200 ms)	V	440 / -	440 / -	440 / -	440 / -
Response time	ns	≤ 25	≤ 25	≤ 25	≤ 25
Residual current IPE	µA	10	10	10	10
Short-circuit withstand capability Isccr	kA	50	50	50	50
Backup protection					
Fuse (gG - gL)	A	≤ 50	≤ 50	≤ 50	≤ 50
Circuit breaker (B or C curve)	A	≤ 50	≤ 50	≤ 50	≤ 50
Pluggable cartridge		Yes	Yes	Yes	Yes
Integrated thermal disconnecter		Yes	Yes	Yes	Yes
State indicator		Yes	Yes	Yes	Yes
Safety reserve		No	No	Yes	Yes
Auxiliary contact		No	Yes (TS option)	Yes (TS option)	Yes (TS option)
Installation					
Wire range (L, N, PE)					
Solid wire	mm ²	2.5...25	2.5...25	2.5...25	2.5...25
Stranded wire	mm ²	2.5...16	2.5...16	2.5...16	2.5...16
Stripping length (L, N, PE)	mm	12.5	12.5	12.5	12.5
Tightening torque (L, N, PE)	Nm	2.5	2.5	2.5	2.5
Auxiliary contact (TS)					
Contact complement		-	1 NO - 1 NC	1 NO - 1 NC	1 NO - 1 NC
Minimum load		-	12 V DC - 10 mA	12 V DC - 10 mA	12 V DC - 10 mA
Maximum load		-	250 V AC - 1 A	250 V AC - 1 A	250 V AC - 1 A
Connection cross-section	mm ²	-	1.5	1.5	1.5
Miscellaneous characteristics					
Stocking and operating temperature	°C	-40 to +80	-40 to +80	-40 to +80	-40 to +80
Degree of protection		IP20	IP20	IP20	IP20
Fire resistance according to UL 94		V0	V0	V0	V0
Dimensions					
height x width x depth	mm	85 x 71.2 x 64.8	85 x 71.2 x 64.8	-	85 x 71.2 x 64.8
	inches	3.35 x 2.80 x 2.55	3.35 x 2.80 x 2.55	-	3.35 x 2.80 x 2.55
with auxiliary contact (TS)					
height x width x depth	mm	-	96 x 71.2 x 64.8	96 x 71.2 x 64.8	96 x 71.2 x 64.8
	inches	-	3.78 x 2.80 x 2.55	3.78 x 2.80 x 2.55	3.78 x 2.80 x 2.55

OVR Type 3 surge protective devices TNS/TT 230 V networks



OVR 3N 10 275

Description

Type 3 surge protective devices shall be installed as close as possible from the sensitive equipment to protect. Tested with a 1.2/50 - 8/20 current combination wave generator, they ensure a very low protection level.

Ordering details

Nb of poles	Max. discharge current I_{max} 8/20 kA	Nominal discharge current I_n kA	Voltage protection level U_p kV	Nominal voltage U_n V	Max. cont. operating voltage U_c V	Type	Order code	EAN code	Weight Pkg (1 pce) kg
								3660308	

Type 3 non-pluggable - U_c 275 V

1+1	10	3	0.9	230/400	275	OVR 1N 10 275	2CTB813912R1000	509208	0.27
3+1	10	3	0.9	230/400	275	OVR 3N 10 275	2CTB813913R1000	509215	0.48

Main dimensions mm

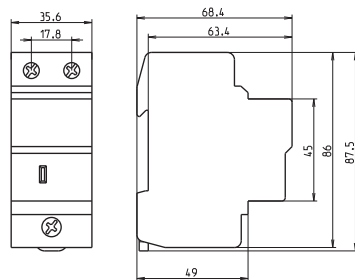

OVR 1N 10 275

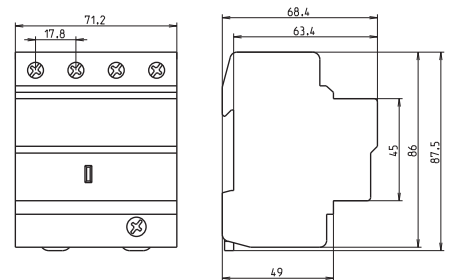



OVR 3N 10 275

Type	Width	
	mm	inches
OVR 1N 10 275	35.6	1.40
OVR 3N 10 275	71.2	2.80

OVR Type 3 surge protective devices

TNS/TT 230 V networks

General technical data

Types	OVR 1N 10 275	OVR 3N 10 275
with auxiliary contact (TS)	-	-
Technology	Varistor	Varistor
Wiring diagram		
Electrical features		
Standard	IEC 61643-1 / EN 61643-11	
Type / test class	T3 / III	
Protected lines	1+1	
Types of networks	TNS / TT	
Type of current	AC	
Nominal voltage Un (L-N/L-L)	V 230 / 400	
Max. cont. operating voltage Uc	V 275	
Maximum discharge current Imax (8/20)	kA 10	
Nominal discharge current In (8/20)	kA 3	
Combination wave Uoc	kV 6	
Voltage protection level Up at In (L-N/N-PE/L-PE)	kA 0.9 / 1.4	
Voltage protection level Up at 3 kA (L-N/N-PE/L-PE)	kA 0.9 / 0.9	
TOV (Temporary overvoltage) withstand Ut (L-N: 5 s / N-PE: 200 ms)	V 334 / 440	
Response time	ns ≤ 25	
Residual current IPE	µA 10	
Short-circuit withstand capability Isccr	kA 10	
Backup protection		
Fuse (gG - gL)	A ≤ 25	
Circuit breaker (B or C curve)	A ≤ 10	
Pluggable cartridge	No	
Integrated thermal disconnecter	Yes	
State indicator	Yes	
Safety reserve	No	
Auxiliary contact	No	
Installation		
Wire range (L, N, PE)		
Solid wire	mm ² 2.5...25	
Stranded wire	mm ² 2.5...16	
Stripping length (L, N, PE)	mm 12.5	
Tightening torque (L, N, PE)	Nm 2.5	
Auxiliary contact (TS)		
Contact complement	-	
Minimum load	-	
Maximum load	-	
Connection cross-section	mm ² -	
Miscellaneous characteristics		
Stocking and operating temperature	°C -40 to +80 / -40 to +70	
Degree of protection	IP20	
Fire resistance according to UL 94	V0	
Dimensions		
height x width x depth	mm 85 x 35.6 x 64.8	
	inches 3.35 x 1.40 x 2.55	
	mm 85 x 71.2 x 64.8	
	inches 3.35 x 2.80 x 2.55	

OVR Plus - Autoprotected surge protective devices TNS/TT 230 V networks

3



OVR PLUS N3 20
OVR PLUS N3 40

Description

OVR PLUS N3 20 and OVR PLUS N3 40 for commercial and industrial applications:

- Auto-protected: Backup miniature circuit breaker integrated and fully coordinated with the surge protective device.
- Easy installation: Fully coordinated unit with easy wiring with the complete ABB pro M modular range.
- High discharge capacity: With I_{max} 20 and 40 kA the OVR Plus N3 insure the protection of your low voltage installations and electric equipment.
- High reliability: No welding inside the module and specific thermal disconnection with the "bilame" sensor.

OVR PLUS N1 40 for residential applications:

- Auto-protected: Backup miniature circuit breaker integrated and fully coordinated with the surge protective device.
- Compact: Only two modules (36 mm width), means more space and easy wiring with the complete ABB DIN rail range.
- High discharge capacity: With I_{max} 20 and 40 kA the OVR PLUS N1 can protect your electric equipment against high surges.
- High reliability: No welding inside the module and specific thermal disconnection.

Ordering details

Protected lines	Max. discharge current I _{max} 8/20 kA	Nominal current I _n kA	Voltage protection level U _p kV	Nominal voltage U _n V	Max. cont. operating voltage U _c V	Type	Order code	EAN code	Weight Pkg (1 pce) kg
								3660308	

Type 2 autoprotected

1+1	20	5	1.3	230/400	275	OVR PLUS N1 20	2CTB803701R0700	521286	0.28
1+1	40	20	1.8	230/400	320	OVR PLUS N1 40	2CTB803701R0100	517005	0.28
3+1	20	5	1.3	230/400	320	OVR PLUS N3 20	2CTB803701R0400	517081	0.84
3+1	40	20	2.0	230/400	320	OVR PLUS N3 40	2CTB803701R0300	517074	0.84

Main dimensions mm

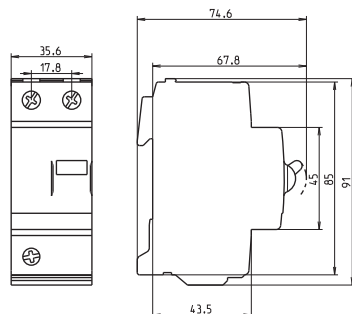

OVR Plus N1 20
OVR Plus N1 40

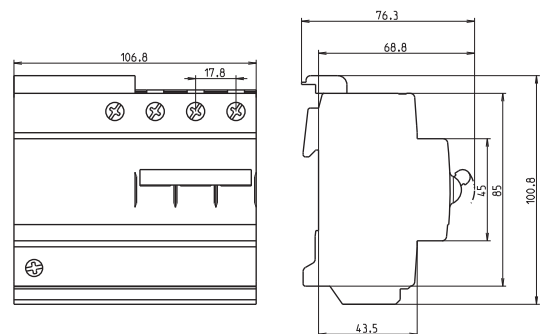

OVR Plus N3 20
OVR Plus N3 40



Type	Width	
	mm	inches
OVR PLUS N1 20	35.6	1.40
OVR PLUS N1 40	35.6	1.40
OVR PLUS N3 20	106.8	4.20
OVR PLUS N3 40	106.8	4.20

OVR Plus - Autoprotected surge protective devices

TNS/TT 230 V networks

General technical data

NEW

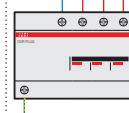
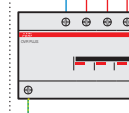
Types		OVR Plus N1 20	OVR Plus N1 40	OVR Plus N3 20	OVR Plus N3 40
with auxiliary contact (TS)		-	-	-	-
Technology		Varistor	Varistor	Varistor	Varistor
Wiring diagram					
Electrical features					
Standard		IEC 61643-1 / EN 61643-11			
Type / test class		T2 / II	T2 / II	T2 / II	T2 / II
Protected lines		1+1	1+1	3+1	3+1
Types of networks		TNS / TT	TNS / TT	TNS / TT	TNS / TT
Type of current		AC	AC	AC	AC
Nominal voltage Un (L-N/L-L)	V	230 / 400	230 / 400	230 / 400	230 / 400
Max. cont. operating voltage Uc	V	275	320	320	320
Maximum discharge current Imax (8/20)	kA	20	40	20	40
Nominal discharge current In (8/20)	kA	5	20	5	20
Voltage protection level Up at In (L-N/N-PE/L-PE)	kV	1.3 / - / 1.3	1.6 / - / 1.8	1.3 / 1.3 / 1.3	2.0 / 1.5 / 2.0
Voltage protection level Up at 3 kA (L-N/N-PE/L-PE)	kV	1.1 / - / 1.1	1.1 / - / 1.1	1.1 / 1.1 / 1.1	1.1 / 1.1 / 1.1
TOV (Temporary overvoltage) withstand Ut (L-N: 5 s / N-PE: 200 ms)	V	334 / 1200	334 / 1200	334 / 1200	334 / 1200
Response time	ns	≤ 25	≤ 25	≤ 25	≤ 25
Residual current IPE	µA	10	10	10	10
Short-circuit withstand capability Iscrc	kA	15	15	10	15
Backup protection					
Fuse (gG - gL)	A	integrated	integrated	integrated	integrated
Circuit breaker (B or C curve)	A	integrated	integrated	integrated	integrated
Pluggable cartridge		No	No	No	No
Integrated thermal disconnecter		Yes	Yes	Yes	Yes
State indicator		Yes	Yes	Yes	Yes
Safety reserve		No	No	No	No
Auxiliary contact		Yes (S2C-H6R / 2CDS200912R0001)			
Installation					
Wire range (L, N, PE)					
Solid wire	mm ²	2.5...25	2.5...25	2.5...25	2.5...25
Stranded wire	mm ²	2.5...16	2.5...16	2.5...16	2.5...16
Stripping length (L, N, PE)	mm	11	11	11	11
Tightening torque (L, N, PE)	Nm	2.5	2.5	2.5	2.5
Auxiliary contact (TS)					
Contact complement		-	-	-	-
Minimum load		-	-	-	-
Maximum load		-	-	-	-
Connection cross-section	mm ²	-	-	-	-
Miscellaneous characteristics					
Stocking and operating temperature	°C	-40 to +70 / -25 to +55	-40 to +70 / -25 to +55	-40 to +70 / -25 to +55	-40 to +70 / -25 to +55
Degree of protection		IP20	IP20	IP20	IP20
Fire resistance according to UL 94		V0	V0	V0	V0
Dimensions					
height x width x depth	mm	91 x 35.6 x 74.6	91 x 35.6 x 74.6	100.8 x 106.8 x 74.6	100.8 x 106.8 x 74.6
	inches	3.58 x 1.40 x 2.94	3.58 x 1.40 x 2.94	3.97 x 4.20 x 2.94	3.97 x 4.20 x 2.94

OVR PV surge protective devices

Photovoltaic networks

3



OVR PV T1 6.25-600 P TS



OVR PV 40-600 P

Description

Specifically designed for photovoltaic DC installations, the OVR PV family provide a safe and reliable surge and lightning protection of solar panels and converters.

The OVR PV surge protective devices comply with UTE C 61-740-51 and prEN 50539-11.

Ordering details

Protected lines	Impulse current <i>I_{imp}</i> 10/350 kA	Max. discharge current <i>I_{max}</i> 8/20 kA	Nominal current <i>I_n</i> kA	Voltage protection level <i>U_p</i> kV	Max. cont. operating voltage <i>U_{cpv}</i> V	Type	Order code	EAN code	Weight Pkg (1 pce) kg
								3660308	

Type 1 PV

2	6.25	-	6.25	1.9	670	OVR PV T1 6.25-600 P TS	2CTB803953R5700	518361	1.10
2	6.25	-	6.25	2.5	1000	OVR PV T1 6.25-1000 P TS	2CTB803953R6700	518378	1.10

Type 2 PV

2	-	40	20	1.4	670	OVR PV 40-600 P	2CTB803953R5300	516510	0.38
2	-	40	20	1.4	670	OVR PV 40-600 P TS	2CTB803953R5400	516527	0.39
2	-	40	20	3.8	1000	OVR PV 40-1000 P	2CTB803953R6400	516534	0.38
2	-	40	20	3.8	1000	OVR PV 40-1000 P TS	2CTB803953R6500	516541	0.39

Main dimensions mm

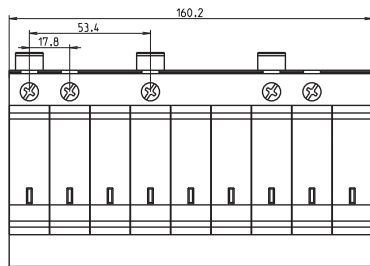

OVR PV T1 6.25-600 P TS
OVR PV T1 6.25-1000 P TS

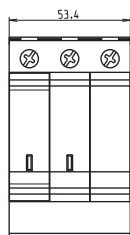
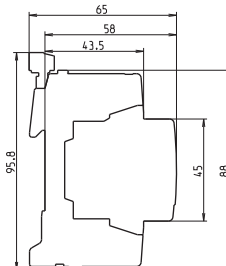

OVR PV 40-600 P

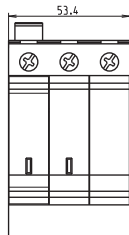

OVR PV 40-600 P TS

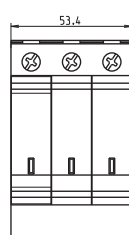

OVR PV 40-1000 P

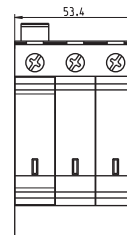

OVR PV 40-1000 P TS

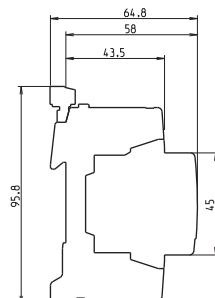



Type	Width	
	mm	inches
OVR PV T1 6.25-600 P TS	160.2	6.31
OVR PV T1 6.25-1000 P TS	160.2	6.31
OVR PV 40-600 P	53.4	2.10
OVR PV 40-600 P TS	53.4	2.10
OVR PV 40-1000 P	53.4	2.10
OVR PV 40-1000 P TS	53.4	2.10

OVR PV surge protective devices

Photovoltaic networks

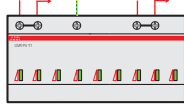
General technical data

		NEW	NEW	NEW	NEW
Types				OVR PV 40-600 P	OVR PV 40-1000 P
	with auxiliary contact (TS)	OVR PV T1 6.25-600 P TS	OVR PV T1 6.25-1000 P TS	OVR PV 40-600 P TS	OVR PV 40-1000 P TS
Technology		Varistor	Varistor	Varistor	Varistor
Wiring diagram					
Electrical features					
Standard		UTE C 61-740-51 / prEN 50539-11			
Type / test class		T1 / I	T1 / I	T2 / II	T2 / II
Protected lines		2	2	2	2
Types of networks		Photovoltaic	Photovoltaic	Photovoltaic	Photovoltaic
Type of current		DC	DC	DC	DC
Nominal voltage Un (L-N/L-L)	V	600	1000	600	1000
Max. cont. operating voltage Ucpv	V	670	1000	670	1000
Impulse current Iimp (10/350)		6.25	6.25	-	-
Maximum discharge current Imax (8/20)	kA	-	-	40	40
Nominal discharge current In (8/20)	kA	6.25	6.25	20	20
Voltage protection level Up at In	kV	1.9 / 1.9	2.5 / 2.5	2.8 / 1.4	3.8 / 3.8
Response time	ns	≤ 25	≤ 25	≤ 25	≤ 25
Residual current IPE	µA	75	75	10	75
Short-circuit DC current Iscwpv	A	100	100	100	100
Disconnector		If Iscwpv > 100 A	If Iscwpv > 100 A	If Iscwpv > 100 A	If Iscwpv > 100 A
Fuse		10AgPV (E90PV)	10AgPV (E90PV)	10AgPV (E90PV)	10AgPV (E90PV)
Circuit breaker		-	-	S802PV-S10	S804PV-S10
Pluggable cartridge		Yes	Yes	Yes	Yes
Integrated specific thermal disconnector		Yes	Yes	Yes	Yes
State indicator		Yes	Yes	Yes	Yes
Safety reserve		No	No	No	No
Auxiliary contact		Yes	Yes	Yes (TS option)	Yes (TS option)
Installation					
Wire range (L, N, PE)					
Solid wire	mm ²	2.5...25	2.5...25	2.5...25	2.5...25
Stranded wire	mm ²	2.5...16	2.5...16	2.5...16	2.5...16
Stripping length (L, N, PE)		12.2	12.2	12.2	12.2
Tightening torque (L, N, PE)		2.5	2.5	2.5	2.5
Auxiliary contact (TS)					
Contact complement		1 NO - 1 NC	1 NO - 1 NC	1 NO - 1 NC	1 NO - 1 NC
Minimum load		12 V DC - 10 mA	12 V DC - 10 mA	12 V DC - 10 mA	12 V DC - 10 mA
Maximum load		250 V AC - 1 A	250 V AC - 1 A	250 V AC - 1 A	250 V AC - 1 A
Connection cross-section		1.5	1.5	1.5	1.5
Miscellaneous characteristics					
Stocking and operating temperature	°C	-40 to +80	-40 to +80	-40 to +80	-40 to +80
Degree of protection		IP20	IP20	IP20	IP20
Fire resistance according to UL 94		V0	V0	V0	V0
Dimensions					
height x width x depth	mm	-	-	88 x 53.4 x 65	88 x 53.4 x 65
	inches	-	-	3.46 x 2.10 x 2.56	3.46 x 2.10 x 2.56
with auxiliary contact (TS)					
height x width x depth	mm	88 x 160.2 x 65	88 x 160.2 x 65	88 x 53.4 x 65	88 x 53.4 x 65
	inches	3.46 x 6.31 x 2.56	3.46 x 6.31 x 2.56	3.46 x 2.10 x 2.56	3.46 x 2.10 x 2.56

OVR WT surge protective devices

Wind turbine networks



OVR WT 3L 690 P TS



OVR WT 3L 690

Description

Due to their height, wind turbines have especially high exposure to lightning, they need high capacity and reliable lightning and surge protection.

The OVR WT family takes into consideration the specificity of wind installations with a high peak repetitive voltage withstand (U_{rp} up to 3 kV) ensure a safe protection to Wind applications.

It can be DIN mounted with the OVR WT 3L 690 P TS or fixed close to the equipments to protect with the OVR WT 3L 690 enclosure solution.

Ordering details

Protected lines	Impulse current I_{imp} 10/350 kA	Max. discharge current I_{max} 8/20 kA	Nominal current I_n kA	Voltage protection level U_p kV	Nominal voltage U_c V	Type	Order code	EAN code	Weight Pkg (1 pce) kg
								3660308	

Type 1+2 WT

3	2	40	20	6	400/690	OVR WT 3L 690	2CTB235401R0000	517050	2.56
3	2	40	20	6	400/690	OVR WT 3L 690 P TS	2CTB235402R0000	518507	1.67

Main dimensions mm

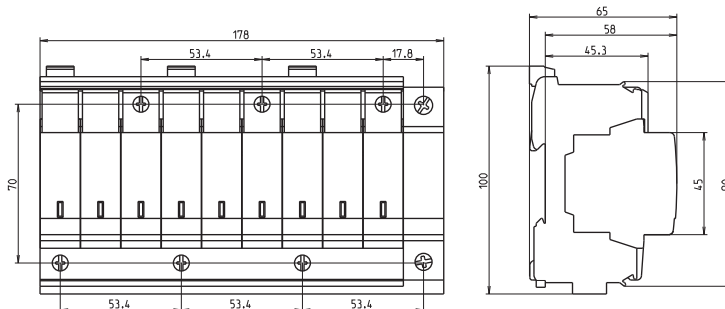

OVR WT 3L 690 P TS



Type	Width	
	mm	inches
OVR WT 3L 690	275.0	10.82
OVR WT 3L 690 P TS	178.0	7.01

OVR WT surge protective devices

Wind turbine networks

NEW

General technical data

Types	-	-
	with auxiliary contact (TS)	OVR WT 3L 690
Technology		Varistor
Wiring diagram		
		OVR WT 3L 690 P TS
		Varistor
		
Electrical features		
Standard		IEC 61643-1 / EN 61643-11
Type / test class		T1+2 / I+II
Protected lines		3
Types of networks		TNC
Type of current		AC
Nominal voltage Un (L-N/L-L)	V	400 / 690
Peak repetitive voltage withstand Urp (L-PE/L-L)	V	3000 / 3400
Max. cont. operating voltage Uc (L-PE / L-L)	V	1260 / 2520
Maximum impulse current Iimp (10/350)	kA	2
Maximum discharge current Imax (8/20)	kA	40
Nominal discharge current In (8/20)	kA	20
Follow current interrupting rating Ifi	kA	-
Voltage protection level Up at In	kV	6
Voltage protection level Up at 3 kA	kV	4.4
Response time	ns	≤ 100
Residual current IPE	µA	10
Short-circuit withstand capability Isccr	kA	50
Backup protection		
fuse (gG - gL)	A	≤ 125
circuit breaker (B or C curve)	A	≤ 125
Pluggable cartridge		Yes
Integrated thermal disconnecter		Yes
State indicator		Yes
Safety reserve		No
Auxiliary contact		Yes
Installation		
Wire range (L, N, PE)		
Solid wire	mm ²	2.5...25
Stranded wire	mm ²	2.5...16
Stripping length (L, N, PE)	mm	11
Tightening torque (L, N, PE)	Nm	2.5
Auxiliary contact (TS)		
Contact complement		1 NO - 1 NC
Minimum load		12 V DC - 10 mA
Maximum load		250 V AC - 1 A
Connection cross-section	mm ²	1.5
Miscellaneous characteristics		
Stocking and operating temperature	°C	-40 to +80
Degree of protection		IP20
Fire resistance according to UL 94		V0
Dimensions		
height x width x depth	mm	220 x 275 x 140
	inches	8.67 x 10.82 x 5.51
		100 x 178 x 65
		3.94 x 7.01 x 2.56

OVR TC surge protective devices

Data networks



OVR TC 200FR P

Description

The OVR TC family offers a reliable surge protection to dataline networks for datacenters, water treatment installations or wind turbine installations.

With the RJ11 and RJ45 bases they allow a flexible and easy installation.

Ordering details

Protected lines	Max. discharge current I_{max} 8/20 kA	Nominal / rated current I_n / I_L kA / mA	Voltage protection level U_p kV	Nominal voltage U_n V	Max. cont. operating voltage U_c V	Type	Order code	EAN code	Weight Pkg (1 pce)
								3660308	kg

Dataline protection modules

1 pair	10	5 / 140	15	6	7	OVR TC 06V P	2CTB804820R0000	515230	0.07
1 pair	10	5 / 140	20	12	14	OVR TC 12V P	2CTB804820R0100	515247	0.07
1 pair	10	5 / 140	35	24	27	OVR TC 24V P	2CTB804820R0200	515254	0.07
1 pair	10	5 / 140	70	48	53	OVR TC 48V P	2CTB804820R0300	515261	0.07
1 pair	10	5 / -	700	200	220	OVR TC 200V P	2CTB804820R0400	515278	0.07
1 pair	10	5 / 140	400	200	220	OVR TC 200FR P	2CTB804820R0500	515285	0.07

Bases

-	-	-	-	-	-	BASE OVR TC RJ11	2CTB804840R1000	515599	0.07
-	-	-	-	-	-	BASE OVR TC RJ45	2CTB804840R1100	515605	0.07

Main dimensions mm

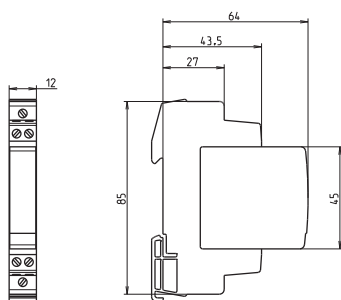







- OVR TC 06V P
- OVR TC 12V P
- OVR TC 24V P
- OVR TC 48V P
- OVR TC 200V P
- OVR TC 200FR P

Type	Width	
	mm	inches
OVR TC 06V P	12.0	0.47
OVR TC 12V P	12.0	0.47
OVR TC 24V P	12.0	0.47
OVR TC 48V P	12.0	0.47
OVR TC 200V P	12.0	0.47
OVR TC 200FR P	12.0	0.47

OVR TC surge protective devices

Data networks

General technical data

Types		OVR TC 06V P	OVR TC 12V P	OVR TC 24V P	OVR TC 48V P	OVR TC 200V P	OVR TC 200FR P
	with auxiliary contact (TS)	-	-	-	-	-	-
Connection configuration		Serial	Serial	Serial	Serial	Parallel	Serial
Wiring diagram							
Electrical features							
Standard		IEC/EN 61643-21					
Type / test class		C2	C2	C2	C2	C2	C2
Protected lines		1 pair	1 pair	1 pair	1 pair	1 pair	1 pair
Types of networks		MIC/T2 - RS422/485	RS232	LS - 4/20mA	RNIS	ADSL	RTC / Analogue
Type of current		DC	DC	DC	DC	DC	DC
Nominal voltage Un	V	6	12	24	48	200	200
Max. cont. operating voltage Uc	V	7	14	27	53	220	220
Maximum discharge current I _{max} (8/20)	kA	10	10	10	10	10	10
Nominal discharge current I _n (8/20)	kA	5	5	5	5	5	5
Voltage protection level Up at I _n	kV	15	20	35	70	700	400
Response time	ns	1	1	1	1	100	1
Rated current I _L	mA	140	140	140	140	-	140
Series resistance	Ω	10	10	10	10	-	10
Cut frequency	MHz	10	2	4	6	100	3
Pluggable cartridge		Yes	Yes	Yes	Yes	Yes	Yes
State indicator		-	-	-	-	-	-
Safety reserve		No	No	No	No	No	No
Auxiliary contact		No	No	No	No	No	No
Installation							
Wire range (L, N, PE)							
Solid wire	mm ²	1.5 / 2.5	1.5 / 2.5	1.5 / 2.5	1.5 / 2.5	1.5 / 2.5	1.5 / 2.5
Stranded wire	mm ²	-	-	-	-	-	-
Stripping length (L, N, PE)	mm	6 / 7	6 / 7	6 / 7	6 / 7	6 / 7	6 / 7
Tightening torque (L, N, PE)	Nm	0.2 / 0.4	0.2 / 0.4	0.2 / 0.4	0.2 / 0.4	0.2 / 0.4	0.2 / 0.4
Auxiliary contact (TS)							
Contact complement		-	-	-	-	-	-
Minimum load		-	-	-	-	-	-
Maximum load		-	-	-	-	-	-
Connection cross-section		-	-	-	-	-	-
Miscellaneous characteristics							
Stocking and operating temperature	°C	-40 to +80	-40 to +80	-40 to +80	-40 to +80	-40 to +80	-40 to +80
Degree of protection		IP20	IP20	IP20	IP20	IP20	IP20
Fire resistance according to UL 94		V0	V0	V0	V0	V0	V0
Dimensions							
height x width x depth	mm	85 x 12 x 64	85 x 12 x 64	85 x 12 x 64	85 x 12 x 64	85 x 12 x 64	85 x 12 x 64
	inches	8.67 x 0.47 x 1.57	8.67 x 0.47 x 1.57	8.67 x 0.47 x 1.57	8.67 x 0.47 x 1.57	8.67 x 0.47 x 1.57	8.67 x 0.47 x 1.57

LOVOS 5 surge arresters

Single pole



3

LOVOS-5/280.

Description

Most of distribution transformers are protected on the primary side with surge arresters. Representing substantial capital investment and being a key component for reliable and continuous electricity supply, the transformer should always be protected against surge damage or deterioration on the secondary side with low voltage surge arresters.

The Lovos 5 family proposes a fine surge transient protection of distribution transformers.

Ordering details

Protected lines	Max. discharge current I_{max} 8/20 kA	Nominal current I_n kA	Voltage protection level U_p kV	Nominal voltage U_n V	Max. cont. operating voltage U_c V	Type	Order code	EAN code	Weight Pkg (1 pce) kg
								3660308	

Protection of low voltage overhead lines

1	25	5	1.1	230/400	280	LOVOS-5/280			0.18
1	25	5	1.8	230/400	440	LOVOS-5/440			0.18
1	25	5	2	400/690	500	LOVOS-5/500			0.18
1	25	5	2.5	400/690	660	LOVOS-5/660			0.18
1	25	5	4	690/1000	1000	LOVOS-5/1000			0.18

Ordering example

LOVOS – 5 / 660 + 1701 + 2711

LOVOS – 5 / 660-2 + 1701 + 2719

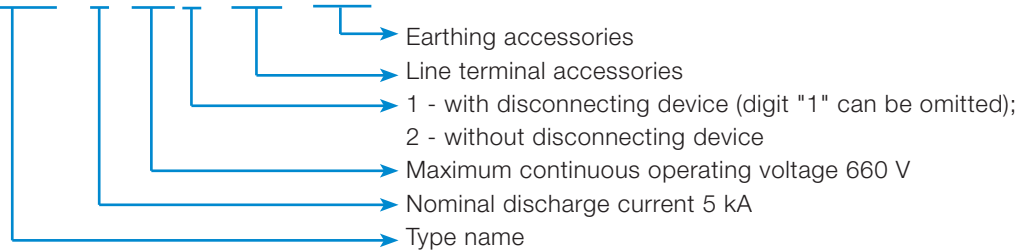

Information and orders shall be sent to:
PLABB-HV department
 Attention to Bozena Trajer

Main dimensions mm

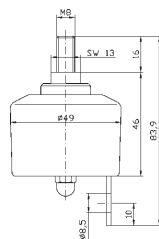





Type	Width	
	mm	inches
LOVOS-5/280	49.0	1.93
LOVOS-5/440	49.0	1.93
LOVOS-5/500	49.0	1.93
LOVOS-5/660	49.0	1.93
LOVOS-5/1000	49.0	1.93

LOVOS 5 surge arresters

Single pole

General technical data

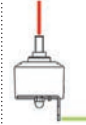
Types		LOVOS-5/280	LOVOS-5/440	LOVOS-5/500	LOVOS-5/660	LOVOS-5/1000
	with auxiliary contact (TS)	-	-	-	-	-
Technology		Varistor	Varistor	Varistor	Varistor	Varistor
Wiring diagram						
Electrical features						
Standard		IEC 61643-1 / EN 61643-11				
Type / test class		T2 / II	T2 / II	T2 / II	T2 / II	T2 / II
Protected lines		1	1	1	1	1
Types of networks		IT/TNC/TNS/TNC-S/TT	IT/TNC/TNS/TNC-S/TT	IT/TNC/TNS/TNC-S/TT	IT/TNC/TNS/TNC-S/TT	IT/TNC/TNS/TNC-S/TT
Type of current		AC	AC	AC	AC	AC
Nominal voltage Un (L-N/L-L)	V	230/400	230/400	400/690	400/690	690/1000
Max. cont. operating voltage Uc	V	280	440	500	660	1000
Maximum discharge current I _{max} (8/20)	kA	25	25	25	25	25
Nominal discharge current I _n (8/20)	kA	5	5	5	5	5
Voltage protection level Up at I _n	kV	1.1	1.8	2	2.5	4
TOV (Temporary overvoltage) withstand Ut (L-N: 5s./N-PE: 200 ms)	V	400/1440	400/1440	400/1440	400/1440	400/1440
Response time	ns	≤ 25	≤ 25	≤ 25	≤ 25	≤ 25
Residual current IPE	µA	160	160	160	160	160
Short-circuit withstand capability I _{sc}	kA	3	3	3	3	3
Energy absorption capability	J	1800	3000	3200	4000	6400
Installation						
Wire range (L, N, PE)						
Solid wire	mm ²	-	-	-	-	-
Stranded wire	mm ²	6 and 16	6 and 16	6 and 16	6 and 16	6 and 16
Stripping length (L, N, PE)	mm	from 10 up to 40	from 10 up to 40	from 10 up to 40	from 10 up to 40	from 10 up to 40
Tightening torque (L, N, PE)	Nm	10	10	10	10	10
Miscellaneous characteristics						
Stocking and operating temperature	°C	-40 to +70	-40 to +70	-40 to +70	-40 to +70	-40 to +70
Degree of protection		IP06	IP06	IP06	IP06	IP06
Degree of protection with insulated accessories		IP66	IP66	IP66	IP66	IP66
Fire resistance according to UL 94		V0	V0	V0	V0	V0

LOVOS 10 surge arresters

Single pole



LOVOS-10/280

Description

Most of distribution transformers are protected on the primary side with surge arresters. Representing substantial capital investment and being a key component for reliable and continuous electricity supply, the transformer should always be protected against surge damage or deterioration on the secondary side with low voltage surge arresters.

The Lovos 10 family propose a high surge transient protection of the distribution transformers.

Ordering details

Protected lines	Max. discharge current I_{max} 8/20 kA	Nominal current I_n kA	Voltage protection level U_p kV	Nominal voltage U_n V	Max. cont. operating voltage U_c V	Type	Order code	EAN code	Weight Pkg (1 pce) kg
								3660308	

Follow current interrupting rating 50 kA

1	40	10	1.1	230/400	280	LOVOS-10/280			0.18
1	40	10	1.8	230/400	440	LOVOS-10/440			0.18
1	40	10	2	400/690	500	LOVOS-10/500			0.18
1	40	10	2.5	400/690	660	LOVOS-10/660			0.18
1	40	10	4	690/1000	1000	LOVOS-10/1000			0.18

Ordering example

LOVOS – 10 / 660 + 1701 + 2711

LOVOS – 10 / 660-2 + 1701 + 2719

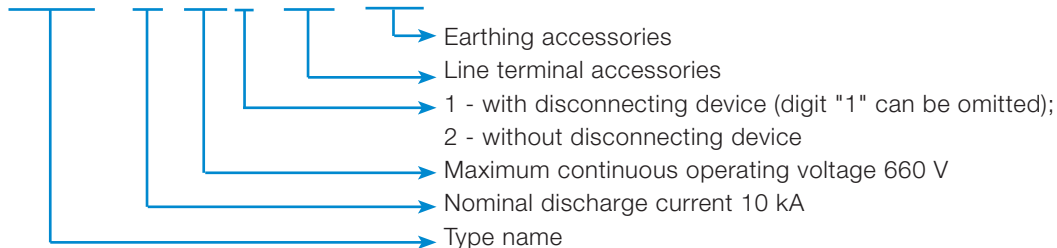

Information and orders shall be sent to:
PLABB-HV department
 Attention to Bozena Trajer

Main dimensions mm

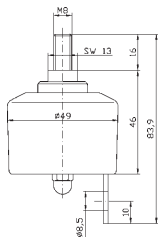





Type	Width	
	mm	inches
LOVOS-10/280	49.0	1.93
LOVOS-10/440	49.0	1.93
LOVOS-10/500	49.0	1.93
LOVOS-10/660	49.0	1.93
LOVOS-10/1000	49.0	1.93

LOVOS 10 surge arresters

Single pole

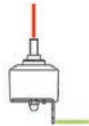
General technical data

Types	LOVOS-10/280	LOVOS-10/440	LOVOS-10/500	LOVOS-10/660	LOVOS-10/1000
with auxiliary contact (TS)	-	-	-	-	-
Technology	Varistor	Varistor	Varistor	Varistor	Varistor
Wiring diagram					
Electrical features					
Standard	IEC 61643-1 / EN 61643-11				
Type / test class	T2 / II	T2 / II	T2 / II	T2 / II	T2 / II
Protected lines	1	1	1	1	1
Types of networks	IT/TNC/TNS/TNC-S/TT	IT/TNC/TNS/TNC-S/TT	IT/TNC/TNS/TNC-S/TT	IT/TNC/TNS/TNC-S/TT	IT/TNC/TNS/TNC-S/TT
Type of current	AC	AC	AC	AC	AC
Nominal voltage Un (L-N/L-L)	V 230/400	230/400	400/690	400/690	690/1000
Max. cont. operating voltage Uc	V 280	440	500	660	1000
Maximum discharge current Imax (8/20)	kA 40	40	40	40	40
Nominal discharge current In (8/20)	kA 10	10	10	10	10
Voltage protection level Up at In	kV 1.1	1.8	2	2.5	4
TOV (Temporary overvoltage) withstand Ut (L-N: 5s./N-PE: 200ms)	V 400/1440	400/1440	400/1440	400/1440	400/1440
Response time	ns ≤ 25	≤ 25	≤ 25	≤ 25	≤ 25
Residual current IPE	µA 300	300	300	300	300
Short-circuit withstand capability Isccr	kA 3	3	3	3	3
Energy absorption capability	J 2200	3300	3900	4500	7800
Installation					
Wire range (L, N, PE)					
Solid wire	mm² -	-	-	-	-
Stranded wire	mm² 6 and 16	6 and 16	6 and 16	6 and 16	6 and 16
Stripping length (L, N, PE)	mm from 10 up to 40	from 10 up to 40	from 10 up to 40	from 10 up to 40	from 10 up to 40
Tightening torque (L, N, PE)	Nm 10	10	10	10	10
Miscellaneous characteristics					
Stocking and operating temperature	°C -40 to +70	-40 to +70	-40 to +70	-40 to +70	-40 to +70
Degree of protection	IP06	IP06	IP06	IP06	IP06
Degree of protection with insulated accessories	IP66	IP66	IP66	IP66	IP66
Fire resistance according to UL 94	V0	V0	V0	V0	V0

OPR external air terminal lightning protection

30 μ s and 60 μ s efficiency



OPR 30

3



OPR 60

Description

The unique efficiency of the OPR early streamer emission air terminal (ESEAT) is based on the difference (ΔT), measured in a laboratory, in between the emission time of the OPR and the one from a simple rod.

The OPR ESE air terminal is composed of a striking point connected to two down conductors to conduct the lightning to the ground.

During a storm the ambient electric field may rise from 600 V to 10-20 kV/m. When the electric field reaches this level representing a minimum risk for a lightning, the OPR begins to get activated and generates high voltage pulses, helping to create and propagating an upward leader.

After a strike on the OPR, the lightning current is driven to ground by the down conductor to the earth termination system.

The radius of protection (R_p) of the OPR is calculated according to the NF C17-102 (edition 2011). It depends on the OPR efficiency (ΔT) expressed in micro-seconds. The maximum value for ΔT is 60 μ s by standard.

The risk assessment shall be calculated according to the NF C17-102 Annex A / IEC 62305-2 and will define the protection level (LPL I, II, III or IV) which will be used in the determination of the OPR radius of protection.

Ordering details

OPR efficiency	L	Description	Type	Order code	EAN code	Weight
ΔT	mm				3660308	Pkg (1 pce)
μ s						kg
30	216.5	OPR 30 without mast	OPR 30	2CTB899800R7000	514172	2.19
60	216.5	OPR 60 without mast	OPR 60	2CTB899800R7100	514189	2.36
-	2300.0	Mast support for OPR	Mast 2M30	2CTH070002R0000	521668	3.30

Main dimensions mm

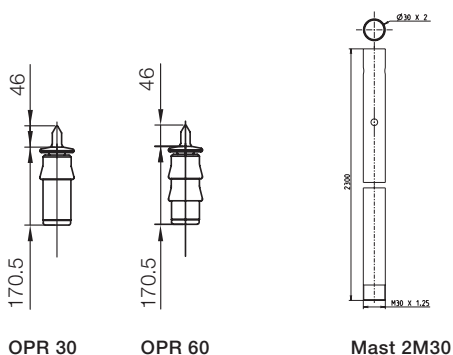

Type	Width	
	mm	inches
OPR 30 without mast	216.5	8.52
OPR 60 without mast	216.5	8.52
Mast 2M30	2300.0	90.55

OPR external air terminal lightning protection 30 μs and 60 μs efficiency

General technical data

OPR radius of protection

Level of protection	LPL I		LPL II		LPL III		LPL IV	
Rolling sphere radius r (m)	20		30		45		60	
Types	OPR 30	OPR 60	OPR 30	OPR 60	OPR 30	OPR 60	OPR 30	OPR 60
h (m)	Radius of protection Rp (m)							
2	19	31	22	35	25	39	28	43
3	29	47	33	52	38	58	43	64
4	38	63	44	69	51	78	57	85
5	48	79	55	86	63	97	71	107
6	48	79	55	87	64	97	72	107
8	49	79	56	87	65	98	73	108
10	49	79	57	88	66	99	75	109
15	50	80	58	89	69	101	78	111
20	50	80	59	89	71	102	81	113
45	43	76	58	89	75	105	89	119
50	40	74	57	88	75	105	89	120
55	36	72	55	86	74	105	90	120
60	30	69	52	85	73	104	90	120

3



ABB OPR Designer: The easy way for your surge and lightning protection
 ABB is happy to provide you with the new design software for your surge and lightning protection. This software will help you in designing a complete lightning protection system solution for a building, in positioning the right external lightning air terminal including all the accessories and in selecting the right surge protection to protect all your installations.

CREATE YOUR TECHNICAL STUDY IN ONE CLICK!

Click on the button to install the application (26Mb)
 A shortcut will be added to your desktop to launch the application directly.

Minimal configuration requirements: Windows (XP, Vista, Seven) or Apple (OSX) and Java 1.6

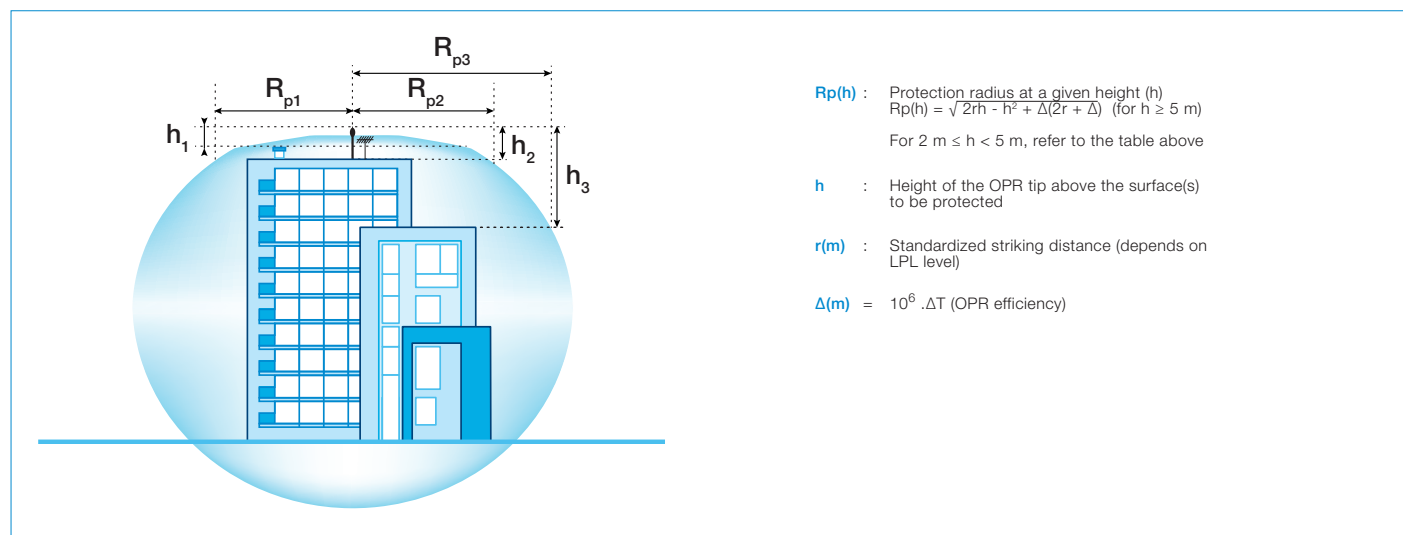
OPR Designer software
<http://www.web-edia.com/opr>

Surge and lightning protection solutions

Selection table

Protected lines	Impulse current Iimp 10/350 kA	Max. discharge current Imax 8/20 kA	Nominal current In kA	Follow current interrupting rating Ifi kA	Voltage protection level Up kV	Nominal voltage Un V	Max. cont. operating voltage Uc V	Type	Order code	EAN code	Pkg qty	Weight (1 pce)
-----------------	---------------------------------------------	--------------------------------------------------	---------------------------------	-----------------------------------------------------	------------------------------------------	--------------------------------	---------------------------------------------	------	------------	----------	---------	----------------

3660308

kg

Type 1 OVR

limp 25 kA

1	25	-	25	50	2.5	400/690	440	OVR T1 25-440-50	2CTB815101R9300	514929	1	0.31
1	25	-	25	50	2.5	230/400	255	OVR T1 25-255	2CTB815101R0100	510877	1	0.31
2	25	-	25	50	2.5	230/400	255	OVR T1 2L 25-255	2CTB815101R1200	510891	1	0.63
2	25	-	25	50	2.5	230/400	255	OVR T1 2L 25-255 TS	2CTB815101R1100	510945	1	0.64
3	25	-	25	50	2.5	230/400	255	OVR T1 3L 25-255	2CTB815101R1300	510907	1	0.94
3	25	-	25	50	2.5	230/400	255	OVR T1 3L 25-255 TS	2CTB815101R0600	510952	1	1.00
4	25	-	25	50	2.5	230/400	255	OVR T1 4L 25-255	2CTB815101R1400	510914	1	1.16
4	25	-	25	50	2.5	230/400	255	OVR T1 4L 25-255 TS	2CTB815101R0800	510969	1	1.26
1+1	25	-	25	50	2.5	230/400	255	OVR T1 1N 25-255	2CTB815101R1500	510921	1	0.53
1+1	25	-	25	50	2.5	230/400	255	OVR T1 1N 25-255 TS	2CTB815101R1000	510976	1	0.64
3+1	25	-	25	50	2.5	230/400	255	OVR T1 3N 25-255	2CTB815101R1600	510938	1	1.16
3+1	25	-	25	50	2.5	230/400	255	OVR T1 3N 25-255 TS	2CTB815101R0700	510983	1	1.26
1	25	-	25	7	2.5	230/400	255	OVR T1 25-255-7	2CTB815101R8700	514110	1	0.16
3+1	25	-	25	7	2.5	230/400	255	OVR T1 3N 25-255-7	2CTB815101R8800	514127	1	0.84

Neutral

1	25	-	25	-	4	400/690	690	OVR T1 25 N	2CTB815101R9700	517043	1	0.15
1	50	-	50	-	1.5	230/400	255	OVR T1 50 N	2CTB815101R0400	510853	1	0.29
1	100	-	25	-	2	230/400	255	OVR T1 100 N	2CTB815101R0500	510860	1	0.29

Type 1+2 OVR

limp 25 and 15 kA

1	25	60	25	15	1.5	230/400	255	OVR T1+2 25-255 TS	2CTB815101R0300	510884	1	0.27
1	15	60	15	7	1.7	230/400	255	OVR T1+2 15-255-7	2CTB815101R8900	514134	1	0.16
3+1	15	60	15	7	1.7	230/400	255	OVR T1+2 3N 15-255-7	2CTB815101R9000	514141	1	0.84
1	15	100	5	-	1.4	230/400	440	OVR HL 15-440s P TS	2CTB815201R0800	509802	1	0.32
2	15	100	5	-	1.4	230/400	440	OVR HL 2L 15-440s P TS	2CTB815303R0400	509826	1	0.63
3	15	100	5	-	1.4	230/400	440	OVR HL 3L 15-440s P TS	2CTB815401R0400	509833	1	0.94
4	15	100	5	-	1.4	230/400	440	OVR HL 4L 15-440s P TS	2CTB815503R0400	509840	1	1.26
1	15	-	-	-	-	230/400	440	OVR HL 15-440s C	2CTB815250R0300	509857	1	0.02

limp 7 kA

1	7	70	7	-	1.4	230/400	275	OVR T1+2 7-275s P	2CTB815101R3900	513403	1	0.17
3	7	70	7	-	1.4	230/400	275	OVR T1+2 3L 7-275s P	2CTB815101R4000	513410	1	0.48
4	7	70	7	-	1.4	230/400	275	OVR T1+2 4L 7-275s P	2CTB815101R4100	513427	1	0.63
1+1	7	70	7	-	1.4	230/400	275	OVR T1+2 1N 7-275s P	2CTB815302R1000	515728	1	0.32
3+1	7	70	7	-	1.4	230/400	275	OVR T1+2 3N 7-275s P	2CTB815502R1000	515735	1	0.63
1	7	-	-	-	-	230/400	275	OVR T1+2 7-275s C	2CTB815101R3800	513458	1	0.07
1	7	-	-	-	-	230/400	255	OVR T1+2 70 NC	2CTB815101R5100	515742	1	0.07

Type 2 OVR monobloc

1	-	20	5	-	1.0	120/240	150	OVR T2 20-150	2CTB804200R0700	518057	1	0.12
1	-	40	20	-	1.4	120/240	150	OVR T2 40-150	2CTB804201R0700	518064	1	0.12
1	-	20	5	-	1.0	230/400	275	OVR T2 20-275	2CTB804200R0100	514882	1	0.12
1	-	40	20	-	1.4	230/400	275	OVR T2 40-275	2CTB804201R0100	514103	1	0.12
3	-	20	5	-	1.0	230/400	275	OVR T2 3L 20-275	2CTB804600R0400	515957	1	0.35
3	-	40	20	-	1.4	230/400	275	OVR T2 3L 40-275	2CTB804601R0400	515964	1	0.35
4	-	20	5	-	1.0	230/400	275	OVR T2 4L 20-275	2CTB804600R0500	515971	1	0.45
4	-	40	20	-	1.4	230/400	275	OVR T2 4L 40-275	2CTB804601R0500	515988	1	0.45
1	-	20	5	-	1.3	230/400	440	OVR T2 20-440	2CTB804200R0200	518071	1	0.12
1	-	40	20	-	1.9	230/400	440	OVR T2 40-440	2CTB804201R0200	518088	1	0.12
1	-	20	5	-	1.0	120/240	150	OVR T2 20-150 (x20)	2CTB804200R1700	519405	20	0.12
1	-	40	20	-	1.4	120/240	150	OVR T2 40-150 (x20)	2CTB804201R1700	519436	20	0.12
1	-	20	5	-	1.0	230/400	275	OVR T2 20-275 (x20)	2CTB804200R1100	519382	20	0.12
1	-	40	20	-	1.4	230/400	275	OVR T2 40-275 (x20)	2CTB804201R1100	519412	20	0.12
3	-	20	5	-	1.0	230/400	275	OVR T2 3L 20-275 (x6)	2CTB804600R1400	519443	6	0.35
3	-	40	20	-	1.4	230/400	275	OVR T2 3L 40-275 (x6)	2CTB804601R1400	519467	6	0.35
4	-	20	5	-	1.0	230/400	275	OVR T2 4L 20-275 (x5)	2CTB804600R1500	519450	5	0.45
4	-	40	20	-	1.4	230/400	275	OVR T2 4L 40-275 (x5)	2CTB804601R1500	519474	5	0.45
1	-	20	5	-	1.3	230/400	440	OVR T2 20-440 (x20)	2CTB804200R1200	519399	20	0.12
1	-	40	20	-	1.9	230/400	440	OVR T2 40-440 (x20)	2CTB804201R1200	519429	20	0.12

Surge and lightning protection solutions

Selection table

Protected lines	Impulse current <i>I_{imp}</i> 10/350 kA	Max. discharge current <i>I_{max}</i> 8/20 kA	Nominal current <i>I_n</i> kA	Follow current interrupting rating <i>I_{fi}</i> kA	Voltage protection level <i>U_p</i> kV	Nominal voltage <i>U_n</i> V	Max. cont. operating voltage <i>U_c</i> V	Type	Order code	EAN code	Pkg qty	Weight (1 pce)
										3660308		kg

Type 2 OVR pluggable

Uc 75 V

1	-	15	5	-	0.3	57	75	OVR T2 15-75 P	2CTB803851R2800	518446	1	0.12
1	-	15	5	-	0.3	57	75	OVR T2 15-75 P TS	2CTB803851R2700	518453	1	0.12
2	-	15	5	-	0.3	57	75	OVR T2 2L 15-75 P	2CTB803852R1700	518484	1	0.23
2	-	15	5	-	0.3	57	75	OVR T2 2L 15-75 P TS	2CTB803852R1600	518477	1	0.23

Uc 275 V

1	-	15	5	-	1.0	230/400	275	OVR T2 15-275 P	2CTB803851R2400	512840	1	0.12
1	-	40	20	-	1.4	230/400	275	OVR T2 40-275 P	2CTB803851R2300	512833	1	0.12
1	-	40	20	-	1.4	230/400	275	OVR T2 40-275 P TS	2CTB803851R1700	514363	1	0.12
1	-	40	20	-	1.4	230/400	275	OVR T2 40-275s P	2CTB803851R2000	512826	1	0.12
1	-	40	20	-	1.4	230/400	275	OVR T2 40-275s P TS	2CTB803851R1400	512802	1	0.12
1	-	70	30	-	1.5	230/400	275	OVR T2 70-275s P	2CTB803851R1900	512819	1	0.12
1	-	70	30	-	1.5	230/400	275	OVR T2 70-275s P TS	2CTB803851R1300	512796	1	0.12
3	-	15	5	-	1.0	230/400	275	OVR T2 3L 15-275 P	2CTB803853R3400	512987	1	0.35
3	-	40	20	-	1.4	230/400	275	OVR T2 3L 40-275 P	2CTB803853R2400	513366	1	0.35
3	-	40	20	-	1.4	230/400	275	OVR T2 3L 40-275 P TS	2CTB803853R2500	514400	1	0.35
3	-	40	20	-	1.4	230/400	275	OVR T2 3L 40-275s P	2CTB803853R2200	512963	1	0.35
3	-	40	20	-	1.4	230/400	275	OVR T2 3L 40-275s P TS	2CTB803853R2300	512970	1	0.35
3	-	70	30	-	1.5	230/400	275	OVR T2 3L 70-275s P	2CTB803853R4100	512994	1	0.35
3	-	70	30	-	1.5	230/400	275	OVR T2 3L 70-275s P TS	2CTB803853R4400	513007	1	0.35
4	-	15	5	-	1.0	230/400	275	OVR T2 4L 15-275 P	2CTB803853R6000	513038	1	0.45
4	-	40	20	-	1.4	230/400	275	OVR T2 4L 40-275 P	2CTB803853R5600	513274	1	0.45
4	-	40	20	-	1.4	230/400	275	OVR T2 4L 40-275 P TS	2CTB803853R5200	514417	1	0.45
4	-	40	20	-	1.4	230/400	275	OVR T2 4L 40-275s P	2CTB803853R5400	513021	1	0.45
4	-	40	20	-	1.4	230/400	275	OVR T2 4L 40-275s P TS	2CTB803853R5000	513014	1	0.45
4	-	70	30	-	1.5	230/400	275	OVR T2 4L 70-275s P	2CTB803919R0200	513045	1	0.45
4	-	70	30	-	1.5	230/400	275	OVR T2 4L 70-275s P TS	2CTB803919R0400	513052	1	0.45
1+1	-	15	5	-	1.0	230/400	275	OVR T2 1N 15-275 P	2CTB803952R1200	513106	1	0.25
1+1	-	40	20	-	1.4	230/400	275	OVR T2 1N 40-275 P	2CTB803952R1100	513250	1	0.25
1+1	-	40	20	-	1.4	230/400	275	OVR T2 1N 40-275 P TS	2CTB803952R0500	514387	1	0.25
1+1	-	40	20	-	1.4	230/400	275	OVR T2 1N 40-275s P	2CTB803952R0800	513090	1	0.25
1+1	-	40	20	-	1.4	230/400	275	OVR T2 1N 40-275s P TS	2CTB803952R0200	513076	1	0.25
1+1	-	70	30	-	1.5	230/400	275	OVR T2 1N 70-275s P TS	2CTB803952R0100	513069	1	0.25
1+1	-	70	30	-	1.5	230/400	275	OVR T2 1N 70-275s P	2CTB803952R0700	513083	1	0.25
3+1	-	15	5	-	1.0	230/400	275	OVR T2 3N 15-275 P	2CTB803953R1200	513151	1	0.45
3+1	-	40	20	-	1.4	230/400	275	OVR T2 3N 40-275 P	2CTB803953R1100	513267	1	0.45
3+1	-	40	20	-	1.4	230/400	275	OVR T2 3N 40-275 P TS	2CTB803953R0500	514394	1	0.45
3+1	-	40	20	-	1.4	230/400	275	OVR T2 3N 40-275s P	2CTB803953R0800	513144	1	0.45
3+1	-	40	20	-	1.4	230/400	275	OVR T2 3N 40-275s P TS	2CTB803953R0200	513120	1	0.45
3+1	-	70	30	-	1.5	230/400	275	OVR T2 3N 70-275s P	2CTB803953R0700	513137	1	0.45
3+1	-	70	30	-	1.5	230/400	275	OVR T2 3N 70-275s P TS	2CTB803953R0100	513113	1	0.45

Surge and lightning protection solutions

Selection table

Protected lines	Impulse current Iimp 10/350 kA	Max. discharge current Imax 8/20 kA	Nominal current In kA	Follow current interrupting rating I _{fi} kA	Voltage protection level Up kV	Nominal voltage Un V	Max. cont. operating voltage Uc V	Type	Order code	EAN code	Pkg qty	Weight (1 pce)
										3660308		kg
Uc 440 V												
1	-	15	5	-	1.3	230/400	440	OVR T2 15-440 P	2CTB803851R1100	512772	1	0.12
1	-	40	20	-	1.9	230/400	440	OVR T2 40-440 P	2CTB803851R1200	512789	1	0.12
1	-	40	20	-	1.9	230/400	440	OVR T2 40-440 P TS	2CTB803851R0500	514370	1	0.12
1	-	40	20	-	1.9	230/400	440	OVR T2 40-440s P	2CTB803851R0800	512765	1	0.12
1	-	40	20	-	1.9	230/400	440	OVR T2 40-440s P TS	2CTB803851R0200	512741	1	0.12
1	-	70	30	-	2.0	230/400	440	OVR T2 70-440s P	2CTB803851R0700	512758	1	0.12
1	-	70	30	-	2.0	230/400	440	OVR T2 70-440s P TS	2CTB803851R0100	512734	1	0.12
1	-	120	60	-	2.5	230/400	440	OVR T2 120-440s P TS	2CTB803951R1300	517067	1	0.25
3	-	40	20	-	1.9	230/400	440	OVR T2 3L 40-440 P	2CTB803853R2600	516879	1	0.45
3	-	40	20	-	1.9	230/400	440	OVR T2 3L 40-440 P TS	2CTB803853R2000	516886	1	0.45
3	-	70	30	-	2.0	230/400	440	OVR T2 3L 70-440s P	2CTB803853R4200	516893	1	0.45
3	-	70	30	-	2.0	230/400	440	OVR T2 3L 70-440s P TS	2CTB803853R4300	516909	1	0.45
4	-	40	20	-	1.9	230/400	440	OVR T2 4L 40-440 P	2CTB803853R5100	516916	1	0.48
4	-	40	20	-	1.9	230/400	440	OVR T2 4L 40-440 P TS	2CTB803853R5300	516923	1	0.48
4	-	70	30	-	2.0	230/400	440	OVR T2 4L 70-440s P	2CTB803853R7000	516930	1	0.48
4	-	70	30	-	2.0	230/400	440	OVR T2 4L 70-440s P TS	2CTB803853R7100	516947	1	0.48
3+1	-	15	5	-	1.3	230/400	440	OVR T2 3N 15-440 P	2CTB803953R1300	516880	1	0.48
3+1	-	40	20	-	1.9	230/400	440	OVR T2 3N 40-440 P	2CTB803953R1400	516817	1	0.48
3+1	-	40	20	-	1.9	230/400	440	OVR T2 3N 40-440 P TS	2CTB803953R1500	516824	1	0.48
3+1	-	40	20	-	1.9	230/400	440	OVR T2 3N 40-440s P TS	2CTB803953R1600	516831	1	0.48
3+1	-	70	30	-	2.0	230/400	440	OVR T2 3N 70-440s P	2CTB803953R1700	516848	1	0.48
3+1	-	70	30	-	2.0	230/400	440	OVR T2 3N 70-440s P TS	2CTB803953R1800	516855	1	0.48
3	-	40	20	-	3.0	400/690	440	OVR T2 3L 40-440/690 P	2CTB803853R4500	515629	1	0.48
3	-	40	20	-	3.0	400/690	440	OVR T2 3L 40-440/690 P TS	2CTB803853R4600	515636	1	0.48
Neutral												
1	-	70	30	-	1.4	230/400	255	OVR T2 70 N P	2CTB803953R1900	516862	1	0.12
Cartridges												
1	-	15	-	-	-	57	75	OVR T2 15-75 C	2CTB803854R1400	518491	1	0.12
1	-	15	-	-	-	230/400	275	OVR T2 15-275 C	2CTB803854R1200	513168	1	0.12
1	-	40	-	-	-	230/400	275	OVR T2 40-275 C	2CTB803854R1000	513182	1	0.12
1	-	40	-	-	-	230/400	275	OVR T2 40-275s C	2CTB803854R0900	513199	1	0.12
1	-	70	-	-	-	230/400	275	OVR T2 70-275s C	2CTB803854R0700	513229	1	0.12
1	-	15	-	-	-	230/400	440	OVR T2 15-440 C	2CTB803854R0600	513175	1	0.12
1	-	40	-	-	-	230/400	440	OVR T2 40-440 C	2CTB803854R0400	513205	1	0.12
1	-	40	-	-	-	230/400	440	OVR T2 40-440s C	2CTB803854R0300	513212	1	0.12
1	-	70	-	-	-	230/400	440	OVR T2 70-440s C	2CTB803854R0100	513236	1	0.12
1	-	70	-	-	-	230/400	255	OVR T2 70 N C	2CTB803854R0000	513243	1	0.07
Type 2 autoprotected												
1+1	-	20	5	-	1.3	230/400	275	OVR PLUS N1 20	2CTB803701R0700	521286	1	0.28
1+1	-	40	20	-	1.8	230/400	320	OVR PLUS N1 40	2CTB803701R0100	517005	1	0.28
3+1	-	20	5	-	1.3	230/400	320	OVR PLUS N3 20	2CTB803701R0400	517081	1	0.84
3+1	-	40	20	-	2.0	230/400	320	OVR PLUS N3 40	2CTB803701R0300	517074	1	0.84
Type 3 OVR												
Combination wave Uoc 6 kV												
1+1	-	10	3	-	0.9	230/400	275	OVR 1N 10 275	2CTB813912R1000	509208	1	0.27
3+1	-	10	3	-	0.9	230/400	275	OVR 3N 10 275	2CTB813913R1000	509215	1	0.48

Surge and lightning protection solutions

Selection table

Protected lines	Impulse current Iimp 10/350 kA	Max. discharge current Imax 8/20 kA	Rated current IL mA	Nominal current In kA	Nominal voltage Un V	Voltage protection level Up kV	Max. cont. operating voltage Uc(pv) V	Short-circuit DC current withstand Iscwpv A	Peak repetitive voltage withstand Urp V	Type	Order code	EAN code	Pkg qty	Weight (1 pce)
												3660308		kg

Type 1 OVR photovoltaic

2	6.25	-	-	6.25	-	1.9	670	100	-	OVR PV T1 6.25-600 P TS	2CTB803953R5700	518361	1	1.10
2	6.25	-	-	6.25	-	2.5	1000	100	-	OVR PV T1 6.25-1000 P TS	2CTB803953R6700	518378	1	1.10

Type 2 OVR photovoltaic

2	-	40	-	20	-	1.4	670	100	-	OVR PV 40-600 P	2CTB803953R5300	516510	1	0.38
2	-	40	-	20	-	1.4	670	100	-	OVR PV 40-600 P TS	2CTB803953R5400	516527	1	0.39
2	-	40	-	20	-	3.8	1000	100	-	OVR PV 40-1000 P	2CTB803953R6400	516534	1	0.38
2	-	40	-	20	-	3.8	1000	100	-	OVR PV 40-1000 P TS	2CTB803953R6500	516541	1	0.39

Cartridges

-	6.25	-	-	-	-	-	600	-	-	OVR PV T1 6.25-600 C	2CTB803950R1000	518978	1	0.24
-	6.25	-	-	-	-	-	1000	-	-	OVR PV T1 6.25-1000 C	2CTB803950R1100	518989	1	0.24
-	-	40	-	-	-	-	600	-	-	OVR PV 40-600 C	2CTB803950R0000	516558	1	0.12
-	-	40	-	-	-	-	1000	-	-	OVR PV 40-1000 C	2CTB803950R0100	516565	1	0.12
-	-	-	-	-	-	-	-	-	-	OVR PV MC	2CTB803950R0300	516756	1	0.12

Type 1+2 OVR wind turbine

3	2	40	-	20	400/690	6	1260	-	3000	OVR WT 3L 690	2CTB235401R0000	517050	1	2.56
3	2	40	-	20	400/690	6	1260	-	3000	OVR WT 3L 690 P TS	2CTB235402R0000	518507	1	1.67

Dataline OVR protection

1 pair	-	10	140	5	6	15	7	-	-	OVR TC 06V P	2CTB804820R0000	515230	1	0.07
1 pair	-	10	140	5	12	20	14	-	-	OVR TC 12V P	2CTB804820R0100	515247	1	0.07
1 pair	-	10	140	5	24	35	27	-	-	OVR TC 24V P	2CTB804820R0200	515254	1	0.07
1 pair	-	10	140	5	48	70	53	-	-	OVR TC 48V P	2CTB804820R0300	515261	1	0.07
1 pair	-	10	-	5	200	700	220	-	-	OVR TC 200V P	2CTB804820R0400	515278	1	0.07
1 pair	-	10	140	5	200	400	220	-	-	OVR TC 200FR P	2CTB804820R0500	515285	1	0.07
-	-	-	-	-	-	-	-	-	-	BASE OVR TC RJ11	2CTB804840R1000	515599	1	0.07
-	-	-	-	-	-	-	-	-	-	BASE OVR TC RJ45	2CTB804840R1100	515605	1	0.07

Cartridges

-	-	10	-	5	6	-	7	-	-	OVR TC 06V C	2CTB804821R0000	515292	1	0.04
-	-	10	-	5	12	-	14	-	-	OVR TC 12V C	2CTB804821R0100	515308	1	0.04
-	-	10	-	5	24	-	27	-	-	OVR TC 24V C	2CTB804821R0200	515315	1	0.04
-	-	10	-	5	48	-	53	-	-	OVR TC 48V C	2CTB804821R0300	515322	1	0.04
-	-	10	-	5	200	-	220	-	-	OVR TC 200V C	2CTB804821R0400	515339	1	0.04

LOVOS surge arresters

1	-	25	-	5	230/400	1.1	280	-	-	LOVOS-5/280	Place orders to: PLABB-HV department Attn.: Bozena Trajer			0.18
1	-	25	-	5	230/400	1.8	440	-	-	LOVOS-5/440				0.18
1	-	25	-	5	400/690	2	500	-	-	LOVOS-5/500				0.18
1	-	25	-	5	400/690	2.5	660	-	-	LOVOS-5/660				0.18
1	-	25	-	5	690/1000	4	1000	-	-	LOVOS-5/1000				0.18
1	-	40	-	10	230/400	1.1	280	-	-	LOVOS-10/280				0.18
1	-	40	-	10	230/400	1.8	440	-	-	LOVOS-10/440				0.18
1	-	40	-	10	400/690	2	500	-	-	LOVOS-10/500				0.18
1	-	40	-	10	400/690	2.5	660	-	-	LOVOS-10/660				0.18
1	-	40	-	10	690/1000	4	1000	-	-	LOVOS-10/1000				0.18

OPR air terminal

OPR efficiency	L	Description	Type	Order code	EAN code	Pkg qty	Weight (1 pce)
ΔT							
μs	mm				3660308		kg
30	216.5	OPR 30 without mast	OPR 30	2CTB899800R7000	514172	1	2.19
60	216.5	OPR 60 without mast	OPR 60	2CTB899800R7100	514189	1	2.36
-	2300.0	Mast support for OPR	Mast 2M30	2CTH070002R0000	521668	1	3.30

Applications Industrial

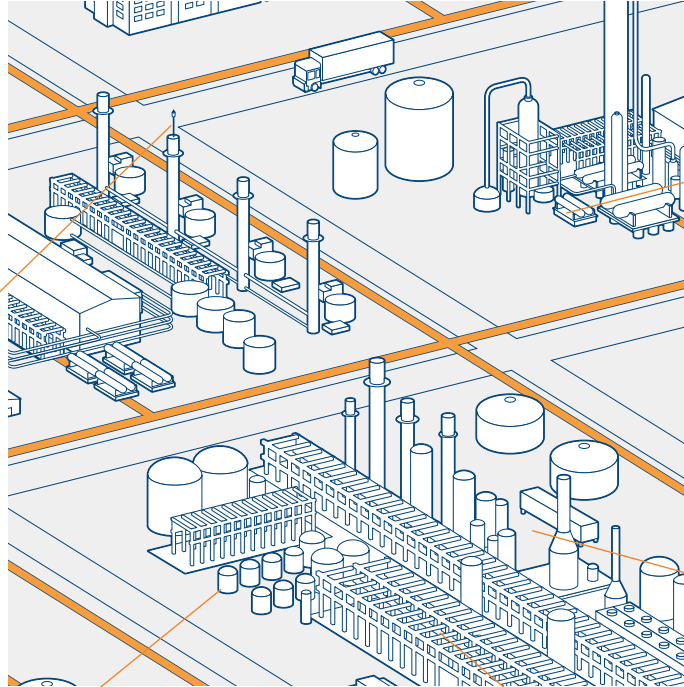

Dataline protection

OVR TC 48 V P
2CTB804820R0300



Main-distribution board

OVR T1 3N 25-255 TS
2CTB815101R0700



Distribution transformer

LOVOS 10/440

5

External lightning protection





OPR 60 + mast 2M30
2CTB899800R7100 +
2CTH070002R0000



Sub-distribution board

OVR T2 3N 40-275 P TS
2CTB803953R0500

Equipment protection in industrial market

	Description	Impulse current I_{imp} (10/350)	Follow current I_n	Max. discharge current I_{max} (8/20)	Nominal discharge current I_n	Nominal voltage U_n	Protection level U_p
	OVR T1 3N 25-255 TS 2CTB815101R0700	25 kA	50 kA	–	25 kA	230 V	2.5 kV
	OVR T2 3N 40-275 P TS 2CTB803953R0500	–	–	40 kA	20 kA	230 V	1.4 kV
	OVR TC 48V P 2CTB804820R0300	–	–	10 kA	5 kA	48 V	70 V
	LOVOS 10/440	Please contact your ABB High Voltage department		40 kA	10 kA	230 V	1.8 kV
	OPR 60 stainless steel with mast 2CTB899800R7100 + 2CTH070002R0000	Please contact us and ask for leaflet 1TXH000134B0201					

Applications

Commercial building, apartment building

PV String boxes

OVR PV 40-600 P
2CTB803953R5300

External lightning protection

OPR 30 + mast 2M30
2CTB899800R7000 +
2CTH070002R0000

Automatic exchange protection

OVR TC 48 V P
2CTB804820R0300

Sub-distribution board

OVR PLUS N3 40
2CTB803701R0300

Telephone protection

OVR TC 200FR P
2CTB804820R0500

Interphone protection







OVR TC 24 V P
2CTB804820R0200

Main-distribution board

OVR T1 3N 25-255 TS
2CTB815101R0700

5

Equipment protection in commercial market

	Description	Impulse current $I_{imp} (10/350)$	Follow current I_{fi}	Max. discharge current $I_{max} (8/20)$	C2 nominal discharge current I_n	Nominal voltage U_n	Protection level U_p
	OVR TC 24V P 2CTB804820R0200	–	–	10 kA	5 kA	24 V	35 V
	OVR TC 48V P 2CTB804820R0300	–	–	10 kA	5 kA	48 V	70 V
	OVR T1 3N 25-255 TS 2CTB815101R0700	25 kA	50 kA	–	25 kA	230 V	2.5 kV
	OVR PLUS N3 40 2CTB803701R0300	–	–	40 kA	20 kA	230 V	1.6 kV
	OVR PV 40-600 P 2CTB803953R5300	–	–	40 kA	20 kA	670 V	1.6 kV
	OPR 30 stainless steel with mast 2CTB899800R7000 + 2CTH070002R0000	Please contact us and ask for leaflet 1TXH000134B0201					

Applications Residential

5



Distribution board

OVR PLUS N1 40
2CTB803701R0100

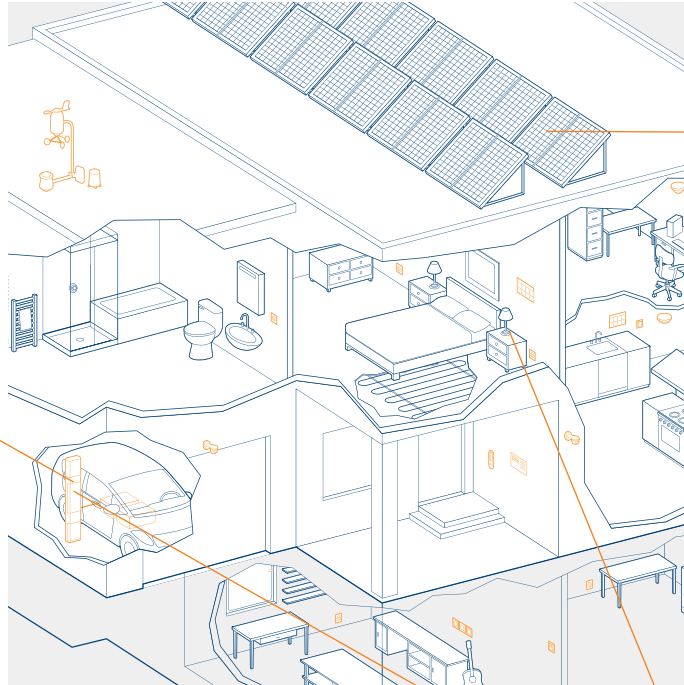

PV String boxes



OVR PV 40-600 P
2CTB803953R5300



Telephone protection

OVR TC 200FR P
2CTB804820R0500

Equipment protection in the residential market

	Description	Max. discharge current $I_{max} (8/20)$	C2 nominal discharge current I_n	Nominal voltage U_n	Protection level U_p
	OVR TC 200FR P 2CTB804820R0500	10 kA	5 kA	200 V	400 V
	OVR PLUS N1 40 2CTB803701R0100	40 kA	20 kA	230 V	1.5 kV
	OVR PV 40-600 P 2CTB803953R5300	40 kA	20 kA	670 V	1.4 kV

Technical definitions

SPD terminology: Surge Protective Device

Device designed to limit transient overvoltages and divert lightning current. When they comply with IEC 61643-11, product standards for low-voltage SPDs, they are classified into three main categories (Type I, Type II and Type III).

Type 1 SPD: SPD tested under Class I tests carried out with the impulse discharge current ($I_{imp} - 10/350\mu s$). Surge protective device designed to divert direct lightning surge current for installation at service entrance (LPZ 0A to 1).

Type 2 SPD: SPD tested under Class II tests carried out with nominal current ($I_n - 8/20 \mu s$). Surge protective device designed to limit indirect transient overvoltage from lightning strike or from switching operations mainly for installation in sub-distributions boards (LPZ 1 to 2, ...) when there is not a risk of direct lightning surge current on the installation.

Type 3 SPD: SPD tested under Class III tests carried out with a combined wave ($U_{oc} 1.2/50 - 8/20 \mu s$). Surge protective device designed for fine transient overvoltage protection.

10/350 μs current wave form: Current wave form which simulate the surge current of a direct lightning strike. The rising front time is 10 μs and the time to reach half value is 350 μs . Used in the Class test for Type I SPDs.

8/20 μs current wave form: Current wave form which simulate the surge current of an indirect transient overvoltage. The rising front time is 8 μs and the time to reach half value is 20 μs . Used in the Class test for Type 2 SPDs.

I_{imp} : Impulse discharge current for Class I tests. Peak current value with a 10/350 μs current wave form for Type I SPDs designed to divert lightning surge current.

I_n : Nominal discharge current for Class II tests. Peak current value for SPDs with current wave of 8/20 μs . Used for SPD preconditioning in the Class I tests.

I_{max} : Maximum discharge current value for Type II SPDs with a current wave form 8/20 μs .

U_n : Nominal voltage of the system to be protected.

U_{oc} : Open circuit voltage of the combination wave. Used in Class III tests for Type 3 SPDs.

U_c / MCOV: Maximum continuous operating voltage. It is the maximum r.m.s. voltage value that can be applied to the SPD terminals. This must be chosen according to the nominal voltage of the system.

U_{cpv} : Maximum continuous operating voltage. It is the maximum DC voltage that can be applied to the PV SPD terminals.

U_p : Voltage protection level. Protection level of the SPDs, the U_p is tested at the nominal discharge current (I_n).

U_T : Temporary overvoltage (TOV). Test done to give the maximum voltage that the SPD can withstand during a certain time.

I_L : Rated load current. Maximum continuous r.m.s. current that can be permanently conducted through a device. Only relevant for SPDs in serial connection.

I_{PE} : Residual current. This value gives the current measured at the PE terminals when the SPD is connected under nominal voltage.

I_P : Prospective short-circuit current of the power supply at the SPD location.

I_{scrr} : Short circuit current rating. Maximum prospective short circuit-current from the power system for which the SPD is configured in conjunction with the recommended back-up protection.

I_{fi} : Follow current interrupting rating. Prospective short-circuit current that an SPD (using gas-tube or spark-gap technology) is able to cut without the use of a back-up disconnector.

N_g : Lightning flash density usually given per square km and per year.

LPS: Lightning Protection System. Complete system used to protect damages due to lightning and transient overvoltages.

LPL: Lightning Protection Level. From I to IV, it is used to define the lightning and transient surges protection measures. For each LPL, a surge current value is given to enable lightning and surge protection calculation:
LPL I => Peak level 200 kA
LPL II => Peak level 150 kA
LPL III and IV => Peak level 100 kA

Norms and standards

Product standards

IEC 61643-11 Refers to surge protective devices (SPDs) connected to low voltage power systems. The scope of this standard is to define a test method for SPDs with the aim to protect direct and indirect effects of lightning or other transient overvoltages. It defines three classes of tests:

The Class I test, simulates partial conducted lightning current impulses (Iimp with 10/350 μ s current impulse) for surge protection for high exposed locations, e.g. line entrances to building protected by a lightning protection system (LPS). The Class II and III tests method are subjected to impulses of shorter duration (respectively, In with 8/20 μ s current impulse and Uoc with combined waves).

IEC 61643-21 Refers to SPDs connected to telecommunication and signalling networks. The surge protective devices are tested with specific waveforms which depend on the categories type chosen from A1 (slow rate of rise) to B, C and D (high energy).

UL 1449 3rd edition The North American ANSI/UL standard covers SPDs designed for limiting transient voltages on 50-60 Hz power circuits not exceeding 1,000 V. It defines 5 types categories based on installation location within an electrical system. While Type 1, Type 2 and Type 3 categories refer to different types of SPDs that can be installed at specific locations, Type 4 and Type 5 categories refer to components used in an SPDs configuration.

UTE C 61-740-51 Refers to SPDs connected to photovoltaic generators. It introduces the idea of testing the behaviour of photovoltaic surge protective devices on end of life for the safety of the equipments and defines specific characteristics to be given for PV SPDs (Ucpv, Iscwpv).

prEN 50539-11 Also refers to surge protective devices connected to photovoltaic generators.

NF C17-102-2011 Refers to Early Streamer Emission Air Terminal (ESEAT) which protect facilities and open areas against direct lightning impact. It is characterized by a better efficiency (Δt) and a higher radius of protection (R_p) compared to a conventional simple rod lightning protection.

Installation standards

IEC 61643-12 Selection and application principles for SPDs connected to low voltage power systems. This standard gives information to evaluate, in according with IEC 62305 Parts 1 to 4, the need for using SPDs in low voltage systems and provides information about the characteristics useful for their selection.

IEC 61643-22 It describes the principles for the selection, application, location and coordination of SPDs connected to telecommunication and signalling networks.

IEC 62305 is compiled in four parts and takes account of varied aspects of the structure and its contents to offer a complete lightning and surge protection to the structure and electrical equipments.

IEC 62305-1 Provides the general principles to be followed in the protection against lightning of on a structure, including their installations and contents as well as persons or, and services connected to a structure.

IEC 62305-2 Is applicable to risk assessment for a structure or for a service to due to lightning flashes. It provides a procedure for the evaluation of such a risk.

IEC 62305-3 Deals with the protection, in and around a structure, and against physical damage.

IEC 62305-4 Provides surge protection information for electrical and electronic system within structure.

IEC 61400-24 Provide information on lightning protection of wind turbine generators and wind power systems. It defines requirements for the protection of blades, other structural components and electrical and control systems against direct and indirect effects of lightning.

EN 50539-12 Selection and application principles to SPDs connected to photovoltaic generators.

Notes

Dotted lines for writing notes.

Index

Order code classification

Order code	Type	Page	Order code	Type	Page	Order code	Type	Page
2CTB235401R0000	OVR WT 3L 690	66	2CTB803854R1400	OVR T2 15-75 C	78	2CTB804601R1500	OVR T2 4L 40-275 (x5)	76
2CTB235402R0000	OVR WT 3L 690 P TS	66	2CTB803919R0200	OVR T2 4L 70-275s P	50	2CTB804820R0000	OVR TC 06V P	68
2CTB803701R0100	OVR PLUS N1 40	62	2CTB803919R0400	OVR T2 4L 70-275s P TS	50	2CTB804820R0100	OVR TC 12V P	68
2CTB803701R0300	OVR PLUS N3 40	62	2CTB803950R0000	OVR PV 40-600 C	79	2CTB804820R0200	OVR TC 24V P	68
2CTB803701R0400	OVR PLUS N3 20	62	2CTB803950R0100	OVR PV 40-1000 C	79	2CTB804820R0300	OVR TC 48V P	68
2CTB803701R0700	OVR PLUS N1 20	62	2CTB803950R0300	OVR PV MC	79	2CTB804820R0400	OVR TC 200V P	68
2CTB803851R0100	OVR T2 70-440s P TS	44	2CTB803950R1000	OVR PV T1 6.25-600 C	79	2CTB804820R0500	OVR TC 200FR P	68
2CTB803851R0200	OVR T2 40-440s P TS	44	2CTB803950R1100	OVR PV T1 6.25-1000 C	79	2CTB804821R0000	OVR TC 06V C	79
2CTB803851R0500	OVR T2 40-440 P TS	44	2CTB803951R1300	OVR T2 120-440s P TS	44	2CTB804821R0100	OVR TC 12V C	79
2CTB803851R0700	OVR T2 70-440s P	44	2CTB803952R0100	OVR T2 1N 70-275s P TS	54	2CTB804821R0200	OVR TC 24V C	79
2CTB803851R0800	OVR T2 40-440s P	44	2CTB803952R0200	OVR T2 1N 40-275s P TS	54	2CTB804821R0300	OVR TC 48V C	79
2CTB803851R1100	OVR T2 15-440 P	44	2CTB803952R0500	OVR T2 1N 40-275 P TS	54	2CTB804821R0400	OVR TC 200V C	79
2CTB803851R1200	OVR T2 40-440 P	44	2CTB803952R0700	OVR T2 1N 70-275s P	54	2CTB804840R1000	BASE OVR TC RJ11	68
2CTB803851R1300	OVR T2 70-275s P TS	42	2CTB803952R0800	OVR T2 1N 40-275s P	54	2CTB804840R1100	BASE OVR TC RJ45	68
2CTB803851R1400	OVR T2 40-275s P TS	42	2CTB803952R1100	OVR T2 1N 40-275 P	54	2CTB813912R1000	OVR 1N 10 275	60
2CTB803851R1700	OVR T2 40-275 P TS	42	2CTB803952R1200	OVR T2 1N 15-275 P	54	2CTB813913R1000	OVR 3N 10 275	60
2CTB803851R1900	OVR T2 70-275s P	42	2CTB803953R0100	OVR T2 3N 70-275s P TS	56	2CTB815101R0100	OVR T1 25-255	22
2CTB803851R2000	OVR T2 40-275s P	42	2CTB803953R0200	OVR T2 3N 40-275s P TS	56	2CTB815101R0300	OVR T1+2 25-255 TS	32
2CTB803851R2300	OVR T2 40-275 P	42	2CTB803953R0500	OVR T2 3N 40-275 P TS	56	2CTB815101R0400	OVR T1 50 N	30
2CTB803851R2400	OVR T2 15-275 P	42	2CTB803953R0700	OVR T2 3N 70-275s P	56	2CTB815101R0500	OVR T1 100 N	30
2CTB803851R2700	OVR T2 15-75 P TS	38	2CTB803953R0800	OVR T2 3N 40-275s P	56	2CTB815101R0600	OVR T1 3L 25-255 TS	24
2CTB803851R2800	OVR T2 15-75 P	38	2CTB803953R1100	OVR T2 3N 40-275 P	56	2CTB815101R0700	OVR T1 3N 25-255 TS	28
2CTB803852R1600	OVR T2 2L 15-75 P TS	38	2CTB803953R1200	OVR T2 3N 15-275 P	56	2CTB815101R0800	OVR T1 4L 25-255 TS	28
2CTB803852R1700	OVR T2 2L 15-75 P	38	2CTB803953R1300	OVR T2 3N 15-440 P	58	2CTB815101R1000	OVR T1 1N 25-255 TS	26
2CTB803853R2200	OVR T2 3L 40-275s P	46	2CTB803953R1400	OVR T2 3N 40-440 P	58	2CTB815101R1100	OVR T1 2L 25-255 TS	22
2CTB803853R2300	OVR T2 3L 40-275s P TS	46	2CTB803953R1500	OVR T2 3N 40-440 P TS	58	2CTB815101R1200	OVR T1 2L 25-255	22
2CTB803853R2400	OVR T2 3L 40-275 P	46	2CTB803953R1600	OVR T2 3N 40-440s P TS	58	2CTB815101R1300	OVR T1 3L 25-255	24
2CTB803853R2500	OVR T2 3L 40-275 P TS	46	2CTB803953R1700	OVR T2 3N 70-440s P	58	2CTB815101R1400	OVR T1 4L 25-255	28
2CTB803853R2600	OVR T2 3L 40-440 P	48	2CTB803953R1800	OVR T2 3N 70-440s P TS	58	2CTB815101R1500	OVR T1 1N 25-255	26
2CTB803853R2700	OVR T2 3L 40-440 P TS	48	2CTB803953R1900	OVR T2 70 N P	42	2CTB815101R1600	OVR T1 3N 25-255	28
2CTB803853R3400	OVR T2 3L 15-275 P	46	2CTB803953R5300	OVR PV 40-600 P	64	2CTB815101R3800	OVR T1+2 7-275s C	76
2CTB803853R4100	OVR T2 3L 70-275s P	46	2CTB803953R5400	OVR PV 40-600 P TS	64	2CTB815101R3900	OVR T1+2 7-275s P	32
2CTB803853R4200	OVR T2 3L 70-440s P	48	2CTB803953R5700	OVR PV T1 6.25-600 P TS	64	2CTB815101R4000	OVR T1+2 3L 7-275s P	34
2CTB803853R4300	OVR T2 3L 70-440s P TS	48	2CTB803953R6400	OVR PV 40-1000 P	64	2CTB815101R4100	OVR T1+2 4L 7-275s P	36
2CTB803853R4400	OVR T2 3L 70-275s P TS	46	2CTB803953R6500	OVR PV 40-1000 P TS	64	2CTB815101R5100	OVR T1+2 70 NC	76
2CTB803853R4500	OVR T2 3L 40-440/690 P	48	2CTB803953R6700	OVR PV T1 6.25-1000 P TS	64	2CTB815101R8700	OVR T1 25-255-7	22
2CTB803853R4600	OVR T2 3L 40-440/690 P TS	48	2CTB804200R0100	OVR T2 20-275	40	2CTB815101R8800	OVR T1 3N 25-255-7	28
2CTB803853R5000	OVR T2 4L 40-275s P TS	50	2CTB804200R0200	OVR T2 20-440	44	2CTB815101R8900	OVR T1+2 15-255-7	32
2CTB803853R5100	OVR T2 4L 40-440 P	52	2CTB804200R0700	OVR T2 20-150	40	2CTB815101R9000	OVR T1+2 3N 15-255-7	36
2CTB803853R5200	OVR T2 4L 40-275 P TS	50	2CTB804200R1100	OVR T2 20-275 (x20)	76	2CTB815101R9300	OVR T1 25-440-50	22
2CTB803853R5300	OVR T2 4L 40-440 P TS	52	2CTB804200R1200	OVR T2 20-440 (x20)	76	2CTB815101R9700	OVR T1 25 N	30
2CTB803853R5400	OVR T2 4L 40-275s P	50	2CTB804200R1700	OVR T2 20-150 (x20)	76	2CTB815201R0800	OVR HL 15-440s P TS	32
2CTB803853R5600	OVR T2 4L 40-275 P	50	2CTB804201R0100	OVR T2 40-275	40	2CTB815250R0300	OVR HL 15-440s C	76
2CTB803853R6000	OVR T2 4L 15-275 P	50	2CTB804201R0200	OVR T2 40-440	44	2CTB815302R1000	OVR T1+2 1N 7-275s P	36
2CTB803853R7000	OVR T2 4L 70-440s P	52	2CTB804201R0700	OVR T2 40-150	40	2CTB815303R0400	OVR HL 2L 15-440s P TS	76
2CTB803853R7100	OVR T2 4L 70-440s P TS	52	2CTB804201R1100	OVR T2 40-275 (x20)	76	2CTB815401R0400	OVR HL 3L 15-440s P TS	34
2CTB803854R0000	OVR T2 70 N C	78	2CTB804201R1200	OVR T2 40-440 (x20)	76	2CTB815502R1000	OVR T1+2 3N 7-275s P	36
2CTB803854R0100	OVR T2 70-440s C	78	2CTB804201R1700	OVR T2 40-150 (x20)	76	2CTB815503R0400	OVR HL 4L 15-440s P TS	36
2CTB803854R0300	OVR T2 40-440s C	78	2CTB804600R0400	OVR T2 3L 20-275	46	2CTB899800R7000	OPR 30	74
2CTB803854R0400	OVR T2 40-440 C	78	2CTB804600R0500	OVR T2 4L 20-275	50	2CTB899800R7100	OPR 60	74
2CTB803854R0600	OVR T2 15-440 C	78	2CTB804600R1400	OVR T2 3L 20-275 (x6)	76	2CTH070002R0000	Mast 2M30	74
2CTB803854R0700	OVR T2 70-275s C	78	2CTB804600R1500	OVR T2 4L 20-275 (x5)	76			
2CTB803854R0900	OVR T2 40-275s C	78	2CTB804601R0400	OVR T2 3L 40-275	46			
2CTB803854R1000	OVR T2 40-275 C	78	2CTB804601R0500	OVR T2 4L 40-275	50			
2CTB803854R1200	OVR T2 15-275 C	78	2CTB804601R1400	OVR T2 3L 40-275 (x6)	76			

Index

Type classification

Type	Order code	Page	Type	Order code	Page	Type	Order code	Page
BASE OVR TC RJ11	2CTB804840R1000	68	OVR T2 15-275 C	2CTB803854R1200	78	OVR T2 40-275 (x20)	2CTB804201R1100	76
BASE OVR TC RJ45	2CTB804840R1100	68	OVR T2 15-275 P	2CTB803851R2400	42	OVR T2 40-275 C	2CTB803854R1000	78
Mast 2M30	2CTH070002R0000	74	OVR T2 15-440 C	2CTB803854R0600	78	OVR T2 40-275 P	2CTB803851R2300	42
OPR 30	2CTB899800R7000	74	OVR T2 15-440 P	2CTB803851R1100	44	OVR T2 40-275 P TS	2CTB803851R1700	42
OPR 60	2CTB899800R7100	74	OVR T2 15-75 C	2CTB803854R1400	78	OVR T2 40-275s C	2CTB803854R0900	78
OVR 1N 10 275	2CTB813912R1000	60	OVR T2 15-75 P	2CTB803851R2800	38	OVR T2 40-275s P	2CTB803851R2000	42
OVR 3N 10 275	2CTB813913R1000	60	OVR T2 15-75 P TS	2CTB803851R2700	38	OVR T2 40-275s P TS	2CTB803851R1400	42
OVR HL 15-440s C	2CTB815250R0300	76	OVR T2 1N 15-275 P	2CTB803952R1200	54	OVR T2 40-440	2CTB804201R0200	44
OVR HL 15-440s P TS	2CTB815201R0800	32	OVR T2 1N 40-275 P	2CTB803952R1100	54	OVR T2 40-440 (x20)	2CTB804201R1200	76
OVR HL 2L 15-440s P TS	2CTB815303R0400	76	OVR T2 1N 40-275 P TS	2CTB803952R0500	54	OVR T2 40-440 C	2CTB803854R0400	78
OVR HL 3L 15-440s P TS	2CTB815401R0400	34	OVR T2 1N 40-275s P	2CTB803952R0800	54	OVR T2 40-440 P	2CTB803851R1200	44
OVR HL 4L 15-440s P TS	2CTB815503R0400	36	OVR T2 1N 40-275s P TS	2CTB803952R0200	54	OVR T2 40-440 P TS	2CTB803851R0500	44
OVR PLUS N1 20	2CTB803701R0700	62	OVR T2 1N 70-275s P	2CTB803952R0700	54	OVR T2 40-440s C	2CTB803854R0300	78
OVR PLUS N1 40	2CTB803701R0100	62	OVR T2 1N 70-275s P TS	2CTB803952R0100	54	OVR T2 40-440s P	2CTB803851R0800	44
OVR PLUS N3 20	2CTB803701R0400	62	OVR T2 20-150	2CTB804200R0700	40	OVR T2 40-440s P TS	2CTB803851R0200	44
OVR PLUS N3 40	2CTB803701R0300	62	OVR T2 20-150 (x20)	2CTB804200R1700	76	OVR T2 4L 15-275 P	2CTB803853R6000	50
OVR PV 40-1000 C	2CTB803950R0100	79	OVR T2 20-275	2CTB804200R0100	40	OVR T2 4L 20-275	2CTB804600R0500	50
OVR PV 40-1000 P	2CTB803953R6400	64	OVR T2 20-275 (x20)	2CTB804200R1100	76	OVR T2 4L 20-275 (x5)	2CTB804600R1500	76
OVR PV 40-1000 P TS	2CTB803953R6500	64	OVR T2 20-440	2CTB804200R0200	44	OVR T2 4L 40-275	2CTB804601R0500	50
OVR PV 40-600 C	2CTB803950R0000	79	OVR T2 20-440 (x20)	2CTB804200R1200	76	OVR T2 4L 40-275 (x5)	2CTB804601R1500	76
OVR PV 40-600 P	2CTB803953R5300	64	OVR T2 2L 15-75 P	2CTB803852R1700	38	OVR T2 4L 40-275 P	2CTB803853R5600	50
OVR PV 40-600 P TS	2CTB803953R5400	64	OVR T2 2L 15-75 P TS	2CTB803852R1600	38	OVR T2 4L 40-275 P TS	2CTB803853R5200	50
OVR PV MC	2CTB803950R0300	79	OVR T2 3L 15-275 P	2CTB803853R3400	46	OVR T2 4L 40-275s P	2CTB803853R5400	50
OVR PV T1 6.25-1000 C	2CTB803950R1100	79	OVR T2 3L 20-275	2CTB804600R0400	46	OVR T2 4L 40-275s P TS	2CTB803853R5000	50
OVR PV T1 6.25-1000 P TS	2CTB803953R6700	64	OVR T2 3L 20-275 (x6)	2CTB804600R1400	76	OVR T2 4L 40-440 P	2CTB803853R5100	52
OVR PV T1 6.25-600 C	2CTB803950R1000	79	OVR T2 3L 40-275	2CTB804601R0400	46	OVR T2 4L 40-440 P TS	2CTB803853R5300	52
OVR PV T1 6.25-600 P TS	2CTB803953R5700	64	OVR T2 3L 40-275 (x6)	2CTB804601R1400	76	OVR T2 4L 70-275s P	2CTB803919R0200	50
OVR T1 100 N	2CTB815101R0500	30	OVR T2 3L 40-275 P	2CTB803853R2400	46	OVR T2 4L 70-275s P TS	2CTB803919R0400	50
OVR T1 1N 25-255	2CTB815101R1500	26	OVR T2 3L 40-275 P TS	2CTB803853R2500	46	OVR T2 4L 70-440s P	2CTB803853R7000	52
OVR T1 1N 25-255 TS	2CTB815101R1000	26	OVR T2 3L 40-275s P	2CTB803853R2200	46	OVR T2 4L 70-440s P TS	2CTB803853R7100	52
OVR T1 25 N	2CTB815101R9700	30	OVR T2 3L 40-275s P TS	2CTB803853R2300	46	OVR T2 70 N C	2CTB803854R0000	78
OVR T1 25-255	2CTB815101R0100	22	OVR T2 3L 40-440 P	2CTB803853R2600	48	OVR T2 70 N P	2CTB803953R1900	42
OVR T1 25-255-7	2CTB815101R8700	22	OVR T2 3L 40-440 P TS	2CTB803853R2700	48	OVR T2 70-275s C	2CTB803854R0700	78
OVR T1 25-440-50	2CTB815101R9300	22	OVR T2 3L 40-440/690 P	2CTB803853R4500	48	OVR T2 70-275s P	2CTB803851R1900	42
OVR T1 2L 25-255	2CTB815101R1200	22	OVR T2 3L 40-440/690 P TS	2CTB803853R4600	48	OVR T2 70-275s P TS	2CTB803851R1300	42
OVR T1 2L 25-255 TS	2CTB815101R1100	22	OVR T2 3L 70-275s P	2CTB803853R4100	46	OVR T2 70-440s C	2CTB803854R0100	78
OVR T1 3L 25-255	2CTB815101R1300	24	OVR T2 3L 70-275s P TS	2CTB803853R4400	46	OVR T2 70-440s P	2CTB803851R0700	44
OVR T1 3L 25-255 TS	2CTB815101R0600	24	OVR T2 3L 70-440s P	2CTB803853R4200	48	OVR T2 70-440s P TS	2CTB803851R0100	44
OVR T1 3N 25-255	2CTB815101R1600	28	OVR T2 3L 70-440s P TS	2CTB803853R4300	48	OVR TC 06V C	2CTB804821R0000	79
OVR T1 3N 25-255 TS	2CTB815101R0700	28	OVR T2 3N 15-275 P	2CTB803953R1200	56	OVR TC 06V P	2CTB804820R0000	68
OVR T1 3N 25-255-7	2CTB815101R8800	28	OVR T2 3N 15-440 P	2CTB803953R1300	58	OVR TC 12V C	2CTB804821R0100	79
OVR T1 4L 25-255	2CTB815101R1400	28	OVR T2 3N 40-275 P	2CTB803953R1100	56	OVR TC 12V P	2CTB804820R0100	68
OVR T1 4L 25-255 TS	2CTB815101R0800	28	OVR T2 3N 40-275 P TS	2CTB803953R0500	56	OVR TC 200FR P	2CTB804820R0500	68
OVR T1 50 N	2CTB815101R0400	30	OVR T2 3N 40-275s P	2CTB803953R0800	56	OVR TC 200V C	2CTB804821R0400	79
OVR T1+2 15-255-7	2CTB815101R8900	32	OVR T2 3N 40-275s P TS	2CTB803953R0200	56	OVR TC 200V P	2CTB804820R0400	68
OVR T1+2 1N 7-275s P	2CTB815302R1000	36	OVR T2 3N 40-440 P	2CTB803953R1400	58	OVR TC 24V C	2CTB804821R0200	79
OVR T1+2 25-255 TS	2CTB815101R0300	32	OVR T2 3N 40-440 P TS	2CTB803953R1500	58	OVR TC 24V P	2CTB804820R0200	68
OVR T1+2 3L 7-275s P	2CTB815101R4000	34	OVR T2 3N 40-440s P TS	2CTB803953R1600	58	OVR TC 48V C	2CTB804821R0300	79
OVR T1+2 3N 15-255-7	2CTB815101R9000	36	OVR T2 3N 70-275s P	2CTB803953R0700	56	OVR TC 48V P	2CTB804820R0300	68
OVR T1+2 3N 7-275s P	2CTB815502R1000	36	OVR T2 3N 70-275s P TS	2CTB803953R0100	56	OVR WT 3L 690	2CTB235401R0000	66
OVR T1+2 4L 7-275s P	2CTB815101R4100	36	OVR T2 3N 70-440s P	2CTB803953R1700	58	OVR WT 3L 690 P TS	2CTB235402R0000	66
OVR T1+2 70 NC	2CTB815101R5100	76	OVR T2 3N 70-440s P TS	2CTB803953R1800	58			
OVR T1+2 7-275s C	2CTB815101R3800	76	OVR T2 40-150	2CTB804201R0700	40			
OVR T1+2 7-275s P	2CTB815101R3900	32	OVR T2 40-150 (x20)	2CTB804201R1700	76			
OVR T2 120-440s P TS	2CTB803951R1300	44	OVR T2 40-275	2CTB804201R0100	40			

Marketing tools

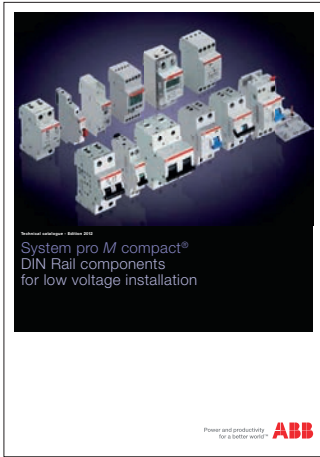

Technical catalogue
System pro M compact®
DIN Rail components for low voltage installation
2CSC 400 002 D0210

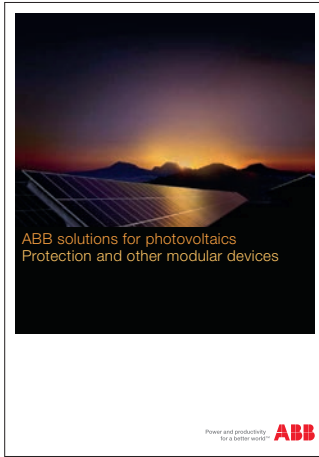

Brochure
ABB solutions for photovoltaics
Protection and other modular devices
2CDC 002 093 B0201

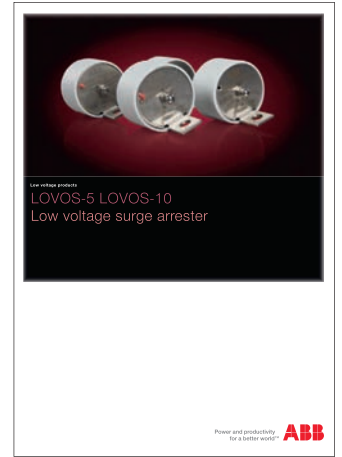

Brochure
LOVOS-5 LOVOS 10
Low voltage surge arresters



Brochure
Surge Protective Devices
OVR DIN rail and NE12 UL range
1TXH 000 168 C0201



Brochure
Autoprotected surge arresters
New OVR PLUS range
1TXH 000 045 B0201

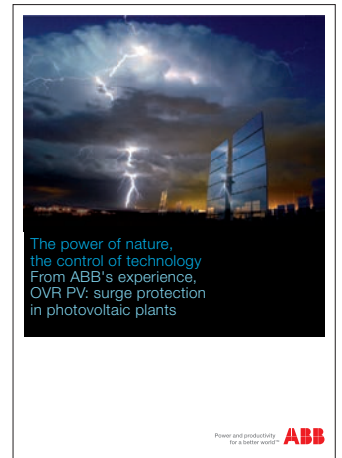

Brochure
The power of nature, the control of technology
OVR PV: surge protection in photovoltaic plants
2CSC 432 012 B0201

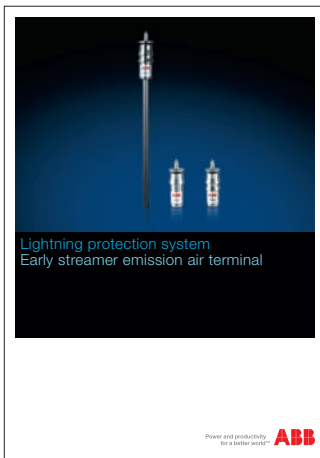

Brochure
Lightning protection system
Early streamer emission air terminal
1TXH 000 134 B0201



Datasheet
Surge protective devices
OVR PV range
1TXH 000 043 L0201



Technical paper, March 2011
Surge protective devices
UL 1449 from 2nd to 3rd Edition
1TXH 000 106 L0201

Contact us

ABB France

Low Voltage Products Division

Pôle Foudre Soulé & Hérita

465, avenue des Pré Seigneurs - La Boisse
F-01124 Montluel cedex / France

www.abb.com

ABB Sp. zo.o.

Branch in Przasnysz

06-300 Przasnysz
ul. Leszno 59 / Poland

www.abb.pl

Note

We reserve the right to make technical changes or modify the contents of this document without prior notice.

ABB does not accept any responsibility whatsoever for potential errors or possible lack of information in this document.

We reserve all rights in this document and in the subject matter and illustrations contained therein. Any reproduction, disclosure to third parties or utilization of its contents – in whole or in parts – is forbidden without prior written consent of ABB.

Copyright© 2012 ABB - All rights reserved