

NOTE



All numerical values are in metric units [with U.S. customary units in brackets]. Dimensions are in millimeters [and inches]. Unless otherwise specified, dimensions have a tolerance of ± 0.13 [$\pm .005$] and angles have a tolerance of $\pm 2^\circ$. Figures and illustrations are for identification only and are not drawn to scale.

1. INTRODUCTION

This specification covers the requirements for application of Next Generation AMP PACE connectors onto printed circuit (pc) boards for use in computer and electronic equipment. The connectors are designed to connect daughter card to motherboard. These connectors contain press-fit compliant pin contacts in 10 through 60 positions. The connectors have a double row of contacts with spacing on 2.54×5.08 mm [$.100 \times .200$ in.] centerlines. The connectors are supplied in soft tray form for manual placement, and hard tray form for automatic machine placement.

The connectors feature a housing with a card slot which accepts 1.37 through 1.78 mm [.054 through .070 in.] thick daughter card. The card slot contains inter-contact keying slots that accept a key plug (available separately) to ensure proper orientation with the mating daughter card (which must be slotted to accept the key). An inter-contact keying slot is located between the contacts. The connectors are also available with a molded-in key (the mating daughter card must be slotted to accept this key).

When corresponding with Tyco Electronics Personnel, use the terminology provided in this specification to facilitate your inquiries for information. Basic terms and features of this product are provided in Figure 1.

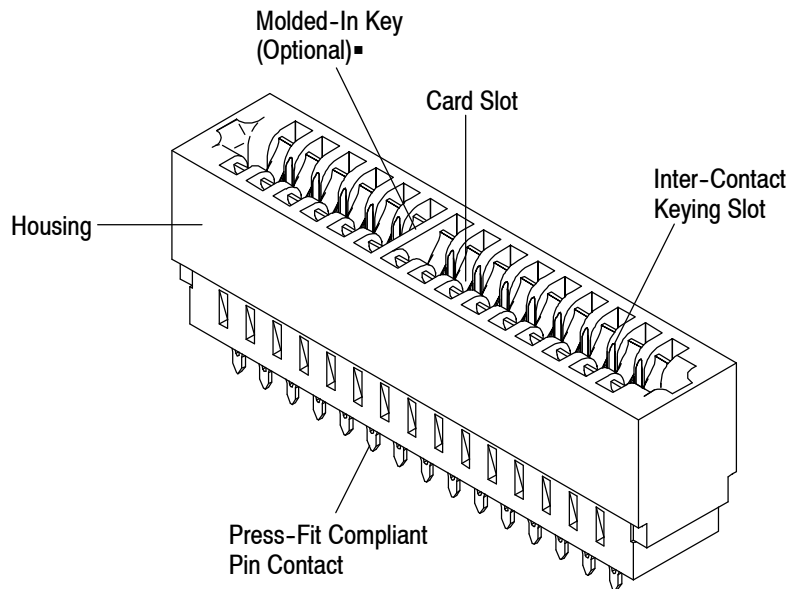

▪ Position Varies According to Connector

Figure 1

2. REFERENCE MATERIAL

2.1. Revision Summary

- Updated document to corporate requirements with new logo and format
- Deleted obsolete documents and tooling in Paragraphs 2.5 and Section 5

2.2. Customer Assistance

Product Part Numbers 147490, 5147490, and Product Code E985 are representative of Next Generation AMP PACE connectors. Use of these numbers will identify the product line and expedite your inquiries through a service network established to help you obtain product and tooling information. Such information can be obtained through a local Tyco Electronics Representative or, after purchase, by calling Product Information at the number at the bottom of page 1.

2.3. Drawings

Customer Drawings for product part numbers are available from the service network. If there is a conflict between the information contained in the Customer Drawings and this specification or with any other technical documentation supplied, call Product Information at the number at the bottom of page 1.

2.4. Specifications

Design Objective 108-14019-1 provides expected product performance and test information.

2.5. Instructional Material

Instruction Sheets (408-series) provide assembly instructions and Customer Manuals (409-series) provide machine setup and operation procedures. Documents available which pertain to this product are:

408-6923 Manual Arbor Frame Assembly 58024-1
408-9027 Adapter Kit for Greenerd Frame Assembly

3. REQUIREMENTS

3.1. Safety

Do not stack component packages so high that the shipping containers buckle or deform.

3.2. Limitations

These connectors are designed to operate in a temperature range of -55° to 85°C [-67° to 185°F].

3.3. Material

The connector housing is made of glass-filled polyester. The contacts are made of phosphor bronze plated with nickel; contact areas are plated with gold, and the tips are plated with tin-lead or matte tin.

3.4. Storage

A. Ultraviolet Light

Prolonged exposure to ultraviolet light may deteriorate the chemical composition used in the connector material.

B. Shelf Life

The connectors should remain in the shipping containers until ready for use to prevent deformation to the contacts. The connectors should be used on a first in, first out basis to avoid storage contamination that could adversely affect performance.

3.5. Chemical Exposure

Do not store connectors near any chemical listed below as they may cause stress corrosion cracking in the contacts.

Alkalies	Ammonia	Citrates	Phosphates	Citrates	Sulfur Compounds
Amines	Carbonates	Nitrites	Sulfur	Nitrites	Tartrates

3.6. PC Board (Motherboard)

A. Material and Thickness

The pc board material shall be glass epoxy (FR-4 or G-10). The pc board thickness range shall be 1.37 through 1.78 mm [.054 through .070 in.].

NOTE



Contact Product Information at the number listed at the bottom of page 1 for suitability of other board materials and thicknesses.

B. Tolerance

Maximum allowable bow of the pc board shall be 0.03 mm [.001 in.] over the length of the connector.

Maximum allowable recycle of the pc board holes shall be three times.

C. Hole Dimensions

The holes in the pc board for the contacts must be drilled and plated through to specific dimensions. The plating type and thickness and finished hole size must be as stated to provide unrestricted insertion. See Figure 2.

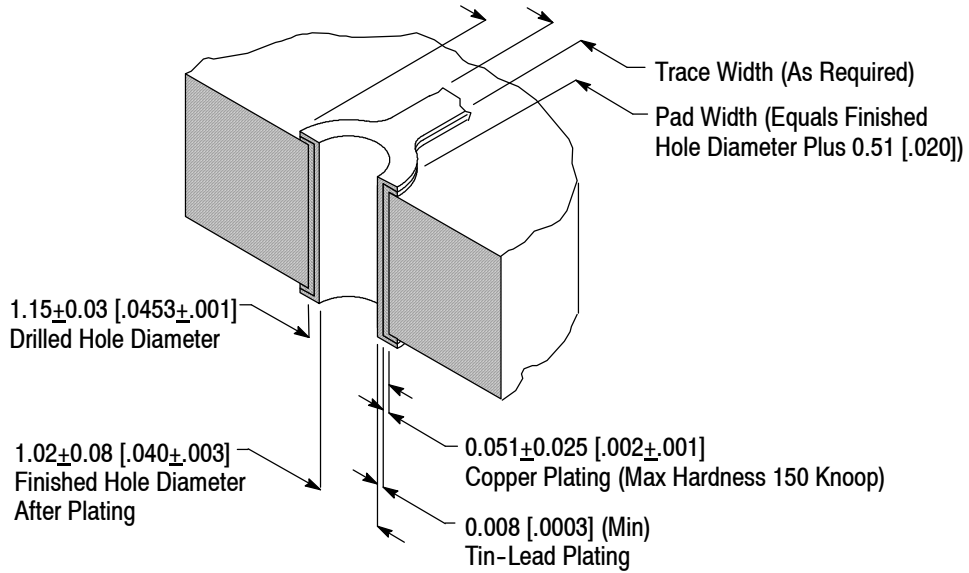
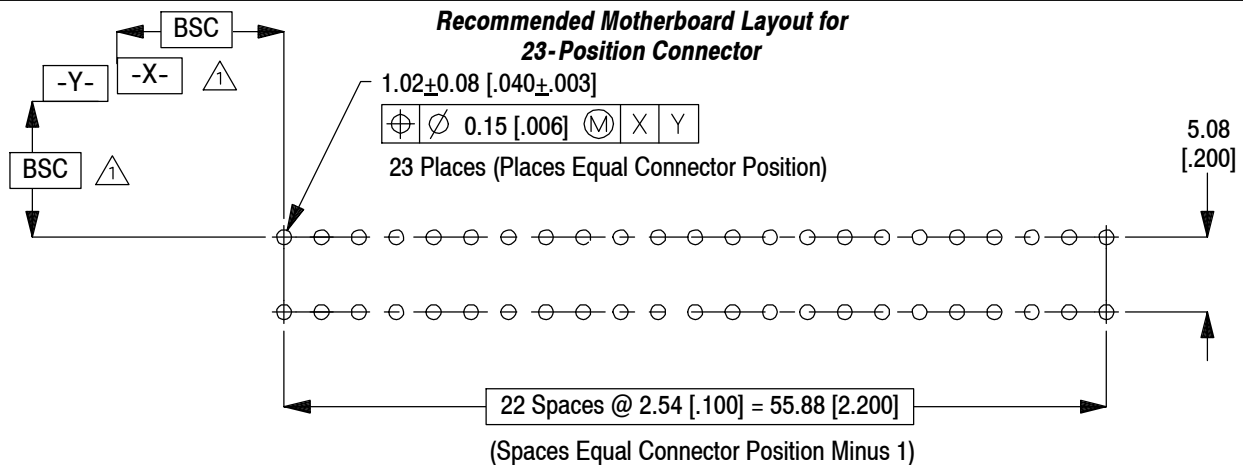

Figure 2

D. Layout

The holes in the pc board must be precisely located to ensure proper placement and optimum performance of the connector. The pc board layout must be designed using the dimensions provided on the customer drawing for the specific connector. A *sample* of the recommended pc board layout is shown in Figure 3.



Datums and Basic Dimensions Established by Customer

Figure 3

3.7. Daughter Card Configuration

The circuit pads of the mating daughter card shall be made of gold. The daughter card thickness range shall be 1.37 through 1.78 mm [.054 through .070 in.].

The mating daughter card configuration must be in accordance with the dimensions and tolerances provided on the customer drawing for the specific connector. A *typical* recommended daughter card configuration is shown in Figure 4.

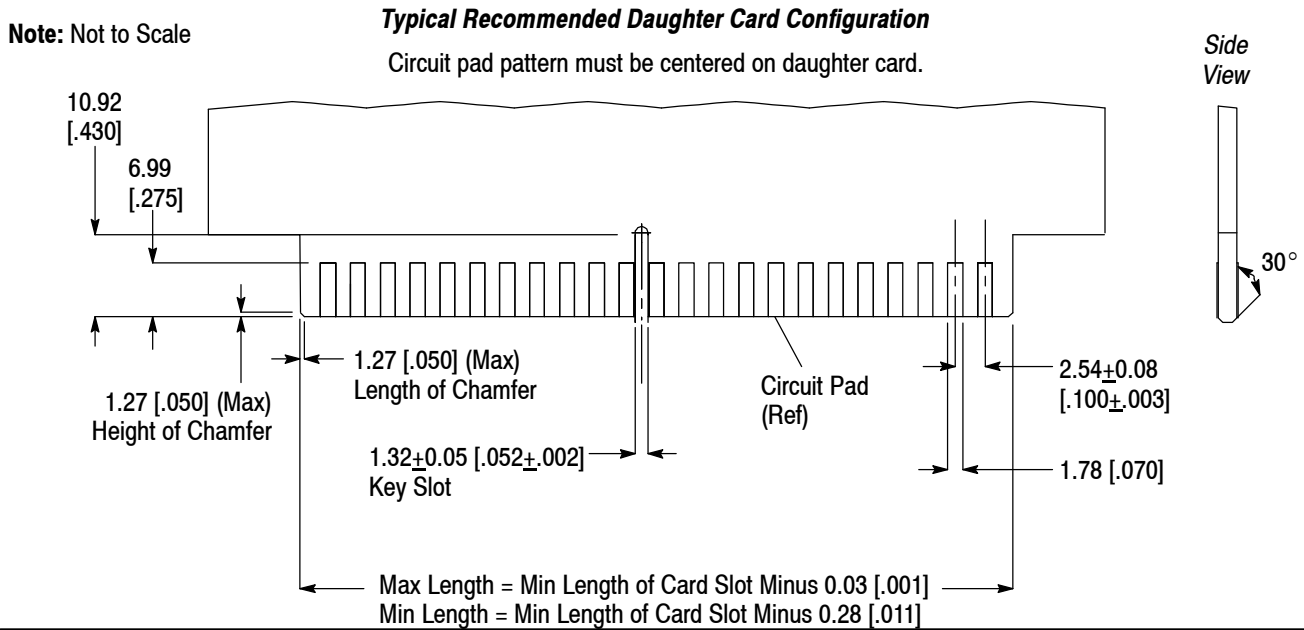

Figure 4

3.8. Connector Spacing

Care must be used to avoid interference between adjacent connectors and other components. The minimum allowable distance between connectors to ensure proper mating is provided in Figure 5.

NOTE This requirement is for manual placement of connectors. If robotic equipment is used, other space allowances will be required for the grippers.

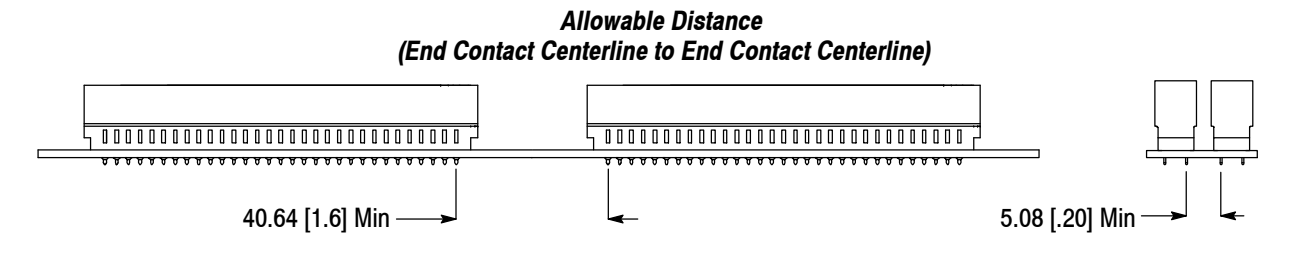

Figure 5

3.9. Connector Placement

CAUTION Connectors should be handled only by the housing to avoid deformation, contamination, or damage to the contacts.

When placing connectors on the pc board, contacts must be aligned and started into the matching holes before seating the connector onto the board. The force required to seat the connector onto the board can be calculated by:

$$\text{Number of connector positions} \times 35.6 \text{ N [8 lb]} \text{ (maximum seating force per contact)} = \text{connector seating force N [lb]}$$

3.10. Polarization

The connectors are available with a polarization feature. These connectors are polarized to the mating daughter card by the molded-in key. The daughter card must be slotted to accept the molded-in key. This prevents the daughter card from being incorrectly inserted into the connector.

3.11. Keying

A key plug is available to insert into any of the inter-contact keying slots in the connector. The daughter card must be slotted to accept the key plug. This prevents the daughter card from being incorrectly inserted into the connector. The key plug must be inserted into the card slot with the flat end facing up, then fully seated. Keying can be done before or after the connector is installed onto the pc board. See Figure 6.

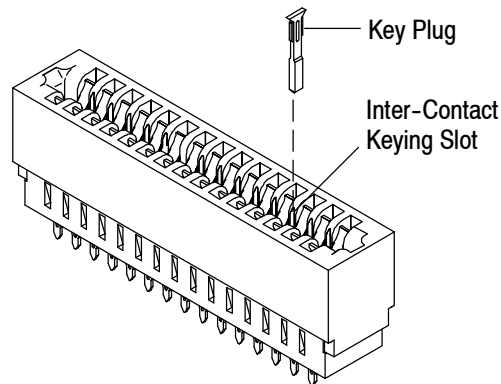

Figure 6

3.12. Checking Installed Connector

The widest section of each contact must be inside the pc board hole. The housing must be seated on the pc board not exceeding the dimension shown in Figure 7.

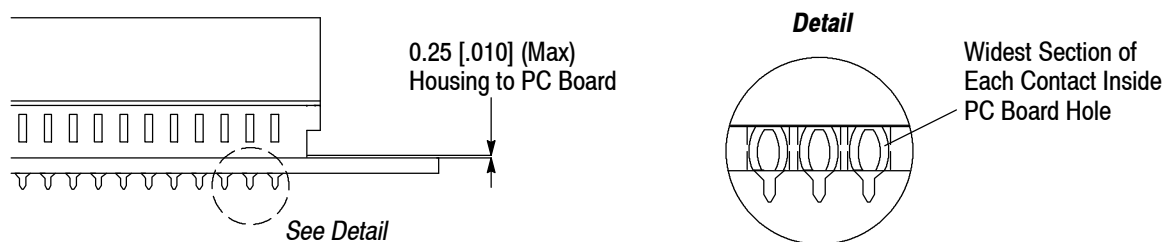

Figure 7

3.13. Daughter Card Mating and Unmating



When mating or unmating the daughter card, care should be taken to prevent longitudinal rocking of the daughter card with respect to the connector. Angles greater than 3° could cause damage to the housing or misregistration of the contacts and daughter card circuit pads.

The daughter card must be mated to the connector according to the following.

1. For connectors with a key plug, the keying slot of the daughter card must be aligned with the key plug. For connectors with a molded-in key, the keying slot of the daughter card must be aligned with the molded-in key. Refer to Figure 8, Detail A.
2. The daughter card must be inserted straight into the connector card slot until the card is fully seated. See Figure 8, Detail B.

When being removed from the connector, the daughter card must be carefully pulled straight out of the connector card slot.

3.14. Connector Removal

The force required to remove the connector from the pc board can be calculated by:

$$\text{Number of connector positions} \times 8.9 \text{ N [2 lb]} \text{ (minimum extraction force per contact)} = \text{connector extraction force N [lb]}$$

3.15. Repair

These connectors are not repairable. Damaged connectors must be removed, discarded, and replaced with new ones. Connectors must be removed from the pc board using a push bar (or flat rock) covering all contacts protruding through the board. A housing support and pc board support must also be used during removal.

4. QUALIFICATION

No qualifying support for Next Generation AMP PACE connectors was defined at the time of publication of this document.

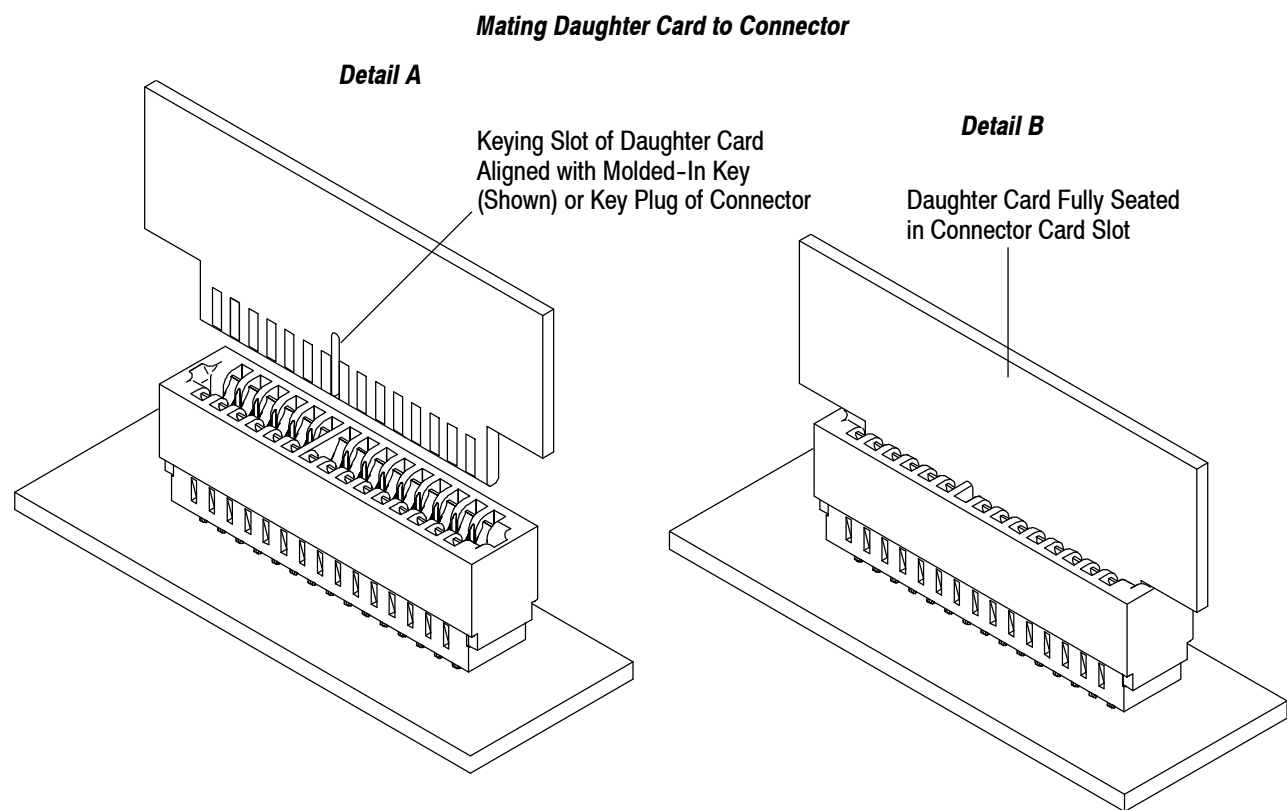

5. TOOLING

No tooling is required for manual placement of the connectors onto the pc board. Manually-operated tools are available. The application tooling must provide sufficient amount of downward force to insert the contacts into the pc board holes. Tooling part numbers and instructional material packaged with the tooling are shown in Figure 9.

5.1. Manual Tools

For low-volume production, commercial hand-operated arbor presses are available. For seating the connectors, the Greenerd manual frame assembly must be fitted with an adapter kit. The adapter kit includes a board support plate.

5.2. Robotic Equipment

Robotic equipment must have a true position accuracy tolerance of 0.25 mm [.010 in.] to feed, pick up, and place the connectors on the pc board. This includes gripper and fixture tolerances as well as equipment repeatability.

5.3. Housing Support

A housing support with sides and ends as close as possible to the connector housing is recommended when removing the connectors from the pc board. The support protects the housing from damage.

5.4. PC Board Support

For machine placement, a pc board support must be used to prevent bowing of the pc board during the placement of connectors on the board. The support should have flat surfaces with holes or a channel large enough and deep enough to receive the contacts. It is also recommended using the pc board support when removing connectors from the board.

5.5. Push Bar (Flat Rock)

Commercially available bar stock with a flat surface large enough to cover all contacts is used to seat connectors and must be used with application tooling. The push bar is also used to remove connectors from the pc board.

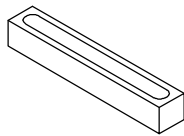

Housing Support
(Customer Supplied)

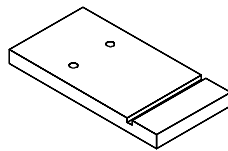

PC Board Support
(Customer Supplied)

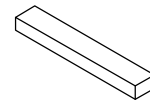

Push Bar (Flat Rock)
(Customer Supplied)

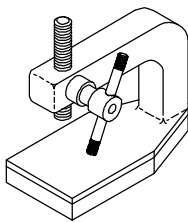

Greenerd 3A or 3B Manual
Frame Assembly (Commercially
Available) Used with Adapter Kit
(Refer to 408-9027)

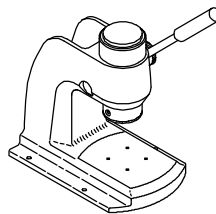

Manual Arbor Frame
Assembly 58024-1
(408-6923)

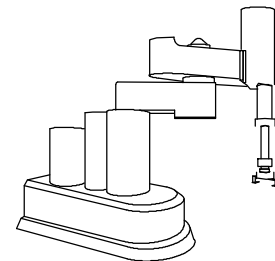

Robotic Equipment

Figure 9

6. VISUAL AID

Figure 10 shows a typical application of Next Generation AMP PACE connectors. This illustration should be used by production personnel to ensure a correctly applied product. Applications which DO NOT appear correct should be inspected using the information in the preceding pages of this specification and in the instructional material shipped with the product or tooling.

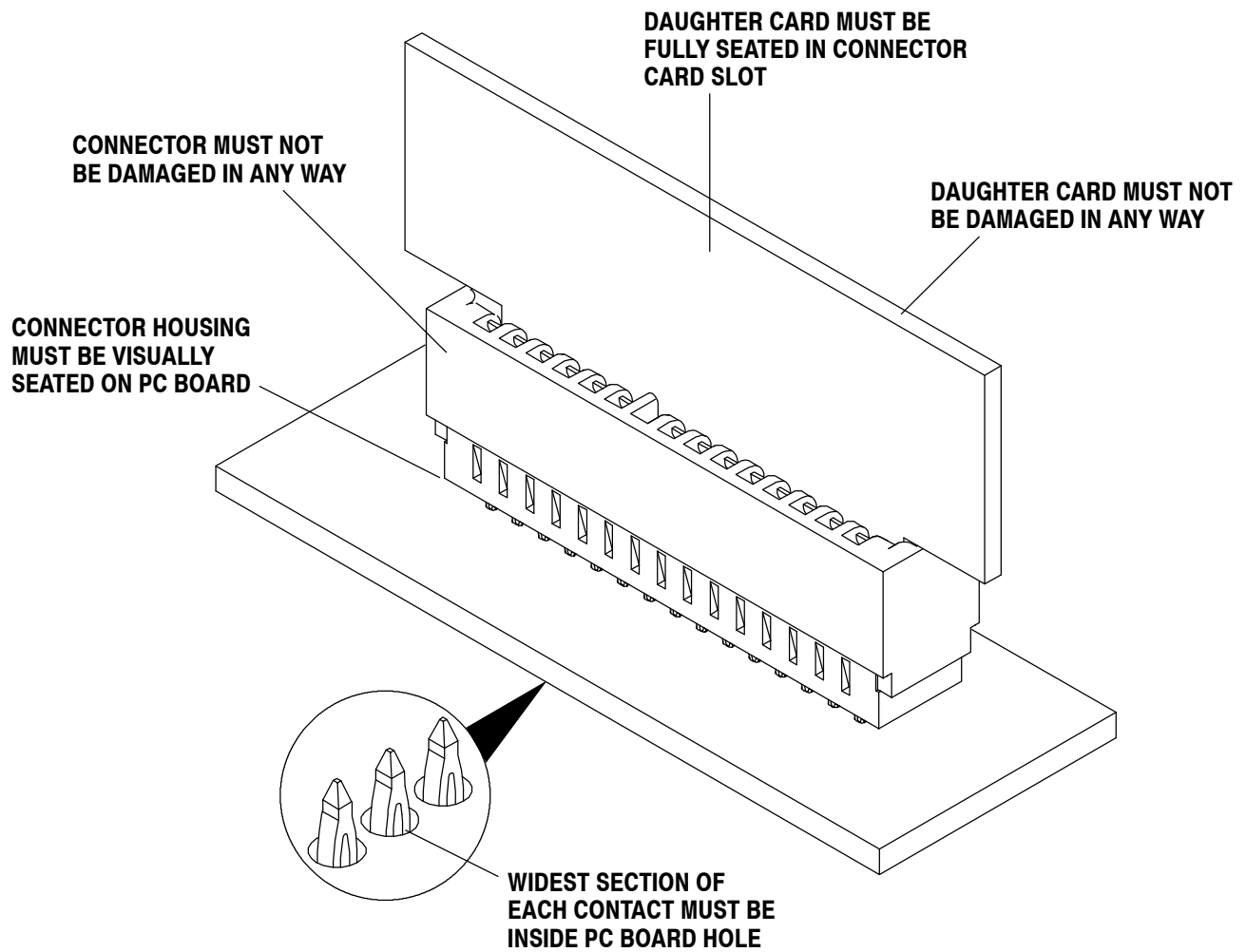

FIGURE 10. VISUAL AID