



FEATURES

- RoHS compliant
- Inductance range from 1.2μH to 220μH
- Small footprint
- Ultra-low profile
- UL 94V-0 packaging materials
- Tape & reel
- J-STD-020C reflow
- Custom inductance values available

PRODUCT OVERVIEW

The 3400L series is a lower profile version of our 3400 series range of bobbin-wound, shielded inductors. They are suitable for power-line filtering found in consumer electronics such as desktop computers, handheld devices and GPS systems, as well as in a vast range of industrial and telecom applications including network hubs, bridges/routers, and high frequency wireless communication devices.

These surface mount inductors are extremely compact and have an integral shield, making them useful in EMI sensitive applications.

SELECTION GUIDE

Order Code	Inductance, L	DC Current ²	DC Resistance
	±20% μH	Max. A	Max. Ω
34L122C	1.2 ± 30%	1.70	0.075
34L152C	1.5 ± 30%	1.65	0.085
34L222C	2.2 ± 30%	1.35	0.100
34L332C	3.3 ± 30%	1.00	0.150
34L472C	4.7 ± 30%	0.70	0.180
34L682C	6.8 ± 30%	0.68	0.265
34L103C	10	0.66	0.325
34L153C	15	0.65	0.520
34L223C	22	0.48	0.780
34L333C	33	0.36	1.180
34L473C	47	0.31	1.820
34L683C	68	0.28	2.130
34L104C	100	0.24	3.330
34L154C	150	0.18	6.100
34L224C	220	0.16	8.000

ABSOLUTE MAXIMUM RATINGS

Operating temperature range	-40°C to 125°C
Storage temperature range	-40°C to 150°C

SOLDERING INFORMATION¹

Peak reflow solder temperature	260°C
Pin finish	SAC 305
Moisture sensitivity level ³	1

PACKAGE SPECIFICATIONS

Mechanical Dimensions

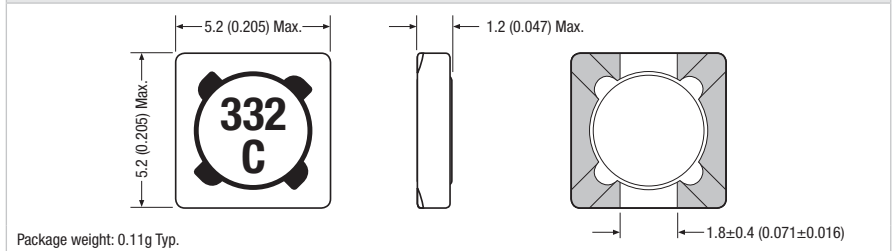

Recommended Footprint Details

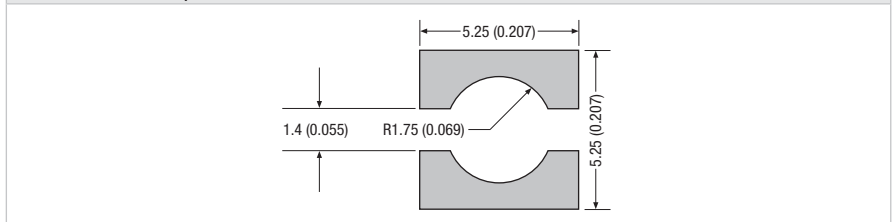

All dimensions in mm (inches)

Specifications typical at $T_a = 25^\circ\text{C}$

1 For further information, please visit www.murata-ps.com/rohs

2 The maximum DC current is the value at which the inductance falls to 75% of its nominal value or when its temperature rise reaches 40°C, whichever is sooner.

3 When tested to moisture sensitivity level 1, as described per IPC/JEDEC J-STD-020D, products passed electrical testing, package coplanarity and visual inspection.



INDUCTANCE Vs CURRENT

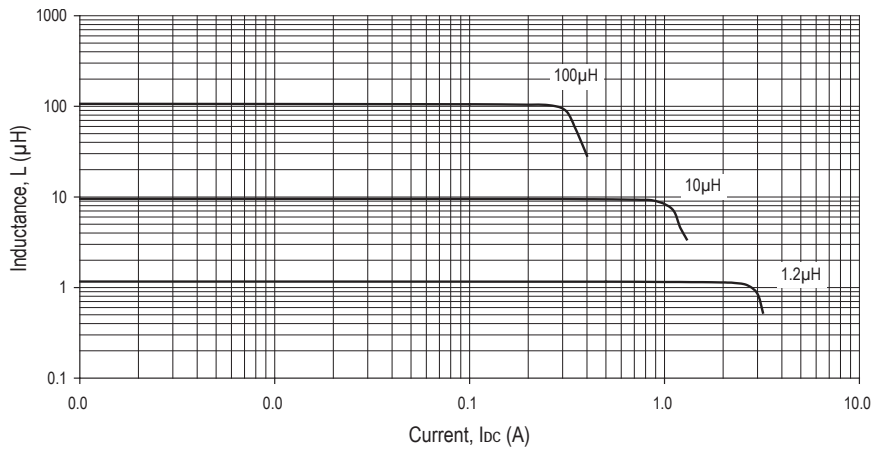

TEMPERATURE Vs CURRENT

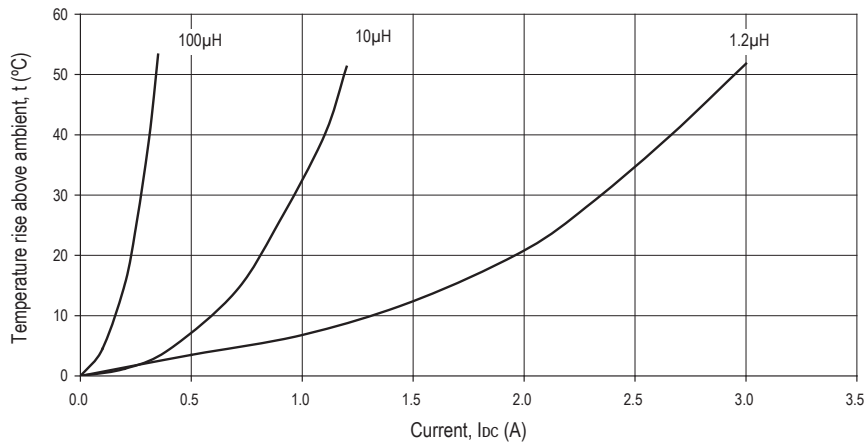

INDUCTANCE Vs FREQUENCY

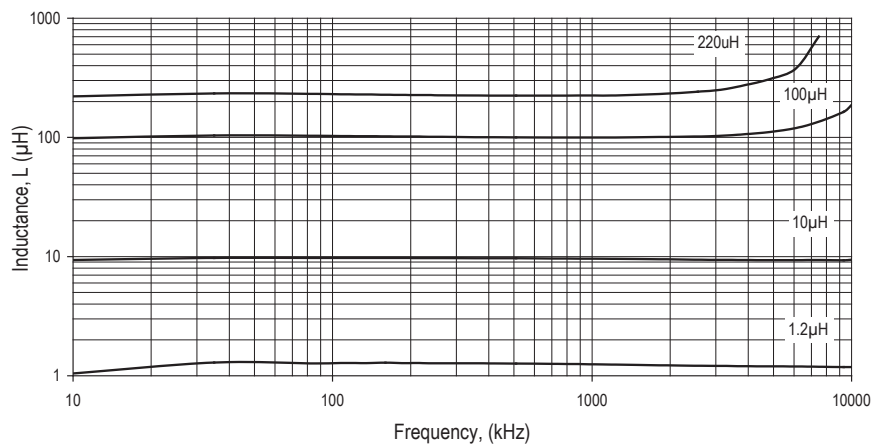

PACKAGE SPECIFICATIONS

Mechanical Dimensions

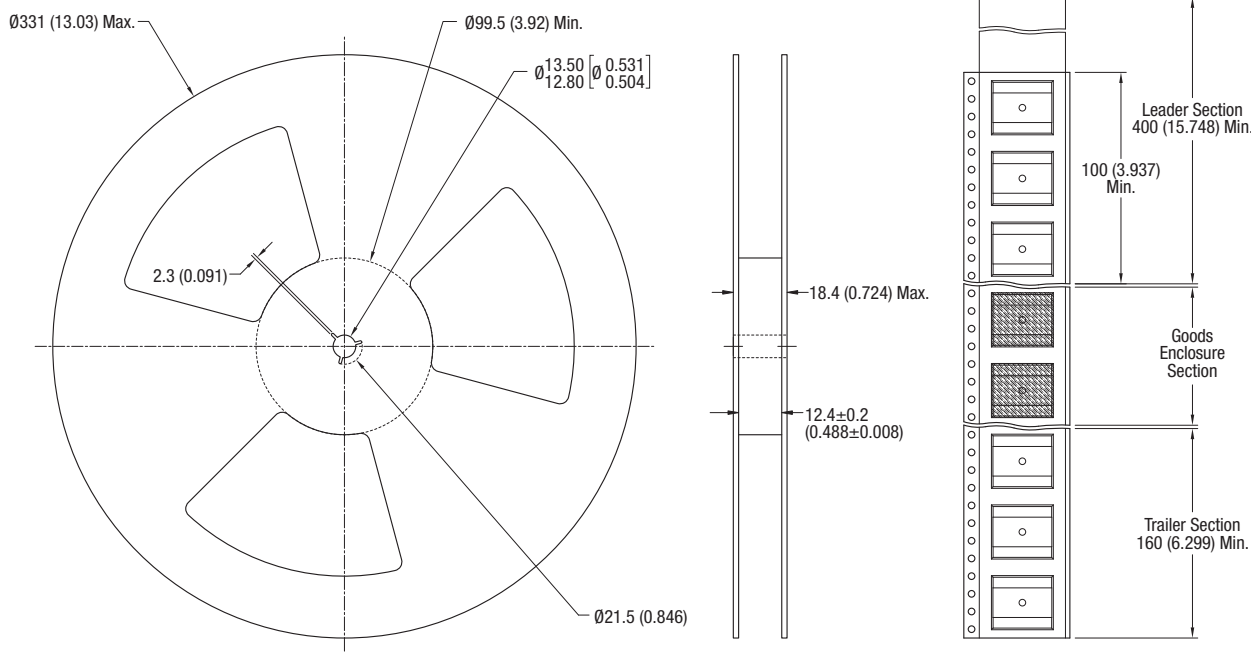

All dimension in mm (inches)

Tape Outline Dimensions

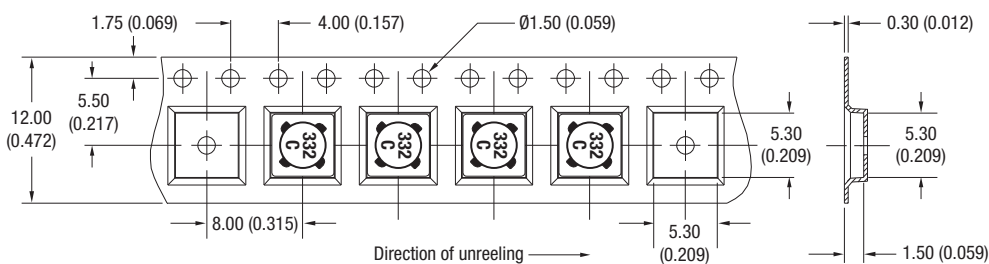

Reel quantity: 4000
Unless otherwise stated, all dimensions in mm (inches).

Murata Power Solutions, Inc.
11 Cabot Boulevard, Mansfield, MA 02048-1151 U.S.A.
ISO 9001 and 14001 REGISTERED

Murata Power Solutions, Inc. makes no representation that the use of its products in the circuits described herein, or the use of other technical information contained herein, will not infringe upon existing or future patent rights. The descriptions contained herein do not imply the granting of licenses to make, use, or sell equipment constructed in accordance therewith. Specifications are subject to change without notice.
© 2013 Murata Power Solutions, Inc.

Mouser Electronics

Authorized Distributor

Click to View Pricing, Inventory, Delivery & Lifecycle Information:

Murata:

[34L223C](#) [34L153C](#) [34L332C](#) [34L333C](#) [34L122C](#) [34L104C](#) [34L683C](#) [34L222C](#) [34L473C](#) [34L152C](#) [34L103C](#)
[34L154C](#) [34L224C](#) [34L472C](#) [34L682C](#)