

Distributed by:

JAMECO[®]
ELECTRONICS

www.Jameco.com ♦ 1-800-831-4242

The content and copyrights of the attached
material are the property of its owner.

Jameco Part Number 880714

FEATURES AND SPECIFICATIONS

Features and Benefits

- Designed for use with strain relief or overmold applications
- Positive housing lock for secure mating retention
- Fully isolated terminals to protect contacts from damage
- Uses standard Mini-Fit series terminals
- 1-piece strain relief available (41995 series) for use with Mini-Fit, Jr. single row receptacles

Reference Information

Product Specification: PS-5556-0001

Packaging: Tray or bag

UL File No.: E29179

CSA File No.: LR19980

TUV License No.: R75142

Mates With: [5559](#), [5566](#), [5569](#), [42404](#), [42440](#), [42475](#),

[43810](#), [43879](#) and [44068](#) dual row connectors

Use With: [5556](#) or 44476 terminals

Designed In: Millimeters

Mechanical

Contact Insertion Force: 1.5kg max.

Contact Retention to Housing: 3.0kg min.

Wire Pull-Out Force: 9.0kg min.

Insertion Force to PCB: 5.0kg max.

Mating Force: 0.7kg (1.54 lb) max.

Unmating Force: 0.35kg (0.7 lb) min.

Normal Force: 200g min.

Durability: 30 cycles

Physical

Housing: 6/6 nylon, UL 94V-2 or 94V-0

Operating Temperature: -40 to +105°C

molex® 4.20mm (.165") Pitch Mini-Fit, Jr.™ Receptacle

5557 Dual Row

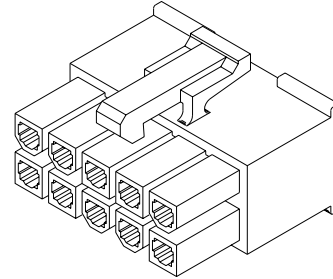

CATALOG DRAWING (FOR REFERENCE ONLY)

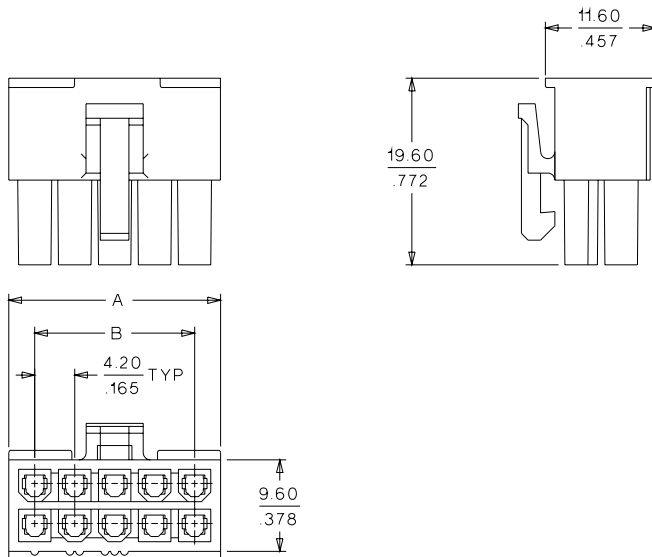

	Order No.
Polarizing Key	15-04-0211

ORDERING INFORMATION AND DIMENSIONS

Circuits	Order No.				Dimension	
	For Use with Strain Relief		Not for Use with Strain Relief		A	B
	94V-2	94V-0	94V-2	94V-0		
2	39-01-3022	39-01-3028	• 39-01-2020	• 39-01-2025	5.40 (.213)	
4	39-01-3042	39-01-3048	• 39-01-2040	• 39-01-2045	9.60 (.378)	4.20 (.165)
6	• 39-01-2060	• 39-01-2065			13.80 (.543)	8.40 (.331)
8	• 39-01-2080	• 39-01-2085			18.00 (.709)	12.60 (.496)
10	• 39-01-2100	• 39-01-2105			22.20 (.874)	16.80 (.661)
12	• 39-01-2120	• 39-01-2125			26.40 (1.039)	21.00 (.827)
14	• 39-01-2140	• 39-01-2145			30.60 (1.205)	25.20 (.992)
16	• 39-01-2160	• 39-01-2165			34.80 (1.370)	29.40 (1.158)
18	• 39-01-2180	• 39-01-2185			39.00 (1.535)	33.60 (1.323)
20	• 39-01-2200	• 39-01-2205			43.20 (1.701)	37.80 (1.488)
22	• 39-01-2220	• 39-01-2225			47.40 (1.866)	42.00 (1.654)
24	• 39-01-2240	• 39-01-2245			51.60 (2.031)	46.20 (1.819)

• US Standard Product, available through Molex franchised distributors



PRODUCT SPECIFICATION

MINI-FIT HCS (High Current System)

1.0 SCOPE

This Product Specification covers performance requirements for the MINI-FIT HCS 4.20 mm (.165 inch) centerline (pitch) printed circuit board (PCB) connector series with Tin or Gold plating, and The MINI-FIT HCS connector series terminated with 16 to 28 AWG wire using Crimp technology with Tin or Gold plating.

2.0 PRODUCT DESCRIPTION

2.1 PRODUCT NAME AND SERIES NUMBER (S)

<u>PRODUCT NAME</u>	<u>PART NUMBER</u>
Female Crimp Terminal (Mini-Fit HCS)	44476-****
Male Crimp Terminal (Mini-Fit HCS)	44478-****
Receptacle Housing (Mini-Fit Jr.)	5557-****
Receptacle Housing (Mini-Fit PTA)	30067-****
Receptacle Housing (Mini-Fit BMI)	42474-****
Receptacle Header Assembly (Mini-Fit BMI)	44475-****
Plug Housing (Mini-Fit Jr.)	5559-****
Plug Housing (Mini-Fit TPA)	30068-****
Plug Housing (Mini-Fit BMI)	42475-****
Vertical Header Assembly (Mini-Fit HCS)	44472-****
Vertical Header Assembly (Mini-Fit TPA)	44473-****
Vertical Header Assembly (Mini-Fit (BMI)	44474-****
Vertical Header Assembly (Mini-Fit SMC)	44068-****
Right Angle Header Assembly (Mini-Fit Jr.)	5569-****
Right Angle Header Assembly (Mini-Fit TPA)	30070-****
Right Angle Header Assembly (Mini-Fit BMI)	42404-****
Right Angle Header Assembly (Mini-Fit SMC)	43810-****

Mating the Mini-Fit receptacles to Mini-Fit plugs or Mini-Fit headers using 44476 or 44478 terminals allow it to qualify as a Mini-Fit HCS system.

2.2 DIMENSIONS, MATERIALS, PLATINGS AND MARKINGS

See the appropriate sales drawings for the information on dimensions, materials, platings and markings.

2.3 SAFETY AGENCY APPROVALS

UL File #E29179
CSA Certificate #LR 19980
TUV Certificate #R75142-8

3.0 APPLICABLE DOCUMENTS AND SPECIFICATIONS

See sales drawings and the other sections of this specification for the necessary referenced documents and specifications

<u>REVISION:</u> D	<u>ECR/ECN INFORMATION:</u> <u>EC No:</u> UCP2003-2604 <u>DATE:</u> 2003 / 06 / 12	<u>TITLE:</u> PRODUCT SPECIFICATION FOR MINI-FIT HCS CONNECTOR SYSTEM	<u>SHEET No.</u> 1 of 5
<u>DOCUMENT NUMBER:</u> PS-44476-001	<u>CREATED / REVISED BY:</u> C.STEWART	<u>CHECKED BY:</u> Y. MARGULIS	<u>APPROVED BY:</u> Y. MARGULIS



PRODUCT SPECIFICATION

NGS

4.1 VOLTAGE

600 Volts AC (RMS) (or 600 Volts DC)

4.2 CURRENT AND APPLICABLE WIRES

Maximum Insulation Diameter and Applicable Wire Gauges	16 AWG: 3.10/. 122 MAXIMUM			
	18-24 AWG: 3.10/. 122 MAXIMUM			
MAXIMUM CURRENT RATING (Amperes)				
Ckt. Size Wire	2 & 3	4 - 6	7 - 10	12 - 24
AWG #16	12	11	10	9
AWG #18	12	11	10	9
AWG #20	9	9	8	8

4.3 TEMPERATURE

Operating: * - 40°C to + 105°C

Nonoperating: - 40°C to + 105°C

**Including 30°C terminal temperature at rated current*

4.0 PERFORMANCE

5.1 ELECTRICAL REQUIREMENTS

ITEM	DESCRIPTION	TEST CONDITION	REQUIREMENT
1	Contact Resistance (Low Level)	Mate connectors: apply a maximum voltage of 20 mV and a current of 100 mA. Wire resistance shall be removed from the measured value.	10 milliohms MAXIMUM [initial]
2	Contact Resistance @ Rated Current	Mate connectors: apply a maximum voltage of 20 mV at rated current.	10 milliohms MAXIMUM [initial]
3	Contact Resistance of Wire Termination (Low Level)	Terminate the applicable wire to the terminal and measure wire using a voltage of 20 mV and a current of 100 mA.	5 milliohms MAXIMUM [initial]

REVISION:	ECR/ECN INFORMATION:	TITLE:	SHEET No.
D	EC No: UCP2003-2604 DATE: 2003 / 06 / 12	PRODUCT SPECIFICATION FOR MINI-FIT HCS CONNECTOR SYSTEM	2 of 5
DOCUMENT NUMBER:	CREATED / REVISED BY:	CHECKED BY:	APPROVED BY:
PS-44476-001	C.STEWART	Y. MARGULIS	Y. MARGULIS



PRODUCT SPECIFICATION

4	Insulation Resistance	Mate connectors: apply a voltage of 500 VDC between adjacent terminals and between terminals to ground.	1000 Megohms MINIMUM
----------	------------------------------	---	-------------------------

5.1 ELECTRICAL REQUIREMENTS (continued)

ITEM	DESCRIPTION	TEST CONDITION	REQUIREMENT
5	Dielectric Withstanding Voltage	Mate connectors: apply a voltage of 1500 VAC for 1 minute between adjacent terminals and between terminals to ground.	No breakdown. Current leakage < 5 mA
6	Temperature Rise (via Current Cycling)	Mate connectors. Measure the temperature rise at the rated current after 96 hours, during current cycling (45 minutes ON and 15 minutes OFF per hour) for 240 hours, and after final 96-hour steady state.	Temperature rise: +30°C MAXIMUM

5.2 MECHANICAL REQUIREMENTS

ITEM	DESCRIPTION	TEST CONDITION	REQUIREMENT
1	Terminal Mate and Unmate Forces	Insert and withdraw terminal (male to female) at a rate of 25 ± 6 mm (1 ± ¼ inch) per minute.	14.7 N (3.30 lbf) MAXIMUM insertion force & 1.0 N (0.02 lbf) MINIMUM withdrawal force
2	Terminal Retention Force (in Housing)	Axial pullout force on the terminal in the housing at a rate of 25 ± 6 mm (1 ± ¼ inch) per minute.	30 N (6.74 lbf) MINIMUM retention force
3	Durability	Mate connectors up to 30 cycles at a maximum rate of 10 cycles per minute prior to Environmental Tests.	20 milliohms MAXIMUM
4	Vibration (Random)	Mate connectors and vibrate per EIA 364-28, test condition VII.	10 milliohms MAXIMUM (change from initial) & Discontinuity < 1 microsecond
5	Shock (Mechanical)	Mate connectors and shock at 50 g's with ½ sine wave (11 milliseconds) shocks in the ±X, ±Y, ±Z axes, (18 shocks total).	20 milliohms MAXIMUM & Discontinuity < 1 microsecond

<u>REVISION:</u> D	<u>ECR/ECN INFORMATION:</u> <u>EC No:</u> UCP2003-2604 <u>DATE:</u> 2003 / 06 / 12	<u>TITLE:</u> PRODUCT SPECIFICATION FOR MINI-FIT HCS CONNECTOR SYSTEM	<u>SHEET No.</u> 3 of 5
<u>DOCUMENT NUMBER:</u> PS-44476-001		<u>CREATED / REVISED BY:</u> C.STEWART	<u>CHECKED BY:</u> Y. MARGULIS
		<u>APPROVED BY:</u> Y. MARGULIS	



PRODUCT SPECIFICATION

6	Wire Pullout Force (Axial)	Apply an axial pullout force on the wire at a rate of 25 ± 6 mm (1 ± ¼ inch).	16 Awg = 88.0 N (19.8 lbf) Min. 18 Awg = 88.0 N (19.8 lbf) Min. 20 Awg = 59.0 N (13.3 lbf) Min. 22 Awg = 39.0 N (8.78 lbf) Min. 24 Awg = 29.0 N (6.52 lbf) Min. 26 Awg = 19.0 N (4.27 lbf) Min. 28 Awg = 9.80 N (2.20 lbf) Min.
----------	-----------------------------------	---	---

5.2 MECHANICAL REQUIREMENTS (continued)

7	Terminal Insertion Force (into Housing)	Apply an axial insertion force on the terminal at a rate of 25 ± 6 mm (1 ± ¼ inch).	15.0 N (3.37 lbf) MAXIMUM insertion force
8	Normal Force	Apply a perpendicular force.	0.49 N (50 grams) MINIMUM [Gold (noble) plating] OR 1.47 N (150 grams) MINIMUM [Tin (non-noble) plating]
9	PCB Engagement and Separation Forces	Engage and separate a connector at a rate of 25 ± 6 mm (1 ± ¼ inch) per minute.	49.0 N (11.0 lbf) MAXIMUM insertion force & 10.0 N (2.24 lbf) MINIMUM withdrawal force
10	Panel Insertion and Withdrawal Forces	Insert and withdraw a connector at a rate of 25 ± 6 mm (1 ± ¼ inch) per minute.	225 N (50.7 lbf) MAXIMUM insertion force & 157 N (35.3 lbf) MINIMUM withdrawal force

5.3 ENVIRONMENTAL REQUIREMENTS

ITEM	DESCRIPTION	TEST CONDITION	REQUIREMENT
1	Thermal Shock	Mate connectors: expose for 5 cycles between temperatures -55 and 105°C; dwell 0.5 hours at each temperature.	20 milliohms MAXIMUM Visual: No Damage Dielectric Strength per 5.1.5 Insulation Resistance per 5.1.4
2	Thermal Aging	Mate connectors; expose to: 96 hours at 105 ± 2°C	20 milliohms MAXIMUM & Visual: No Damage
3	Humidity (Steady State)	Mate connectors: expose to a temperature of 60 ± 2°C with a relative humidity of 90-95% for 96 hours.	20 milliohms MAXIMUM Dielectric Strength per 5.1.5 Insulation Resistance per 5.1.4 Visual: No Damage

<u>REVISION:</u> D	<u>ECR/ECN INFORMATION:</u> <u>EC No:</u> UCP2003-2604 <u>DATE:</u> 2003 / 06 / 12	<u>TITLE:</u> PRODUCT SPECIFICATION FOR MINI-FIT HCS CONNECTOR SYSTEM	<u>SHEET No.</u> 4 of 5
<u>DOCUMENT NUMBER:</u> PS-44476-001		<u>CREATED / REVISED BY:</u> C.STEWART	<u>CHECKED BY:</u> Y. MARGULIS
		<u>APPROVED BY:</u> Y. MARGULIS	



PRODUCT SPECIFICATION

4	Solderability	Per SMES-152	Solder coverage: 95% MINIMUM (per SMES-152)
5	Solder Resistance	Dip connector terminal tails in solder: Solder Duration: 5 ± 0.5 seconds; Solder Temperature: 235 ± 5°C	Visual: No Damage to insulator material

5.3 ENVIRONMENTAL REQUIREMENTS (continued)

ITEM	DESCRIPTION	TEST CONDITION	REQUIREMENT
6	Cold Resistance	Mate connectors: Duration: 96 hours; Temperature: -40 ± 3°C	20 milliohms MAXIMUM Visual: No Damage
7	Corrosive Atmosphere: Sulfur Dioxide Gas (SO₂)	Mate connectors: Duration: 24 hours exposure. Atmosphere: 50 parts per million (ppm) SO ₂ Gas. Temperature: 40 ± 3°C	20 milliohms MAXIMUM Visual: No damage

5.0 PACKAGING

Parts shall be packaged to protect against damage during handling, transit and storage.

REVISION: D	ECR/ECN INFORMATION: EC No: UCP2003-2604 DATE: 2003 / 06 / 12	TITLE: PRODUCT SPECIFICATION FOR MINI-FIT HCS CONNECTOR SYSTEM	SHEET No. 5 of 5
DOCUMENT NUMBER: PS-44476-001	CREATED / REVISED BY: C.STEWART	CHECKED BY: Y. MARGULIS	APPROVED BY: Y. MARGULIS

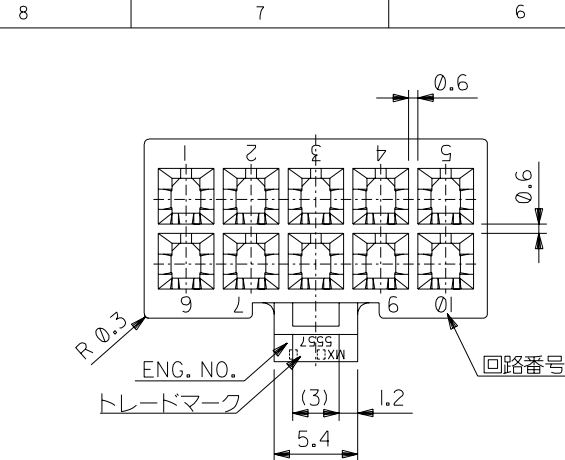

- 注記**
- 適用ターミナル：5556 シリーズ
 - 嵌合相手：5559 シリーズ
5566 シリーズ
5569 シリーズ
- △ D 面の位置にて維持すること。

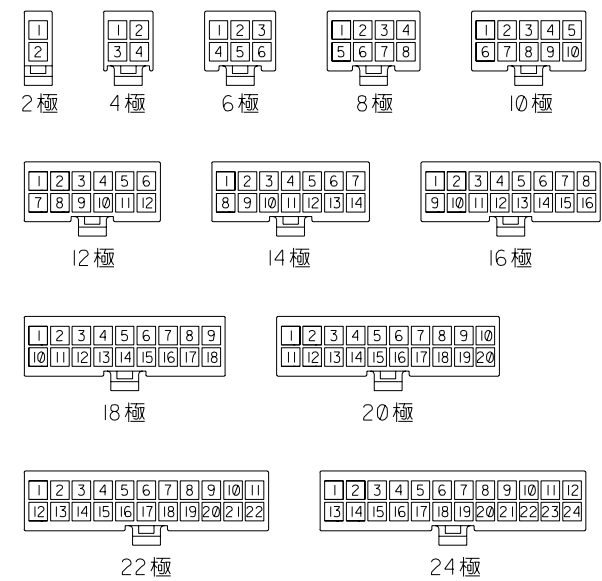
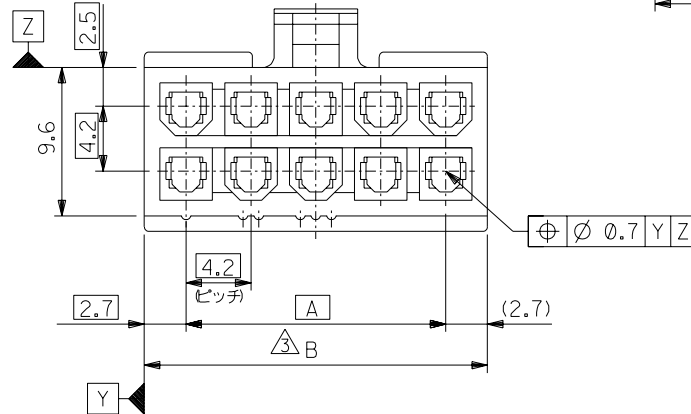
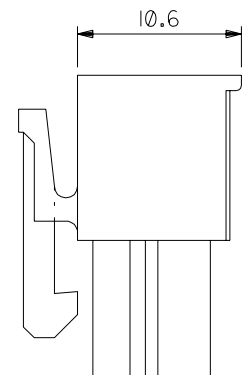
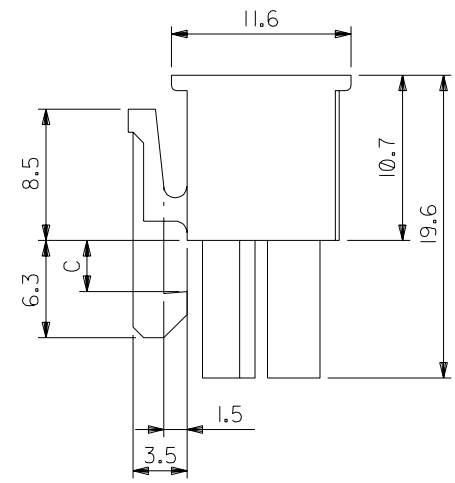
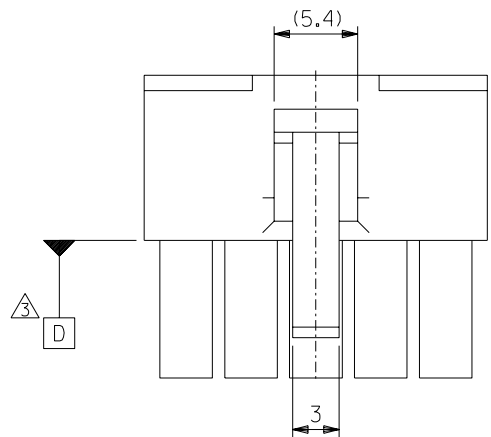

回路レイアウト図
(SCALE: 1-1)

	C	B	A	EDP. NO.	ENG. NO.	極数
3.6	51.6	46.2	39-01-2245	5557-24R-210	24	24
	47.4	42	-2225	-22R-210	22	22
	43.2	37.8	-2205	-20R-210	20	20
	39	33.6	-2185	-18R-210	18	18
3.3	34.8	29.4	-2165	-16R-210	16	16
	30.6	25.2	-2145	-14R-210	14	14
	26.4	21	-2125	-12R-210	12	12
	22.2	16.8	-2105	-10R-210	10	10
	18	12.6	-2085	-08R-210	8	8
	13.8	8.4	-2065	-06R-210	6	6
	9.6	4.2	-2045	-04R-210	4	4
	5.4	—	39-01-2025	5557-02R-210	2	2

角度 ANGLE	±3°	30°以上 OVER	±0.1	10°以上 OVER 30°未満 UNDER	±0.3 ±0.25	未満 10° UNDER	±0.2
一般公差 GENERAL TOLERANCES							
記号 LTR	変更内容 REVISION RECORD	DR. CHK.	日付 DATE	S.A. M.F.	H.H. M.F.	H.H. Y.Y.	S.M. H.H.
G	変更 (JC70586)	S.A. M.F.	97/1/8				
F	変更 (J20850)	H.H. M.F.	92/9/19				
E	変更 (J20158)	H.H. Y.Y.	92/4/20				
D	変更 (J01160)	H.H. Y.Y.	90/11/8				
C	変更及び再作図 (J00192)	S.M. H.H.	90/2/22				
APP'D BY	97/1/8	M.FUKUSHIMA	尺度 SCALE	3 - 1			

材料 MATERIAL
66 ナイロン (UL94V-0)
色: オフホワイト

仕上げ FINISH ————

適用電線範囲 WIRE RANGE ————

被覆外径 INS. RANGE ————

DRAWN BY '90/2/22 S.MOCHIZUKI
CHK'D BY '97/1/8 M.FUKUSHIMA

REVISION RECORD

REVISE ONLY ON CAD SYSTEM

TITLE 名称
NEW MINI FIT CONN.
REC. HOUSING

DWG. NO. SD-5557-NR-210
REV G

ENG. NO.
SD-5557-NR-210

EDP NO.
39-01-2**5

:MM DIMENSIONS IN METRIC DO NOT SCALE DRAWING

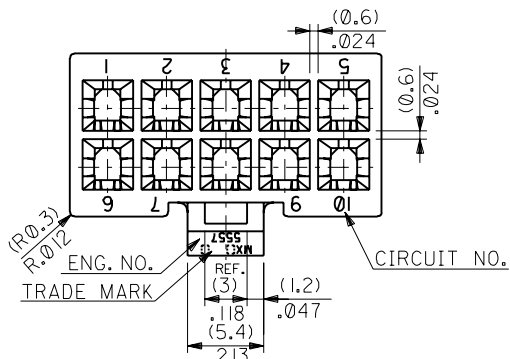

NOTES

1. TERMINAL : 5556 SERIES
2. MATE WITH : 5559 SERIES
5566 SERIES
5569 SERIES
3. (METRIC) VALUES SHOWN GOVERN OVER ENGLISH CONVERSION VALUES.
△ TO BE MEASURED AT POSITION OF □ SURFACE.

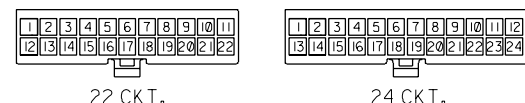
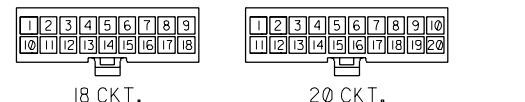
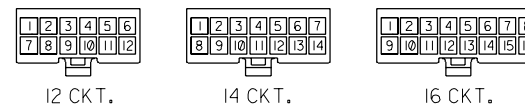
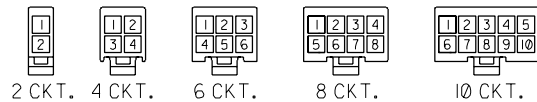

CIRCUIT SIZE LAYOUT
(SCALE: 1-1)

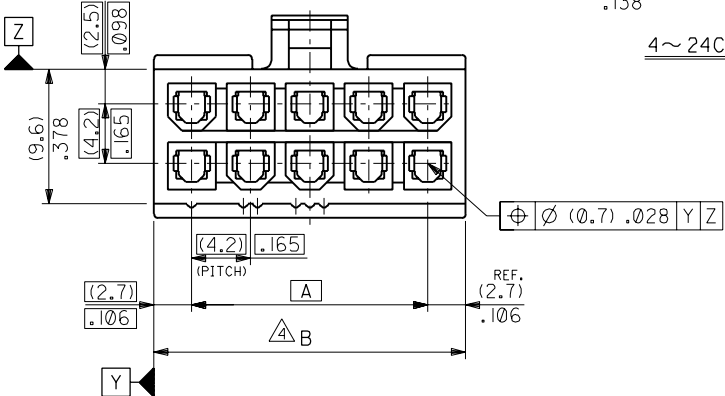
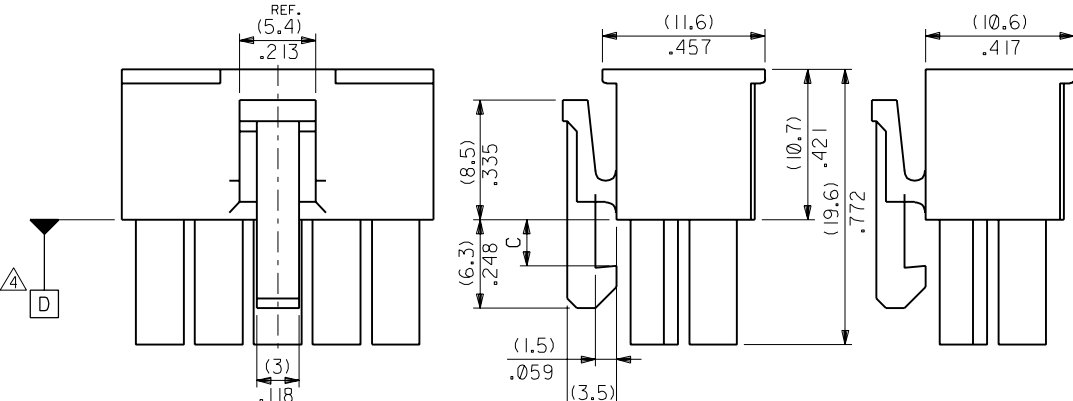

4~24CKT.

2CKT.

	(51.6)	2.031	(46.2)	1.819	39-01-2245	5557-24R-210	24
(3,6)	(47.4)	1.866	(42)	1.654	↑ -2225	↑ -22R-210	22
.142	(43.2)	1.701	(37.8)	1.488	-2205	-20R-210	20
	(39)	1.535	(33.6)	1.323	-2185	-18R-210	18
	(34.8)	1.37	(29.4)	1.158	-2165	-16R-210	16
	(30.6)	1.205	(25.2)	.992	-2145	-14R-210	14
	(26.4)	1.039	(21)	.827	-2125	-12R-210	12
(3,3)	(22.2)	.874	(16.8)	.661	-2105	-10R-210	10
.129	(18)	.709	(12.6)	.496	-2085	-08R-210	8
	(13.8)	.543	(8.4)	.331	-2065	-06R-210	6
	(9.6)	.378	(4.2)	.165	↓ -2045	↓ -04R-210	4
	(5.4)	.213	+		39-01-2025	5557-02R-210	2
					A		
	C	B	A		EDP. NO.	ENG. NO.	NO. OF CKTS.

材料 MATERIAL 66NYLON (UL94V-0)		MOLEX-JAPAN CO.,LTD. 日本モレックス株式会社	
F	REVISED (JC70586)	S.A. M.F	9/11/8
E	REVISED (J20158)	H.H	9/24/20
D	REVISED (J01160)	H.H Y.Y	9/01/18
C	REVISED & REDRAWN (J00192)	S.M. H.H	9/02/22
DRAWN BY 9/02/22 S.MOCHIZUKI		CHK'D BY 9/07/08 M.FUKUSHIMA	
APP'D BY 9/07/08 M.FUKUSHIMA		尺度 SCALE 3 - 1	
REVISION RECORD		DATE	
LTR		DR. CHK.	
REVISION RECORD			
GENERAL TOLERANCES			
角度 ANGLE	+3°		
30° 以上 OVER	+0.3		
10° 以上 30° 未満 UNDER	+0.25		
10° 未満 UNDER	+0.2		
一般公差 GENERAL TOLERANCES			

EDP. NO.
39-01-2**5

ENG. NO.
SD-5557-NR-210

REV F

TITLE 名称
NEW MINI FIT CONN.
REC. HOUSING

THIS DRAWING CONTAINS INFORMATION THAT IS PROPRIETARY TO MOLEX(JAPAN) AND SHOULD NOT BE USED WITHOUT WRITTEN PERMISSION
本図面は日本モレックス(株)の所有する情報を含むもので 会社の許可なく複製を禁止する。