

***selos / fasis***

DIN Rail Terminal Blocks with  
Screw, Tension Spring and Push-In  
Connection Technologies  
Catalog 2015





▲ Sales Center in Bamberg



▲ Company headquarters in Bamberg



▲ STOCKO main plant in Wuppertal

# wieland group

## ACTIVE WORLDWIDE

The Wieland Group employs more than 2,000 people all around the globe. With current 15 locations and subsidiaries, and sales partners in more than 70 countries, Wieland Holding is present in nearly all important key markets worldwide.

Always with a clear commitment to the German location where most of the products are still manufactured.



*automation*

*building*

*electronics*

## The group makes us strong

Wieland Holding is based in Bamberg, Bavaria, and comprises two independently acting subsidiaries: Wieland Electric and STOCKO Contact.

Groundbreaking innovations made Wieland Electric one of the leading suppliers of electrical connection technology. This company, founded in Bamberg in 1910, is the largest subsidiary of Wieland Holding.

STOCKO Contact is based in Wuppertal and joined the Wieland Group in 2001. Stocko has also more than 100 years of company history to its credit and is one of the largest manufacturers of connector systems and crimp contacts.



**Established in industries**

Control cabinet engineering, industrial automation, building system technology – our large product portfolio provides solutions for all kinds of applications.

From innovative interface and network technology to terminal blocks to "safety first" – with modular system solutions and safety components. With Wieland products in your control cabinet, you are always on the safe side.

Energy bus systems for distributed automation or indoor and outdoor field

bus components – Wieland technology can be found everywhere, and in all kinds of applications.

In building system technology, Wieland Electric is the world market leader in pluggable electrical installation.

There are good reasons why our system solutions can be found in the most spectacular building projects worldwide. When it comes to electronic networking, Wieland leads the way to the "smart home".

**Welcome Future**

Wieland Electric is 100 years young, and full of innovative energy. And our commitment for the future is not only to find constantly new system solutions for our customers but also social responsibility.

Environmentally friendly high-tech products, manufactured to the latest production standards, an audited environmental management system and substantial investments in our locations are all part to this concept.

Global commitment and sustainable regional action – Wieland Electric is fit for the future: Contacts are green.



# Wieland DIN Rail Terminal Blocks – Overview

## DIN rail terminal blocks with screw connection

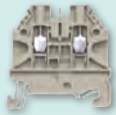

Feed-through blocks  
starting at page 12



Ground blocks  
starting at page 16



Duo feed-through blocks  
starting at page 20

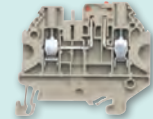

Knife edge  
disconnect blocks  
starting at page 20+31

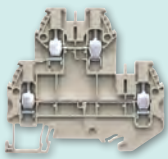

Multi-tier blocks  
starting at page 22



Initiator blocks  
starting at page 26



Fuse blocks  
starting at page 28

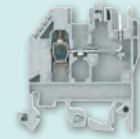

DIN rail terminal blocks  
with plug-in connection  
starting at page 34

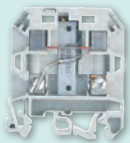

Function blocks  
starting at page 24+38

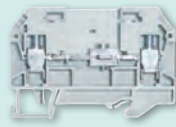

Instrument isolating  
terminals  
starting at page 40

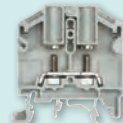

DIN rail terminal blocks  
with ring lug connection  
starting at page 45



High current terminal blocks  
starting at page 46



Mini blocks  
starting at page 54



**selos** CLASSIC  
starting at page 56

## DIN rail terminal blocks with push-in connection



Feed-through blocks  
starting at page 118



Ground blocks  
starting at page 120

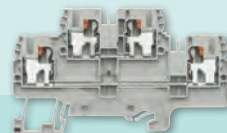

Duo feed-through blocks  
starting at page 122

## DIN rail terminal blocks with tension spring connection



Feed-through blocks  
starting at page 66



Ground blocks  
starting at page 76

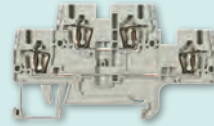

Duo feed-through blocks  
starting at page 82



Knife edge  
disconnect blocks  
starting at page 92

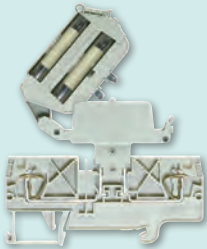

Fuse blocks  
starting at page 94

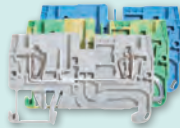

DIN rail terminal blocks  
with plug-in connection  
starting at page 98



Initiator blocks  
starting at page 104



Mini blocks  
starting at page 108

## Accessories, software and service



Accessories  
starting at page 124



Software  
starting at page 144



Service, Facts & Data  
starting at page 145



# Wieland DIN Rail Terminal Blocks – One System

**3 product families, 3 connection technologies** – our DIN rail terminal block program is the right choice for every installation, wherever the control cabinet is found – in machinery or plant engineering, energy technology or building installation, or with **screw, tension spring** or **push-in** connection.

The ultimately flexible DIN rail terminal block systems **selos** and **fasis** offer optimum handling and harmonized accessories. This guarantees not only fast wiring time, but also reduces cost of inventory at your facility and in the supply chain.

Customized assembly service, customer-specific solutions and a comprehensive service portfolio match our products individually with the requirements of our customers.

## DIN rail terminal blocks with screw connection – **selos**

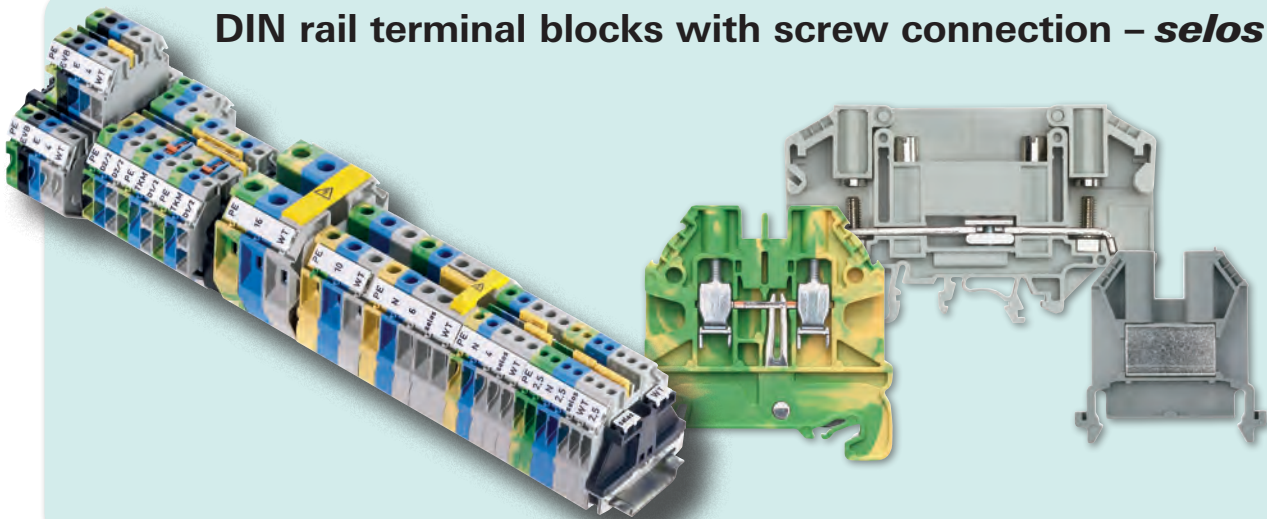

## DIN rail terminal blocks with push-in connection – **fasis** WTP

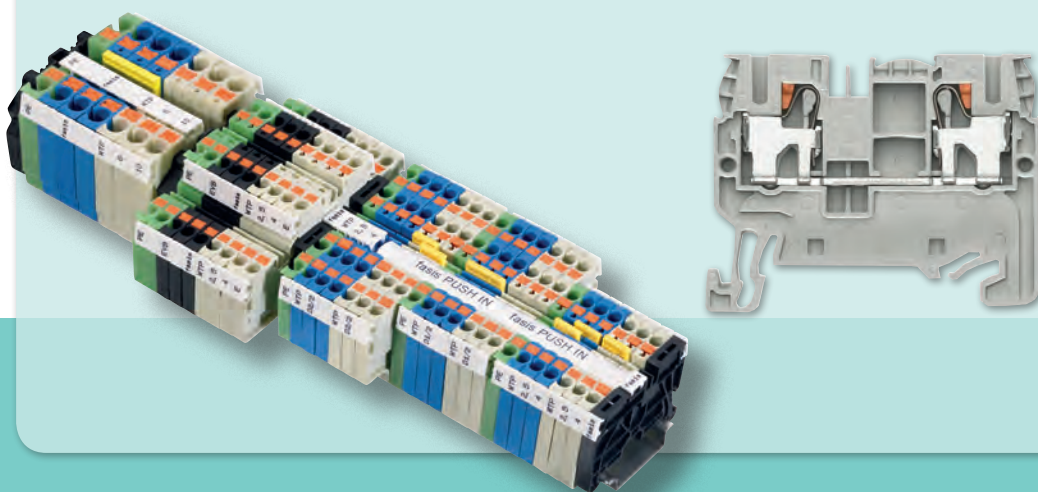

## - Many Possibilities

DIN rail terminal blocks with tension spring connection  
- **fasis** WKFN

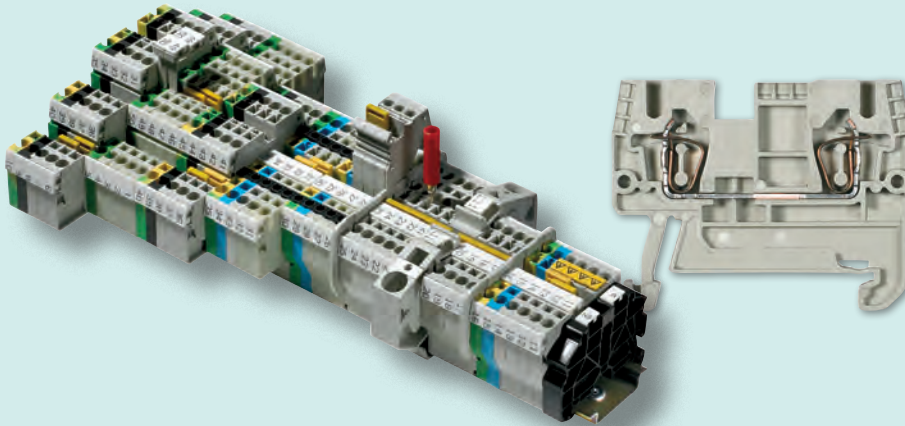

## Accessories, software and service

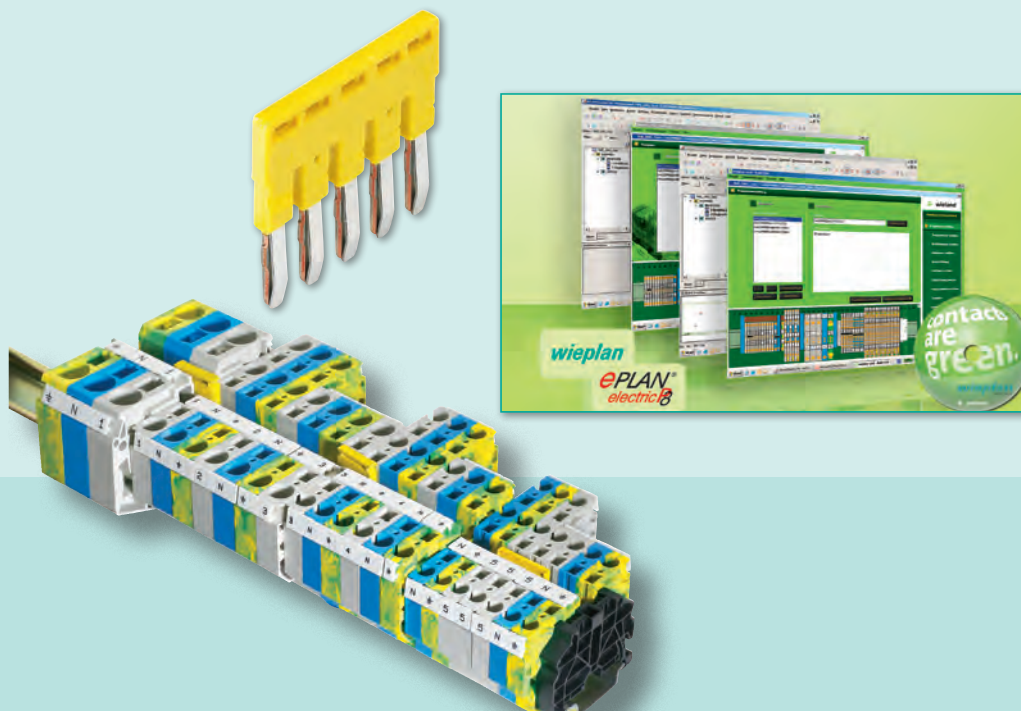

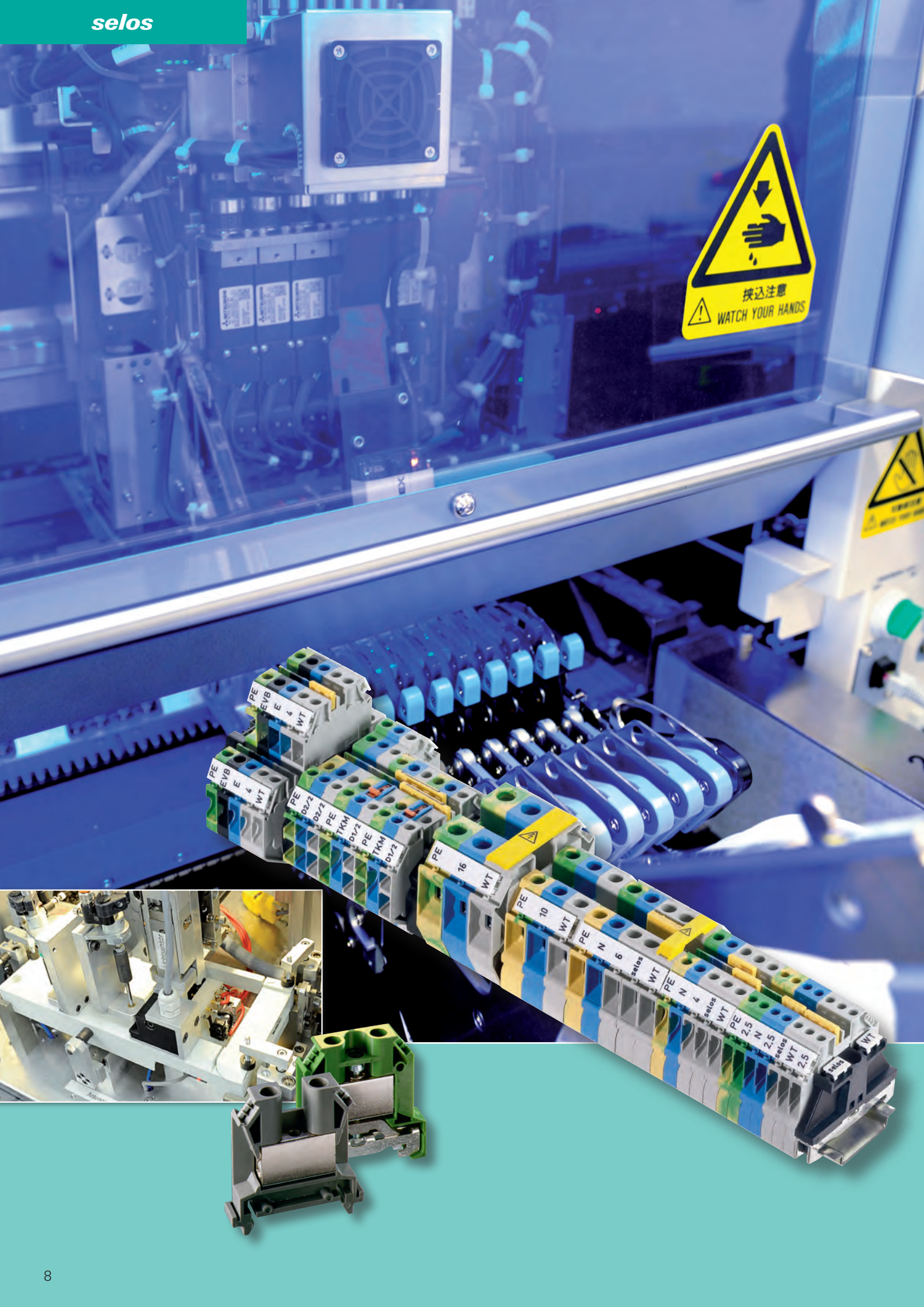



## **selos** – DIN Rail Terminal Blocks with **Screw Connection**

Reliable connection, proven concept! **selos** is our DIN rail terminal block with screw connection, solid and functional, known worldwide, and in use millions of times over.

The **selos** series combines the classic screw connection with modern connection technology, with the focus on customer benefits and increased efficiency in wiring and the supply chain.

The **selos** CLASSIC series offers the highest-quality connecting technology. Thanks to its unique clamping body design, aluminum or copper wire connections are long-lasting and maintenance-free.

The **selos** product line includes feed-through and ground blocks with 2, 3 or 4 termination points, multi-tier blocks in two- and three-tier designs, knife-edge disconnect blocks and fuse blocks. In addition, specialty function blocks are available with a wide variety of diode circuits and diverse application-specific terminals, such as transformer disconnect terminals.

**selos** has been designed for use in machinery and plant construction as well as hazardous locations subject to explosion.

Connection cross-section up to 300 mm<sup>2</sup>

Rated current up to 520 A

Rated voltage up to 1000 V

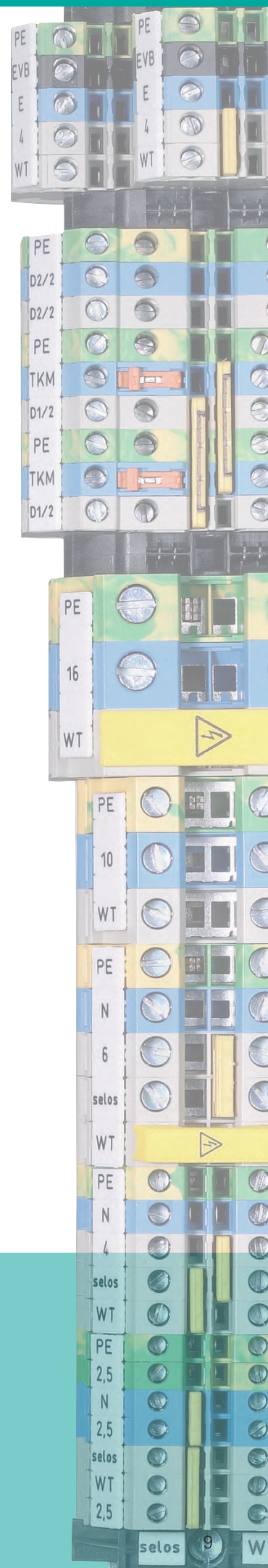
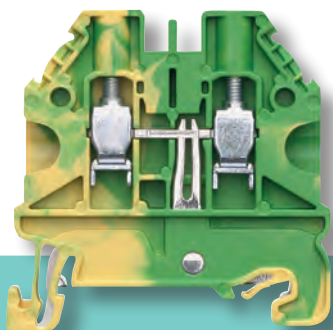

## DIN Rail Terminal Blocks with Screw Connection

### Simply connect

- Multi-wire connection
- Connect with or without ferrules

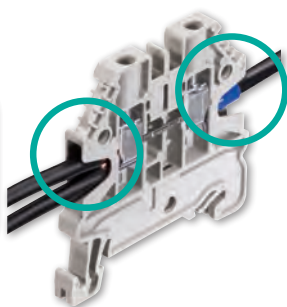

### Reliable and maintenance-free

- Rugged clamping body design
- One-piece threaded collar
- Stress-free connecting and reconnecting

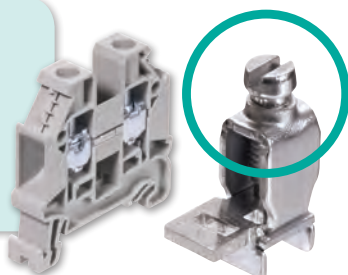

### Smaller size

### Uniform design

### Fewer accessories

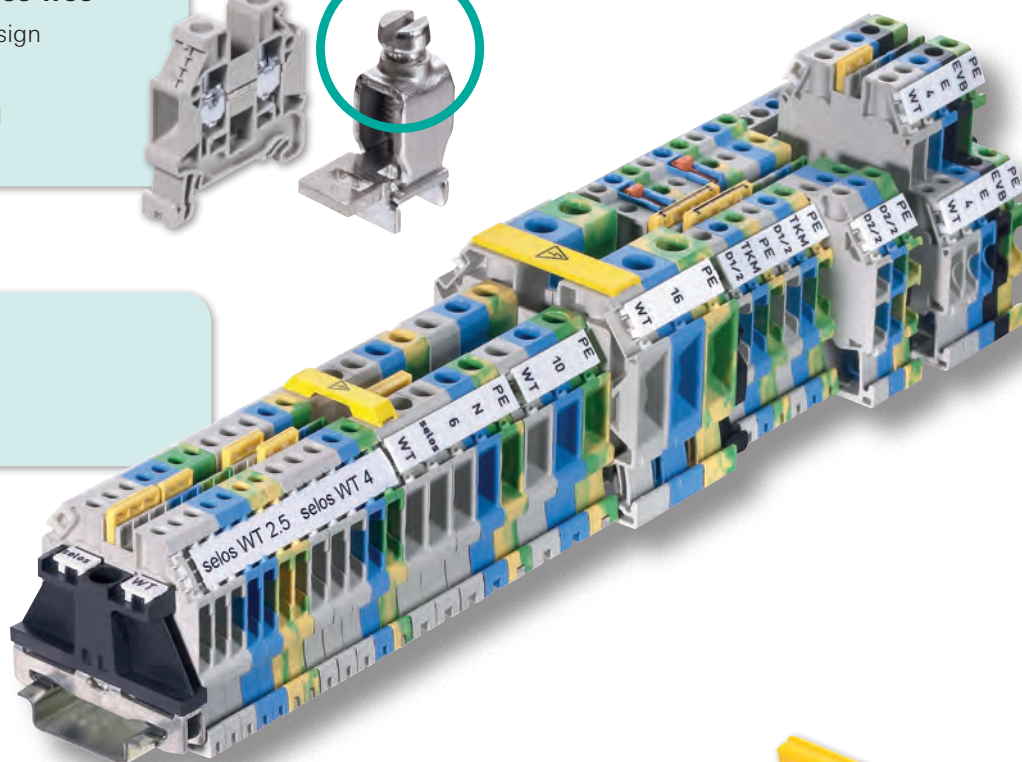

### Time-saving assembly

- Snap-on screwless ground blocks

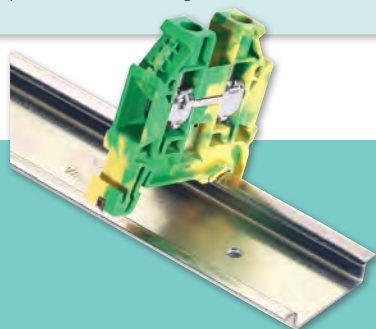

### Plug & Play

- Dual jumpering channels
- Plug-in jumper bars
- Plug-in test adapter



## Wieland jumpering system – Perfect technology

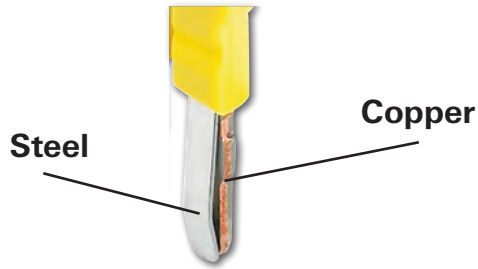
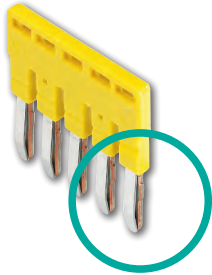

### Perfect technology

- Copper current bar guarantees low contact resistance
- Steel spring guarantees strength, durability, and long-term stability

### Extremely rugged!

- Indestructible steel spring
- Vibration-proof connection



### Simple customization

- Individual poles easy to remove
- Circuits easy to identify



## Wieland marking system – Reliable identification

### Marking strips – Dependable

- Maximum hold to the terminal
- Solidify integrity of rail assembly

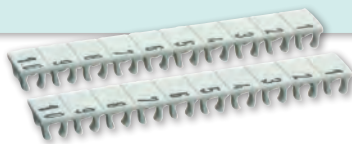

### Endless strip – Effective

- Mounting facility for endless strips permits single step marking of entire assembly
- Continuous labeling
- Uses commercially available labeling systems



### Marking tags – Individual

- Individual labeling with minimum effort
- Ideal for service and maintenance





## Feed-through blocks with screw connection

### WT 2,5

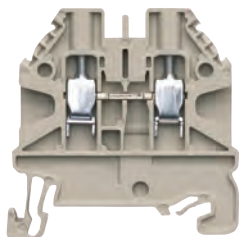
- Feed-through block with screw connection for mounting on TS 35
- Nominal cross section 2.5 mm<sup>2</sup>
-  II 2G 2D Ex eb IIC  
EN 60079-0:12+A11:13 / IEC 60079-0:2011 Ed:6.0  
EN 60079-7:07 / IEC 60079-7:2006-07 Ed:4  
Follow the EX installation instructions on page 149
- Max. electrical data: 32 A/4 mm<sup>2</sup>
- Connection capacity: 2 wires, equal size  
0.14 – 1.5 mm<sup>2</sup>





Description	Type	Part No.	Std. Pack
Feed-through block, gray	WT 2,5	58.503.0055.0	100
Feed-through block, blue	WT 2,5 BL	58.503.0055.6	100
<b>General data</b>			
Width / length / height, incl. TS 7.5	5 mm / 48 mm / 48 mm		
Wire strip length	9 mm	IECEx SEV14.0004 U	
Approvals	 ATEX IECEx SEV 14 ATEX 0124 U		
<b>Technical data</b>	<b>IEC</b>	<b>UL</b>	<b>CSA</b>
	EN 60 947-7-1		
Cross section fine-stranded	0.14–4 mm <sup>2</sup>		0.14–4 mm <sup>2</sup>
Cross section solid/stranded	0.14–4 mm <sup>2</sup>		0.14–4 mm <sup>2</sup>
Cross section, AWG		26–12	26–12
Rated current	24 A	20 A	20 A
Rated voltage	1000 V	600 V	600 V
Rated impulse voltage	8 kV		690 V
Pollution degree	3		
<b>Accessories</b>			
	Type	Part No.	Std. Pack
End plate	AP WT 2,5-10	07.313.2555.0	10
Cross connector	2 pole IVB WKF 2,5-2	Z7.280.6227.0	10
	3 pole IVB WKF 2,5-3	Z7.280.6327.0	10
	4 pole IVB WKF 2,5-4	Z7.280.6427.0	10
	5 pole IVB WKF 2,5-5	Z7.280.6527.0	10
	10 pole IVB WKF 2,5-10	Z7.280.7027.0	20
	20 pole IVB WKF 2,5-20	Z7.280.8027.0	20

### WT 4

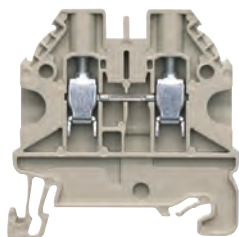
- Feed-through block with screw connection for mounting on TS 35
- Nominal cross section 4 mm<sup>2</sup>
-  II 2G 2D Ex eb IIC  
EN 60079-0:12+A11:13 / IEC 60079-0:2011 Ed:6.0  
EN 60079-7:07 / IEC 60079-7:2006-07 Ed:4  
Follow the EX installation instructions on page 149
- Max. electrical data: 41 A/6 mm<sup>2</sup>
- Connection capacity: 2 wires, equal size  
0.14 – 2.5 mm<sup>2</sup>





Description	Type	Part No.	Std. Pack
Feed-through block, gray	WT 4	58.504.0055.0	100
Feed-through block, blue	WT 4 BL	58.504.0055.6	100
<b>General data</b>			
Width / length / height, incl. TS 7.5	6 mm / 48 mm / 48 mm		
Wire strip length	9 mm	IECEx SEV 14.0004 U	
Approvals	 ATEX IECEx SEV 14 ATEX 0124 U		
<b>Technical data</b>	<b>IEC</b>	<b>UL</b>	<b>CSA</b>
	EN 60 947-7-1		
Cross section fine-stranded	0.14–6 mm <sup>2</sup>		0.14–6 mm <sup>2</sup>
Cross section solid/stranded	0.14–6 mm <sup>2</sup>		0.14–6 mm <sup>2</sup>
Cross section, AWG		26–10	26–10
Rated current	32 A	30 A	30 A
Rated voltage	1000 V	600 V	600 V
Rated impulse voltage	8 kV		690 V
Pollution degree	3		
<b>Accessories</b>			
	Type	Part No.	Std. Pack
End plate	AP WT 2,5-10	07.313.2555.0	10
Cross connector	2 pole IVB WKF 4-2	Z7.261.1227.0	10
	3 pole IVB WKF 4-3	Z7.261.1327.0	10
	4 pole IVB WKF 4-4	Z7.261.1427.0	10
	5 pole IVB WKF 4-5	Z7.261.1527.0	10
	10 pole IVB WKF 4-10	Z7.261.2027.0	20

### WT 6

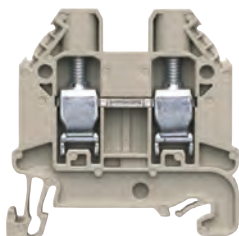
- Feed-through block with screw connection for mounting on TS 35
- Nominal cross section 6 mm<sup>2</sup>
-  II 2G 2D Ex eb IIC  
EN 60079-0:12+A11:13 / IEC 60079-0:2011 Ed:6.0  
EN 60079-7:07 / IEC 60079-7:2006-07 Ed:4  
Follow the EX installation instructions on page 149
- Max. electrical data: 57 A/10 mm<sup>2</sup>
- Connection capacity: 2 wires, equal size  
0.2 – 4 mm<sup>2</sup>





Description	Type	Part No.	Std. Pack
Feed-through block, gray	WT 6	58.506.0055.0	100
Feed-through block, blue	WT 6 BL	58.506.0055.6	100
<b>General data</b>			
Width / length / height, incl. TS 7.5	8 mm / 48 mm / 48 mm		
Wire strip length	11 mm	IECEx SEV 14.0004 U	
Approvals	 ATEX IECEx SEV 14 ATEX 0124 U		
<b>Technical data</b>	<b>IEC</b>	<b>UL</b>	<b>CSA</b>
	EN 60 947-7-1		
Cross section fine-stranded	0.2–10 mm <sup>2</sup>		0.2–10 mm <sup>2</sup>
Cross section solid/stranded	0.2–10 mm <sup>2</sup>		0.2–10 mm <sup>2</sup>
Cross section, AWG		24–8	24–8
Rated current	41 A	50 A	50 A
Rated voltage	1000 V	600 V	600 V
Rated impulse voltage	8 kV		550 V
Pollution degree	3		
<b>Accessories</b>			
	Type	Part No.	Std. Pack
End plate	AP WT 2,5-10	07.313.2555.0	10
Cross connector	2 pole IVB WKFN 6-2	Z7.282.5227.0	10
	3 pole IVB WKFN 6-3	Z7.282.5327.0	10
	4 pole IVB WKFN 6-4	Z7.282.5427.0	10
	5 pole IVB WKFN 6-5	Z7.282.5527.0	10

### WT 10

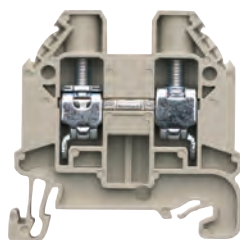
- Feed-through block with screw connection for mounting on TS 35
- Nominal cross section 10 mm<sup>2</sup>
-  II 2G 2D Ex eb IIC  
EN 60079-0:12+A11:13 / IEC 60079-0:2011 Ed:6.0  
EN 60079-7:07 / IEC 60079-7:2006-07 Ed:4  
Follow the EX installation instructions on page 149
- Max. electrical data: 76 A/16 mm<sup>2</sup>
- Connection capacity: 2 wires, equal size 0.5 – 6 mm<sup>2</sup>



Description	Type	Part No.	Std. Pack
Feed-through block, gray	WT 10	58.510.0055.0	50
Feed-through block, blue	WT 10 BL	58.510.0055.6	50

General data				
Width / length / height, incl. TS 7.5	10 mm / 48 mm / 48 mm			
Wire strip length	13 mm	IECEx SEV 14.0004 U		
Approvals	  ATEX IECEx		SEV 14 ATEX 0124 U	
Technical data	IEC	UL	CSA	
	EN 60 947-7-1			
Cross section fine-stranded	0.5–16 mm <sup>2</sup>			0.5–16 mm <sup>2</sup>
Cross section solid/stranded	0.5–16 mm <sup>2</sup>			0.5–16 mm <sup>2</sup>
Cross section, AWG		20–6	20–6	
Rated current	57 A	65 A	65 A	57 A
Rated voltage	1000 V	600 V	600 V	690 V
Rated impulse voltage	8 kV			
Pollution degree	3			



Accessories	Type	Part No.	Std. Pack
End plate	AP WT 2,5-10	07.313.2555.0	10
Cross connector	2 pole IVB WKF 10-2	Z7.283.8227.0	10

### WT 16

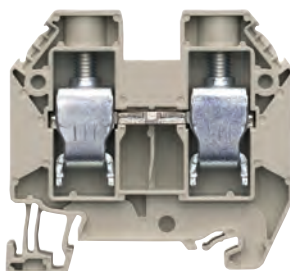
- Feed-through block with screw connection for mounting on TS 35
- Nominal cross section 16 mm<sup>2</sup>
-  II 2G 2D Ex eb IIC  
EN 60079-0:12+A11:13 / IEC 60079-0:2011 Ed:6.0  
EN 60079-7:07 / IEC 60079-7:2006-07 Ed:4  
Follow the EX installation instructions on page 149
- Max. electrical data: 101 A/25 mm<sup>2</sup>
- Connection capacity: 2 wires, equal size 2.5 – 10 mm<sup>2</sup>



Description	Type	Part No.	Std. Pack
Feed-through block, gray	WT 16	58.516.0055.0	50
Feed-through block, blue	WT 16 BLAU	58.516.0055.6	50

General data				
Width / length / height, incl. TS 7.5	12 mm / 58 mm / 54mm			
Wire strip length	15 mm	IECEx SEV 14.0004 U		
Approvals	  ATEX IECEx		SEV 14 ATEX 0124 U	
Technical data	IEC	UL	CSA	
	EN 60 947-7-1			
Cross section fine-stranded	4–25 mm <sup>2</sup>			4–25 mm <sup>2</sup>
Cross section solid/stranded	1.5–25 mm <sup>2</sup>			1.5–25 mm <sup>2</sup>
Cross section, AWG		16–4	16–4	
Rated current	76 A	85 A	85 A	76 A
Rated voltage	1000 V	600 V	600 V	690 V
Rated impulse voltage	8 kV			
Pollution degree	3			

Accessories	Type	Part No.	Std. Pack
End plate	AP WT 16	07.313.2755.0	10
Cross connector	2 pole IVB WKF 16-2	Z7.284.4227.0	10

## Accessories for selos WT 2,5 – WT 16

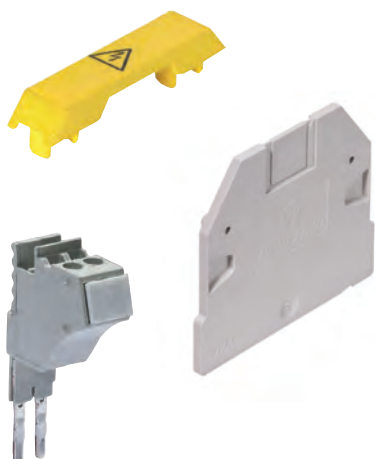

Accessories		Type	Part No.	Std. Pack
Cover with warning symbol	for WT 2,5	AD WT 2,5	04.344.1455.8	10
	for WT 4	AD WT 4	04.344.1655.8	10
	for WT 6	AD WT 6/10	04.344.1855.8	10
	for WT 10	AD WT 6/10	04.344.1855.8	10
	for WT 16	AD WT 16	04.344.2255.8	10
Partition for WT 2,5 – WT 10		TW WT 2,5-10	07.313.2655.0	10
Partition for WT 16		TW WT 4E	07.313.2855.0	10
Test adapter modular for WT 2,5 and 4		PS WKC/F	Z1.299.9753.0	10
End plate for test adapter *		ZP/AP PS	07.312.6053.0	10

\* for WT4 an end cover plate must be snapped in after each test connector

# Feed-through blocks with screw connection

## WKN 35/U

- Feed-through block with screw connection for mounting on TS 35 and TS 32
- Nominal cross section 35 mm<sup>2</sup>
- Ex e I/II  II 2GD IM2  
Follow the EX installation instructions on page 149
- Enclosed design

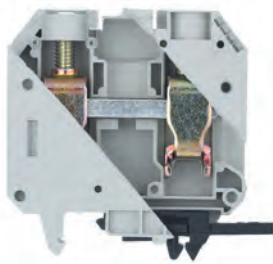

Description	Type	Part No.	Std. Pack
Feed-through block, gray	WKN 35/U	57.535.0155.0	20
Feed-through block Exi, blue	WKN 35/U BLAU	57.535.0155.6	20
<b>General data</b>			
Width / length / height, incl. TS 7.5	16 mm / 71 mm / 68 mm		
Wire strip length	18 mm		
Approvals	 KEMA 02 ATEX 2114 U		
<b>Technical data</b>	<b>IEC</b>	<b>UL</b>	<b>CSA</b>
	EN 60 947-7-1		EN 60 079-0/-7
Cross section fine-stranded	10–35 mm <sup>2</sup>	10–1/0 AWG	10–35 mm <sup>2</sup>
Cross section solid/stranded	10–50 mm <sup>2</sup>		10–50 mm <sup>2</sup>
Rated current	125 A	150 A	86/124 A
Rated voltage	1000 V	600 V	600 V
Rated impulse voltage	8 kV		690 V <sup>1)</sup>
Pollution degree	3		
<b>Accessories</b>			
Partition, gray	TWN 35	07.311.7855.0	10
Cross connector with screws, insulated	2 pole 3 pole	IVB WKN 35 - 2 IVB WKN 35 - 3	5 5
	up to 6 pole	IVB WKN 35 - 6	5
	up to 12 pole	IVB WKN 35 - 12	5
Single cover with marking facility	AD VB 35 GELB	04.326.2553.8	10
Cover with warning symbol over 4 blocks	AD VB 16/4 GELB	04.343.5256.8	10

## WKN 70/U

- Feed-through block with screw connection for mounting on TS 35 and TS 32
- Nominal cross section 70 mm<sup>2</sup>
- Ex e I/II  II 2GD IM2  
Follow the EX installation instructions on page 149
- Enclosed design

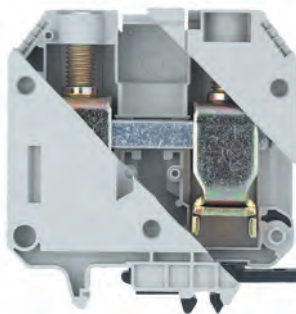

Description	Type	Part No.	Std. Pack
Feed-through block, gray	WKN 70/U	57.570.0155.0	20
Feed-through block Exi, blue	WKN 70/U BLAU	57.570.0155.6	20
<b>General data</b>			
Width / length / height, incl. TS 7.5	24 mm / 77 mm / 81 mm		
Wire strip length	24 mm		
Approvals	 KEMA 02 ATEX 2114 U		
<b>Technical data</b>	<b>IEC</b>	<b>UL</b>	<b>CSA</b>
	EN 60 947-7-1		EN 60 079-0/-7
Cross section fine-stranded	10–70 mm <sup>2</sup>	6–2/0 AWG	10–70 mm <sup>2</sup>
Cross section solid/stranded	16–95 mm <sup>2</sup>		16–95 mm <sup>2</sup>
Rated current	192 A	175/175 A	170 A
Rated voltage	1000 V	600 V	600 V
Rated impulse voltage	8 kV		690 V
Pollution degree	3		
<b>Accessories</b>			
Partition, gray	TWN 70	07.311.7955.0	10
Cross connector with screws, insulated	2 pole 3 pole	VB WKN 70 - 2 VB WKN 70 - 3	10 10
	up to 6 pole	VB WKN 70 - 6	10
Single cover with marking facility	AD VB 70 GELB	04.326.2653.8	10
Cover with warning symbol over 4 blocks	AD VB 24/4 GELB	04.343.5356.8	10

## WKN 150/U

- Feed-through block with screw connection for mounting on TS 35 and TS 32
- Nominal cross section 150 mm<sup>2</sup>
- Ex e I/II  II GD IM2  
Follow the EX installation instructions on page 149
- Enclosed design

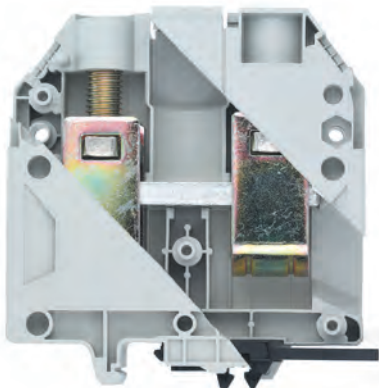

Description	Type	Part No.	Std. Pack
Feed-through block, gray	WKN 150/U	57.597.0155.0	10
Feed-through block Exi, blue	WKN 150/U BLAU	57.597.0155.6	10
<b>General data</b>			
Width / length / height, incl. TS 7.5	28 mm / 96 mm / 99 mm		
Wire strip length	30 mm		
Approvals	 KEMA 02 ATEX 2114 U		
<b>Technical data</b>	<b>IEC</b>	<b>UL</b>	<b>CSA</b>
	EN 60 947-7-1		EN 60 079-0/-7
Cross section fine-stranded	35–150 mm <sup>2</sup>	2/0 AWG-350 kcmil	35–150 mm <sup>2</sup>
Cross section solid/stranded	35–185 mm <sup>2</sup>		35–185 mm <sup>2</sup>
Rated current	309 A	335/335 A	290/309 A <sup>2)</sup>
Rated voltage	1000 V	600 V	600 V
Rated impulse voltage	8 kV		690 V
Pollution degree	3		
<b>Accessories</b>			
Partition, gray			
Cross connector with screws, insulated	2 pole 3 pole	VB WKN 150 - 2 VB WKN 150 - 3	5 5
	up to 6 pole	VB WKN 150 - 6	5
Cover with warning symbol over 4 blocks	AD VB 28/4 GELB	04.343.5456.8	10

<sup>1)</sup> For maintaining the proper isolation distances, the open side of a feed-through terminal block as well as both sides of a jumper are to be enclosed by partitions <sup>2)</sup> With/without jumper

**Supply set**

Description	Type	Part No.	Std. Pack
Supply set	WKN 70 3D/N/SL/U	57.570.9855.0	1
Supply set	WKN 70 3D/2N/SL/U	57.570.9955.0	1
Supply set	WKN 150/70 3D/N/SL/U	57.597.9855.0	1
Supply set	WKN 150/3D/N/U	57.597.9955.0	1

## Ground blocks with screw connection

### WT 2,5 PE

- Ground block with screw connection for mounting on TS 35
- Nominal cross section 2.5 mm<sup>2</sup>
-  II 2G 2D Ex eb IIC  
EN 60079-0:12+A11:13 / IEC 60079-0:2011 Ed:6.0  
EN 60079-7:07 / IEC 60079-7:2006-07 Ed:4  
Follow the EX installation instructions on page 149
- Connection capacity: 2 wires, equal size  
0.14 – 1.5 mm<sup>2</sup>

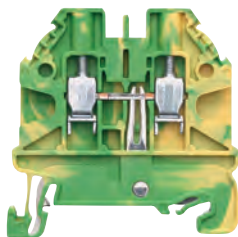

Description	Type	Part No.	Std. Pack
Ground block, green/yellow	WT 2,5 PE	58.503.9055.0	100
<b>General data</b>			
Width / length / height, incl. TS 7.5	5 mm / 48 mm / 48 mm		
Wire strip length	9 mm		
Approvals	IECEx SEV 14.0004 U SEV 14 ATEX 0124 U		
Approvals			
<b>Technical data</b>	<b>IEC</b>	<b>UL</b>	<b>CSA</b>
	EN 60 947-7-2		
Cross section fine-stranded	0.14–4 mm <sup>2</sup>		0.14–4 mm <sup>2</sup>
Cross section solid/stranded	0.14–4 mm <sup>2</sup>		0.14–4 mm <sup>2</sup>
Cross section, AWG	26–12		26–12
Rated current			
Rated voltage	1000 V	600 V	600 V
Rated impulse voltage	8 kV		
Pollution degree	3		
<b>Accessories</b>			
Type			
End plate	AP WT 2,5 - 10	Part No. 07.313.2555.0	Std. Pack 10

### WT 4 PE

- Ground block with screw connection for mounting on TS 35
- Nominal cross section 4 mm<sup>2</sup>
-  II 2G 2D Ex eb IIC  
EN 60079-0:12+A11:13 / IEC 60079-0:2011 Ed:6.0  
EN 60079-7:07 / IEC 60079-7:2006-07 Ed:4  
Follow the EX installation instructions on page 149
- Connection capacity: 2 wires, equal size  
0.14 – 2.5 mm<sup>2</sup>

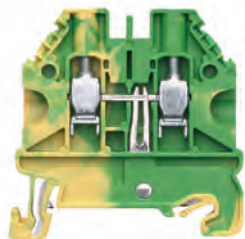

Description	Type	Part No.	Std. Pack
Ground block, green/yellow	WT 4 PE	58.504.9055.0	100
<b>General data</b>			
Width / length / height, incl. TS 7.5	6 mm / 48 mm / 48 mm		
Wire strip length	9 mm		
Approvals	IECEx SEV 14.0004 U SEV 14 ATEX 0124 U		
Approvals			
<b>Technical data</b>	<b>IEC</b>	<b>UL</b>	<b>CSA</b>
	EN 60 947-7-2		
Cross section fine-stranded	0.14–6 mm <sup>2</sup>		0.14–6 mm <sup>2</sup>
Cross section solid/stranded	0.14–6 mm <sup>2</sup>		0.14–6 mm <sup>2</sup>
Cross section, AWG	26–10		26–10
Rated current			
Rated voltage	1000 V	600 V	600 V
Rated impulse voltage	8 kV		
Pollution degree	3		
<b>Accessories</b>			
Type			
End plate	AP WT 2,5 - 10	Part No. 07.313.2555.0	Std. Pack 10

### WT 6 PE

- Ground block with screw connection for mounting on TS 35
- Nominal cross section 6 mm<sup>2</sup>
-  II 2G 2D Ex eb IIC  
EN 60079-0:12+A11:13 / IEC 60079-0:2011 Ed:6.0  
EN 60079-7:07 / IEC 60079-7:2006-07 Ed:4  
Follow the EX installation instructions on page 149
- Connection capacity: 2 wires, equal size  
0.2 – 4 mm<sup>2</sup>

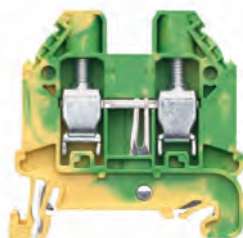



Description	Type	Part No.	Std. Pack
Ground block, green/yellow	WT 6 PE	58.506.9055.0	100
<b>General data</b>			
Width / length / height, incl. TS 7.5	8 mm / 48 mm / 48 mm		
Wire strip length	11 mm		
Approvals	IECEx SEV 14.0004 U SEV 14 ATEX 0124 U		
Approvals			
<b>Technical data</b>	<b>IEC</b>	<b>UL</b>	<b>CSA</b>
	EN 60 947-7-2		
Cross section fine-stranded	0.2–10 mm <sup>2</sup>		0.2–10 mm <sup>2</sup>
Cross section solid/stranded	0.2–10 mm <sup>2</sup>		0.2–10 mm <sup>2</sup>
Cross section, AWG	24–8		24–8
Rated current			
Rated voltage	1000 V	600 V	600 V
Rated impulse voltage	8 kV		
Pollution degree	3		
<b>Accessories</b>			
Type			
End plate	AP WT 2,5 - 10	Part No. 07.313.2555.0	Std. Pack 10

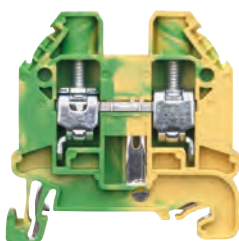

### WT 10 PE

- Ground block with screw connection for mounting on TS 35
- Nominal cross section 10 mm<sup>2</sup>
-  II 2G 2D Ex eb IIC  
EN 60079-0:12+A11:13 / IEC 60079-0:2011 Ed:6.0  
EN 60079-7:07 / IEC 60079-7:2006-07 Ed:4  
Follow the EX installation instructions on page 149
- Connection capacity: 2 wires, equal size  
0.5 – 6 mm<sup>2</sup>





Description	Type	Part No.	Std. Pack
Ground block, green/yellow	WT 10 PE	58.510.9055.0	50
<b>General data</b>			
Width / length / height, incl. TS 7.5	10 mm / 48 mm / 48 mm		
Wire strip length	13 mm	IECEX SEV 14.0004 U	
Approvals	 ATEX IECEx SEV 14 ATEX 0124 U		
<b>Technical data</b>	<b>IEC</b>	<b>UL</b>	<b>CSA</b>
	EN 60 947-7-2		
Cross section fine-stranded	0.5–16 mm <sup>2</sup>		0.5–16 mm <sup>2</sup>
Cross section solid/stranded	0.5–16 mm <sup>2</sup>		0.5–16 mm <sup>2</sup>
Cross section, AWG		20–6	20–6
Rated current			
Rated voltage	1000 V	600 V	600 V
Rated impulse voltage	8 kV		
Pollution degree	3		
<b>Accessories</b>			
	Type	Part No.	Std. Pack
End plate	AP WT 2,5 - 10	07.313.2555.0	10

### WT 16 PE

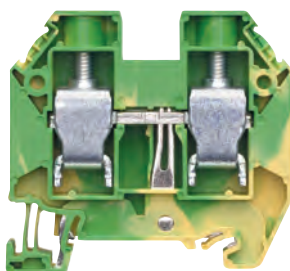
- Ground block with screw connection for mounting on TS 35
- Nominal cross section 16 mm<sup>2</sup>
-  II 2G 2D Ex eb IIC  
EN 60079-0:12+A11:13 / IEC 60079-0:2011 Ed:6.0  
EN 60079-7:07 / IEC 60079-7:2006-07 Ed:4  
Follow the EX installation instructions on page 149
- Connection capacity: 2 wires, equal size  
2.5 – 10 mm<sup>2</sup>





Description	Type	Part No.	Std. Pack
Ground block, green/yellow	WT 16 PE	58.516.9055.0	100
<b>General data</b>			
Width / length / height, incl. TS 7.5	12 mm / 58 mm / 54 mm		
Wire strip length	15 mm	IECEX SEV 14.0004 U	
Approvals	 ATEX IECEx SEV 14 ATEX 0124 U		
<b>Technical data</b>	<b>IEC</b>	<b>UL</b>	<b>CSA</b>
	EN 60 947-7-2		
Cross section fine-stranded	4–25 mm <sup>2</sup>		4–25 mm <sup>2</sup>
Cross section solid/stranded	1.5–25 mm <sup>2</sup>		1.5–25 mm <sup>2</sup>
Cross section, AWG		16–4	16–4
Rated current			
Rated voltage	1000 V	600 V	600 V
Rated impulse voltage	8 kV		
Pollution degree	3		
<b>Accessories</b>			
	Type	Part No.	Std. Pack
End plate	AP WT 16	07.313.2755.0	10

## Ground blocks with screw connection

### WKN 35 SL/U

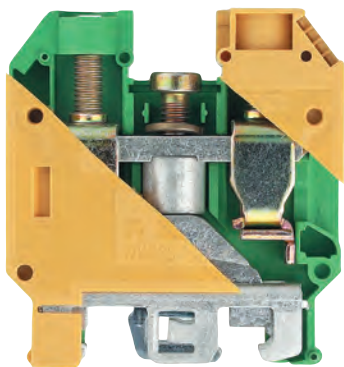
- Ground block with screw connection for mounting on TS 35 and TS 32
- Nominal cross section 35 mm<sup>2</sup>
- Ex e I/II  II 2GD IM2  
Follow the EX installation instructions on page 149
- Enclosed design



Description	Type	Part No.	Std. Pack
Ground block, green/yellow	WKN 35 SL/U	57.535.9055.0	20
<b>General data</b>			
Width / length / height, incl. TS 7.5	16 mm / 63 mm / 68 mm		
Wire strip length	20 mm		
Approvals	 KEMA 02 ATEX 2114 U		
<b>Technical data</b>			
	<b>IEC</b>	<b>UL</b>	<b>CSA</b>
	EN 60 947-7-2		EN 60 079-0/-7
Cross section fine-stranded	10–35 mm <sup>2</sup>		10–35 mm <sup>2</sup>
Cross section solid/stranded	10–50 mm <sup>2</sup>		10–50 mm <sup>2</sup>
Cross section, AWG		10–2	10–2
Rated current			
Rated voltage	800 V	600 V	600 V
Rated impulse voltage	8 kV		
Pollution degree	3		

### WKN 70 SL/U

- Ground block with screw connection for mounting on TS 35 and TS 32
- Nominal cross section 70 mm<sup>2</sup>
- Ex e I/II  II 2GD IM2  
Follow the EX installation instructions on page 149
- Enclosed design

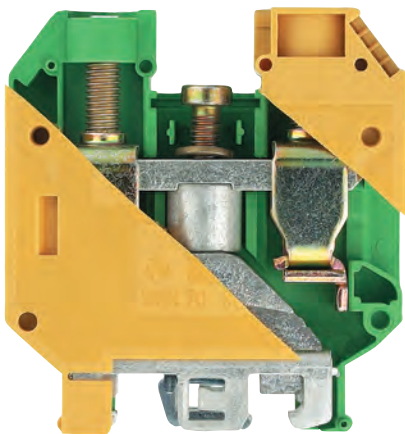

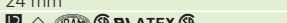
Description	Type	Part No.	Std. Pack
Ground block, green/yellow	WKN 70 SL/U	57.570.9055.0	20
<b>General data</b>			
Width / length / height, incl. TS 7.5	24 mm / 75 mm / 81 mm		
Wire strip length	24 mm		
Approvals	 KEMA 02 ATEX 2114 U		
<b>Technical data</b>			
	<b>IEC</b>	<b>UL</b>	<b>CSA</b>
	EN 60 947-7-2		EN 60 079-0/-7
Cross section fine-stranded	10–70 mm <sup>2</sup>		10–70 mm <sup>2</sup>
Cross section solid/stranded	16–95 mm <sup>2</sup>		16–95 mm <sup>2</sup>
Cross section, AWG		6–2/0	6–2/0
Rated current			
Rated voltage	800 V	600 V	600 V
Rated impulse voltage	8 kV		
Pollution degree	3		

### 9700 A/35 E S 35

- Ground block with screw connection for mounting on TS 35
- Nominal cross section 35 mm<sup>2</sup>

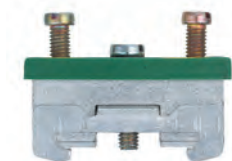

Description	Type	Part No.	Std. Pack
Ground block, green/yellow	9700 A/35 E S 35	Z2.302.0621.0	25
<b>General data</b>			
Width / length / height, incl. TS 7.5	17 mm / 56 mm / 35 mm		
Wire strip length			
Approvals	VDE		
<b>Technical data</b>	<b>IEC</b>	<b>UL</b>	<b>CSA</b>
	EN 60 947-7-2		
Cross section fine-stranded	35 mm <sup>2</sup>		
Cross section solid/stranded	50 mm <sup>2</sup>		
Cross section, AWG	8-2		
Rated current			
Rated voltage	600 V		
Rated impulse voltage			
Pollution degree			

### 9700 A/70 E S 35

- Ground block with screw connection for mounting on TS 35
- Nominal cross section 70 mm<sup>2</sup>



Description	Type	Part No.	Std. Pack
Ground block, green/yellow	9700 A/70 E S 35	Z2.302.0421.0	10
<b>General data</b>			
Width / length / height, incl. TS 7.5	25 mm / 57 mm / 57 mm		
Wire strip length			
Approvals	VDE		
<b>Technical data</b>	<b>IEC</b>	<b>UL</b>	<b>CSA</b>
	EN 60 947-7-2		
Cross section fine-stranded	70 mm <sup>2</sup>		
Cross section solid/stranded	120 mm <sup>2</sup>		
Cross section, AWG	6-2/0		6-2/0
Rated current			
Rated voltage	600 V		
Rated impulse voltage			
Pollution degree			

## Duo feed-through and duo-ground blocks with screw connection

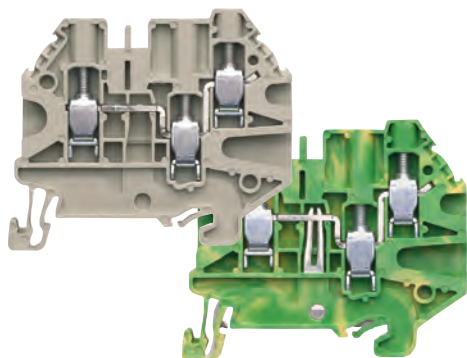

### WT 4 D1/2 | WT 4 D 1/2 PE

- Duo feed-through block / duo-ground block with screw connection for mounting on TS 35
- Nominal cross section 4 mm<sup>2</sup>
-  II 2G 2D Ex eb IIC  
EN 60079-0:12+A11:13 / IEC 60079-0:2011 Ed:6.0  
EN 60079-7:07 / IEC 60079-7:2006-07 Ed:4  
Follow the EX installation instructions on page 149
- Max. electrical data: 41 A/6 mm<sup>2</sup>
- Connection capacity: 2 wires, equal size 0.14 – 2.5 mm<sup>2</sup>



Description	Type	Part No.	Std. Pack
Duo feed-through block, gray	WT 4 D1/2	58.504.5055.0	100
Duo feed-through block, blue	WT 4 D1/2 BL	58.504.5055.6	100
Duo-ground block, green/yellow	WT 4 D1/2 PE	58.504.9355.0	100

  

General data				
Width / length / height, incl. TS 7.5	6 mm / 56 mm / 50 mm			
Wire strip length	9 mm			IECEx SEV 14.0004 U
Approvals				SEV 14 ATEX 0124 U
Technical data	IEC	UL	CSA	
	EN 60 947-7-1			
Cross section fine-stranded	0.14–6 mm <sup>2</sup>			0.14–6 mm <sup>2</sup>
Cross section solid/stranded	0.14–6 mm <sup>2</sup>			0.14–6 mm <sup>2</sup>
Cross section, AWG			26–10	26–10
Rated current	32 A	30 A	30 A	32 A
Rated voltage	500 V	300 V	300 V	550 V
Rated impulse voltage	6 kV			
Pollution degree	3			

Accessories				
	Type	Part No.	Std. Pack	
End plate	AP WT 4 D1/2	07.313.2955.0	10	
Partition	TW WT 4 E	07.313.2855.0	10	
Cross connector	2 pole	IVB WKF 4-2	Z7.261.1227.0	10
	3 pole	IVB WKF 4-3	Z7.261.1327.0	10
	4 pole	IVB WKF 4-4	Z7.261.1427.0	10
	5 pole	IVB WKF 4-5	Z7.261.1527.0	10
	10 pole	IVB WKF 4-10	Z7.261.2027.0	10



### WT 4 D2/2 | WT 4 D2/2 PE

- Duo feed-through block / duo-ground block with screw connection for mounting on TS 35
- Nominal cross section 4 mm<sup>2</sup>
-  II 2G 2D Ex eb IIC  
EN 60079-0:12+A11:13 / IEC 60079-0:2011 Ed:6.0  
EN 60079-7:07 / IEC 60079-7:2006-07 Ed:4  
Follow the EX installation instructions on page 149
- Max. electrical data: 41 A/6 mm<sup>2</sup>
- Connection capacity: 2 wires, equal size 0.14 – 2.5 mm<sup>2</sup>

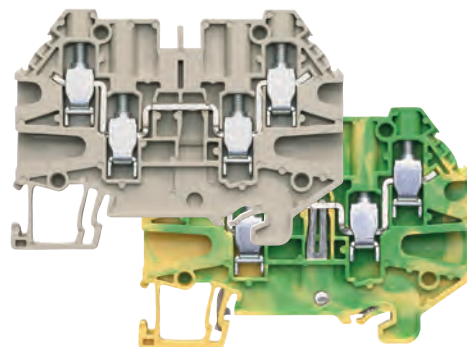

Description	Type	Part No.	Std. Pack
Duo feed-through block, gray	WT 4 D2/2	58.504.5155.0	100
Duo feed-through block, blue	WT 4 D2/2 BLAU	58.504.5155.6	100
Duo-ground block, green/yellow	WT 4 D2/2 PE	58.504.9155.0	100

  

General data				
Width / length / height, incl. TS 7.5	6 mm / 68 mm / 50 mm			
Wire strip length	9 mm			IECEx SEV 14.0004 U
Approvals				SEV 14 ATEX 0124 U
Technical data	IEC	UL	CSA	
	EN 60 947-7-1			
Cross section fine-stranded	0.14–6 mm <sup>2</sup>			0.14–6 mm <sup>2</sup>
Cross section solid/stranded	0.14–6 mm <sup>2</sup>			0.14–6 mm <sup>2</sup>
Cross section, AWG			26–10	26–10
Rated current	32 A	30 A	30 A	32 A
Rated voltage	500 V	300 V	300 V	440 V
Rated impulse voltage	6 kV			
Pollution degree	3			



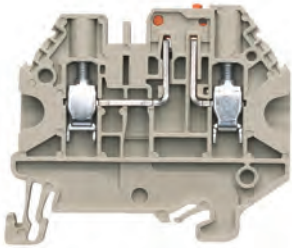

Accessories				
	Type	Part No.	Std. Pack	
End plate	AP WT 4 D2/2	07.313.3155.0	10	
Partition	TW WT 4 E	07.313.2855.0	10	
Cross connector	2 pole	IVB WKF 4-2	Z7.261.1227.0	10
	3 pole	IVB WKF 4-3	Z7.261.1327.0	10
	4 pole	IVB WKF 4-4	Z7.261.1427.0	10
	5 pole	IVB WKF 4-5	Z7.261.1527.0	10
	10 pole	IVB WKF 4-10	Z7.261.2027.0	10

## Knife edge disconnect and fuse blocks with screw connection

WT 2,5 TKM...		Description	Type	Part No.	Std. Pack
<ul style="list-style-type: none"> <li>• Knife edge disconnect block for mounting on TS 35</li> <li>• Nominal cross section 2,5 mm<sup>2</sup></li> <li>• Connection capacity: 2 wires, equal size 0,14 – 1,5 mm<sup>2</sup></li> </ul>		Knife edge disconnect block, gray	WT 2,5 TKM	58.503.2055.0	100
		Knife edge disconnect block, blue with 2 test bolts, gray	WT 2,5 TKM BL	58.503.2055.6	100
		Feed-through block, identically-shaped, gray	WT 2,5 TKM D	58.503.2155.0	100
		Feed-through block, identically-shaped, blue	WT 2,5 TKM D BL	58.503.2155.6	100
<b>General data</b>					
Width / length / height, incl. TS 7.5		5 mm / 56 mm / 50 mm			
Wire strip length		9 mm			
Approvals					
<b>Technical data</b>					
		<b>IEC</b>	<b>UL</b>	<b>CSA</b>	
Cross section fine-stranded		0.14–4 mm <sup>2</sup>	pending	pending	
Cross section solid/stranded		0.14–4 mm <sup>2</sup>			
Cross section, AWG					
Rated current		20 A			
Rated voltage		500 V			
Rated impulse voltage		6 kV			
Pollution degree		3			
<b>Accessories</b>					
		Type		Part No.	Std. Pack
End plate		AP WT 4 D1/2		07.313.2955.0	10
Partition		TW WT 4 E		07.313.2855.0	10
Cross connector		2 pole	IVB WKF 2,5-2	Z7.280.6227.0	10
		5 pole	IVB WKF 2,5-5	Z7.280.6527.0	10
		10 pole	IVB WKF 2,5-10	Z7.280.7027.0	10
			IVB WKF 2,5-20	Z7.280.8027.0	10

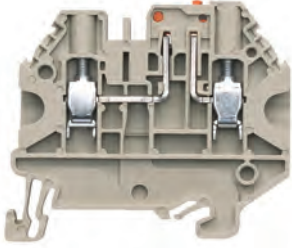
WT 4 TKM...		Description	Type	Part No.	Std. Pack
<ul style="list-style-type: none"> <li>• Knife edge disconnect block for mounting on TS 35</li> <li>• Nominal cross section 4 mm<sup>2</sup></li> <li>• Connection capacity: 2 wires, equal size 0,14 – 2,5 mm<sup>2</sup></li> </ul>		Knife edge disconnect block, gray	WT 4 TKM	58.504.2055.0	100
		Knife edge disconnect block, blue with 2 test bolts, gray	WT 4 TKM BL	58.504.2055.6	100
			WT 4 TKM P	58.504.2355.0	100
		<b>General data</b>			
Width / length / height, incl. TS 7.5		6 mm / 56 mm / 50 mm			
Wire strip length		9 mm			
Approvals					
<b>Technical data</b>					
		<b>IEC</b>	<b>UL</b>	<b>CSA</b>	
Cross section fine-stranded		0.14–6 mm <sup>2</sup>			
Cross section solid/stranded		0.14–6 mm <sup>2</sup>			
Cross section, AWG			26–10	26–10	
Rated current		24 A	16 A	16 A	
Rated voltage		500 V	300 V	300 V	
Rated impulse voltage		6 kV			
Pollution degree		3			
<b>Accessories</b>					
		Type		Part No.	Std. Pack
End plate		AP WT 4 D1/2		07.313.2955.0	10
Partition		TW WT 4 E		07.313.2855.0	10
Cross connector		2 pole	IVB WKF 4-2	Z7.261.1227.0	10
		5 pole	IVB WKF 4-5	Z7.261.1527.0	10
		10 pole	IVB WKF 4-10	Z7.261.2027.0	10

  

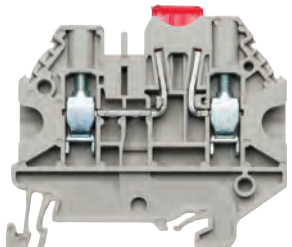

WT 4 FSI		Description	Type	Part No.	Std. Pack		
<ul style="list-style-type: none"> <li>• Fuse block for automobile fuses (mini) for mounting on TS 35</li> <li>• Nominal cross section 4 mm<sup>2</sup></li> <li>• Connection capacity: 2 wires, equal size 0,14 – 2,5 mm<sup>2</sup></li> </ul> <p><sup>1)</sup> Observe the derating curve, available in our e-catalog at <a href="https://eshop.wieland-electric.com">https://eshop.wieland-electric.com</a></p> <p><sup>2)</sup> determined by the fuse inserted</p>		Fuse block, gray	WT 4 FSI	58.504.4155.0	100		
		<b>General data</b>					
		Width / length / height, incl. TS 7.5		6 mm / 56 mm / 50 mm			
		Wire strip length		9 mm			
Approvals							
<b>Technical data</b>							
		<b>IEC</b>	<b>UL</b>	<b>CSA</b>			
Cross section fine-stranded		0.14–6 mm <sup>2</sup>	pending	pending			
Cross section solid/stranded		0.14–6 mm <sup>2</sup>					
Cross section, AWG							
Rated current		max. 20 A <sup>1)</sup>					
Rated voltage		<sup>2)</sup>					
Rated impulse voltage		6 kV					
Pollution degree		3					
<b>Accessories</b>							
		Type		Part No.	Std. Pack		
End plate		AP WT 4 D1/2		07.313.2955.0	10		
Partition		TW WT 4 E		07.313.2855.0	10		
Cross connector		2 pole	IVB WKF 4-2	Z7.261.1227.0	10		
		5 pole	IVB WKF 4-5	Z7.261.1527.0	10		
		10 pole	IVB WKF 4-10	Z7.261.2027.0	10		

## Multi-tier blocks with screw connection

### WKN 2,5 E/U

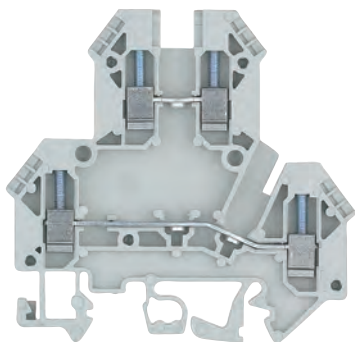
- Multi-tier block for mounting on TS 35 and TS 32
- Nominal cross section 2.5 mm<sup>2</sup>
- Ex e I/II  II 2GD IM2  
Follow the EX installation instructions on page 149





Description	Type	Part No.	Std. Pack
Multi-tier block, gray	WKN 2,5 E/U	57.403.7055.0	100
<b>General data</b>			
Width / length / height, incl. TS 7.5	5 mm / 66 mm / 64 mm		
Wire strip length	8 mm		
Approvals			
<b>Technical data</b>	<b>IEC</b>	<b>UL</b>	<b>CSA</b>
	EN 60 947-7-1		
Cross section fine-stranded	0.5–2.5 mm <sup>2</sup>		
Cross section solid/stranded	0.5–4 mm <sup>2</sup>		
Cross section, AWG		22–12	24–12
Rated current	24 A	20 A	25 V 20 A
Rated voltage	500 V	600 V	600 V 600 V
Rated impulse voltage	6 A		
Pollution degree	3		

### WKN 2,5 E/U/VB

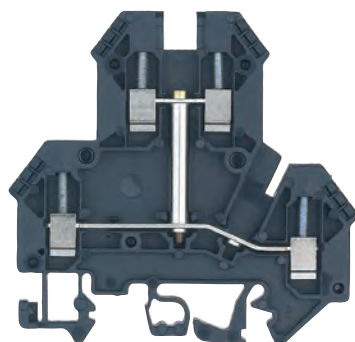
- Multi-tier block, vertically jumpered, with screw connection for mounting on TS 35 and TS 32
- Nominal cross section 2.5 mm<sup>2</sup>
- Ex e I/II  II 2GD IM2  
Follow the EX installation instructions on page 149



Description	Type	Part No.	Std. Pack
Multi-tier block, black	WKN 2,5 E/U/VB	57.403.6955.1	100
<b>General data</b>			
Width / length / height, incl. TS 7.5	5 mm / 66 mm / 64 mm		
Wire strip length	8 mm		
Approvals			
<b>Technical data</b>	<b>IEC</b>	<b>UL</b>	<b>CSA</b>
	EN 60 947-7-1		
Cross section fine-stranded	0.5–2.5 mm <sup>2</sup>		
Cross section solid/stranded	0.5–4 mm <sup>2</sup>		
Cross section, AWG		22–12	24–12
Rated current	24 A	20 A	25 A 20 A
Rated voltage	500 V	600 V	600 V 600 V
Rated impulse voltage	6 A		
Pollution degree	3		

## Accessories for selos WKN 2,5 E/U...





Accessories	Type	Part No.	Std. Pack
End plate	gray APN 2,5 E	07.312.1755.0	10
Partition	gray TWN 2,5 E	07.312.1855.0	10
Cross connector with screws, insulated	2 pole IVB WK 2,5 - 2	Z7.280.2227.0	10
	3 pole IVB WK 2,5 - 3	Z7.280.2327.0	10
	up to 12 pole IVB WK 2,5 - 12	Z7.280.3227.0	10
Partition plate with marking facility	yellow TS 2,5 GELB	07.311.2053.8	10
Single cover with marking facility	yellow AD VB 2,5 GELB	04.326.2053.8	10
Cover with warning symbol over 4 blocks		04.343.4756.8	10

### WT 4 E

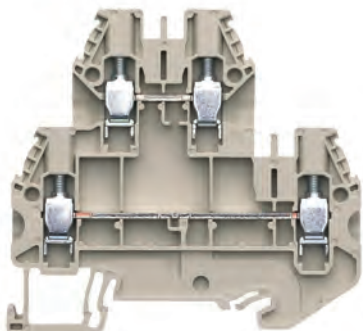
- Multi-tier block for mounting on TS 35
- Nominal cross section 4 mm<sup>2</sup>
-  II 2G 2D Ex eb IIC  
EN 60079-0:12+A11:13 / IEC 60079-0:2011 Ed:6.0  
EN 60079-7:07 / IEC 60079-7:2006-07 Ed:4  
Follow the EX installation instructions on page 149
- Connection capacity: 2 wires, equal size  
0.14 – 2.5 mm<sup>2</sup>





Description	Type	Part No.	Std. Pack
Multi-tier block, gray	WT 4 E	58.504.7055.0	100
Multi-tier block, blue	WT 4 E BL	58.504.7055.6	100
<b>General data</b>			
Width / length / height, incl. TS 7.5	6 mm / 72 mm / 67 mm		
Wire strip length	9 mm	IECEx SEV 14.0004 U	
Approvals	 ATEX IECEx SEV 14 ATEX 0124 U		
<b>Technical data</b>	<b>IEC</b>	<b>UL</b>	<b>CSA</b>
			
	EN 60 947-7-1		
Cross section fine-stranded	0.14–6 mm <sup>2</sup>		0.14–6 mm <sup>2</sup>
Cross section solid/stranded	0.14–6 mm <sup>2</sup>		0.14–6 mm <sup>2</sup>
Cross section, AWG	26–10	26–10	
Rated current	32 A	30 A	30 A
Rated voltage	800 V	300 V	550 V
Rated impulse voltage	8 kV	300 V	
Pollution degree	3		
<b>Accessories</b>			
	Type	Part No.	Std. Pack
End plate	AP WT 4 E	07.313.3355.0	10
Partition	TW WT 4 E	07.313.2855.0	10
Cross connector	2 pole IVB WKF 4-2	Z7.261.1227.0	10
	3 pole IVB WKF 4-3	Z7.261.1327.0	10
	4 pole IVB WKF 4-4	Z7.261.1427.0	10
	5 pole IVB WKF 4-5	Z7.261.1527.0	10
	10 pole IVB WKF 4-10	Z7.261.2027.0	10

### WT 4 E VB

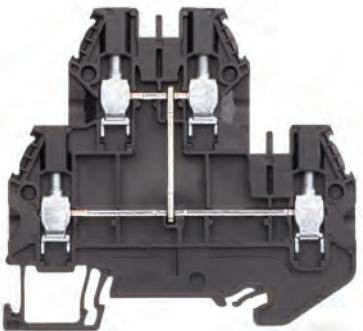
- Multi-tier block, vertically jumpered, with screw connection for mounting on TS 35
- Nominal cross section 4 mm<sup>2</sup>
-  II 2G 2D Ex eb IIC  
EN 60079-0:12+A11:13 / IEC 60079-0:2011 Ed:6.0  
EN 60079-7:07 / IEC 60079-7:2006-07 Ed:4  
Follow the EX installation instructions on page 149
- Connection capacity: 2 wires, equal size  
0.14 – 2.5 mm<sup>2</sup>





Description	Type	Part No.	Std. Pack
Multi-tier block, black	WT 4 E VB	58.504.6955.1	100
<b>General data</b>			
Width / length / height, incl. TS 7.5	6 mm / 72 mm / 67 mm		
Wire strip length	9 mm	IECEx SEV 14.0004 U	
Approvals	 ATEX IECEx SEV 14 ATEX 0124 U		
<b>Technical data</b>	<b>IEC</b>	<b>UL</b>	<b>CSA</b>
			
	EN 60 947-7-1		
Cross section fine-stranded	0.14–6 mm <sup>2</sup>		0.14–6 mm <sup>2</sup>
Cross section solid/stranded	0.14–6 mm <sup>2</sup>		0.14–6 mm <sup>2</sup>
Cross section, AWG	26–10	26–10	
Rated current	32 A	30 A	30 A
Rated voltage	800 V	300 V	550 V
Rated impulse voltage	8 kV	300 V	
Pollution degree	3		
<b>Accessories</b>			
	Type	Part No.	Std. Pack
End plate	AP WT 4 E	07.313.3355.0	10
Partition	TW WT 4 E	07.313.2855.0	10
Cross connector	2 pole IVB WKF 4-2	Z7.261.1227.0	10
	3 pole IVB WKF 4-3	Z7.261.1327.0	10
	4 pole IVB WKF 4-4	Z7.261.1427.0	10
	5 pole IVB WKF 4-5	Z7.261.1527.0	10
	10 pole IVB WKF 4-10	Z7.261.2027.0	10

### WT 4 E PE

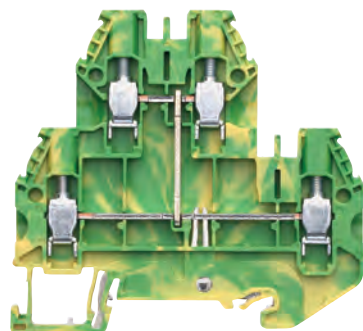
- Multi-tier ground block with screw connection for mounting on TS 35
- Nominal cross section 4 mm<sup>2</sup>
-  II 2G 2D Ex eb IIC  
EN 60079-0:12+A11:13 / IEC 60079-0:2011 Ed:6.0  
EN 60079-7:07 / IEC 60079-7:2006-07 Ed:4  
Follow the EX installation instructions on page 149
- Connection capacity: 2 wires, equal size  
0.14 – 2.5 mm<sup>2</sup>



Description	Type	Part No.	Std. Pack
Multi-tier ground block, green/yellow	WT 4 E PE	58.504.9255.0	100
<b>General data</b>			
Width / length / height, incl. TS 7.5	6 mm / 72 mm / 67 mm		
Wire strip length	9 mm	IECEx SEV 14.0004 U	
Approvals	 ATEX IECEx SEV 14 ATEX 0124 U		
<b>Technical data</b>	<b>IEC</b>	<b>UL</b>	<b>CSA</b>
			
	EN 60 947-7-2		
Cross section fine-stranded	0.14–6 mm <sup>2</sup>		0.14–6 mm <sup>2</sup>
Cross section solid/stranded	0.14–6 mm <sup>2</sup>		0.14–6 mm <sup>2</sup>
Cross section, AWG	26–10		
Rated current			
Rated voltage	800 V	300 V	
Rated impulse voltage	8 kV		
Pollution degree	3		
<b>Accessories</b>			
	Type	Part No.	Std. Pack
End plate	AP WT 4 E	07.313.3355.0	10

## Specialty function blocks with screw connection

### WT 4 E...

- Function block with screw connection for mounting on TS 35
- Nominal cross section 4 mm<sup>2</sup>
- Connection capacity: 2 wires, equal size 0.14 – 2.5 mm<sup>2</sup>

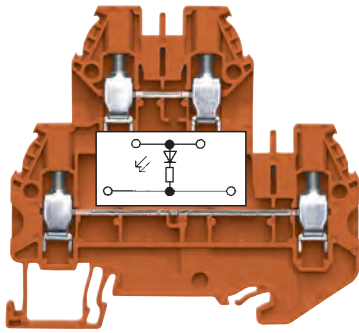

Description	Type	Part No.	Std. Pack
Function block, orange	WT 4 E...	58.504.XX55.9	100
<b>General data</b>			
Width / length / height, incl. TS 7.5	6 mm / 72 mm / 67 mm		
Wire strip length	9 mm		
Approvals			
<b>Technical data</b>		<b>IEC</b>	<b>UL</b> <b>CSA</b>
	EN 60 947-7-1/-2		
Cross section fine-stranded	0.14–6 mm <sup>2</sup>		
Cross section solid/stranded	0.14–6 mm <sup>2</sup>		
Cross section, AWG	26–10		26–10
Rated current			
Rated voltage			
Rated impulse voltage			
Pollution degree			
<b>Accessories</b>		Type	Part No.
End plate, gray	AP WT 4 E	07.313.3355.0	10

### Examples of functions

The multi-tier block is available on request as a function block for a wide variety of switching tasks.

58.504.8355.9

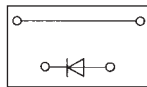

58.504.8055.9  
with inverted diode

400 V  
1 A/1000 V

58.504.7455.9 LED red

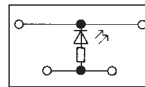

24 V DC  
R = 4,7 K  
0,4 W

58.504.8255.9

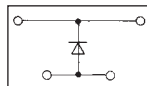

58.504.8155.9  
with inverted diode

400 V  
1 A/1000 V

58.504.7955.9

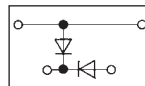

58.504.8855.9  
with inverted diodes

1 A/400 V

58.504.7255.9 LED red

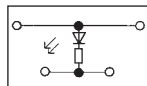

24 V DC  
R = 4,7 K  
0,4 W

58.504.8755.9 LED green

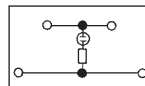

58.504.7355.9

U = 100-500 V



## Three-tier-/Initiator blocks with screw connection

**WK 2,5-3 D/U**

- Multi-tier block for mounting on TS 35 and TS 32
- Nominal cross section 2.5 mm<sup>2</sup>

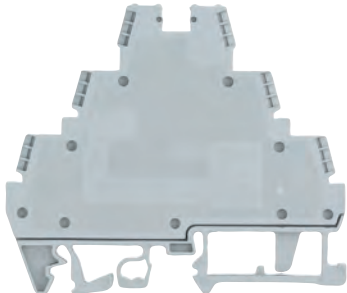

WK 2,5 - 3 D/U-NGN

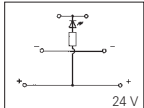

WK 2,5 - 3 D/U-PGN

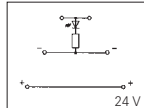

Description	Type	Part No.	Std. Pack
Multi-tier block, gray	WK 2,5 - 3 D/U	57.503.8855.0	50
Multi-tier bl., LED (green) betw. signal and +	WK 2,5 - 3 D/U-NGN	57.503.8955.0	50
Multi-tier bl., LED (green) betw. signal and -	WK 2,5 - 3 D/U-PGN	57.503.9055.0	50

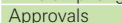
General data				
Width / length / height, incl. TS 7.5	6 mm / 79 mm / 69 mm			
Wire strip length	7 mm			
Approvals				
Technical data		IEC	UL	CSA
		EN 60 947-7-1		
Cross section fine-stranded	0.5–2.5 mm <sup>2</sup>			
Cross section solid/stranded	0.5–4 mm <sup>2</sup>			
Cross section, AWG		22–12	22–12	
Rated current	24 A	25 A	25 A	
Rated voltage	400 V*	300 V*	300 V*	
Rated impulse voltage	6 kV			
Pollution degree	3			

Accessories		Type	Part No.	Std. Pack
Partition, gray		TW 2,5 - 3 D/U	07.312.1255.0	50

**WK 2,5-3 D/SL**

- Multi-tier block for mounting on TS 35
- Nominal cross section 2,5 mm<sup>2</sup>

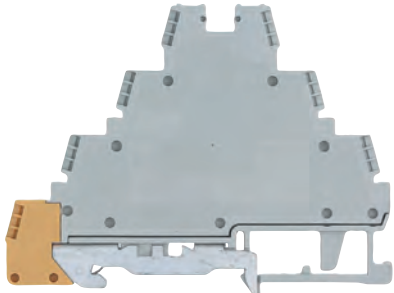

WK 2,5 - 3 D SL-NGN

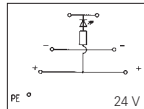

WK 2,5 - 3 D SL-PGN

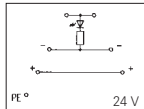

Description	Type	Part No.	Std. Pack
Multi-tier block, gray	WK 2,5 - 3 D SL	56.503.8355.0	50
Multi-tier bl., LED (green) betw. signal and +	WK 2,5 - 3 D SL-NGN	56.503.8455.0	50
Multi-tier bl., LED (green) betw. signal and -	WK 2,5 - 3 D SL-PGN	56.503.8555.0	50

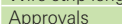
General data				
Width / length / height, incl. TS 7.5	6 mm / 79 mm / 69 mm			
Wire strip length	7 mm			
Approvals				
Technical data		IEC	UL	CSA
		EN 60 947-7-1		
Cross section fine-stranded	0.5–2.5 mm <sup>2</sup>			
Cross section solid/stranded	0.5–4 mm <sup>2</sup>			
Cross section, AWG		22–12	22–12	
Rated current	24 A	25 A	25 A	
Rated voltage	400 V*	300 V*	300 V*	
Rated impulse voltage	6 kV			
Pollution degree	3			

Accessories		Type	Part No.	Std. Pack
Partition, gray		TW 2,5 - 3 D/U	07.312.1255.0	50

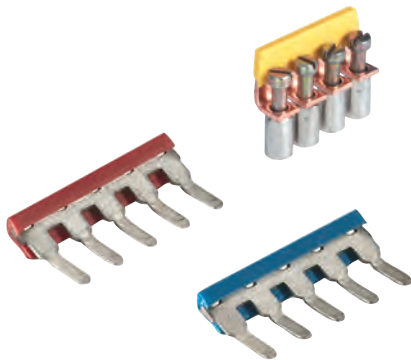

## Accessories for selos WK 2,5-3 D/...

- The use of cross connectors (jumper combs), requires partitions in order to maintain the air and creepage distances.
- \* 24 V~ with LED

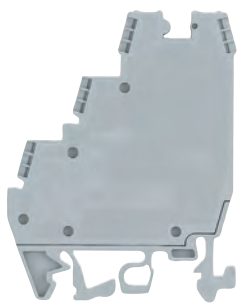

Accessories	Type	Part No.	Std. Pack	
Cross connector with screws, insulated, for upper level	2 pole 3 pole up to 12 pole	IVB WK/3D-02 IVB WK/3D-03 IVB WK/3D-12	Z7.270.0227.0 Z7.270.0327.0 Z7.270.1227.0	10 10 10
Jumper comb, angled, insulated (red), for lower level	2 pole 3 pole up to 12 pole	IVB WK 2,5-K-2 ROT IVB WK 2,5-K-3 ROT IVB WK 2,5-K-12 ROT	Z7.267.0227.5 Z7.267.0327.5 Z7.267.1227.5	10 10 10
Jumper comb, angled, insulated (blue), for lower level	2 pole 3 pole up to 12 pole	IVB WK 2,5-K-2 BLAU IVB WK 2,5-K-3 BLAU IVB WK 2,5-K-12 BLAU	Z7.267.0227.6 Z7.267.0327.6 Z7.267.1227.6	10 10 10

## Initiator blocks with screw connection

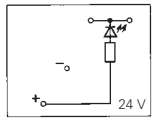

WK 2,5-4 KI/U		Description	Type	Part No.	Std. Pack
<ul style="list-style-type: none"> <li>Initiator block with screw connection for mounting on TS 35 and TS 32</li> <li>Nominal cross section 2.5 mm<sup>2</sup></li> </ul> 		Initiator block, gray	WK 2,5 - 4 KI/U	57.503.7855.0	100
		Multi-tier bl., LED (green) betw. signal and +	WK 2,5 - 4 KI/U-NGN	57.503.7955.0	100
		Multi-tier bl., LED (green) betw. signal and -	WK 2,5 - 4 KI/U-PGN	57.503.8055.0	100
<b>General data</b>					
Width / length / height, incl. TS 7.5		6 mm / 53 mm / 69 mm			
Wire strip length		7 mm			
Approvals					
<b>Technical data</b>					
		<b>IEC</b>	<b>UL</b>	<b>CSA</b>	
		EN 60 947-7-1			
		DIN VDE 0611 T1			
Cross section fine-stranded		0.5–2.5 mm <sup>2</sup>			
Cross section solid/stranded		0.5–4 mm <sup>2</sup>			
Cross section, AWG				22–12	
Rated current		24 A	25 A	25 A	
Rated voltage		250 V*	300 V*	300 V*	
Rated impulse voltage		4 kV			
Pollution degree		3			
<b>Accessories</b>					
		Type	Part No.	Std. Pack	
		Partition, gray	TW 2,5 - 4 K/U	07.312.0555.0	10

WK 2,5 - 4 KI/U-NGN

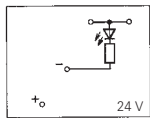

WK 2,5 - 4 KI/U-PGN

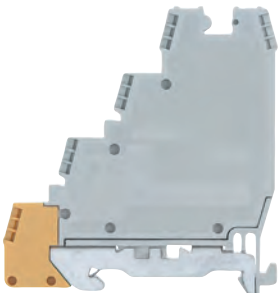

WK 2,5-4 KI/SL		Description	Type	Part No.	Std. Pack
<ul style="list-style-type: none"> <li>Initiator block with screw connection for mounting on TS 35</li> <li>Nominal cross section 2.5 mm<sup>2</sup></li> </ul> 		Initiator block, gray	WK 2,5 - 4 KI SL	56.503.7355.0	100
		Multi-tier bl., LED (green) betw. signal and +	WK 2,5 - 4 KI SL-NGN	56.503.7455.0	100
		Multi-tier bl., LED (green) betw. signal and -	WK 2,5 - 4 KI SL-PGN	56.503.7555.0	100
		Multi-tier bl., LED (red) betw. signal and -	WK 2,5 - 4 KI SL-PRT	56.503.7655.0	100
<b>General data</b>					
Width / length / height, incl. TS 7.5		6 mm / 64 mm / 69 mm			
Wire strip length		7 mm			
Approvals					
<b>Technical data</b>					
		<b>IEC</b>	<b>UL</b>	<b>CSA</b>	
		EN 60 947-7-1			
		DIN VDE 0611 T1			
Cross section fine-stranded		0.5–2.5 mm <sup>2</sup>			
Cross section solid/stranded		0.5–4 mm <sup>2</sup>			
Cross section, AWG				22–12	
Rated current		24 A	25 A	25 A	
Rated voltage		250 V*	300 V*	300 V*	
Rated impulse voltage		4 kV			
Pollution degree		3			
<b>Accessories</b>					
		Type	Part No.	Std. Pack	
		Partition, gray	TW 2,5 - 4 K/U	07.312.0555.0	10

WK 2,5 - 4 KI SL-NGN

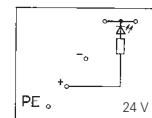

WK 2,5 - 4 KI SL-PGN  
WK 2,5 - 4 KI SL-PRT

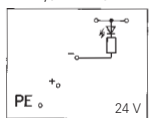

## Accessories for selos WK 2,5-4 KI/...

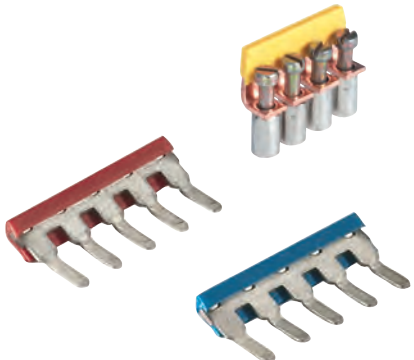
<ul style="list-style-type: none"> <li>The use of cross connectors (jumper combs), requires partitions in order to maintain the air and creepage distances.</li> <li>* 24 V- with LED</li> </ul> 	<b>Accessories</b>		Type	Part No.	Std. Pack
	Cross connector with screws, insulated, for upper level	2 pole	IVB WK/3D-02	Z7.270.0227.0	10
	3 pole	IVB WK/3D-03	Z7.270.0327.0	10	
	up to 12 pole	IVB WK/3D-12	Z7.270.1227.0	10	
Jumper comb, angled, insulated (red), for lower level	2 pole	IVB WK 2,5-K-2 ROT	Z7.267.0227.5	10	
	3 pole	IVB WK 2,5-K-3 ROT	Z7.267.0327.5	10	
	up to 12 pole	IVB WK 2,5-K-12 ROT	Z7.267.1227.5	10	
Jumper comb, angled, insulated (blue), for lower level	2 pole	IVB WK 2,5-K-2 BLAU	Z7.267.0227.6	10	
	3 pole	IVB WK 2,5-K-3 BLAU	Z7.267.0327.6	10	
	up to 12 pole	IVB WK 2,5-K-12 BLAU	Z7.267.1227.6	10	

## Initiator blocks with screw connection

Description		Type	Part No.	Std. Pack	
Initiator block, gray		WK 2,5-4 KOI/U	57.503.7055.0	50	
<b>General data</b>					
Width / length / height, incl. TS 7.5		5 mm / 92 mm / 45 mm			
Wire strip length		10 mm			
Approvals					
<b>Technical data</b>		<b>IEC</b>	<b>UL</b>	<b>CSA</b>	
		EN 60 947-7-1			
Cross section fine-stranded		0.5–2.5 mm <sup>2</sup>			
Cross section solid/stranded		0.5–4 mm <sup>2</sup>			
Cross section, AWG		22–12			
Rated current, feed-through		16 A	20/30 A	25 A	
Rated voltage		400 V	300 V	300 V	
Rated impulse voltage		6 kV			
Pollution degree		3			
<b>Accessories</b>		Type	Part No.	Std. Pack	
Cross connector with screws,		2 pole	VB WK 2,5-2	Z7.280.0227.0	10
for signal feed through		3 pole	VB WK 2,5-3	Z7.280.0327.0	10
		up to 6 pole	VB WK 2,5-6	Z7.280.0627.0	10

### WK 2,5-4 KOI/U

- Initiator block with screw connection for mounting on TS 35 and TS 32
- Nominal cross section 2.5 mm<sup>2</sup>

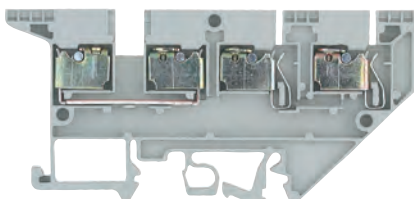

Description		Type	Part No.	Std. Pack
Initiator block, gray		WK 2,5-4 KOI/U-NGN	57.503.7155.0	50
Initiator block, gray		WK 2,5-4 KOI/U-PGN	57.503.7255.0	50
<b>General data</b>				
Width / length / height, incl. TS 7.5		5 mm / 92 mm / 45 mm		
Wire strip length		10 mm		
Approvals				
<b>Technical data</b>		<b>IEC</b>	<b>UL</b>	<b>CSA</b>
		EN 60 947-7-1		
Cross section fine-stranded		0.5–2.5 mm <sup>2</sup>		
Cross section solid/stranded		0.5–4 mm <sup>2</sup>		
Cross section, AWG		22–12		
Rated current, feed-through		16 A	20/30 A	25 A
Rated voltage		24 DC	24 V	24 V
Rated impulse voltage				
Pollution degree				

  

**NGN:** Indicator: R = 2.2 K 0,35W  
Lamp color: green

**PGN:** Indicator: R = 2.2 K 0,35W  
Lamp color: green

### WK 2,5-4 KOI/U-NGN WK 2,5-4 KOI/U-PGN

- Initiator block with screw connection for mounting on TS 35 and TS 32
- **NGN:** With LED (green) between signal and plus
- **PGN:** With LED (green) between signal and minus
- Nominal cross section 2.5 mm<sup>2</sup>

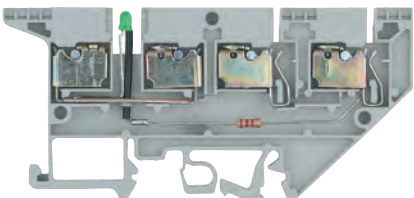

## Accessories for selos WK 2,5-4 KOI/U...

Accessories		Type	Part No.	Std. Pack	
End plate		gray	AP 2,5-4 KO	07.310.9355.0	50
Partition		gray	TW 2,5-4 KO	07.310.9455.0	50
Cross connector		2 pole	VB WK 2,5 KO-2	07.257.0227.0	100
for voltage supply		3 pole	VB WK 2,5 KO-3	07.257.0327.0	100
		up to 20 pole	VB WK 2,5 KO-20	07.257.2027.0	50
Partition plate with marking facility		yellow	TS 2,5 GELB	07.311.2053.8	10
Single cover with marking facility		yellow	AD VB 2,5 GELB	04.326.2053.8	10
Cover strip for cross connectors over 10 blocks			AD VB 5/10	04.342.0556.0	10
Tear-off marking strip, red, marked "+"		red	9705 A/5/10 B + ROT	04.855.0253.5	25
Tear-off marking strip, blue, marked "-"		blue	9705 A/5/10 B - BLAU	04.855.0353.6	25



## Fuse blocks with screw connection

### WK 4 TKG... with THSi 5x20

- Disconnect base block with screw connection for mounting on TS 35 and TS 32
- Nominal cross section 4 mm<sup>2</sup>

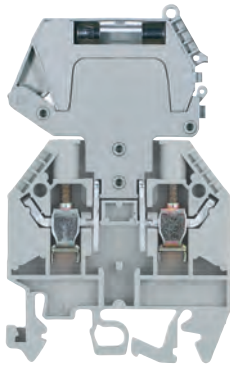

Description	Type	Part No.	Std. Pack
Disconnect base block, gray	WK 4 TKG/U	57.504.4055.0	100
Fuse disconnect lever, gray	THSi 5x20	Z1.298.1053.0	10
Fuse disconnect lever with LED 12 - 24V <sup>2)</sup>	THSi 5x20 LED24	Z1.298.1153.0	10
Fuse disconnect lever with LED 24 - 60V <sup>2)</sup>	THSi 5x20 LED60	Z1.298.1253.0	10
Fuse disconnect lever with GL 110 - 250V <sup>2)</sup>	THSi 5x20 GL250	Z1.298.1353.0	10

General data				
Width / length / height, incl. TS 7.5	6 mm / 48 mm / 81 mm			
Wire strip length	9 mm			
Approvals				
Technical data		IEC	UL	CSA
		EN 60947-7-1, EN 60127-6		
Cross section fine-stranded	0.5 - 4 mm <sup>2</sup>			
Cross section solid/stranded	0.5 - 6 mm <sup>2</sup>			
Cross section, AWG		22 - 10	20 - 10	
Rated current	1)	10 A <sup>1)</sup>	6.3 A <sup>1)</sup>	
Rated voltage		690 V <sup>2)</sup>	300 V <sup>2)</sup>	250 V <sup>2)</sup>
Rated impulse voltage		6 kV		
Pollution degree	3			

### WK 4 TKG... with THSi 6,3x32

- Disconnect base block with screw connection for mounting on TS 35 and TS 32
- Nominal cross section 4 mm<sup>2</sup>

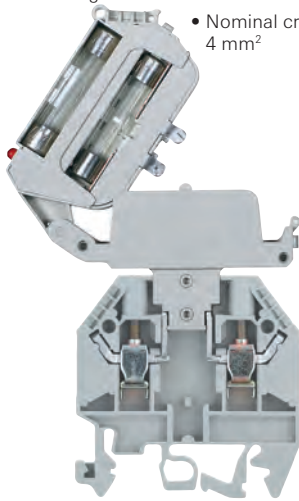

Description	Type	Part No.	Std. Pack
Disconnect base block, gray	WK 4 TKG/U	57.504.4055.0	100
Fuse disconnect lever, gray	THSi 6,3x32	Z1.298.1653.0	10
Fuse disconnect lever with LED 12 - 24V <sup>2)</sup>	THSi 6,3x32 LED24	Z1.298.1753.0	10
Fuse disconnect lever with LED 24 - 60V <sup>2)</sup>	THSi 6,3x32 LED60	Z1.298.1853.0	10
Fuse disconnect lever with GL 110 - 250V <sup>2)</sup>	THSi 6,3x32 GL250	Z1.298.1953.0	10

General data				
Width / length / height, incl. TS 7.5	6 mm / 48 mm / 81 mm			
Width disconnect lever THSi 6.3x32	8 mm	use end plate 07.311.6155.0 to maintain pitch		
Wire strip length	9 mm			
Approvals				
Technical data		IEC	UL	CSA
		EN 60947-7-1, EN 60127-6		
Cross section fine-stranded	0.5 - 4 mm <sup>2</sup>			
Cross section solid/stranded	0.5 - 6 mm <sup>2</sup>			
Cross section, AWG		22 - 10	20 - 10	
Rated current	1)	10 A <sup>1)</sup>	6.3 A <sup>1)</sup>	
Rated voltage		690 V <sup>2)</sup>	300 V <sup>2)</sup>	250 V <sup>2)</sup>
Rated impulse voltage		6 kV		
Pollution degree	3			

## Technical information:

<sup>1)</sup> When selecting G fuse inserts, make sure that the specified maximum power loss is not exceeded. The current is determined by the inserted fuse.

<sup>2)</sup> The voltage range is determined by the built-in LED display.

Maximum power loss at 23°C ambient temperature (according to DIN EN 60947-7-3)

Type	Rated Voltage	Overload protection		Exclusive short-circuit protection	
		Single arrangement	Group arrangement	Single arrangement	Group arrangement
THSi 5x20	250V	2.5W	1.6W	4.0W	2.5W
THSi 6,3x32	500V	2.5W	1.6W	4.0W	4.0W
SIST	250V	2.5W	1.6W	2.5W	2.5W

Depending on the application and the installation method, the possibility of increased temperature must be checked in the closed fuse holders.

Higher ambient temperatures mean additional stress for the fuse inserts. Therefore, the reduction of the rated current must be considered accordingly in these applications.

Indicator (24V): Lamp color: red  
Power consumption: 10.3mA

Indicator (220V): Lamp color: red  
Power consumption: 0.3mA

**WK 4 TKG... SIST**

- Disconnect base block with screw connection for mounting on TS 35 and TS 32
- Nominal cross section 4 mm<sup>2</sup>

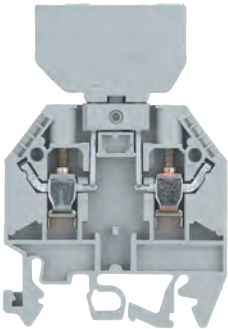

Description	Type	Part No.	Std. Pack
Disconnect base block, gray	WK 4 TKG/U	57.504.4055.0	100
Fuse holder for 5x20 fuse	Si ST	Z1.299.4055.0	10
Fuse holder with LED 24-60V	Si ST LED	Z1.299.4155.0	10
Fuse holder with GL 220V	Si ST GL	Z1.299.4255.0	10

General data				
Width / length / height, incl. TS 7.5	6 mm / 48 mm / 68 mm			
Wire strip length	9 mm			
Approvals				
Technical data		IEC	UL	CSA
		EN 60947-7-1, EN 60127-6		
Cross section fine-stranded	0.5–4 mm <sup>2</sup>			
Cross section solid/stranded	0.5–6 mm <sup>2</sup>			
Cross section, AWG	22–10			
Rated current	1) <sup>1)</sup>	10 A	6.3 A <sup>1)</sup>	
Rated voltage	690 V <sup>2)</sup>	300 V	250 V	
Rated impulse voltage	6 kV			
Pollution degree	3			

**WK 4 TKG... DIST**

- Disconnect base block with screw connection for mounting on TS 35 and TS 32
- Nominal cross section 4 mm<sup>2</sup>

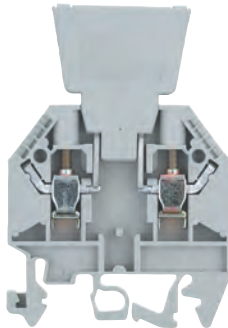

Description	Type	Part No.	Std. Pack
Disconnect base block, gray	WK 4 TKG/U	57.504.4055.0	100
Diode plug - without contacts	DIST ...	Z1.299.3055.0	10
Diode plug - diode $I_{max} = 1 A$	DIST-1 N 4007-1 <sup>3)</sup>	Z1.299.3155.0	10
Diode plug - diode $I_{max} = 1 A$	DIST-1 N 4007-2 <sup>4)</sup>	Z1.299.3355.0	10
Diode plug with jumper $I_{max} = 10 A$	DIST-D	Z1.299.3255.0	10

General data				
Width / length / height, incl. TS 7.5	6 mm / 48 mm / 68 mm			
Wire strip length	9 mm			
Approvals				
Technical data		IEC	UL	CSA
		EN 60947-7-1, EN 60127-6		
Cross section fine-stranded	0.5–4 mm <sup>2</sup>			
Cross section solid/stranded	0.5–6 mm <sup>2</sup>			
Cross section, AWG	22–10			
Rated current		10 A	6.3 A <sup>1)</sup>	
Rated voltage	690 V <sup>2)</sup>	300 V	250 V	
Rated impulse voltage	6 kV			
Pollution degree	3			

The current carrying load depends on the component used.  
 Temporary peak voltage 1000 V.  
 Pole assignment Anode Cathode<sup>3)</sup>  
 of the diode: Cathode Anode<sup>4)</sup>

## Accessories for **selos** WK 4 TKG... with THSi5..., SIST... and DIST...

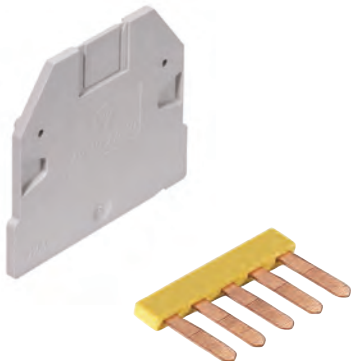

Accessories	Type	Part No.	Std. Pack
End plate	gray AP 4 TK	07.311.6155.0	10
Partition	gray TW 4 TK	07.311.8155.0	10
Jumper comb, insulated	2 pole	IVB 1 WK 4..-2	10
	3 pole	IVB 1 WK 4..-3	10
	up to 6 pole	IVB 1 WK 4..-6	10

## Fuse- and knife edge disconnect blocks with screw connection

### WK 4/Si-D/U 5x25

- Fuse block with screw connection for mounting on TS 35 and TS 32
- Nominal cross section 4 mm<sup>2</sup>

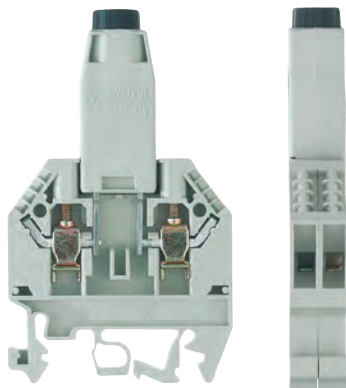

Description	Type	Part No.	Std. Pack
Fuse block, gray			
w. G-screw cap B DIN 41674, 5x25 mm	WK 4/Si-D/U 5 x 25	57.504.1655.0	50
w. G-SG-screw cap A DIN 41674, 5x20 mm	WK 4/Si-D/U 5 x 20	57.504.1755.0	50
<b>General data</b>			
Width / length / height, incl. TS 7.5	12 mm / 48 mm / 49 mm		
Wire strip length	9 mm		
Approvals			
<b>Technical data</b>	<b>IEC</b>	<b>UL</b>	<b>CSA</b>
	EN 60947-7-1, EN 60 127-6		
Cross section fine-stranded	0.5–4 mm <sup>2</sup>		
Cross section solid/stranded	0.5–6 mm <sup>2</sup>		
Cross section, AWG			20–10
Rated current	6.3 A		10 A
Rated voltage	690 V		250 V
Rated impulse voltage	6 kV		
Pollution degree	3		

### WK 4/TKM

- Knife edge disconnect block with screw connection for mounting on TS 35 and TS 32
- Nominal cross section 4 mm<sup>2</sup>
- \* **Version with test bolt:** CSA: 300V  
EN 60 947-7-1 – 400V/4kV/3  
Test bolt can be loaded with 1 A

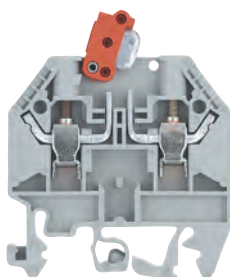

Description	Type	Part No.	Std. Pack
Knife edge disconnect block, gray	WK 4/TKM/U	57.504.2055.0	100
Knife edge disconnect block, blue	WK 4/TKM/U BLAU	57.504.2055.6	100
with 2 test bolts, gray	WK 4/TKM/P3/U	57.504.2355.0	100
<b>General data</b>			
Width / length / height, incl. TS 7.5	6 mm / 48 mm / 49 mm		
Wire strip length	9 mm		
Approvals			
<b>Technical data</b>	<b>IEC</b>	<b>UL</b>	<b>CSA</b>
	EN 60947-7-1, EN 60 127-6		
Cross section fine-stranded	0.5–4 mm <sup>2</sup>		
Cross section solid/stranded	0.5–6 mm <sup>2</sup>		
Cross section, AWG		22–10	22–10
Rated current	20 A	20 A	20 A
Rated voltage	690 V	600 V	600 V
Rated impulse voltage	6 kV		
Pollution degree	3		

**WK 4 TKG-TRST/U**

- Invertible plug disconnect block with screw connection for mounting on TS 35 and 42
- Nominal cross section 4 mm<sup>2</sup>
- \* **Version with test bolt:** CSA: 300V  
EN 60 947-7-1 – 400V/4kV/3  
Test bolt can be loaded with 1 A

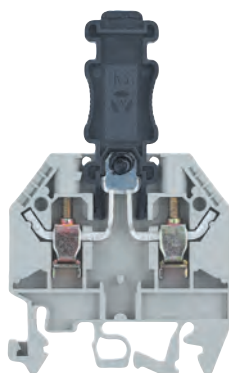

Description	Type	Part No.	Std. Pack
Invertible plug disconnect block, gray	WK 4 TKG-TRST/U	57.504.4555.0	100
with 2 test bolts, gray	WK 4 TKG-TRST P3/U	57.504.4855.0	100
<b>General data</b>			
Width / length / height, incl. TS 7.5	6 mm / 48 mm / 78 mm		
Wire strip length	9 mm		
Approvals			
<b>Technical data</b>	<b>IEC</b>	<b>UL</b>	<b>CSA</b>
	EN 60947-7-1, EN 60127-6		
Cross section fine-stranded	0.5–4 mm <sup>2</sup>		
Cross section solid/stranded	0.5–6 mm <sup>2</sup>		
Cross section, AWG		22–10	22–10
Rated current	20 A	10 A	20 A
Rated voltage	690 V	300 V	600 V
Rated impulse voltage	6 kV		
Pollution degree	3		

**WK 4 TKS D/U**

- Feed-through block with screw connection for mounting on TS 35 and TS 32
- Nominal cross section 4 mm<sup>2</sup>
- Same dimensions as types WK 4 TKG/U and types WK 4/TKM/U

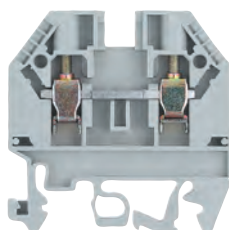

Description	Type	Part No.	Std. Pack
Feed-through block, gray	WK 4 TKS D/U	57.504.4455.0	100
<b>General data</b>			
Width / length / height, incl. TS 7.5	6 mm / 48 mm / 49 mm		
Wire strip length	9 mm		
Approvals			
<b>Technical data</b>	<b>IEC</b>	<b>UL</b>	<b>CSA</b>
	EN 60947-7-1, EN 60127-6		
Cross section fine-stranded	0.5–4 mm <sup>2</sup>		
Cross section solid/stranded	0.5–6 mm <sup>2</sup>		
Cross section, AWG		22–10	20–10
Rated current	32 A	25 A	20 A
Rated voltage	690 V	300 V	600 V
Rated impulse voltage	6 kV		
Pollution degree	3		

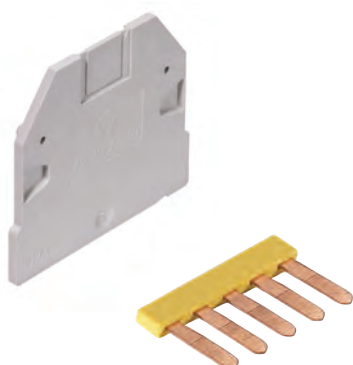
**Accessories for selos WK 4...**

Accessories	Type	Part No.	Std. Pack
End plate	gray AP 4 TK	07.311.6155.0	10
Partition	gray TW 4 TK	07.311.8155.0	10
Jumper comb, insulated	2 pole	IVB 1 WK 4..-2	Z7.255.4227.0
	3 pole	IVB 1 WK 4..-3	Z7.255.4327.0
	up to 6 pole	IVB 1 WK 4..-6	Z7.255.4627.0

## Fuse blocks with screw connection

### WK 4 THSi 5.../U

- Integrated lever-action fuse block with screw connection for mounting on TS 35 and TS 32
- Nominal cross section 4 mm<sup>2</sup>
- For 5 mm miniature fuses
- The standard block has a storage location for a replacement fuse.

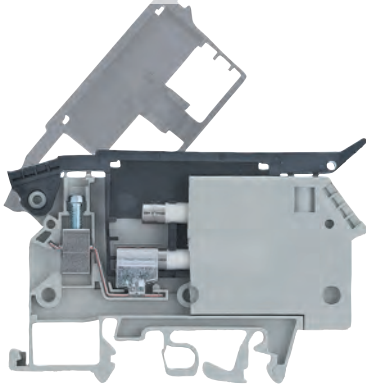

Description	Type	Part No.	Std. Pack
Fuse block, gray	WK 4/THSi 5 ... U	57.904.5355.0	50
- with LED 5-12V~/= current consumed. 2.3-7 mA	WK 4/THSi 5 LED 12 U	57.904.5455.0	50
- with LED 12-24V~/= current con. 2.8-6.2 mA	WK 4/THSi 5 LED 24 U	57.904.5555.0	50
- with LED 24-60V~/= current con. 1.5-4 mA	WK 4/THSi 5 LED 60 U	57.904.5655.0	50
- with GL110-250V~/= current con.0.13-0.55 mA	WK 4/THSi 5 GL 250 U	57.904.5755.0	50
- with GL380-500V~/= current con. 0.2-0.3 mA	WK 4/THSi 5 GL 500 U	57.904.5855.0	50

General data				
Width / length / height, incl. TS 7.5	8 mm / 77 mm / 54 mm			
Wire strip length	8 mm			
Approvals				
Technical data		IEC	UL	CSA
		EN 60947-7-1, EN 60127-6		
Cross section fine-stranded	0,5-4 mm <sup>2</sup>			
Cross section solid/stranded	0,5-6 mm <sup>2</sup>			
Cross section, AWG		22-10	22-10	
Rated current	6.3 A <sup>1)</sup>	15 A	6.3 A	
Rated voltage	800 V <sup>2)</sup>	600 V <sup>2)</sup>	600 V <sup>2)</sup>	
Rated impulse voltage	8 kV			
Pollution degree	3			

### WK 4 THSi 6,3.../U

- Integrated lever-action fuse block with screw connection for mounting on TS 35 and TS32
- Nominal cross section 4 mm<sup>2</sup>
- For 6.3mm miniature fuses
- The standard block has a storage location for a replacement fuse.

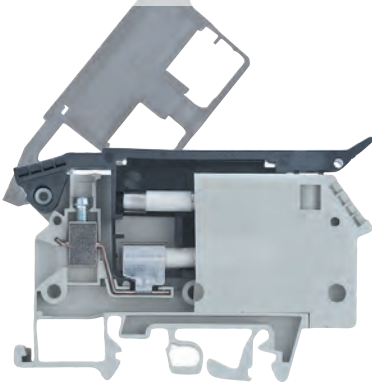

Description	Type	Part No.	Std. Pack
Fuse block, gray	WK 4/THSi 6,3 ... U	57.904.6355.0	50
- with LED 5-12V~/= current consumed. 2.3-7 mA	WK 4/THSi 6,3 LED 12 U	57.904.6455.0	50
- with LED 12-24V~/= current con. 2.8-6.2 mA	WK 4/THSi 6,3 LED 24 U	57.904.6555.0	50
- with LED 24-60V~/= current con. 1.5-4 mA	WK 4/THSi 6,3 LED 60 U	57.904.6655.0	50
- with GL110-250V~/= current con.0.13-0.55 mA	WK 4/THSi 6,3 GL 250 U	57.904.6755.0	50
- with GL380-500V~/= current con. 0.2-0.3 mA	WK 4/THSi 6,3 GL 500 U	57.904.6855.0	50

General data				
Width / length / height, incl. TS 7.5	10 mm / 77 mm / 54 mm			
Wire strip length	8 mm			
Approvals				
Technical data		IEC	UL	CSA
		EN 60947-7-1, EN 60127-6		
Cross section fine-stranded	0,5-4 mm <sup>2</sup>			
Cross section solid/stranded	0,5-6 mm <sup>2</sup>			
Cross section, AWG		22-10	22-10	
Rated current	10 A <sup>1)</sup>	15 A	10 A	
Rated voltage	800 V <sup>2)</sup>	600 V <sup>2)</sup>	600 V <sup>2)</sup>	
Rated impulse voltage	8 kV			
Pollution degree	3			

## Technical information for **selos** WK 4 THSi...

The fuse blocks of this type have a flip top disconnect lever. It accepts miniature fuses of 5x20, 5x25 and 5x30 mm (terminal width: 8mm) or 6.3x32 mm (terminal width: 10mm). The hinged lever has latch points both in the open and in the closed position, and can be sealed.

All terminal blocks are available in two different versions, i.e. with or without red LEDs functioning as indicators.

<sup>1)</sup> When selecting G fuse inserts, make sure that the specified maximum power loss is not exceeded. The current is determined by the inserted fuse.

<sup>2)</sup> The voltage range is determined by the built-in LED display.

Depending on the application and the installation method, the circumstances for increased temperature must be checked in the closed fuse holders. Higher ambient temperatures are an additional load for the fuse inserts. Therefore, the reduction of the rated current must be considered accordingly in these applications.

<sup>1)</sup> Maximum power loss at 23°C ambient temperature (according to DIN EN 60947-7-3)

Type	Rated voltage	Overload protection		Exclusive short-circuit protection	
		Single arrangement	Group arrangement	Single arrangement	Group arrangement
THSi 5x20/25	250V	1.6W	1.6W	4.0W	2.5W
THSi 6,3x32	500V	2.5W	2.5W	4.0W	2.5W
THSi 5x30	500V	1.6W	1.6W	4.0W	2.5W

## Accessories and info for **selos** WK 10/Si...

Accessories	Type	Part No.	Std. Pack
End plate, gray	AP 10/Si	07.311.4155.0	10
Cross connector with screws	2 pole	VB WK 10/Si-2	Z7.287.0227.0
	3 pole	VB WK 10/Si-3	Z7.287.0327.0
	up to 6 pole	VB WK 10/Si-6	Z7.287.0627.0
Transparent block cover (for 1 block)		04.312.2056.0	100

<sup>1)</sup> Maximum power loss at 23°C ambient temperature (according to DIN EN 60947-7-3)

Type	Overload protection		Exclusive short-circuit protection	
	Single arrangement	Group arrangement	Single arrangement	Group arrangement
WK 10 Si U 5x20	4.0W/10A	2.5W/6.3A	4.0W/10A	4.0W/6.3A
WK 10 Si U 6,3x32	4.0W/10A	2.5W/2.5A	4.0W/10A	2.5W/2.5A
WK 10 Si U 5x25	4.0W/10A	2.5W/6.3A	4.0W/10A	4.0W/6.3A
WK 10 Si U 5x30	4.0W/10A	2.5W/6.3A	4.0W/10A	4.0W/6.3A



### WK 10/SI .../U

- Fuse block with screw cap for mounting on TS 35
- Nominal cross section 10 mm<sup>2</sup>
- \* Voltage and current are determined by the built-in LED and the inserted G-fuse.

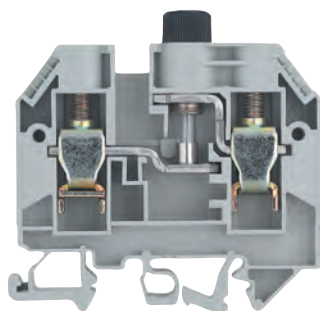

Description	Type	Part No.	Std. Pack
Fuse block, gray, with screw cap			
– A DIN 41674 for G-fuses DIN 41571	WK 10/Si U 5 x 20	57.910.5055.0	50
– B DIN 41674 for G-fuses DIN 41576	WK 10/Si U 5 x 25	57.910.5155.0	50
– A DIN 41674 for G-fuses	WK 10/Si U 5 x 30	57.910.5255.0	50
– with screw cap for G-fuses	WK 10/Si U 6,3 x 32	57.910.5355.0	50
<b>General data</b>			
Width / length / height, incl. TS 7.5	12 mm / 65 mm / 58 mm		
Wire strip length	13 mm		
Approvals			
<b>Technical data</b>	<b>IEC</b>	<b>UL</b>	<b>CSA</b>
	EN 60947-7-1, EN 60 127-6		
Cross section fine-stranded	1.0–10 mm <sup>2</sup>		
Cross section solid/stranded	1.0–16 mm <sup>2</sup>		
Cross section, AWG		22–6	16–6
Rated current	max. 10 A <sup>1)</sup>	15 A	max. 15 A
Rated voltage	500 V*	600 V*	600 V*
	* 57.910.5055.0 250 V~	600 V	600 V
	* 57.910.5155.0 250 V~	600 V	600 V
	* 57.910.5255.0 500 V~	600 V	600 V
	* 57.910.5355.0 500 V~	600 V	600 V
Rated impulse voltage	6 kV		
Pollution degree	3		

### WK 10/SI .../U with indicator

- Fuse block with screw cap for mounting on TS 35 and TS 32
- Nominal cross section 10 mm<sup>2</sup>
- With indicator
- \* Voltage and current are determined by the built-in indicator and the inserted G-fuse.

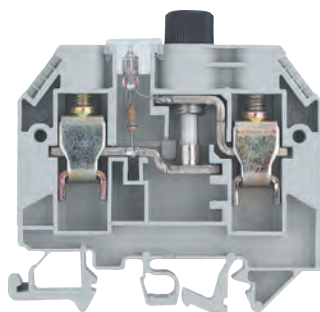

Description	Type	Part No.	Std. Pack
Fuse block, gray, with screw cap			
– A DIN 41674 for G-fuses DIN 41571	WK 10/Si U 5 x 20M, NGL	57.910.5455.0	50
– B DIN 41674 for G-fuses DIN 41576	WK 10/Si U 5 x 20M, GLB	57.910.5855.0	50
– A DIN 41674 for G-fuses	WK 10/Si U 6,3 x 32M, NGL	57.910.5755.0	50
– with screw cap for G-fuses	WK 10/Si U 6,3 x 32M, GLB	57.910.6155.0	50
<b>General data</b>			
Width / length / height, incl. TS 7.5	12 mm / 65 mm / 58 mm		
Wire strip length	13 mm		
Approvals			
<b>Technical data</b>	<b>IEC</b>	<b>UL</b>	<b>CSA</b>
	EN 60947-7-1, EN 60 127-6		
Cross section fine-stranded	1.0–10 mm <sup>2</sup>		
Cross section solid/stranded	1.0–16 mm <sup>2</sup>		
Cross section, AWG		22–6	16–6
Rated current	max. 10 A <sup>1)</sup>	15 A	max. 15 A
Rated voltage	500 V*	600 V*	600 V*
Indicator – Current consumed			
red – 0.16–0.8 mA * 57.910.5455.0	110 - 250 V~	150 V	500 V
yellow – 24 mA * 57.910.5855.0	28 V~	28 V	28 V
red – 0.16–0.8 mA * 57.910.5755.0	110 - 500 V~	150 V	500 V
yellow – 24 mA * 57.910.6155.0	28 V~	28 V	28 V
Rated impulse voltage	6 kV		
Pollution degree	3		

### WK 10/SI U D

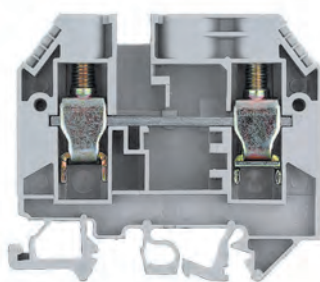

- Feed-through block with screw connection for mounting on TS 35
- Nominal cross section 10 mm<sup>2</sup>
- Same dimensions as fuse block





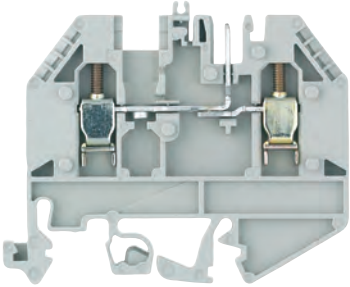

Description	Type	Part No.	Std. Pack
Feed-through block, gray	WK 10/Si U D	57.910.4955.0	50
<b>General data</b>			
Width / length / height, incl. TS 7.5	12 mm / 65 mm / 58 mm		
Wire strip length	13 mm		
Approvals			
<b>Technical data</b>	<b>IEC</b>	<b>UL</b>	<b>CSA</b>
	EN 60947-7-1		
Cross section fine-stranded	0.5–4 mm <sup>2</sup>		
Cross section solid/stranded	0.5–6 mm <sup>2</sup>		
Cross section, AWG		22–6	16–6
Rated current	57 A	50 A	65 A
Rated voltage	500 V	600 V	600 V
Rated impulse voltage	6 kV		
Pollution degree	3		

# Feed-through blocks with *wiecon* pluggable connection

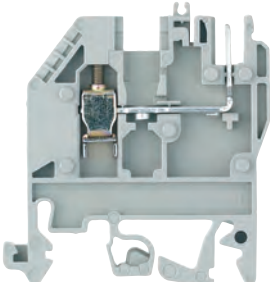
for PC board terminal type 8113 B, type 8313 B, type 8113 B/VL, type 8113 B/VR, type 8113 B/Top

WK 2,5 U/D/8113 S/V		Description	Type	Part No.	Std. Pack
<ul style="list-style-type: none"> <li>• Feed-through block with screw connection for mounting on TS 35 and TS 32</li> <li>• Nominal cross section 2,5 mm<sup>2</sup></li> </ul> 		Feed-through block, gray	WK 2,5 U/D/8113 S/V...	57.503.2155.0	50
		Power block, blue	WK 2,5 U/D/8113 S/V/VK	57.503.2555.6	50
		Feed-through block, with LED 25V, gray	WK 2,5 U/D/8113 S/V/LED 25	57.503.2255.0	50
		Feed-through block, with LED 50V, gray	WK 2,5 U/D/8113 S/V/LED 50	57.503.2355.0	50
<b>General data</b>					
	Width / length / height, incl. TS 7.5	5 mm / 61 mm / 51 mm			
	Wire strip length	9 mm			
	Approvals				
	<b>Technical data</b>	<b>IEC</b>	<b>UL</b>	<b>CSA</b>	
		EN 60947-7-1			
	Cross section fine-stranded	0.5–2,5 mm <sup>2</sup>			
	Cross section solid/stranded	0.5–4 mm <sup>2</sup>			
	Cross section, AWG		22–12	24–12	
	Rated current	12 A	15 A	15 A	
	Rated voltage	250 V	300 V	300 V	
	Rated impulse voltage	4 kV			
	Pollution degree	3			
<b>Accessories</b>					
	End plate, gray	Type	Part No.	Std. Pack	
		AP 2,5 U/D/8113 S/V	07.311.9055.0	10	
	Spacer* 2.5 mm thick	ZP 2,5 U/D/8113 S/V	07.311.9155.0	10	
	Cover strip for LED, transparent 10 pole	AD VB 5/10 P	04.342.3556.8	10	
	Coding strip		05.561.0053.0	100	
* for <i>wiecon</i> PC board connector with 7.5 mm pitch					

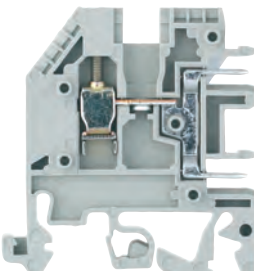
WK 2,5 U/8113 S/V		Description	Type	Part No.	Std. Pack
<ul style="list-style-type: none"> <li>• Feed-through block with screw connection for mounting on TS 35 and TS 32</li> <li>• Nominal cross section 2,5 mm<sup>2</sup></li> </ul> 		Feed-through block, gray	WK 2,5 U/8113 S/V...	57.503.2655.0	50
		Power block, blue	WK 2,5 U/8113 S/V/VK	57.503.3055.6	50
		Feed-through block, with LED 25V, gray	WK 2,5 U/8113 S/V/LED 25	57.503.2755.0	50
		Feed-through block, with LED 50V, gray	WK 2,5 U/8113 S/V/LED 50	57.503.2855.0	50
<b>General data</b>					
	Width / length / height, incl. TS 7.5	5 mm / 44 mm / 51 mm			
	Wire strip length	9 mm			
	Approvals				
	<b>Technical data</b>	<b>IEC</b>	<b>UL</b>	<b>CSA</b>	
		EN 60947-7-1			
	Cross section fine-stranded	0.5–2,5 mm <sup>2</sup>			
	Cross section solid/stranded	0.5–4 mm <sup>2</sup>			
	Cross section, AWG		22–12	24–12	
	Rated current	12 A	15 A	15 A	
	Rated voltage	250 V	300 V	300 V	
	Rated impulse voltage	4 kV			
	Pollution degree	3			
<b>Accessories</b>					
	End plate, gray	Type	Part No.	Std. Pack	
		AP 2,5 U/8113 S/V	07.312.1555.0	10	
	Spacer* 2.5 mm thick	ZP 2,5 U/8113 S/V	07.312.1655.0	10	
	Coding strip		05.561.0053.0	100	
* for <i>wiecon</i> PC board connector with 7.5 mm pitch					

WK 2,5 U/D/8113 S/H		Description	Type	Part No.	Std. Pack	
<ul style="list-style-type: none"> <li>• Feed-through block with screw connection for mounting on TS 35 and TS 32</li> <li>• Nominal cross section 2,5 mm<sup>2</sup></li> </ul> 		Feed-through block, gray	WK 2,5 U/8113 S/H	57.503.2055.0	100	
	<b>General data</b>					
		Width / length / height, incl. TS 7.5	5 mm / 44 mm / 48 mm			
		Wire strip length	9 mm			
	Approvals					
	<b>Technical data</b>	<b>IEC</b>	<b>UL</b>	<b>CSA</b>		
		EN 60947-7-1				
	Cross section fine-stranded	0.5–2,5 mm <sup>2</sup>				
	Cross section solid/stranded	0.5–4 mm <sup>2</sup>				
	Cross section, AWG		22–12	24–12		
	Rated current	12 A	20 A	15 A		
	Rated voltage	250 V	300 V	300 V		
	Rated impulse voltage	4 kV				
	Pollution degree	3				
<b>Accessories</b>						
	End plate, gray	Type	Part No.	Std. Pack		
		AP 2,5 U/8113 S/H	07.311.9855.0	10		
	Coding strip		05.584.0053.0	100		
	Locking piece 10 pole		05.576.5853.0	25		

### Type 8113 B/..., 8313 B/...

- Mating orientation parallel to wire entry
- For additional pluggable blocks, see **wiecon** product family



Description	Type	Part No.	Std. Pack
<b>Spacing 5.00 mm, Rated voltage 250 V</b>			
unmarked, starting at 2	8113 B/2 OB	25.320.3253.0	100
up to 16	8113 B/16 OB	25.320.4653.0	50
marked with 1- x, starting at 2	8113 B/2	25.320.0253.0	100
up to 16	8113 B/16	25.320.1653.0	50
<b>Spacing 7.50 mm, Rated voltage 400 V</b>			
unmarked, starting at 2	8313 B/2 OB	25.360.3253.0	100
up to 12	8313 B/12 OB	25.360.4253.0	50
marked with 1- x, starting at 2	8313 B/2	25.360.0253.0	100
up to 12	8313 B/12	25.360.1253.0	50
<b>General data</b>			
Approvals			
<b>Technical data</b>	<b>IEC</b>	<b>UL</b>	<b>CSA</b>
	EN 60947-7-1		
Cross section fine-stranded	0.5–2.5 mm <sup>2</sup>		
Cross section solid/stranded	0.5–4 mm <sup>2</sup>		
Cross section, AWG		22–12	24–12
Rated current	12 A	15 A	15 A
Rated voltage	250 V	300 V	300 V
Rated impulse voltage	400 V		
Pollution degree			
<b>Accessories</b>			
Coding strip	Type	Part No.	Std. Pack
		05.561.9153.0	100

### Type 8113 B/... VR

- Mating orientation 90° towards the wire
- For additional pluggable blocks, see **wiecon** product family



Description	Type	Part No.	Std. Pack
<b>Spacing 5.00 mm, Rated voltage 250 V</b>			
unmarked, starting at 2	8113 B/2 VR OB	25.325.3253.0	100
up to 16	8113 B/16 VR OB	25.325.4653.0	50
marked with 1- x, starting at 2	8113 B/2	25.325.0253.0	100
up to 16	8113 B/16	25.325.1653.0	50
<b>General data</b>			
Approvals			
<b>Technical data</b>	<b>IEC</b>	<b>UL</b>	<b>CSA</b>
	EN 60947-7-1		
Cross section fine-stranded	0.5–2.5 mm <sup>2</sup>		
Cross section solid/stranded	0.5–4 mm <sup>2</sup>		
Cross section, AWG		22–12	24–12
Rated current	12 A	15 A	15 A
Rated voltage	250 V	300 V	300 V
Rated impulse voltage	400 V		
Pollution degree			
<b>Accessories</b>			
Coding strip	Type	Part No.	Std. Pack
		05.561.9153.0	100

## Accessories for **selos** WK 2,5 U/...



Accessories	Type	Part No.	Std. Pack	
Cross connector with screws, insulated	2 pole 3 pole	VB WK 2,5-2 IVB WK 2,5-3	Z7.280.2227.0 Z7.280.2327.0	10 10
Partition plate with marking facility	12 pole	IVB WK 2,5-12	Z7.280.3227.0	10
Single cover with marking facility	yellow	TS 2,5 GELB	07.311.2053.8	10
Cover strip for PCB terminal	yellow	AD VB 2,5 GELB	04.326.2053.8	10
with warning symbol	24 pole		04.343.9056.8	10
Connection rail	24 pole		04.343.9156.8	10
for connection to power block (blue) and indicator	L = 0,4 m		05.561.4115.0	1

## Distribution blocks with screw/push-on connection

### WK/4-8 S/IW/U

- Feed-through block with push-on connection for mounting on TS 35
- Push-on connectors 2.8 x 0.8 acc. to DIN 46247  
Push-on connectors 6.3 x 0.8 acc. to DIN 46247
- Current carrying capability according to DIN 46249  
Tab connector      2.8      10A  
                             6.3      20A

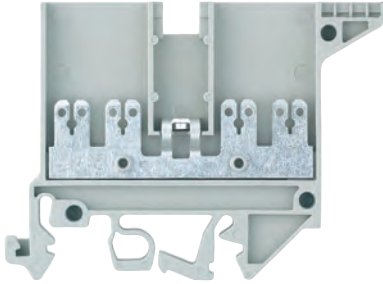

Description	Type	Part No.	Std. Pack
Feed-through block, gray	WK/4-8 S/IW/U	57.504.6355.0	100
<b>General data</b>			
Width / length / height, incl. TS 7.5	6 mm / 67 mm / 50 mm		
Wire strip length			
Approvals			
<b>Technical data</b>	<b>IEC</b>	<b>UL</b>	<b>CSA</b>
	EN 60947-7-1, EN 61210		
Cross section fine-stranded			
Cross section solid/stranded			
Cross section, AWG	22-12		
Rated current	20 A	10 A	10 A
Rated voltage	800 V <sup>(1)</sup>	600 V <sup>(1)</sup>	300 V <sup>(1)</sup>
Rated impulse voltage	8 kV		
Pollution degree	3		
<b>Accessories</b>			
End plate, gray	AP 3 S/IW	07.311.4355.0	50
Cross connector with screws	2 pole	VB WK/...S/IW/U-2	Z7.281.3227.0
	3 pole	VB WK/...S/IW/U-3	Z7.281.3327.0
	up to 6 pole	VB WK/...S/IW/U-6	Z7.281.3627.0

### WK/4-8 S/U

- Feed-through block with push-on connection for mounting on TS 35
- Push-on connectors 2.8 x 0.8 acc. to DIN 46247  
Push-on connectors 6.3 x 0.8 acc. to DIN 46247
- Current carrying capability according to DIN 46249  
Tab connector      2.8      10A  
                             6.3      20A

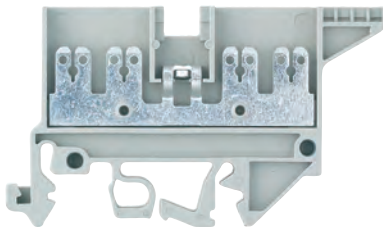

Description	Type	Part No.	Std. Pack
Feed-through block, gray	WK/4-8 S/U	57.504.6255.0	100
<b>General data</b>			
Width / length / height, incl. TS 7.5	6 mm / 67 mm / 40 mm		
Wire strip length			
Approvals			
<b>Technical data</b>	<b>IEC</b>	<b>UL</b>	<b>CSA</b>
	EN 60947-7-1, EN 61210		
Cross section fine-stranded			
Cross section solid/stranded			
Cross section, AWG	22-12		
Rated current	20 A	10 A	10 A
Rated voltage	800 V <sup>(1)</sup>	300 V <sup>(1)</sup>	300 V <sup>(1)</sup>
Rated impulse voltage	8 kV		
Pollution degree	3		
<b>Accessories</b>			
End plate, gray	AP 4 S	07.311.4255.0	10
Cross connector with screws	2 pole	9703/6-2	Z7.211.0227.0
	3 pole	9703/6-3	Z7.211.0327.0
	up to 6 pole	9703/6-6	Z7.211.0627.0

### WK/3-6 S KO/U

- Feed-through block with push-on connection for mounting on TS 35
- Nominal cross section 4,0 mm<sup>2</sup>
- Push-on connectors 2.8 x 0.8 acc. to DIN 46247  
Push-on connectors 6.3 x 0.8 acc. to DIN 46247
- Current carrying capability according to DIN 46249  
Tab connector      2.8      10A  
                             6.3      20A

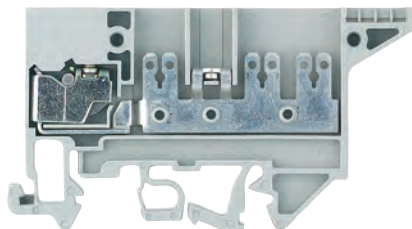

Description	Type	Part No.	Std. Pack
Feed-through block, gray	WK/3-6 S KO/U	57.504.7355.0	100
<b>General data</b>			
Width / length / height, incl. TS 7.5	6 mm / 72 mm / 40 mm		
Wire strip length	9 mm		
Approvals			
<b>Technical data</b>	<b>IEC</b>	<b>UL</b>	<b>CSA</b>
For use with insulating sleeves	EN 60947-7-1, EN 61210		
Cross section fine-stranded	0.5-4 mm <sup>2</sup>		
Cross section solid/stranded	0.5-4 mm <sup>2</sup>		
Cross section, AWG	22-12		
Rated current	20 A	10 A	10 A
Rated voltage	690 V <sup>(1)</sup>	300 V <sup>(1)</sup>	300 V <sup>(1)</sup>
Rated impulse voltage	8 kV		
Pollution degree	3		
<b>Accessories</b>			
End plate, gray	9701 A/6 1 S KO TP 2	07.310.5855.0	10
Cross connector with screws	2 pole	2072/2	Z7.220.0227.0
	3 pole	2072/2	Z7.220.0227.0
	up to 6 pole	2072/6	Z7.220.0627.0

### WK 4 3-6 S 1 K/U

- Feed-through block with push-on connection for mounting on TS 35
- Nominal cross section 4 mm<sup>2</sup>
- Push-on connectors 2.8 x 0.8 acc. to DIN 46247
- Push-on connectors 6.3 x 0.8 acc. to DIN 46247
- Current carrying capability according to DIN 46249
 

Tab connector	2.8	10A
	6.3	20A

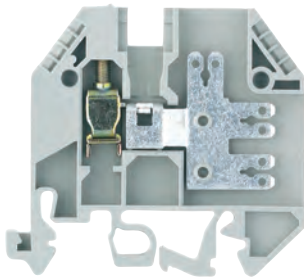

Description	Type	Part No.	Std. Pack
Feed-through block, gray	WK 4 3-6 S 1 K/U	57.504.3755.0	100
<b>General data</b>			
Width / length / height, incl. TS 7.5	6 mm / 52 mm / 48 mm		
Wire strip length	9 mm		
Approvals			
<b>Technical data</b>			
	<b>IEC</b>	<b>UL</b>	<b>CSA</b>
	EN 60947-7-1, EN 61 210		
Cross section fine-stranded	0.5–4 mm <sup>2</sup>		
Cross section solid/stranded	0.5–6 mm <sup>2</sup>		
Cross section, AWG		22–12	22–12
Rated current	20 A	10 A	10 A
Rated voltage	800 V <sup>1)</sup>	300 V <sup>1)</sup>	300 V <sup>1)</sup>
Rated impulse voltage	8 kV		
Pollution degree	3		
<b>Accessories</b>			
	Type	Part No.	Std. Pack
End plate, gray	AP4 3 S 1 K	07.311.3855.0	10
Cross connector with screws	2 pole	IVB WK 4-2	Z7.281.1227.0
	3 pole	IVB WK 4-3	Z7.281.1327.0
	up to 12 pole	IVB WK 4-12	Z7.281.2227.0

### WK/5-10 S/U

- Feed-through block with push-on connection for mounting on TS 35
- Push-on connectors 2.8 x 0.8 acc. to DIN 46247
- Push-on connectors 6.3 x 0.8 acc. to DIN 46247
- Current carrying capability according to DIN 46249
 

Tab connector	2.8	10A
	6.3	20A

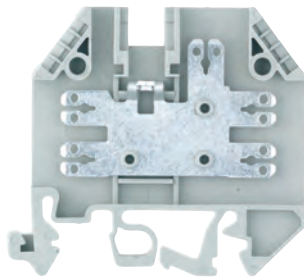

Description	Type	Part No.	Std. Pack
Feed-through block, gray	WK/5-10 S/U	57.504.3655.0	100
<b>General data</b>			
Width / length / height, incl. TS 7.5	6 mm / 52 mm / 48 mm		
Wire strip length	9 mm		
Approvals			
<b>Technical data</b>			
	<b>IEC</b>	<b>UL</b>	<b>CSA</b>
	EN 60947-7-1, EN 61 210		
Cross section fine-stranded	0.5–4 mm <sup>2</sup>		
Cross section solid/stranded	0.5–6 mm <sup>2</sup>		
Cross section, AWG		22–12	22–12
Rated current	20 A	10 A	10 A
Rated voltage	800 V <sup>1)</sup>	300 V <sup>1)</sup>	300 V <sup>1)</sup>
Rated impulse voltage	8 kV		
Pollution degree	3		
<b>Accessories</b>			
	Type	Part No.	Std. Pack
End plate, gray	AP 5 S	07.311.4655.0	10
Cross connector with screws	2 pole	IVB WKI 4-2	Z7.271.4227.0
	3 pole	IVB WKI 4-3	Z7.271.4327.0
	up to 12 pole	IVB WKI 4-12	Z7.271.5227.0

## Accessories for selos WK/...

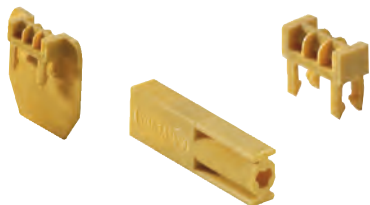

Accessories	Type	Part No.	Std. Pack
Partition plate with marking facility	yellow TS 4 GELB	07.311.2153.8	10
Single cover with marking facility	yellow AD VB 4 GELB	04.326.2153.8	10
Insulating sleeve for tab connector			
for H0. V-K 1.5 mm <sup>2</sup>	yellow	05.592.7553.0	2000
for H0. V-K 2.5 mm <sup>2</sup>	yellow	05.592.7653.0	2000

<sup>1)</sup> Rating for use with insulating sleeves

## Function blocks with screw connection

### 9786 U/12

- Function block with screw connection for mounting on TS 35 and TS 32
- Nominal cross section 2.5 mm<sup>2</sup>

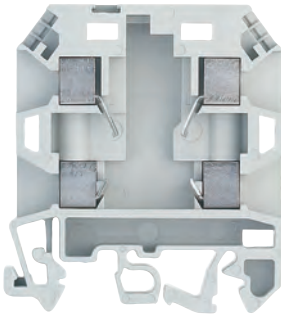

Description	Type	Part No.	Std. Pack
Function block empty	9786 U/12	57.904.2055.0	50
with bridge rectifier B380 C1500	9786 U/12 G4	57.904.2555.0	50
with optocoupler CNY 17/3	9786 U/12 OPK	57.904.2855.0	50

General data				
Width / length / height, incl. TS 7.5	12 mm / 52 mm / 58 mm			
Wire strip length	9 mm			
Approvals				
Technical data		IEC	UL	CSA
		EN 60947-7-1		
Cross section fine-stranded	0.5–2.5 mm <sup>2</sup>			
Cross section solid/stranded	0.5–2.5 mm <sup>2</sup>			
Cross section, AWG		22–14	22–14	
Rated current	24 A	6 A	6 A	
Rated voltage	800 V	300 V	300 V	
Rated impulse voltage	8 kV			
Pollution degree	3			

### 9785 U/... - SPT

- Compensating terminal with screw connection for mounting on TS 35 and TS 32
- Nominal cross section 2.5 mm<sup>2</sup>

Resistor range: 0.25Ω up to 100Ω  
 Resistor tolerance: ± 10%  
 Resistor range: 100Ω up to 50kΩ  
 Resistor tolerance: ± 20%  
 Limite continuous resistance value:  
 0.75W up to 70°C  
 Max. load: 100mA  
 Temperature coefficient: 0 up to +500 ppm/°C  
 Max. operating voltage: 300V

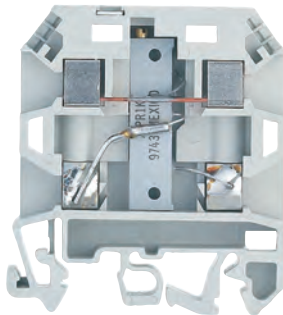

Description	Type	Part No.	Std. Pack
Compensating terminal, gray	10 Ω 9785 U/10 Ω	57.904.0055.0	50
with potentiometer	20 Ω 9785 U/20 Ω	57.904.0155.0	50
	50 Ω 9785 U/50 Ω	57.904.0255.0	50
	100 Ω 9785 U/100 Ω	57.904.0355.0	50
	200 Ω 9785 U/200 Ω	57.904.0455.0	50
	510 Ω 9785 U/500 Ω	57.904.0555.0	50
	1 kΩ 9785 U/1 kΩ	57.904.0655.0	50
	2 kΩ 9785 U/2 kΩ	57.904.0755.0	50
	5 kΩ 9785 U/5 kΩ	57.904.0855.0	50
	10 kΩ 9785 U/10 kΩ	57.904.0955.0	50
	20 kΩ 9785 U/20 kΩ	57.904.1055.0	50
50 kΩ 9785 U/50 kΩ	57.904.1155.0	50	
Compensating terminal, gray with potentiometer as voltage divider	10 Ω 9785 U/10 Ω-SPT	57.904.3955.0	50
	20 Ω 9785 U/20 Ω-SPT	57.904.4155.0	50
	50 Ω 9785 U/50 Ω-SPT	57.904.4255.0	50
	100 Ω 9785 U/100 Ω-SPT	57.904.4355.0	50
	200 Ω 9785 U/200 Ω-SPT	57.904.4455.0	50
	510 Ω 9785 U/500 Ω-SPT	57.904.4555.0	50
	1 kΩ 9785 U/1 kΩ-SPT	57.904.4655.0	50
	2 kΩ 9785 U/2 kΩ-SPT	57.904.4755.0	50
	5 kΩ 9785 U/5 kΩ-SPT	57.904.4855.0	50
	10 kΩ 9785 U/10 kΩ-SPT	57.904.4955.0	50
20 kΩ 9785 U/20 kΩ-SPT	57.904.5055.0	50	
50 kΩ 9785 U/50 kΩ-SPT	57.904.5155.0	50	

General/Technical data	
Width / length / height, incl. TS 7.5	12 mm / 49 mm / 58 mm
Wire strip length	9 mm
Approvals	EN 60947-7-1
Cross section fine-stranded	0.5–2.5 mm <sup>2</sup>
Cross section solid/stranded	0.5–2.5 mm <sup>2</sup>

### 9786 U/TSK...

- Thermocouple terminal with screw connection for mounting on TS 35 and TS 32
- Nominal cross section 2,5 mm<sup>2</sup>

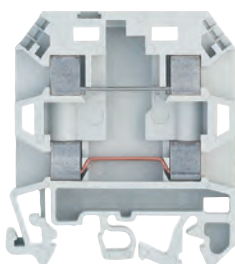

Description	Type	Part No.	Std. Pack
Thermocouple terminal type T-Cu/CuNi 44	9786 U/TSK Cu-CuNi	57.904.7355.0	50
Thermocouple terminal type E-NiCr/CuNi 44	9786 U/TSK NiCr-CuNi	57.904.7055.0	50
Thermocouple terminal type J-Fe/CuNi 44	9786 U/TSK Fe-CuNi	57.904.7155.0	50
Thermocouple terminal type K-NiCr/Ni	9786 U/TSK NiCr-Ni	57.904.7255.0	50
Thermocouple terminal type R-PtRh 13/Pt	9786 U/TSK E-Cu-A-Cu	57.904.7455.0	50

General data				
Width / length / height, incl. TS 7.5	12 mm / 52 mm / 58 mm			
Wire strip length	9 mm			
Approvals				
Technical data		IEC	UL	CSA
		EN 60947-7-1		
Cross section fine-stranded	0.5–2.5 mm <sup>2</sup>			
Cross section solid/stranded	0.5–2.5 mm <sup>2</sup>			
Rated voltage	800 V			
Rated impulse voltage	8 kV			
Pollution degree	3			

Example:  
 Fe/constantan Fe/CuNi 44  
 fully enclosed design

### 9786 U/12

- Ground disconnect with screw connection for mounting on TS 35 and TS 32
- Nominal cross section 6 mm<sup>2</sup>



Description	Type	Part No.	Std. Pack
Ground disconnect 24-48V $\equiv$ with LED	9760 U/8 TKE 48	57.110.1655.0	25
110-220V $\equiv$ with indicator lamp	9760 U/8 TKE 220	57.110.1555.0	25
<b>General data</b>			
Width / length / height, incl. TS 7.5	17,5 mm / 71 mm / 52 mm		
Wire strip length	9 mm		
Approvals			
<b>Technical data</b>	<b>IEC</b>	<b>UL</b>	<b>CSA</b>
	EN 60947-7-1		
Cross section fine-stranded	1.0–10 mm <sup>2</sup>		
Cross section solid/stranded	1.0–10 mm <sup>2</sup>		
Cross section, AWG		18–8	18–8
Rated current	30 A	25 A	25 A
Rated voltage	24–48 V / 110–220 V	48 V / 220 V	48 V / 220 V
Rated impulse voltage			
Pollution degree			

### EN 60204 part 1/DIN VDE 0113 part 1 "Fitting industrial machines with electrical equipment"

#### 9.4.3.1. Ground faults.

Ground faults in any control circuits must not result in unintentional startup, potentially hazardous motions or shutdown of the machine.

During normal operation the auxiliary circuit is connected to the functional ground and the green (24-48V) or yellow (110-220V) status display is illuminated.

If a low resistance ground fault occurs, the line fuse will blow.

Once the contact separator is open, you can replace the fuse.

The illumination of the red lamp alone indicates a ground fault.

After the fault had been rectified, the green (24-48V) or yellow (110-220V) display will also light up. The contacts should now be moved to the "on" position as a result of which the red lamp will go out.

The illumination of the yellow or green lamp and external display indicates that the auxiliary circuit has been reconnected to the functional ground.

#### Ground Disconnect terminal with LED 24-48V $\equiv$

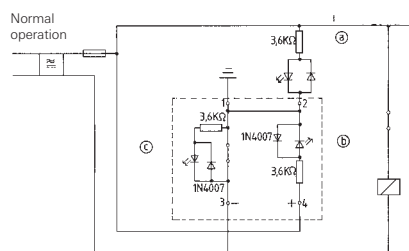

- (a) external status display lights up
- (b) green status display lights up
- (c) red ground-fault indicator lights up

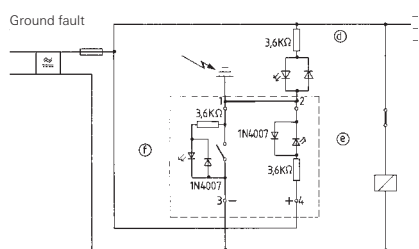

- (d) external status display lights up
- (e) green status display lights up
- (f) red ground-fault indicator lights up

#### Ground Disconnect terminal with Neon Lamp 110-220 V $\equiv$

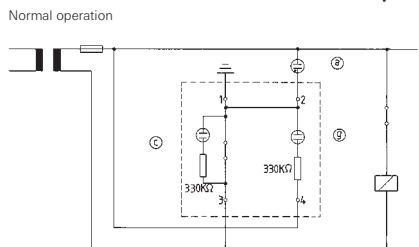

- (g) yellow status display lights up

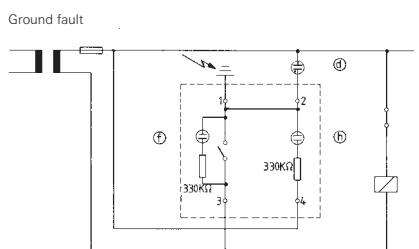

- (h) yellow indicator light not flashing

# Instrument isolating terminal with screw connection

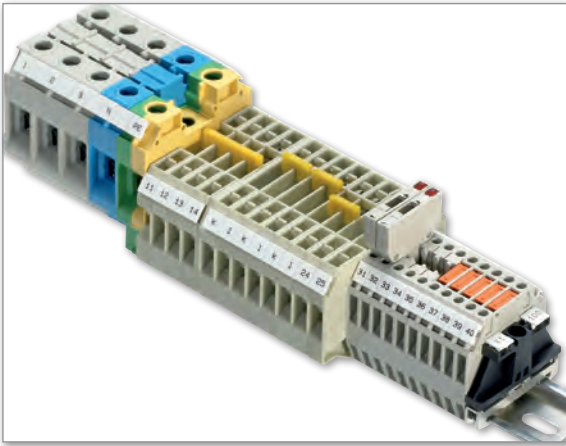

Wieland Electric's **selos** WKN 6 TK block offers a simple and effective DIN rail block solution for use in measuring circuits for current, voltage or energy. All circuits in everyday practice can be neatly implemented with the instrument isolating terminal and a few accessory parts. Only two blocks are needed for simple transformer circuits.

The main focus during the development of this block was clear and simple handling as well as universal application. All switching states of the block and the converter circuit are clearly recognizable and the extensive accessory program is easy to use.

The block and the accessories meet the requirements of protection against accidental finger touch as per BGV A2.

**Technical data as per EN 60947-7:**

Rated cross section:	6mm <sup>2</sup>	Rated current:	57A
Rated voltage:	400V	Connection capacity:	0.5-10mm <sup>2</sup>

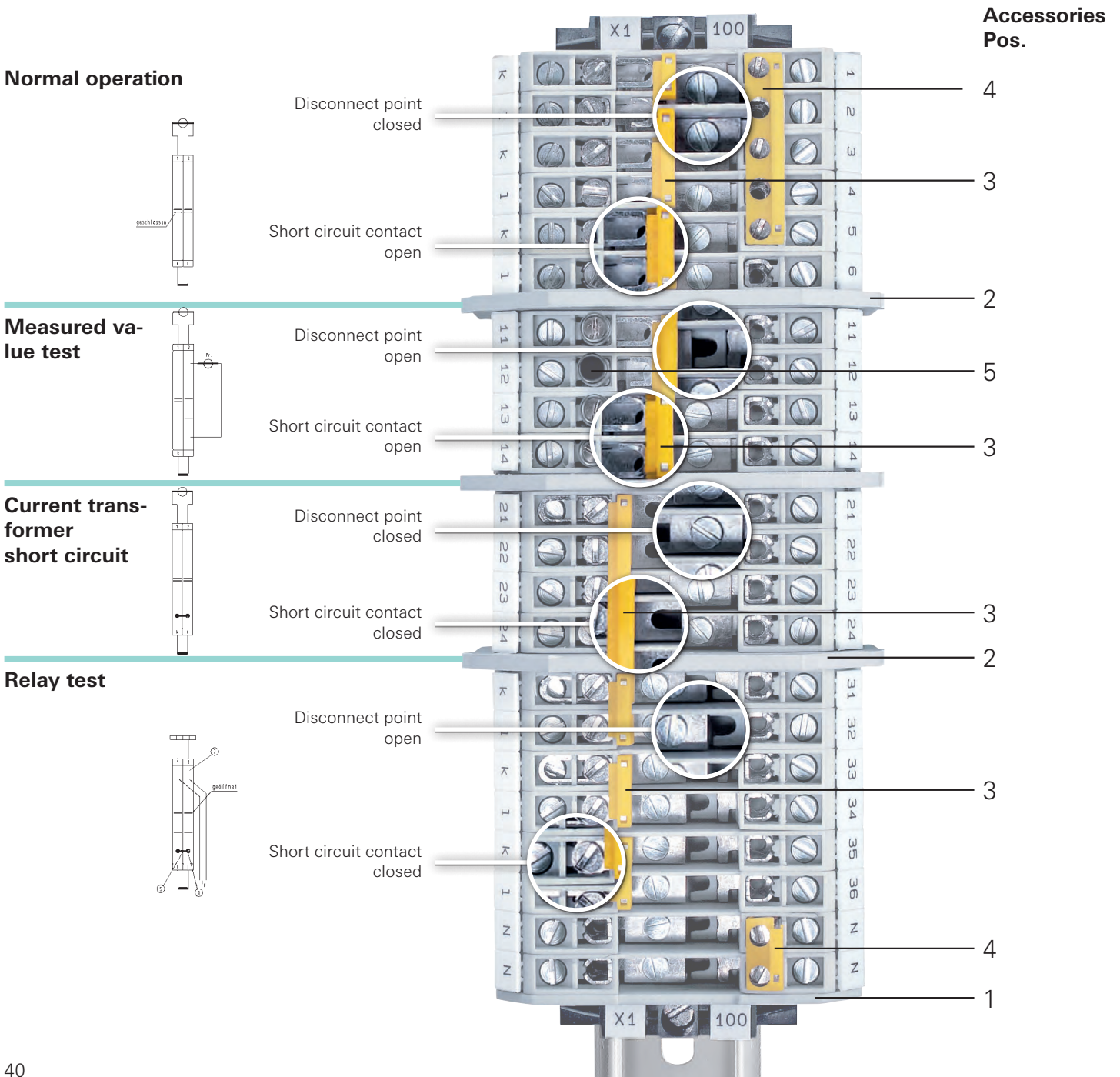



**WKN 6 TK**

- Instrument isolating terminal for mounting on TS 35
- Nominal cross section 6 mm<sup>2</sup>

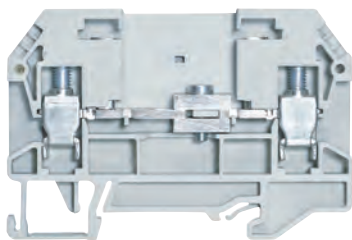

Description	Type	Part No.	Std. Pack
Instrument isolating terminal	WKN6 TK	56.106.0055.0	50
Feed-through block	WKN6 TK D	56.106.0155.0	50
<b>General data</b>			
Width / length / height, incl. TS 7.5	8 mm / 73 mm / 58 mm		
Wire strip length	12 mm		
Approvals			
<b>Technical data</b>	<b>IEC</b>	<b>UL</b>	<b>CSA</b>
	EN 60947-7-1		
Cross section fine-stranded	0.5–6 mm <sup>2</sup>		
Cross section solid/stranded	0.5–10 mm <sup>2</sup>		
Cross section, AWG			
Rated current	57 A		
Rated voltage	500 V		
Rated impulse voltage	6 kV		
Pollution degree	3		

**WKN 6 TK SF**

- Instrument isolating terminal with spring support for mounting on TS 35
- Nominal cross section 6 mm<sup>2</sup>

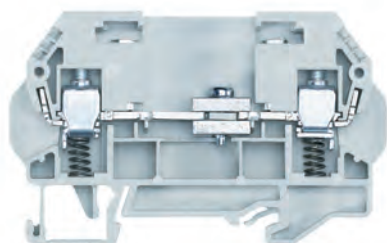

Description	Type	Part No.	Std. Pack
Instrument isolating terminal	WKN6 TK SF	56.106.0755.0	50
Feed-through block	WKN6 TK SFD	56.106.0855.0	50
<b>General data</b>			
Width / length / height, incl. TS 7.5	8 mm / 73 mm / 58 mm		
Wire strip length	12 mm		
Approvals			
<b>Technical data</b>	<b>IEC</b>	<b>EA TS 50-18</b>	
	EN 60947-7-1		
Cross section fine-stranded	0.5–6 mm <sup>2</sup>		
Cross section solid/stranded	0.5–10 mm <sup>2</sup>		
Cross section, AWG			
Rated current	57 A	25 A	
Rated voltage	500 V	500 V	
Rated impulse voltage	6 kV		
Pollution degree	3		

**Accessories for selos WKN 6 TK...**

Accessories	Type	Part No.	Std. Pack
1. End plate 2 mm	APN 6 TK	07.313.1755.0	10
2. Partition	TW 6 TK	07.312.0453.0	10
3. Sliding short-circuit slide, insulated	2 pole	IVS WKN6 TK-2	Z7.282.7229.0
	3 pole	IVS WKN6 TK-3	Z7.282.7329.0
	4 pole	IVS WKN6 TK-4	Z7.282.7429.0
	4. Cross connector with screws, insulated	2 pole	IVB WKN6 TK-2
	3 pole	IVB WKN6 TK-3	Z7.282.6329.0
	4 pole	IVB WKN6 TK-4	Z7.282.6429.0
	5 pole	IVB WKN6 TK-5	Z7.282.6529.0
	6 pole	IVB WKN6 TK-6	Z7.282.6629.0
5. Test socket	gray	SBN 4 GRAU	Z5.511.3553.0
	violet	SBN 4 VIOLETT	Z5.511.3553.9
	green	SBN 4 GRÜN	Z5.511.3553.7
	yellow	SBN 4 GELB	Z5.511.3553.8
	blue	SBN 4 BLAU	Z5.511.3553.6
6. Disconnect locking device	SP WKN 6 TK	05.566.6855.9	50
Jumper comb for WKN 6 TK	2 pole	IVK WKN 6TK-2	Z7.255.8227.0
	3 pole	IVK WKN 6TK-3	Z7.255.8327.0
	4 pole	IVK WKN 6TK-4	Z7.255.8427.0
	5 pole	IVK WKN 6TK-5	Z7.255.8527.0
	6 pole	IVK WKN 6TK-6	Z7.255.8627.0

# Instrument isolating terminal with screw connection WK6 TK



Wieland Electric's **selos** WK 6 TK block offers an optimal DIN rail block solution for all types of measuring circuits of current, voltage or energy. All circuits occurring during everyday practice can be implemented with the Instrument isolating terminal and a few accessories.

Complete insulated selectable connecting links are available as standard, as are insulated test sockets in all conventional signal colors. Two additional jumpering facilities permit the installation of fixed cross connections (e.g., for internal distribution of the k point of converter circuits). Standard cross connectors in a wide variety of numbers of pins are available for this purpose. The jumpers are easy to disconnect so that you can skip over blocks.

**Technical data as per EN 60947-7:**

Rated cross section:	6mm <sup>2</sup>	Rated current:	32A
Rated voltage:	400V	Connection capacity:	0.5-10mm <sup>2</sup>

**Normal operation**



Disconnect point closed

Short circuit contact open

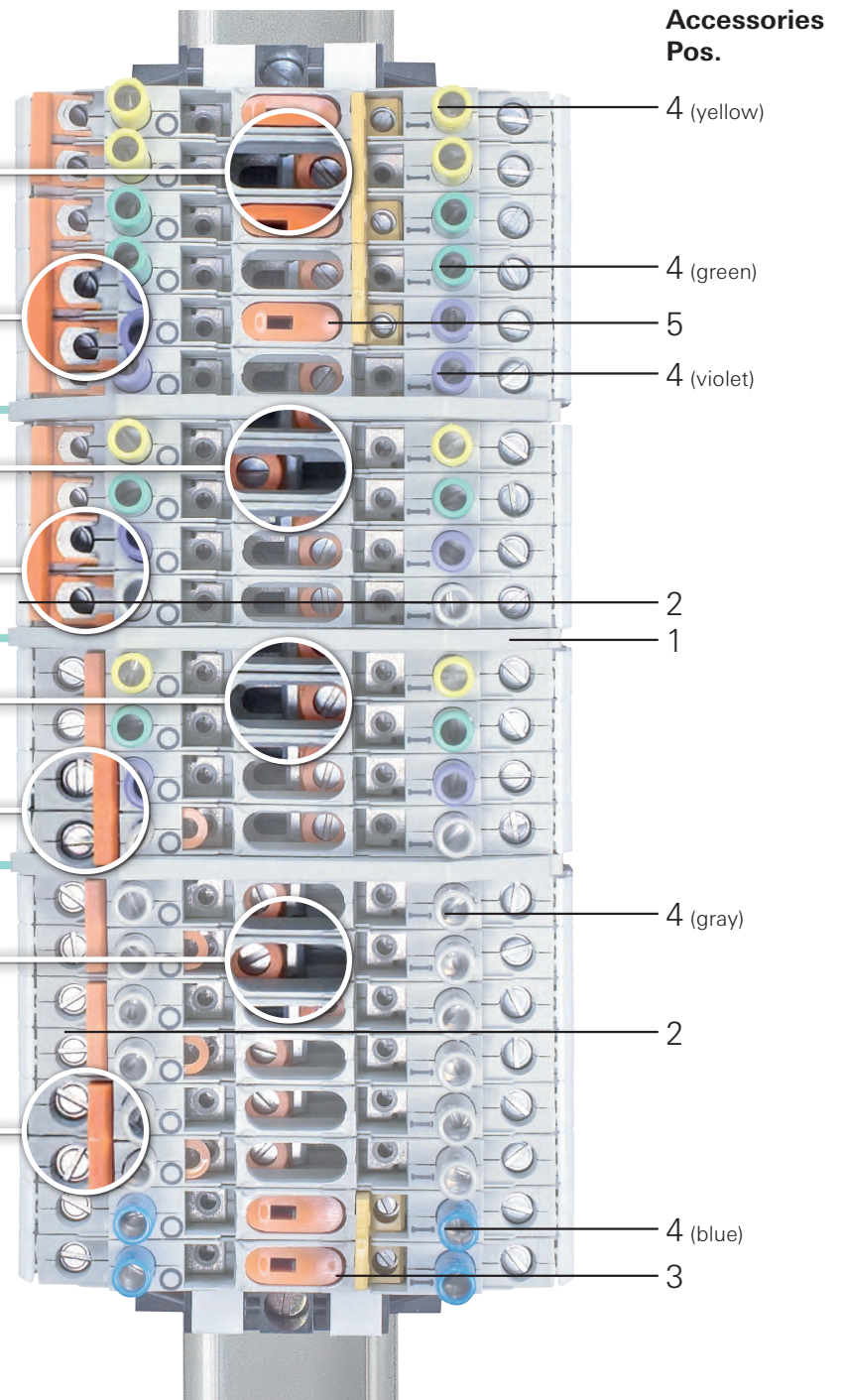

**Accessories Pos.**

4 (yellow)

4 (green)

5

4 (violet)

2

1

4 (gray)

2

4 (blue)

3

**Measured value test**

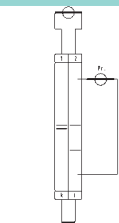

Disconnect point open

Short circuit contact open

**Current transformer short circuit**



Disconnect point closed

Short circuit contact closed

**Relay test**

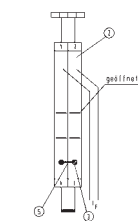

Disconnect point open

Short circuit contact closed

Description	Type	Part No.	Std. Pack	
				Instrument isolating terminal
<b>General data</b>				
Width / length / height, incl. TS 7.5	8 mm / 87 mm / 49 mm			
Wire strip length	12 mm			
Approvals				
<b>Technical data</b>		<b>IEC</b>	<b>UL</b>	<b>CSA</b>
For use with insulating sleeves	EN 60947-7-1			
Cross section fine-stranded	0.5–6 mm <sup>2</sup>			
Cross section solid/stranded	0.5–10 mm <sup>2</sup>			
Cross section, AWG	20–8			
Rated current	32 A	45 A	45 A	
Rated voltage	400 V	600 V	300 V	
Rated impulse voltage	6 kV			
Pollution degree	3			

**WK6 TK/35**

- Instrument isolating terminal for mounting on TS 35
- Nominal cross section 6 mm<sup>2</sup>



Description	Type	Part No.	Std. Pack	
				Instrument isolating terminal
<b>General data</b>				
Width / length / height, incl. TS 7.5	8 mm / 87 mm / 62 mm			
Wire strip length	12 mm			
Approvals				
<b>Technical data</b>		<b>IEC</b>	<b>UL</b>	<b>CSA</b>
For use with insulating sleeves	EN 60947-7-1			
Cross section fine-stranded	0.5–6 mm <sup>2</sup>			
Cross section solid/stranded	0.5–10 mm <sup>2</sup>			
Cross section, AWG	20–8			
Rated current	32 A	45 A	45 A	
Rated voltage	400 V	600 V	300 V	
Rated impulse voltage	6 kV			
Pollution degree	3			

**WK6 TK P3/35**

- Instrument isolating terminal with mounted test sockets for mounting on TS 35
- Nominal cross section 6 mm<sup>2</sup>

**Accessories for selos WK6 TK.../35**

Accessories	Type	Part No.	Std. Pack	
1. Partition	TW 6 TK	07.312.0453.0	10	
2. Sliding short-circuit slide, insulated	2 pole	IVS WK6 TK-2	Z7.212.2227.0	50
	3 pole	IVS WK6 TK-3	Z7.212.2327.0	50
	4 pole	IVS WK6 TK-4	Z7.212.2427.0	50
3. Cross connector with screws, insulated	2 pole	IVB WK6 TK-2	Z7.212.1227.0	50
	3 pole	IVB WK6 TK-3	Z7.212.1327.0	50
	4 pole	IVB WK6 TK-4	Z7.212.1427.0	50
	5 pole	IVB WK6 TK-5	Z7.212.1527.0	50
	10 pole	IVB WK6 TK-10	Z7.212.2027.0	50
4. Test socket	gray	SB 4 GRAU	05.511.2953.0	10
	violet	SB 4 VIOLETT	05.511.2953.9	10
	green	SB 4 GRÜN	05.511.2953.7	10
	yellow	SB 4 GELB	05.511.2953.8	10
5. Disconnect locking device	blue	SB 4 BLAU	05.511.2953.6	10
		SP WK6 TK	05.563.5453.0	50

## Screw type terminal blocks with spring support

### WKN 6 SF

- Feed-through block with spring support for mounting on TS 35 and TS 32
- Nominal cross section 6 mm<sup>2</sup>



Description	Type	Part No.	Std. Pack
Feed-through block, gray	WKN 6 SF	57.506.0555.0	100
<b>General data</b>			
Width / length / height, incl. TS 7.5	8 mm / 54 mm / 57 mm		
Wire strip length	11 mm		
Approvals			
<b>Technical data</b>	<b>IEC</b>	<b>EA TS 50-18</b>	
	EN 60947-7-1		
Cross section fine-stranded	0.5–6 mm <sup>2</sup>		
Cross section solid/stranded	0.5–10 mm <sup>2</sup>		
Cross section, AWG			
Rated current	41 A	30 A	
Rated voltage	800 V	500 V	
Rated impulse voltage	8 kV		
Pollution degree	3		
<b>Accessories</b>			
End plate, gray	APN 6 SF	07.313.2355.0	10
Partition, gray	TW 6 TK	07.312.0453.0	10
Cross connector with screws	2 pole	IVB WK 6 - 2	10
insulated	3 pole	IVB WK 6 - 3	10
	up to 12 pole	IVB WK 6 - 12	10
Single cover f. cross conn. with marking facility		AD VB 6 GELB	10
Cover with warning symbol	yellow	AD VB 8/4 GELB	10



### WKN 10 SF



- Feed-through block with spring support for mounting on TS 35 and TS 32
- Nominal cross section 10 mm<sup>2</sup>



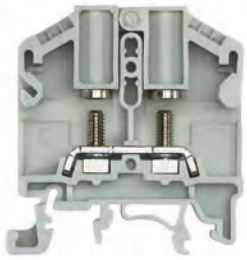

Description	Type	Part No.	Std. Pack
Feed-through block, gray	WKN 10 SF	57.510.0555.0	100
<b>General data</b>			
Width / length / height, incl. TS 7.5	10 mm / 55 mm / 64 mm		
Wire strip length	13 mm		
Approvals			
<b>Technical data</b>	<b>IEC</b>	<b>EA TS 50-18</b>	
	EN 60947-7-1		
Cross section fine-stranded	2.5–10 mm <sup>2</sup>		
Cross section solid/stranded	1.5–16 mm <sup>2</sup>		
Cross section, AWG			
Rated current	57 A	30 A	
Rated voltage	800 V	500 V	
Rated impulse voltage	8 kV		
Pollution degree	3		
<b>Accessories</b>			
End plate, gray	APN 10 SF	07.313.2455.0	10
Partition, gray	TW 6 TK	07.312.0453.0	10
Cross connector with screws	2 pole	IVB WK 10 - 2	10
insulated	3 pole	IVB WK 10 - 3	10
	up to 12 pole	IVB WK 10 - 12	10
Single cover f. cross conn. with marking facility		AD VB 10 GELB	10
Cover with warning symbol	yellow	AD VB 10/4 GELB	10

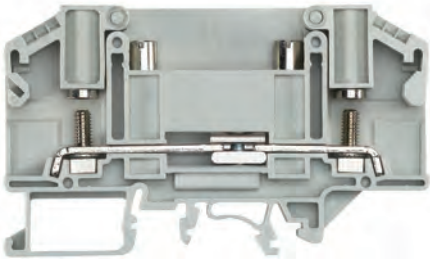
## DIN rail terminal blocks with ring lug connection

WRT 6		Description	Type	Part No.	Std. Pack	
<p>• Feed-through block with ring lug connection for mounting on TS 35</p> <p>• Nominal cross section 6 mm<sup>2</sup></p> 		Feed-through block, gray	WRT 6	57.106.1155.0	100	
		<b>General data</b>				
		Width / length / height, incl. TS 7.5	11 mm / 49 mm / 51 mm			
		Wire strip length	10 mm			
		Approvals				
		<b>Technical data</b>		<b>IEC</b>	<b>UL</b>	<b>CSA</b>
			EN 60947-7-1			
		Cross section fine-stranded	1.5–6 mm <sup>2</sup>			
		Cross section solid/stranded	1.5–6 mm <sup>2</sup>			
		Cross section, AWG	22–8			
		Rated current	41 A	50 A	50 A	
		Rated voltage	1000 V	600 V	600 V	
		Rated impulse voltage	8 kV			
Pollution degree	3					
<b>Accessories</b>		Type	Part No.	Std. Pack		
End plate, gray	APRT 6		07.300.6955.0	10		
Partition, gray	TW 6 TK		07.312.0453.0	10		
Cross connector, insulated	2 pole	IVB WRT 6 TK - 2	Z7.250.5227.0	10		
	3 pole	IVB WRT 6 TK - 3	Z7.250.5327.0	10		
	4 pole	IVB WRT 6 TK - 4	Z7.250.5427.0	10		

WRT 6 TK		Description	Type	Part No.	Std. Pack	
<p>• Instrument isolating terminal with ring lug connection for mounting on TS 35</p> <p>• Nominal cross section 6 mm<sup>2</sup></p> 		Instrument isolating terminal, gray	WRT 6 TK	57.106.1055.0	100	
		<b>General data</b>				
		Width / length / height, incl. TS 7.5	11 mm / 86 mm / 51 mm			
		Wire strip length	10 mm			
		Approvals				
		<b>Technical data</b>		<b>IEC</b>	<b>UL</b>	<b>CSA</b>
			EN 60947-7-1			
		Cross section fine-stranded	1.5–6 mm <sup>2</sup>			
		Cross section solid/stranded	1.5–6 mm <sup>2</sup>			
		Cross section, AWG	22–8			
		Rated current	41 A	35 A	35 A	
		Rated voltage	1000 V	600 V	600 V	
		Rated impulse voltage	8 kV			
Pollution degree	3					
<b>Accessories</b>		Type	Part No.	Std. Pack		
End plate, gray	APRT 6 TK		07.300.7055.0	10		
Partition, gray	TW 6 TK		07.312.0453.0	10		
Cross connector, insulated	2 pole	IVB WRT 6 TK - 2	Z7.250.5227.0	10		
	3 pole	IVB WRT 6 TK - 3	Z7.250.5327.0	10		
	4 pole	IVB WRT 6 TK - 4	Z7.250.5427.0	10		

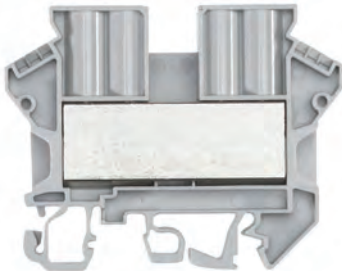
## DIN rail terminal with double clamping screw

WKN 16 DS		Description	Type	Part No.	Std. Pack	
<p>• Feed-through block with double screw connection for mounting on TS 32 and 35</p> <p>• Nominal cross section 16 mm<sup>2</sup></p> 		Feed-through block, gray	WKN 16 DS	57.016.5055.0	50	
		<b>General data</b>				
		Width / length / height, incl. TS 7.5	10 mm / 68 mm / 54 mm			
		Wire strip length	18 mm			
		Approvals				
		<b>Technical data</b>		<b>IEC</b>	<b>UL</b>	<b>CSA</b>
			EN 60947-7-1			
		Cross section fine-stranded	1.5–16 mm <sup>2</sup>			
		Cross section solid/stranded	1.5–25 mm <sup>2</sup>			
		Cross section, AWG	16–6			
		Rated current	76 A	65 A	65 A	
		Rated voltage	800 V		600 V	
		Rated impulse voltage	8 kV			
Pollution degree	3					
<b>Accessories</b>		Type	Part No.	Std. Pack		
End plate, gray	APN 16 DS		07.313.2255.0	10		
Cross connector, insulated	2 pole	IVB WKN 10 - 2	Z7.283.2227.0	10		
	3 pole	IVB WKN 10 - 3	Z7.283.2327.0	10		
	12 pole	IVB WKN 10 - 12	Z7.283.3227.0	10		



# **selos WRT** – the new generation of **high current terminals**

The **selos** WRT high current terminals are the new generation of ring lug terminals for safe and maintenance-free energy transmission.

A broad range and a clear focus on customer benefits makes **selos** WRT a robust solution for connecting conductors to 300 mm<sup>2</sup> and 520 A.

## **Features**

- Rugged design
- Safe and maintenance-free
- Flexible potential distribution
- Reliable touch protection

## **Safe and maintenance-free**

- High performance
- Up to 300 mm<sup>2</sup> / 520 A / 1000 V
- Maintenance-free screw connection
- Vibration-proof

## **Simple mounting**

- On TS 35 or on the mounting plate
- Few parts - nut with integrated spring washer

## **Touch-proof application**

- Cover easy to open and close
- Test opening – completely touch-proof voltage measurement
- Cover can be individually adapted

## **Flexible potential distribution**

- Cross connectors for simple potential distribution up to nominal currents
- Multi-conductor connection possible, 2 cable lugs per connection point

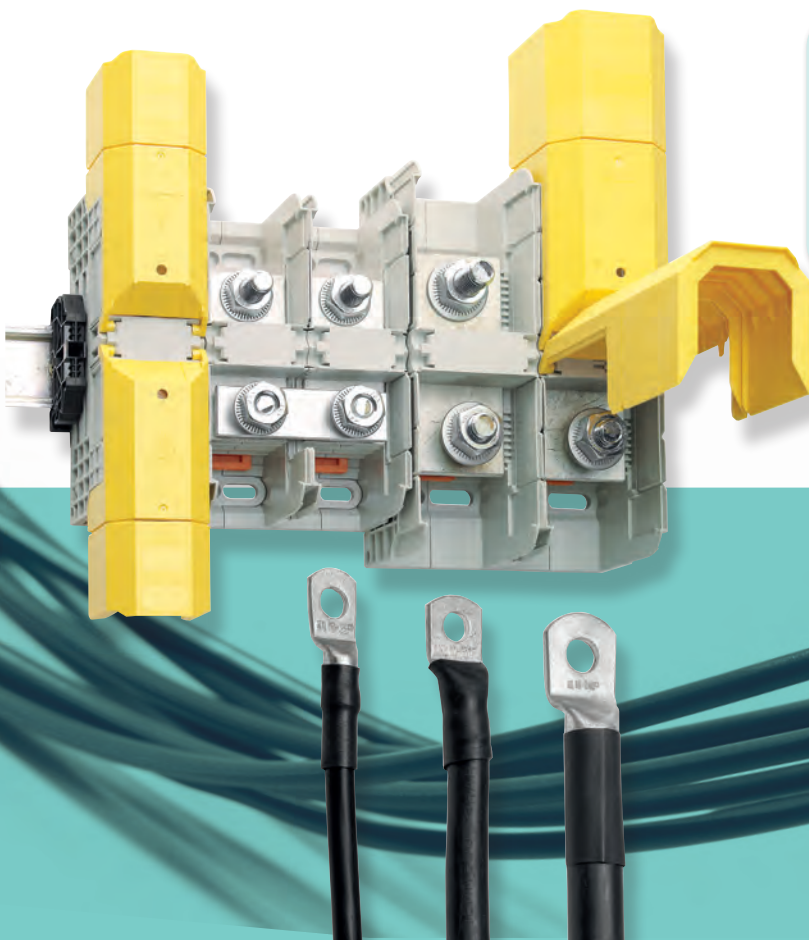

## High current terminals with screw connection

### WRT 35

- High current terminal block for mounting on TS 35
- Nominal cross-section 35 mm<sup>2</sup>
- Bolt connection M6



Description	Type	Part No.	Std. Pack
High current terminal block	WRT 35 / M6	56.135.1055.0	10
<b>General data</b>			
Width / length / height (incl. TS 7.5)	27 mm / 107 mm / 51 mm		
Width / length / height (incl. TS 7.5 & cover)	27 mm / 131 mm / 60 mm		
Screw size	M6		
Approvals			
<b>Technical data</b>		<b>IEC</b>	<b>UL</b>
Cross section fine-stranded	2.5 - 50 mm <sup>2</sup>		
Cross section solid/stranded	2.5 - 50 mm <sup>2</sup>		
Cross-section, AWG		14 - 2	14 - 2
Rated current	125 A	130 A	130 A
Rated voltage	1000 V	1000 V	1000 V
Rated impulse voltage	8 kV		
Pollution degree	3		
Torque	3 - 6 Nm		
<b>Accessories</b>			
Cover (2 piece/terminal required)	AD WRT 35	07.431.7053.8	20
Cross connector, for 2 terminals	VB WRT 35-2	07.201.1227.6	5
Cross connector, for 3 terminals	VB WRT 35-3	07.201.1327.6	5

### WRT 70

- High current terminal block for mounting on TS 35
- Nominal cross-section 70 mm<sup>2</sup>
- Bolt connection M8



Description	Type	Part No.	Std. Pack
High current terminal block	WRT 70	56.170.1055.0	10
<b>General data</b>			
Width / length / height (incl. TS 7.5)	32 mm / 132 mm / 61 mm		
Width / length / height (incl. TS 7.5 & cover)	32 mm / 180 mm / 70 mm		
Screw size	M8		
Approvals			
<b>Technical data</b>		<b>IEC</b>	<b>UL</b>
Cross section fine-stranded	2.5 - 95 mm <sup>2</sup>		
Cross section solid/stranded	2.5 - 95 mm <sup>2</sup>		
Cross-section, AWG		14 - 00	14 - 00
Rated current	192 A	175 A	170 A
Rated voltage	1000 V	1000 V	1000 V
Rated impulse voltage	8 kV		
Pollution degree	3		
Torque	6 - 12 Nm		
<b>Accessories</b>			
Cover (2 piece/terminal required)	AD WRT 70	07.431.7153.8	20
Cross connector, for 2 terminals	VB WRT 70-2	07.201.3227.6	5
Cross connector, for 3 terminals	VB WRT 70-3	07.201.3327.6	5

### WRT 120

- High current terminal block for mounting on TS 35
- Nominal cross-section 120 mm<sup>2</sup>
- Bolt connection M10



Description	Type	Part No.	Std. Pack
High current terminal block	WRT 120	56.197.1055.0	5
<b>General data</b>			
Width / length / height (incl. TS 7.5)	42 mm / 133 mm / 72 mm		
Width / length / height (incl. TS 7.5 & cover)	42 mm / 226 mm / 80 mm		
Screw size	M10		
Approvals			
<b>Technical data</b>		<b>IEC</b>	<b>UL</b>
Cross section fine-stranded	to 120 mm <sup>2</sup>		
Cross section solid/stranded	6 - 150 mm <sup>2</sup>		
Cross-section, AWG		10 - 250 kcmil	10 - 250 kcmil
Rated current	269 A	310 A	310 A
Rated voltage	1000 V	1000 V	1000 V
Rated impulse voltage	8 kV		
Pollution degree	3		
Torque	10 - 20 Nm		
<b>Accessories</b>			
Cover (2 piece/terminal required)	AD WRT 120	07.431.7253.8	10
Cross connector, for 2 terminals	VB WRT 120-2	07.201.5227.6	5
Cross connector, for 3 terminals	VB WRT 120-3	07.201.5327.6	5



### WRT 185

- High current terminal block for mounting on TS 35
- Nominal cross-section 185 mm<sup>2</sup>
- Bolt connection M12



Description	Type	Part No.	Std. Pack
High current terminal block	WRT 185	56.198.1055.0	5

General data			
Width / length / height (incl. TS 7.5)	55 mm / 164 mm / 78 mm		
Width / length / height (incl. TS 7.5 & cover)	55 mm / 288 mm / 90 mm		
Screw size	M12		
Approvals			

Technical data	IEC	UL	CSA
Cross section fine-stranded	to 185 mm <sup>2</sup>		
Cross section solid/stranded	10 - 240 mm <sup>2</sup>		
Cross-section, AWG		10 - 500 kcmil	10 - 500 kcmil
Rated current	353 A	380 A	380 A
Rated voltage	1000 V	1000 V	1000 V
Rated impulse voltage	8 kV		
Pollution degree	3		
Torque	14 - 31 Nm		

Description	Type	Part No.	Std. Pack
-------------	------	----------	-----------

Accessories			
Cover (2 piece/terminal required)	AD WRT 185/300	07.431.7353.8	10
Cross connector, for 2 terminals	VB WRT 185-2	07.201.7227.6	5
Cross connector, for 3 terminals	VB WRT 185-3	07.201.7327.6	5

### WRT 300

- High current terminal block for mounting on TS 35
- Nominal cross-section 300 mm<sup>2</sup>
- Bolt connection M16



Description	Type	Part No.	Std. Pack
High current terminal block	WRT 300	56.199.1055.0	5

General data			
Width / length / height (incl. TS 7.5)	55 mm / 164 mm / 78 mm		
Width / length / height (incl. TS 7.5 & cover)	55 mm / 288 mm / 90 mm		
Screw size	M16		
Approvals			

Technical data	IEC	UL	CSA
Cross section fine-stranded	to 300 mm <sup>2</sup>		
Cross section solid/stranded	25 - 240 mm <sup>2</sup>		
Cross-section, AWG		10 - 600 kcmil	10 - 600 kcmil
Rated current	520 A	510 A	510 A
Rated voltage	1000 V	1000 V	1000 V
Rated impulse voltage	8 kV		
Pollution degree	3		
Torque	25 - 60 Nm		

Description	Type	Part No.	Std. Pack
-------------	------	----------	-----------

Accessories			
Cover (2 piece/terminal required)	AD WRT 185/300	07.431.7353.8	10
Cross connector, for 2 terminals	VB WRT 300-2	07.201.9227.6	5
Cross connector, for 3 terminals	VB WRT 300-3	07.201.9327.6	5

## High current terminal blocks with screw connection

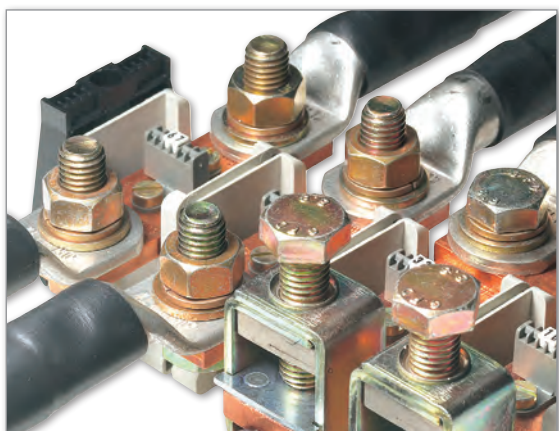

**selos** POWER LINE is designed for use in mechanical and plant engineering, railway, and battery applications.

Wieland offers a program which was especially developed for high current applications. The portfolio includes feed through blocks and ring lug terminals. The RFK type feed through blocks include four different cross sections between 95 and 240 mm<sup>2</sup> with different types of connection (e.g., rising cage or ring lug connection).

Ring lug terminals augment the **selos** POWER LINE product line. Blocks with ring lug sizes from M 6 to M 12 are available for the connection of wires with crimped cable lugs.

Extensive accessories optimize the **selos** POWER LINE for a wide variety of applications.

**Technical data as per EN 60947-7:**

Rated cross section: 95 mm<sup>2</sup> - 240 mm<sup>2</sup>

Rated current: up to 415A

Rated voltage: 1000V

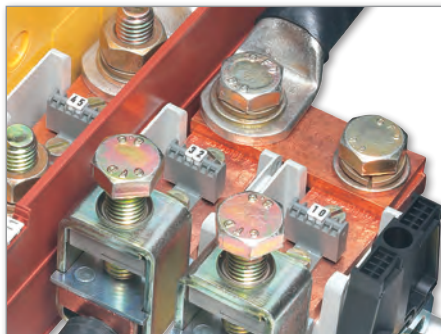

**High current blocks, type RFK**

- Up to 240 mm<sup>2</sup> rated cross section
- Cable connection via ring lug connection technology, direct connection with rising cage or hybrid solutions
- Current carrying and cross connectors made of E-Cu
- Screws maintain torque via clamping body design, as well as lock washers



**Lug ring connection blocks**

- For the connection of cable lugs in versions from M 6 to M 12
- Screws maintain torque via lock washers
- Approved for international rail transportation standards



**Accessories for selos POWER**

- Covers for provision of protection against accidental touch
- Cross connectors made of E-Cu; 2, 3 and 4-pole
- Partition plates for visual and electrical separation
- All components can be marked with the standard Wieland marking system

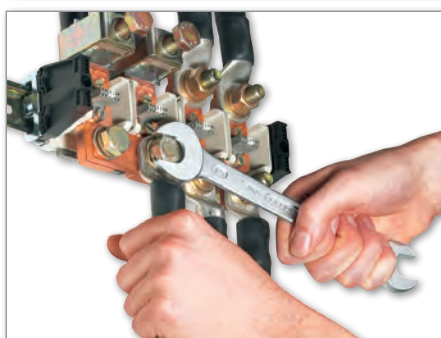

**Mounting notice**

- When tightening the block screws, we recommend countering by holding the wire to avoid deformation of the mounting rail and to keep the foot of the block free of torsional forces.

### BK M .../35

- Ring lug terminal for mounting on TS 35



Description	Type	Part No.	Std. Pack	
Ring lug terminal	BK M 6/35	32.530.0053.0	25	
	BK M 8/35	32.540.0053.0	25	
	BK M 10/35	32.550.0053.0	25	
	BK M 12/35	32.560.0053.0	25	
<b>General data</b>				
Approvals				
<b>Technical data</b>	<b>BK M 6</b>	<b>BK M 8</b>	<b>BK M 10</b> <b>BK M 12</b>	
Width / height	19 x 56	24 x 65	35 x 72    35 x 74	
Rated current	125 A	150 A	265 A    265 A	
Rated voltage	1000 V / 8 kV / 3 with partition TW BK			
<b>Accessories</b>				
	Type	Part No.	Std. Pack	
Partition	for BK M 6	TW BK M 6/35	07.340.3553.0	25
	for BK M 8	TW BK M 8/35	07.340.3653.0	25
	for BK M 10	TW BK M 10-12/35	07.340.3753.0	25
	for BK M 12	TW BK M 10-12/35	07.340.3753.0	25
Cross connector for tab connection blocks, from E-Cu				
	for 2 blocks BK M 6	VB BK M 6/35-2	07.205.5227.0	20
	for 3 blocks BK M 6	VB BK M 6/35-3	07.205.5327.0	10
	for 2 blocks BK M 8	VB BK M 8/35-2	07.205.7227.0	20
	for 3 blocks BK M 8	VB BK M 8/35-3	07.205.7327.0	10
	for 2 blocks BK M 10	VB BK M 10/35-2	07.205.8227.0	20
	for 3 blocks BK M 10	VB BK M 10/35-3	07.205.8327.0	10
	for 2 blocks BK M 12	VB BK M 12/35-2	07.205.9227.0	20
	for 3 blocks BK M 12	VB BK M 12/35-3	07.205.9327.0	10
Cover				
	for BK M 6	AD BK M 6-8/35	04.304.0181.0	1
	for BK M 8	AD BK M 6-8/35	04.304.0181.0	1
	for BK M 10	AD BK M 10-12/35	04.304.0281.0	1
	for BK M 12	AD BK M 10-12/35	04.304.0281.0	1
Installation clip for cover			05.564.0753.0	10

## High current blocks with screw connection

### RFK 1/95... S35

- High current block for mounting on TS 35
- Nominal cross section 95 mm<sup>2</sup>

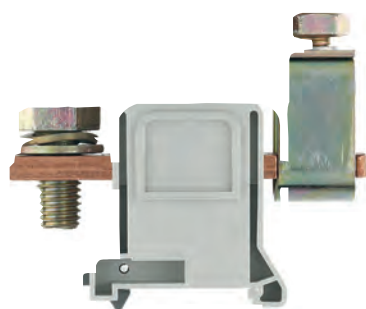

Description	Type	Part No.	Std. Pack
Feed-through block, gray	<b>F</b> RFK 1/95 F S 35	56.395.0055.0	10
	<b>K</b> RFK 1/95 K S 35	56.395.0155.0	10
	<b>FK</b> RFK 1/95 FK S 35	56.395.0255.0	10
	<b>FM</b> RFK 1/95 FM S 35	56.395.1055.0	10
	<b>FMK</b> RFK 1/95 FMK S 35	56.395.1255.0	10

General data			
Width / length / height, incl. TS 7.5	see list p. 53		
Wire strip length	27 mm		
Approvals			
Technical data	IEC	UL	CSA
	EN 60947-7-1		
Cross section fine-stranded	16–95 mm <sup>2</sup>		
Cross section solid/stranded	16–95 mm <sup>2</sup>		
Cross section, AWG		6-3/0	6-3/0
Rated current	250 A	200 A	200 A
Rated voltage	1000 V	600 V	600 V
Rated impulse voltage	8 kV		
Pollution degree	3		
Accessories	Type	Part No.	Std. Pack
Cover for RFK 1/..., yellow	AD RFK 95	Z7.409.5753.0	10
Partition/end plate 2.8mm thick	TE/RFK 1/95	07.340.0353.0	50
Cross connector, for 2 blocks	VB RFK 1/95/2/32	07.205.1227.0	20
from E-Cu for 3 blocks	VB RFK 1/95/3/32	07.205.1327.0	10
for 4 blocks	VB RFK 1/95/4/32	07.205.1427.0	10

### RFK 1/150... S35

- High current block for mounting on TS 35
- Nominal cross section 150 mm<sup>2</sup>

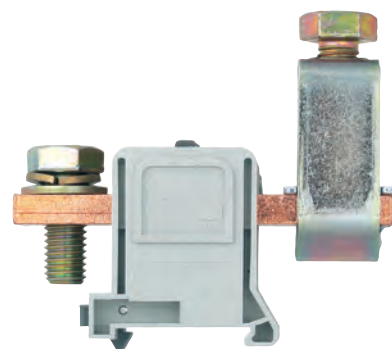

Description	Type	Part No.	Std. Pack
Feed-through block, gray	<b>F</b> RFK 1/150 F S35	56.397.0055.0	10
	<b>K</b> RFK 1/150 K S35	56.397.0155.0	10
	<b>FK</b> RFK 1/150 FK S35	56.397.0255.0	10
	<b>FMK</b> RFK 1/150 FMK S35	56.397.1255.0	10

General data			
Width / length / height, incl. TS 7.5	see list p. 53		
Wire strip length	27 mm		
Approvals			
Technical data	IEC	UL	CSA
	EN 60947-7-1		
Cross section fine-stranded	70–150 mm <sup>2</sup>		
Cross section solid/stranded	70–150 mm <sup>2</sup>		
Cross section, AWG		0 - 300 kcmil	0 - 300 kcmil
Rated current	335 A	275 A	300 A
Rated voltage	1000 V	600 V	600 V
Rated impulse voltage	8 kV		
Pollution degree	3		
Accessories	Type	Part No.	Std. Pack
Cover for RFK 1/..., yellow	AD RFK 150 - 240	Z7.409.5853.0	10
Partition/end plate 2.8mm thick	TE/RFK 1/150 - 240 PA	07.340.1053.0	50
Cross connector, for 2 blocks	VB RFK 1/185/2	07.201.4227.0	10
from E-Cu for 3 blocks	VB RFK 1/185/3	07.201.4327.0	10
for 4 blocks	VB RFK 1/185/4	07.201.4427.0	10

### RFK 1/185... S35

- High current block for mounting on TS 35
- Nominal cross section 185 mm<sup>2</sup>

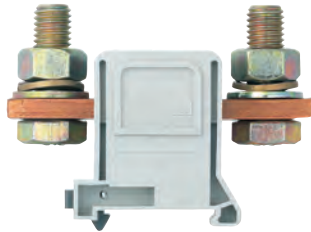

Description	Type	Part No.	Std. Pack
Feed-through block, gray	<b>F</b> RFK 1/185 F S 35	56.398.0055.0	10
	<b>FM</b> RFK 1/185 FM S 35	56.398.1055.0	10
<b>General data</b>			
Width / length / height, incl. TS 7.5	see list		
Wire strip length	27 mm		
Approvals			
<b>Technical data</b>		<b>IEC</b>	<b>UL</b>
For use with insulating sleeves	EN 60947-7-1		
Cross section fine-stranded	70–200 mm <sup>2</sup>		
Cross section solid/stranded	70–200 mm <sup>2</sup>		
Cross section, AWG		0 - 400 kcmil	0 - 400 kcmil
Rated current	353 A	375 A	375 A
Rated voltage	1000 V	600 V	600 V
Rated impulse voltage	8 kV		
Pollution degree	3		
<b>Accessories</b>			
Cover for RFK 1/..., yellow	Type AD RFK 150 - 240	Part No. Z7.409.5853.0	Std. Pack 10
Partition/end plate	2.8 mm thick TE/RFK 1/150 - 240 PA	07.340.1053.0	50
Cross connector, from E-Cu	for 2 blocks VB RFK 1/185/2	07.201.4227.0	10
	for 3 blocks VB RFK 1/185/3	07.201.4327.0	10
	for 4 blocks VB RFK 1/185/4	07.201.4427.0	10

### RFK 1/240... S35

- High current block for mounting on TS 35
  - Nominal cross section 240 mm<sup>2</sup>
- \*) Use only cable lugs type DIN 46234

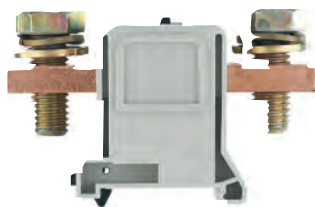

Description	Type	Part No.	Std. Pack
Feed-through block, gray	<b>F</b> RFK 1/240 F S 35*)	56.399.0055.0	10
	<b>K</b> RFK 1/240 K S 35	56.399.0155.0	10
	<b>FK</b> RFK 1/240 FK S 35*)	56.399.0255.0	10
	<b>FM</b> RFK 1/240 FM S 35*)	56.399.1055.0	10
	<b>FMK</b> RFK 1/240 FMK S 35*)	56.399.1255.0	10
<b>General data</b>			
Width / length / height, incl. TS 7.5	see list		
Wire strip length	27 mm		
Approvals			
<b>Technical data</b>		<b>IEC</b>	<b>UL</b>
For use with insulating sleeves	EN 60947-7-1		
Cross section fine-stranded	70–240 mm <sup>2</sup>		
Cross section solid/stranded	70–240 mm <sup>2</sup>		
Cross section, AWG		0 - 500 kcmil	3/0 - 500 kcmil
Rated current	415 A	375 A	425 A
Rated voltage	1000 V	600 V	600 V
Rated impulse voltage	8 kV		
Pollution degree	3		
<b>Accessories</b>			
Cover for RFK 1/..., yellow	Type AD RFK 150 - 240	Part No. Z7.409.5853.0	Std. Pack 10
Partition/end plate	2.8 mm thick TE/RFK 1/150 - 240 PA	07.340.1053.0	50
Cross connector, from E-Cu	for 2 blocks VB RFK 1/240/2	07.201.8227.0	10
	for 3 blocks VB RFK 1/240/3	07.201.8327.0	10
	for 4 blocks VB RFK 1/240/4	07.201.8427.0	10

## Configurations

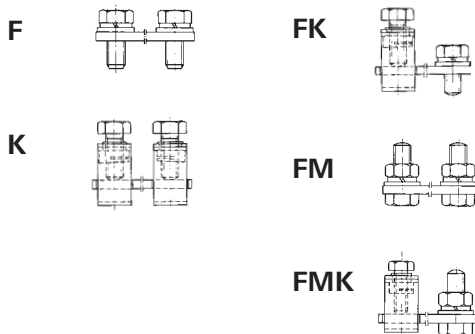



mm <sup>2</sup>	Type	Screw	Width mm	Length mm	Height, incl. TS 7.5 mm
95	F	M10	32	92	55
	FM	M10	32	92	65
	K, FK, FMK	M10	32	92	78
150	F	M12	42	92	55
	K, FK, FMK	M12	42	92	78
185	F	M12	42	92	55
	FM	M12	42	92	70
240	F	M12	42	92	55
	FM	M12	42	92	77
	K, FK, FMK	M12	42	92	93

## Mini blocks with screw connection for TS 15

### WKM 2,5/15

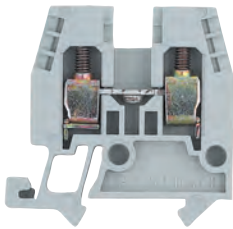
- Feed-through block for mounting on TS 15
- Nominal cross section 2.5 mm<sup>2</sup>
- Ex e I/II  II 2GD IM2  
Follow the EX installation instructions on page 149





Description	Type	Part No.	Std. Pack
Feed-through block, gray	WKM 2,5/15	55.503.1053.0	100
Feed-through block, blue	WKM 2,5/15 BLAU	55.503.1053.6	100
<b>General data</b>			
Width / length / height, incl. TS 7.5	5 mm / 32 mm / 32 mm		
Wire strip length	9 mm		
Approvals	 <span style="float: right;">KEMA 02 ATEX 2114 U</span>		
<b>Technical data</b>		<b>IEC</b>	<b>UL</b>
		<b>CSA</b>	
	EN 60 947-7-1		EN 60 079-0/-7
Cross section fine-stranded	0.5–2.5 mm <sup>2</sup>		0.5–2.5 mm <sup>2</sup>
Cross section solid/stranded	0.5–4 mm <sup>2</sup>		0.5–4 mm <sup>2</sup>
Cross section, AWG		22–14	24–12
Rated current	25 A	10 A	25 A
Rated voltage	500 V	300 V	600 V
Rated impulse voltage	6 kV		275 V
Pollution degree	3		
<b>Accessories</b>			
End plate	Type	Part No.	Std. Pack
	gray	APM 2,5 - 4/15	07.311.0853.0
	blue	APM 2,5 - 4/15 BLAU	07.311.0853.6
Partition	gray	TWM 2,5 - 4/15	07.311.1853.0
Cross connector with screws, E-Cu	2 pole	VB WKM 2,5/15-2	Z7.215.4227.0
	3 pole	VB WKM 2,5/15-3	Z7.215.4327.0
	up to 6 pole	VB WKM 2,5/15-6	Z7.215.4627.0
	60 pole	VB WKM 2,5/15 M60	Z7.215.4027.0
Single cover f. cross conn. with marking facility		AD VB 2,5/15 GELB	04.326.3053.8
Partition plate with marking facility		TSM 2,5/15	07.311.2853.8

### WKM 4/15

- Feed-through block for mounting on TS 15
- Nominal cross section 4 mm<sup>2</sup>
- Ex e I/II  II 2GD IM2  
Follow the EX installation instructions on page 149
- <sup>2)</sup> with/without jumper





Description	Type	Part No.	Std. Pack
Feed-through block, gray	WKM 4/15	55.504.1053.0	100
Feed-through block, blue	WKM 4/15 BLAU	55.504.1053.6	100
<b>General data</b>			
Width / length / height, incl. TS 7.5	6 mm / 32 mm / 32 mm		
Wire strip length	9 mm		
Approvals	 <span style="float: right;">KEMA 02 ATEX 2114 U</span>		
<b>Technical data</b>		<b>IEC</b>	<b>UL</b>
		<b>CSA</b>	
	EN 60 947-7-1		EN 60 079-0/-7
Cross section fine-stranded	0.5–4 mm <sup>2</sup>		0.5–4 mm <sup>2</sup>
Cross section solid/stranded	0.5–6 mm <sup>2</sup>		0.5–6 mm <sup>2</sup>
Cross section, AWG		22–10	20–10
Rated current	28 A	30 A	37 A
Rated voltage	500 V	600 V	600 V
Rated impulse voltage	6 kV		275 V
Pollution degree	3		
<b>Accessories</b>			
End plate	Type	Part No.	Std. Pack
	gray	APM 2,5 - 4/15	07.311.0853.0
	blue	APM 2,5 - 4/15 BLAU	07.311.0853.6
Partition	gray	TWM 2,5 - 4/15	07.311.1853.0
Cross connector with screws, E-Cu	2 pole	IVB WK 4 E/U-2	Z7.271.2227.0
	3 pole	IVB WK 4 E/U-3	Z7.271.2327.0
	up to 12 pole	IVB WK 4 E/U-12	Z7.271.3227.0
Single cover f. cross conn. with marking facility		AD VB 4/15 GELB	04.326.2953.8
Partition plate with marking facility		TSM 4/15	07.311.2953.8

### WKM 4 SL/15

- Ground block for mounting on TS 15
- Nominal cross section 4 mm<sup>2</sup>
- Ex e I/II  II 2GD IM2  
Follow the EX installation instructions on page 149



Description	Type	Part No.	Std. Pack
Ground block, green/yellow	WKM 4 SL/15	55.504.9153.0	100
<b>General data</b>			
Width / length / height, incl. TS 7.5	6 mm / 32 mm / 32 mm		
Wire strip length	9 mm		
Approvals	 <span style="float: right;">KEMA 02 ATEX 2114 U</span>		
<b>Technical data</b>		<b>IEC</b>	<b>UL</b>
		<b>CSA</b>	
	EN 60 947-7-2		EN 60 079-0/-7
Cross section fine-stranded	0.5–4 mm <sup>2</sup>		0.5–4 mm <sup>2</sup>
Cross section solid/stranded	0.5–6 mm <sup>2</sup>		0.5–6 mm <sup>2</sup>
Cross section, AWG		22–14	22–10
Rated current		30 A	
Rated voltage	500 V	300 V	
Rated impulse voltage	6 kV		
Pollution degree	3		
<b>Accessories</b>			
End plate	Type	Part No.	Std. Pack
		APM 4 SL/15	07.311.0753.0

### WKM 2,5 F1/15

- Feed-through block with solder connection for mounting on TS 15
- Nominal cross section 2.5 mm<sup>2</sup>
- The terminal blocks of series WKM 2,5 F1/15 and WKM 2,5 F2/15 must be mounted alternately in order to maintain the required air and creepage distances for the indicated rated voltage.

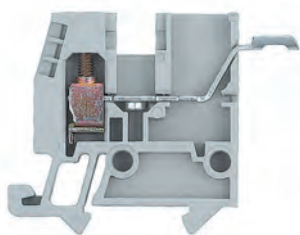

Description	Type	Part No.	Std. Pack
Feed-through block, gray	WKM 2,5 F1/15	55.503.1253.0	100
<b>General data</b>			
Width / length / height, incl. TS 7.5	5 mm / 32 mm / 32 mm		
Wire strip length	9 mm		
Approvals			
<b>Technical data</b>	<b>IEC</b>	<b>UL</b>	<b>CSA</b>
	EN 60 947-7-1		
Cross section fine-stranded	0.5–2.5 mm <sup>2</sup>		
Cross section solid/stranded	0.5–4 mm <sup>2</sup>		
Cross section, AWG			
Rated current	24 A		
Rated voltage	500 V		
Rated impulse voltage	6 kV		
Pollution degree	3		
<b>Accessories</b>			
End plate	gray	APM 2,5 F./15	07.311.0653.0
Cross connector with screws,	2 pole	VB WKM 2,5/15-2	Z7.215.4227.0
E-Cu	3 pole	VB WKM 2,5/15-3	Z7.215.4327.0
	up to 6 pole	VB WKM 2,5/15-6	Z7.215.4627.0
	60 pole	VB WKM 2,5/15 M60	Z7.215.4027.0
Single cover f. cross conn. with marking facility		AD VB 2,5/15 GELB	04.326.3053.8
Partition plate with marking facility	yellow	TSM 2,5/15	07.311.2853.8

### WKM 2,5 F2/15

- Feed-through block solder connection for mounting on TS 15
- Nominal cross section 2.5 mm<sup>2</sup>
- The terminal blocks of series WKM 2,5 F1/15 and WKM 2,5 F2/15 must be mounted alternately in order to maintain the required air and creepage distances for the indicated rated voltage.

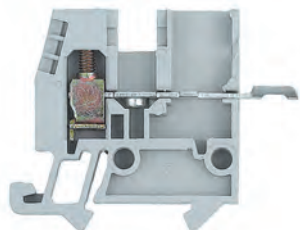

Description	Type	Part No.	Std. Pack
Feed-through block, gray	WKM 2,5 F2/15	55.503.1353.0	100
<b>General data</b>			
Width / length / height, incl. TS 7.5	5 mm / 32 mm / 32 mm		
Wire strip length	9 mm		
Approvals			
<b>Technical data</b>	<b>IEC</b>	<b>UL</b>	<b>CSA</b>
	EN 60 947-7-1		
Cross section fine-stranded	0.5–2.5 mm <sup>2</sup>		
Cross section solid/stranded	0.5–4 mm <sup>2</sup>		
Cross section, AWG			
Rated current	24 A		
Rated voltage	500 V		
Rated impulse voltage	6 kV		
Pollution degree	3		
<b>Accessories</b>			
End plate	gray	APM 2,5 F./15	07.311.0653.0
Cross connector with screws,	2 pole	VB WKM 2,5/15-2	Z7.215.4227.0
E-Cu	3 pole	VB WKM 2,5/15-3	Z7.215.4327.0
	up to 6 pole	VB WKM 2,5/15-6	Z7.215.4627.0
	60 pole	VB WKM 2,5/15 M60	Z7.215.4027.0
Single cover f. cross conn. with marking facility		AD VB 2,5/15 GELB	04.326.3053.8
Partition plate with marking facility	yellow	TSM 2,5/15	07.311.2853.8

## DIN rail terminal blocks with screw connection, type 9700 A.. S35

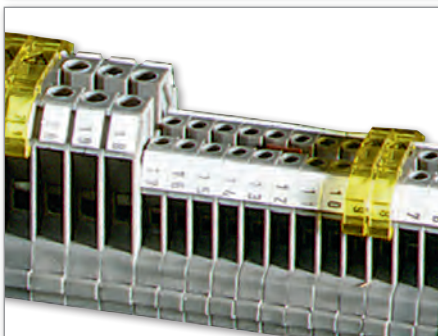
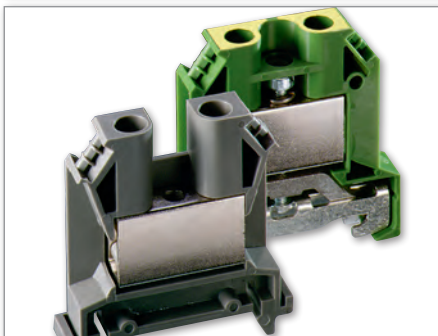
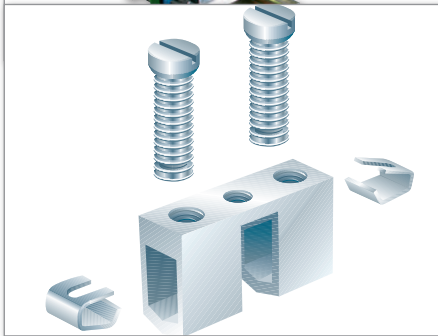
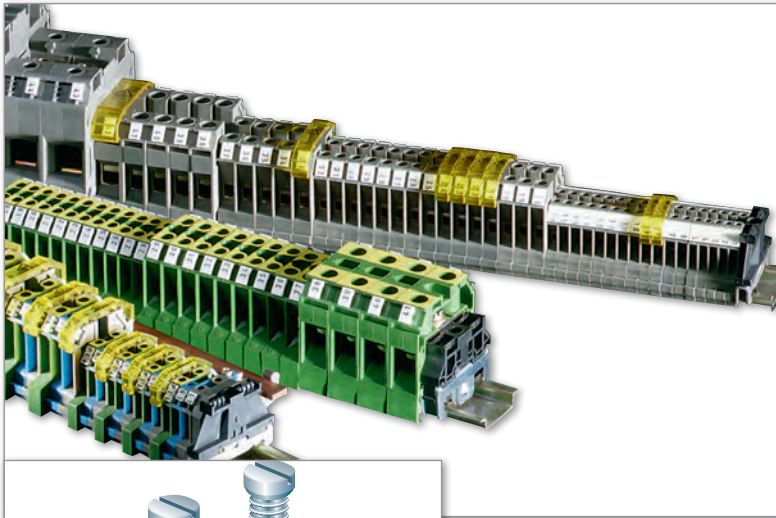

### DIN rail terminal blocks with screw connection – **selos** CLASSIC

The **selos** CLASSIC series offers the highest-quality connecting technology. Thanks to its unique clamping body design, aluminum or copper wire connections are long lasting and maintenance-free.

The product line includes feed-through and ground blocks for wires up to 50 mm<sup>2</sup>.

### High-quality screw connection technology

- Steel free clamping body
  - Increased corrosion resistance
  - Extruded clamping body, nickel-plated brass
- Low contact resistance
  - Clamping body has similar physical and chemical characteristics as the conductor
  - One piece clamping body/current bar

### Connection of aluminum wires possible

The following always applies when connecting aluminium wires in the **selos** CLASSIC LINE:

- After being stripped, the ends of the wires must be cleaned with a brush and then coated with acid-free grease to prevent further oxidation.
- The terminal should be tightened to approx. 20% higher torque than what is stated for the clamping screw.

With this type of terminal, it is not necessary to retighten the clamping screws.

### Wide connection range

- Connection range 0.5 – 50 mm<sup>2</sup>  
Solid, fine-stranded and stranded wires can be connected to the terminal blocks of **selos** CLASSICLINE without ferrules, as all block sizes have wire protection.

### Compact design

- **Save space on the rail**  
**selos** CLASSICLINE offers higher density due to the wire size and terminal block pitch:

Connection range	Pitch
2,5 mm <sup>2</sup>	5 mm
4 mm <sup>2</sup>	6 mm
10 mm <sup>2</sup>	8 mm
16 mm <sup>2</sup>	10 mm
25 mm <sup>2</sup>	12 mm
35 mm <sup>2</sup>	16 mm



## Feed-through blocks with screw connection, type 9700 A.. S35

### 9700 A/5 S35

- Feed-through block for mounting on TS 35
- Nominal cross section 2.5 mm<sup>2</sup>



Description	Type	Part No.	Std. Pack
Feed-through block, gray	9700 A/5 S35	54.003.7553.0	100
Feed-through block, (Ex)i, blue	9700 A/5 S35 BLAU	54.003.7553.6	100
<b>General data</b>			
Width / length / height, incl. TS 7.5	5 mm / 47 mm / 38 mm		
Wire strip length	9 mm		
Approvals			
<b>Technical data</b>		<b>IEC</b>	<b>UL</b>
Ratings for use of insulating sleeves	EN 60 947-7-1		
Cross section fine-stranded	0.5 – 2.5 mm <sup>2</sup>		
Cross section solid/stranded	0.5 – 4 mm <sup>2</sup>		
Cross section, AWG		18 – 12	22 – 12
Rated current	24 A	20/30 A	25 A
Rated voltage	800 V	600 V	600 V
Rated impulse voltage	8 kV		
Pollution degree	3		
<b>Accessories</b>		<b>Type</b>	<b>Part No.</b>
End plate, gray		9701/6	07.310.3153.0
Partition, gray		9702/6	07.310.3453.0
Cross connector with screws,	2 pole	9703/5-2	Z7.215.0227.0
E-Cu, uninsulated	3 pole	9703/5-3	Z7.215.0327.0
	4 pole	9703/5-4	Z7.215.0427.0
	5 pole	9703/5-5	Z7.215.0527.0
	6 pole	9703/5-6	Z7.215.0627.0
	Cut-to-order strip 0,6 m long	9703/5-M	Z7.215.0027.0
2-pole switchable jumper			Z7.269.3523.0
Adapter for test plug		9011 D	05.508.8921.0
Cover with warn. symbol for 1 block	yellow		04.325.1656.0

### 9700 A/6 S35

- Feed-through block for mounting on TS 35
- Nominal cross section 4 mm<sup>2</sup>



Description	Type	Part No.	Std. Pack
Feed-through block, gray	9700 A/6 S35	54.004.7553.0	100
Feed-through block, (Ex)i, blue	9700 A/6 S35 BLAU	54.004.7553.6	100
<b>General data</b>			
Width / length / height, incl. TS 7.5	6 mm / 47 mm / 38 mm		
Wire strip length	9 mm		
Approvals			
<b>Technical data</b>		<b>IEC</b>	<b>UL</b>
Ratings for use of insulating sleeves	EN 60 947-7-1		
Cross section fine-stranded	0.5 – 4 mm <sup>2</sup>		
Cross section solid/stranded	0.5 – 6 mm <sup>2</sup>		
Cross section, AWG		18 – 10	22 – 10
Rated current	32 A	30/30 A	35 A
Rated voltage	800 V	600 V	600 V
Rated impulse voltage	8 kV		
Pollution degree	3		
<b>Accessories</b>		<b>Type</b>	<b>Part No.</b>
End plate, gray		9701/6	07.310.3153.0
Partition, gray		9702/6	07.310.3453.0
Cross connector with screws,	2 pole	9703/6-2	Z7.211.0227.0
E-Cu, uninsulated	3 pole	9703/6-3	Z7.211.0327.0
	4 pole	9703/6-4	Z7.211.0427.0
	5 pole	9703/6-5	Z7.211.0527.0
	6 pole	9703/6-6	Z7.211.0627.0
	Cut-to-order strip 0,6 m long	9703/6-M	Z7.211.0027.0
2-pole switchable jumper			Z7.269.2923.0
Adapter for test plug		9011 C	05.508.8821.0
Cover with warn. symbol for 1 block	yellow		04.325.1056.0

## Feed-through blocks with screw connection, type 9700 A.. S35

### 9700 A/8 S35

- Feed-through block for mounting on TS 35
- Nominal cross section 10 mm<sup>2</sup>



Description	Type	Part No.	Std. Pack
Feed-through block, gray	9700 A/8 S 35	54.010.7553.0	100
Feed-through block, (Ex)i, blue	9700 A/8 S 35 BLAU	54.010.7553.6	100
<b>General data</b>			
Width / length / height, incl. TS 7.5	8 mm / 47 mm / 48 mm		
Wire strip length	12 mm		
Approvals			
<b>Technical data</b>	<b>IEC</b>	<b>UL</b>	<b>CSA</b>
	EN 60 947-7-1		
Cross section fine-stranded	1 – 10 mm <sup>2</sup>		
Cross section solid/stranded	1 – 10 mm <sup>2</sup>		
Cross section, AWG		18–8	18–8
Rated current	57 A	50/50 A	55 A
Rated voltage	800 V	600 V	600 V
Rated impulse voltage	8 kV		
Pollution degree	3		
<b>Accessories</b>			
End plate	gray 9701/8	07.310.3253.0	10
Partition	gray 9702/8	07.310.3553.0	10
Cross connector with screws, E-Cu, uninsulated	2 pole 9703/8-2	Z7.212.0227.0	50
	3 pole 9703/8-3	Z7.212.0327.0	50
	4 pole 9703/8-4	Z7.212.0427.0	50
	5 pole 9703/8-5	Z7.212.0527.0	50
	6 pole 9703/8-6	Z7.212.0627.0	50
2-pole switchable jumper		Z7.269.3023.0	50
Adapter for test plug	9011 B	05.508.3221.0	10
Cover with warn. symbol for 1 block	yellow	04.325.1156.0	10
Rapid mounting tool		05.593.5953.0	10

### 9700 A/10 S35

- Feed-through block for mounting on TS 35
- Nominal cross section 16 mm<sup>2</sup>



Description	Type	Part No.	Std. Pack
Feed-through block, gray	9700 A/10 S 35	54.016.7553.0	100
Feed-through block, (Ex)i, blue	9700 A/10 S 35 BLAU	54.016.7553.6	100
<b>General data</b>			
Width / length / height, incl. TS 7.5	10 mm / 49 mm / 51 mm		
Wire strip length	15 mm		
Approvals			
<b>Technical data</b>	<b>IEC</b>	<b>UL</b>	<b>CSA</b>
	EN 60 947-7-1		
Cross section fine-stranded	1.5 – 16 mm <sup>2</sup>		
Cross section solid/stranded	1.5 – 16 mm <sup>2</sup>		
Cross section, AWG		18–6	18–6
Rated current	76 A	65/70 A	70 A
Rated voltage	800 V	600 V	600 V
Rated impulse voltage	8 kV		
Pollution degree	3		
<b>Accessories</b>			
End plate	gray 9701/10	07.310.3953.0	10
Partition	gray 9702/10	07.310.4053.0	10
Cross connector with screws, E-Cu, uninsulated	2 pole 9703/10-2	Z7.214.0227.0	50
	3 pole 9703/10-3	Z7.214.0327.0	50
	4 pole 9703/10-4	Z7.214.0427.0	50
	5 pole 9703/10-5	Z7.214.0527.0	50
	6 pole 9703/10-6	Z7.214.0627.0	50
2-pole switchable jumper		Z7.269.3123.0	50
Adapter for test plug	9011 A	05.508.3121.0	10
Cover with warn. symbol for 1 block	yellow	04.325.1256.0	10

### 9700 A/12 S35

- Feed-through block for mounting on TS 35
- Nominal cross section 25 mm<sup>2</sup>

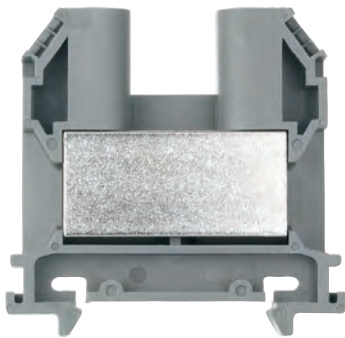

Description	Type	Part No.	Std. Pack	
Feed-through block, gray	9700 A/12 S 35	54.025.7553.0	50	
Feed-through block, (Ex)i, blue	9700 A/12 S 35 BLAU	54.025.7553.6	50	
<b>General data</b>				
Width / length / height, incl. TS 7.5	12 mm / 59 mm / 58 mm			
Wire strip length	20 mm			
Approvals				
<b>Technical data</b>	<b>IEC</b>	<b>UL</b>	<b>CSA</b>	
	EN 60 947-7-1			
Cross section fine-stranded	2.5 – 25 mm <sup>2</sup>			
Cross section solid/stranded	2.5 – 35 mm <sup>2</sup>			
Cross section, AWG		14–4	14–4	
Rated current	101 A	85/100 A	100 A	
Rated voltage	800 V	600 V	600 V	
Rated impulse voltage	8 kV			
Pollution degree	3			
<b>Accessories</b>				
End plate	gray	9701/12	07.310.3353.0	10
Partition	gray	9702/12	07.310.3653.0	10
Cross connector with screws,	2 pole	9703/12-2	Z7.213.0227.0	50
E-Cu, uninsulated	3 pole	9703/12-3	Z7.213.0327.0	50
	4 pole	9703/12-4	Z7.213.0427.0	50
	5 pole	9703/12-5	Z7.213.0527.0	50
	6 pole	9703/12-6	Z7.213.0627.0	50
2-pole switchable jumper			Z7.269.3223.0	50
Adapter for test plug			05.508.6521.0	10
Cover with warn. symbol for 1 block	yellow		04.325.1356.0	10

### 9700 A/16 S35

- Feed-through block for mounting on TS 35
- Nominal cross section 35 mm<sup>2</sup>

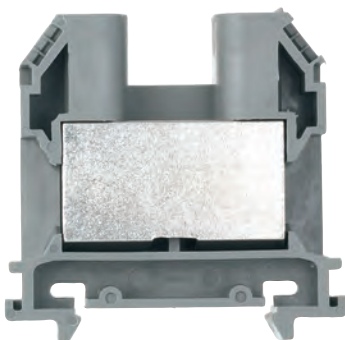

Description	Type	Part No.	Std. Pack	
Feed-through block, gray	9700 A/16 S 35	54.035.7553.0	50	
Feed-through block, (Ex)i, blue	9700 A/16 S 35 BLAU	54.035.7553.6	50	
<b>General data</b>				
Width / length / height, incl. TS 7.5	16 mm / 59 mm / 58 mm			
Wire strip length	20 mm			
Approvals				
<b>Technical data</b>	<b>IEC</b>	<b>UL</b>	<b>CSA</b>	
	EN 60 947-7-1			
Cross section fine-stranded	2,5 – 35 mm <sup>2</sup>			
Cross section solid/stranded	2,5 – 50 mm <sup>2</sup>			
Cross section, AWG		6–2	12–2	
Rated current	125 A	115/130 A	125 A	
Rated voltage	1000 V	600 V	600 V	
Rated impulse voltage	8 kV			
Pollution degree	3			
<b>Accessories</b>				
End plate	gray	9701/12	07.310.3353.0	10
Partition	gray	9702/12	07.310.3653.0	10
Cross connector with screws,	2 pole	9703/16-2	Z7.216.0227.0	50
E-Cu, uninsulated	3 pole	9703/16-3	Z7.216.0327.0	50
	4 pole	9703/16-4	Z7.216.0427.0	50
	5 pole	9703/16-5	Z7.216.0527.0	50
	6 pole	9703/16-6	Z7.216.0627.0	50
2-pole switchable jumper			Z7.269.3423.0	50
Adapter for test plug			05.508.6521.0	10
Cover with warn. symbol for 1 block	yellow		04.325.1456.0	10

## Ground blocks with screw connection, Typ 9700 A.. S35

### 9700 A/6 SL2 S35

- Ground block for mounting on TS 35
- Nominal cross section 4 mm<sup>2</sup>



Description	Type	Part No.	Std. Pack
Ground block, green-yellow	9700 A/6 SL 2 S 35	56.004.9053.0	100
<b>General data</b>			
Width / length / height, incl. TS 7.5	6 mm / 48 mm / 38 mm		
Wire strip length	9 mm		
Approvals			
<b>Technical data</b>	<b>IEC</b>	<b>UL</b>	<b>CSA</b>
	EN 60 947-7-2		
Cross section fine-stranded	0.5 – 4 mm <sup>2</sup>		
Cross section solid/stranded	0.5 – 6 mm <sup>2</sup>		
Cross section, AWG		18–10	22–10
Rated current			
Rated voltage	800 V	600 V	600 V
Rated impulse voltage	8 kV		
Pollution degree	3		
<b>Accessories</b>			
End plate, green	9701/6 SL	07.312.0053.0	10

### 9700 A/8 SL2 S35

- Ground block for mounting on TS 35
- Nominal cross section 10 mm<sup>2</sup>



Description	Type	Part No.	Std. Pack
Ground block, green-yellow	9700 A/8 SL 2 S 35	56.010.9053.0	100
<b>General data</b>			
Width / length / height, incl. TS 7.5	8 mm / 53 mm / 48 mm		
Wire strip length	11 mm		
Approvals			
<b>Technical data</b>	<b>IEC</b>	<b>UL</b>	<b>CSA</b>
	EN 60 947-7-2		
Cross section fine-stranded	0.5 – 10 mm <sup>2</sup>		
Cross section solid/stranded	0.5 – 10 mm <sup>2</sup>		
Cross section, AWG		18–8	18–8
Rated current			
Rated voltage	800 V	600 V	600 V
Rated impulse voltage	8 kV		
Pollution degree	3		
<b>Accessories</b>			
End plate, green	9701/8 SL	07.312.0153.0	10

### 9700 A/10 SL2 S35

- Ground block for mounting on TS 35
- Nominal cross section 16 mm<sup>2</sup>



Description	Type	Part No.	Std. Pack
Ground block, green-yellow	9700 A/10 SL 2 S 35	56.016.9053.0	50
<b>General data</b>			
Width / length / height, incl. TS 7.5	10 mm / 53 mm / 51 mm		
Wire strip length	16 mm		
Approvals			
<b>Technical data</b>	<b>IEC</b>	<b>UL</b>	<b>CSA</b>
	EN 60 947-7-2		
Cross section fine-stranded	1.5 – 16 mm <sup>2</sup>		
Cross section solid/stranded	1.5 – 16 mm <sup>2</sup>		
Cross section, AWG		18–6	16–6
Rated current			
Rated voltage	800 V	600 V	600 V
Rated impulse voltage	8 kV		
Pollution degree	3		
<b>Accessories</b>			
End plate, green	9701/10 SL	07.312.0253.0	10

### 9700 A/16 SL2 S35

- Ground block for mounting on TS 35
- Nominal cross section 35 mm<sup>2</sup>



Description	Type	Part No.	Std. Pack
Ground block, green-yellow	9700 A/16 SL 2 S 35	56.035.9053.0	50
<b>General data</b>			
Width / length / height, incl. TS 7.5	16 mm / 53 mm / 58 mm		
Wire strip length	18 mm		
Approvals			
<b>Technical data</b>	<b>IEC</b>	<b>UL</b>	<b>CSA</b>
	EN 60 947-7-2		
Cross section fine-stranded	2.5 – 35 mm <sup>2</sup>		
Cross section solid/stranded	2.5 – 50 mm <sup>2</sup>		
Cross section, AWG		12–2	12–2
Rated current			
Rated voltage	800 V	600 V	600 V
Rated impulse voltage	8 kV		
Pollution degree	3		
<b>Accessories</b>			
	Type	Part No.	Std. Pack
End plate, green	9701/16 SL	07.312.0353.0	10

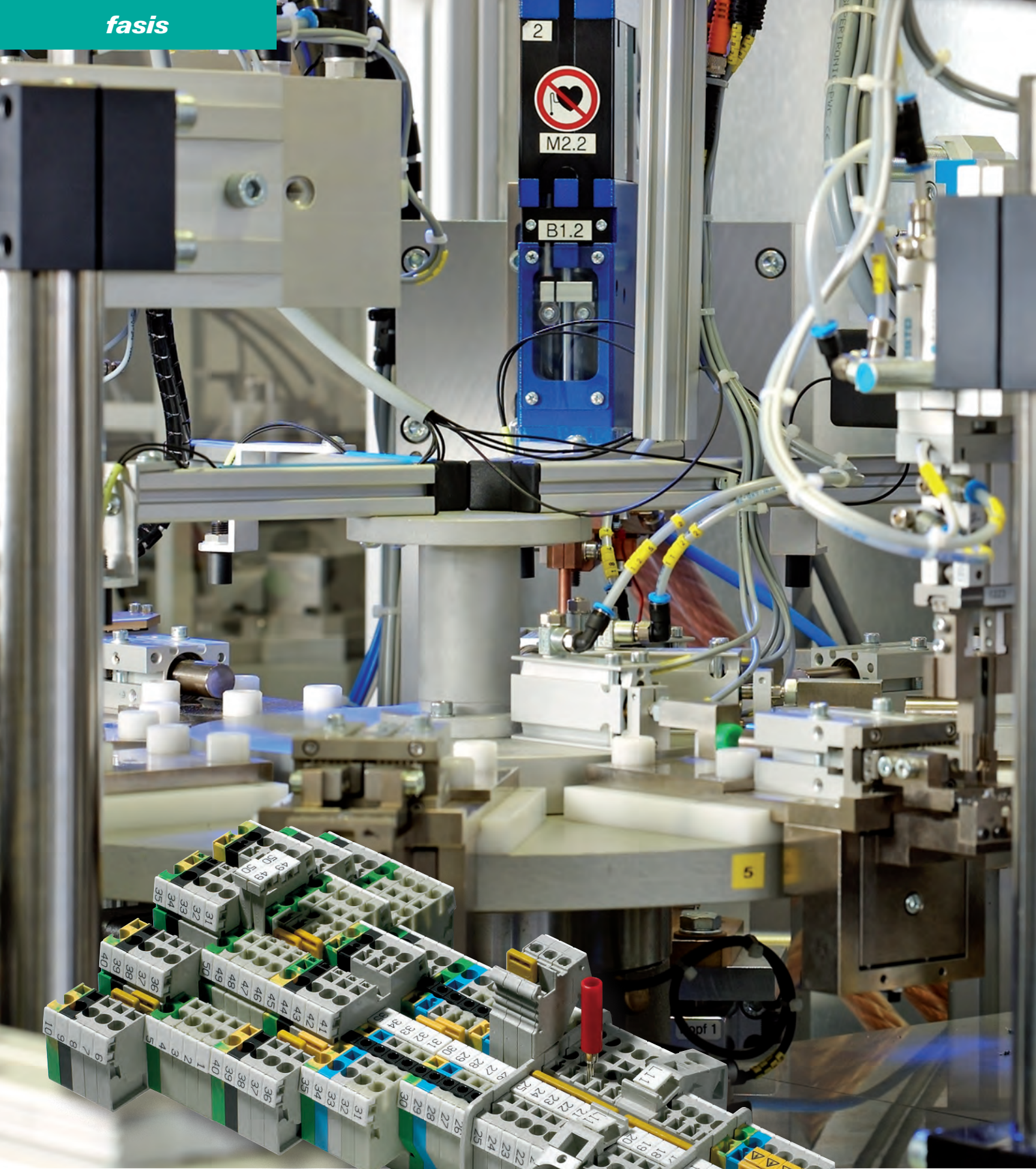

## **fasis** WKFN – DIN Rail Terminal Blocks with **Tension Spring Connection**

The DIN rail terminal block with tension spring technology: **fasis** WKFN is easy to operate, saves time and costs during wiring and reduces inventory costs, and guarantees vibration-proof and maintenance-free connections with high contact forces.

The product line includes feed-through and ground blocks with 2, 3 or 4 termination point as well as multi-tier blocks in two- and three-tier designs, knife-edge disconnect blocks in one- and two-tier designs and fuse blocks. In addition, specialty function blocks are available with application-specific diode circuits.

**fasis** WKFN has been designed for use in machinery and plant construction as well as hazardous locations subject to explosion.

Connection cross-sections up to 35 mm<sup>2</sup>

Rated current of up to 125 A

Rated voltage of up to 1000 V

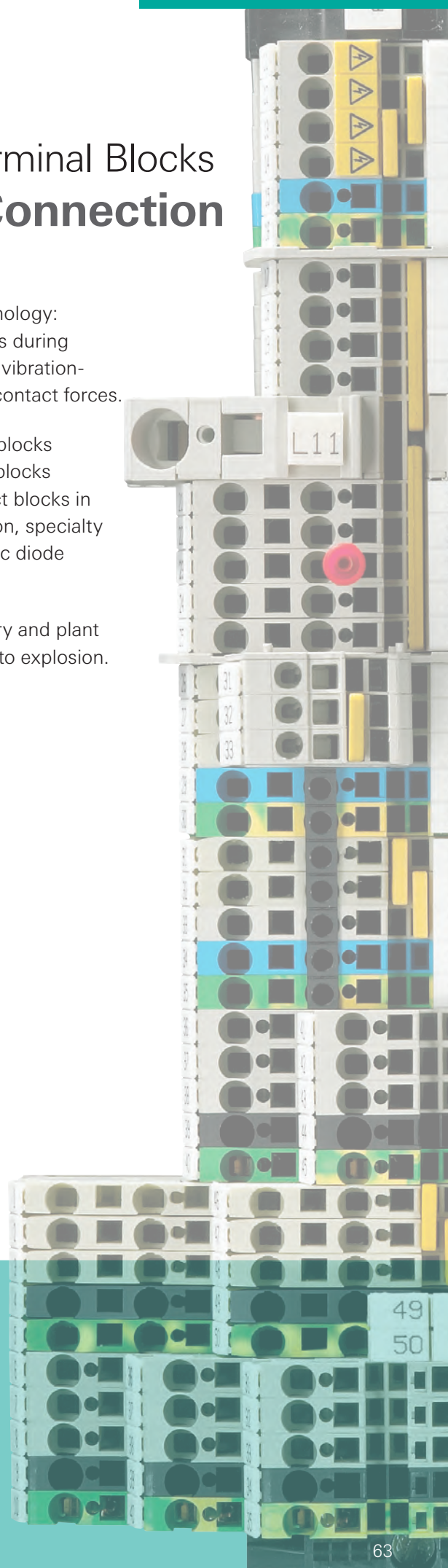
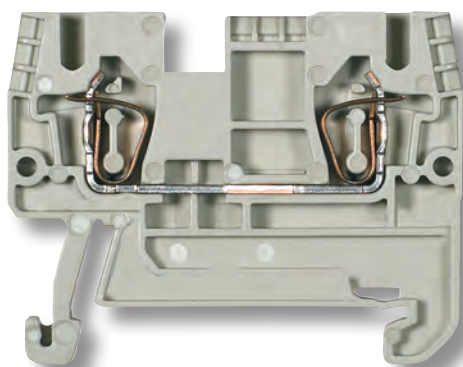

## DIN rail terminal blocks with tension spring connection

### The terminals

- Secure and maintenance-free tension spring connection
- High quality, dynamic contact technology with steel spring and copper current carrying bar
- Easy to wire front connection
- Connection of fine-stranded wires with and without wire ferrules
- Simple operation with a standard screwdriver
- Screwdriver is held securely in the terminal for optimal handling while connecting wires

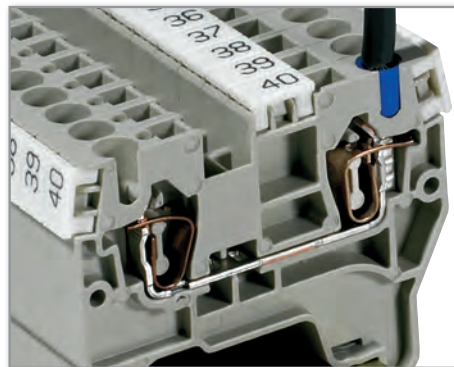

### The system

- Compact design for wiring in confined spaces (to 35 mm<sup>2</sup>)
- Plug-in system provides a Plug & Play solution in the control cabinet – **fasis** CON
- Plug-in jumper bars
- Screwless, snap-on ground terminal
- Function check via modular test adapter through test point in the jumpering channel
- Integrated test jacks in all blocks
- Many labeling options

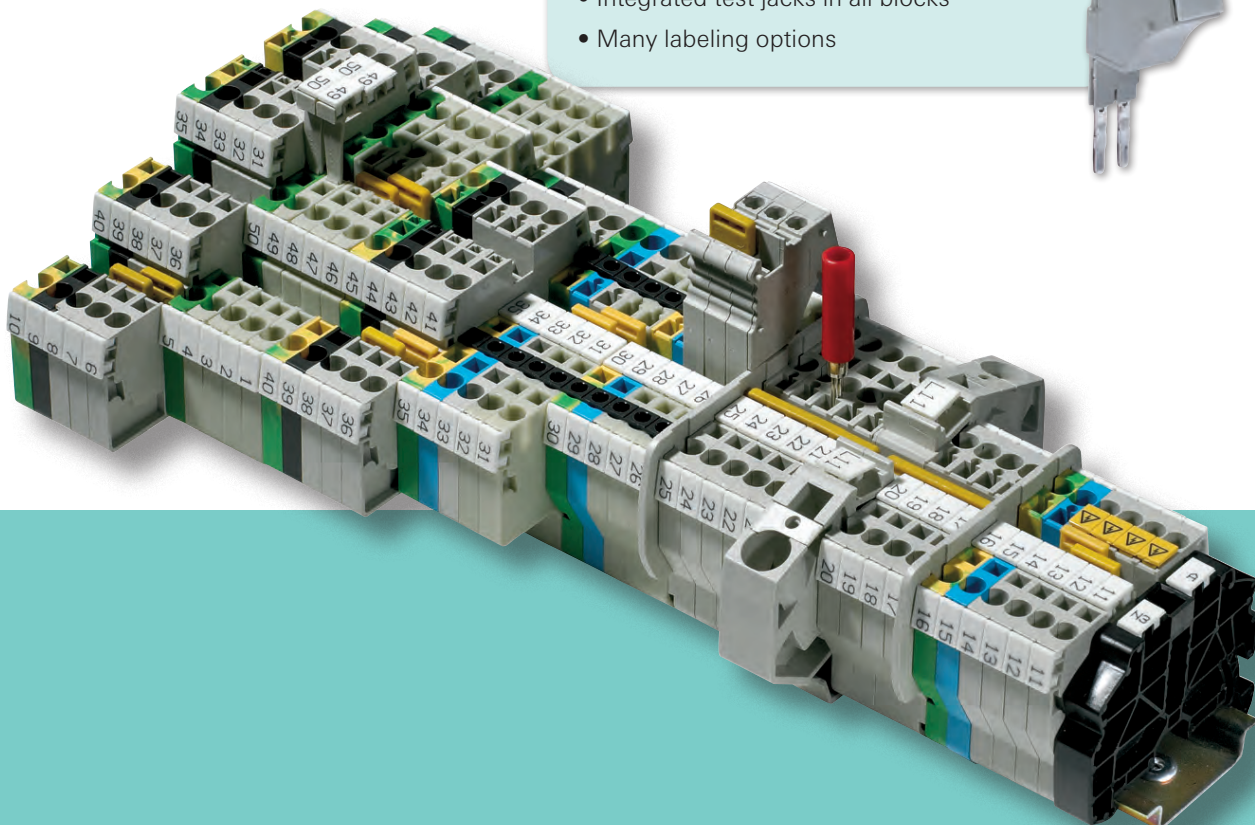
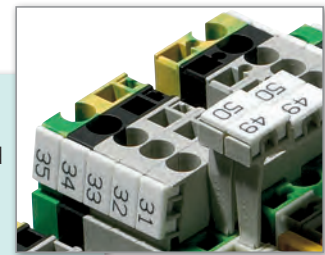



## Wieland jumpering system – Perfect technology

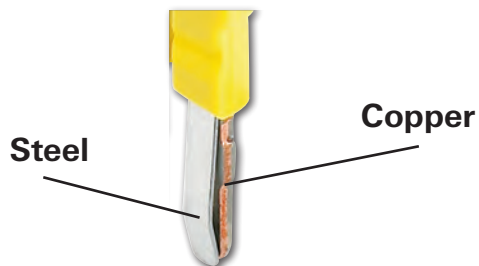
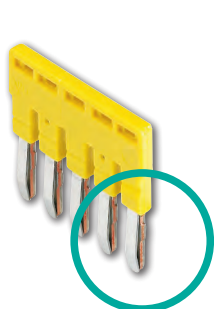

### Perfect technology

- Copper current bar guarantees low contact resistance
- Steel spring guarantees strength, durability, and long-term stability

### Extremely rugged!

- Indestructible steel spring
- Vibration-proof connection



### Simple customization

- Individual poles easy to remove
- Circuits easy to identify

## Wieland marking system – Reliable identification

### Marking strips – Dependable

- Maximum hold to the terminal
- Solidify integrity of the assembly

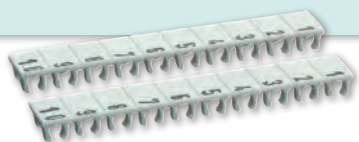

### Marking tags – Individual

- Individual labeling with minimum effort
- Ideal for service and maintenance

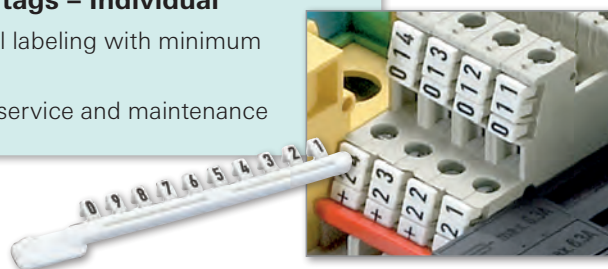

## The accessories



- Wire entry guide strips for secure connection of wires smaller than 1 mm<sup>2</sup>
- Snap-on covers with warning symbols
- Wieland screwdriver for optimal operation of spring tension terminals





## Feed-through blocks with tension spring connection

### WKF 1,5/35

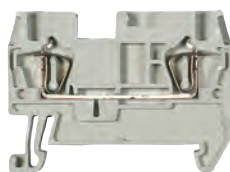
- Feed-through block with tension spring connection for mounting on TS 35
- Nominal cross section 1.5 mm<sup>2</sup>
- Ex e II  II 2GD  
Follow the EX installation instructions on page 149





Description	Type	Part No.	Std. Pack
Feed-through block, gray	WKF 1,5/35	56.702.0053.0	50
Feed-through block, blue	WKF 1,5/35 BLAU	56.702.0053.6	50
<b>General data</b>			
Width / length / height, incl. TS 7.5	4 mm / 49 mm / 37 mm		
Wire strip length	10 mm		
Approvals	ATEX  KEMA 03 ATEX 2056 U		
<b>Technical data</b>	<b>IEC</b>	<b>UL</b>	<b>CSA</b> 
	EN 60 947-7-1		EN 60 079-0/-7
Cross section fine-stranded	0.08–1.5 mm <sup>2</sup>		0.14–1.5 mm <sup>2</sup>
Cross section solid/stranded	0.08–1.5 mm <sup>2</sup>		0.14–1.5 mm <sup>2</sup>
Cross section, AWG	26–14	26–14	
Rated current	17.5 A	15 A	17.5/16.5 A <sup>3)</sup>
Rated voltage	500 V	300 V	300 V
Rated impulse voltage	6 kV		440 V <sup>*)</sup>
Pollution degree	3		
<b>Accessories</b>			
	Type	Part No.	Std. Pack
End plate, gray	APF 1,5	07.312.8153.0	10
Partition, gray	TWF 1,5	07.312.8253.0	10

### WKF 1,5 D1/2/35

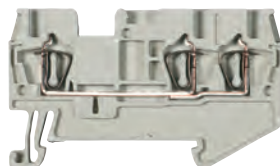
- Duo feed-through block with tension spring connection for mounting on TS 35
- Nominal cross section 1.5 mm<sup>2</sup>
- Ex e II  II 2GD  
Follow the EX installation instructions on page 149





Description	Type	Part No.	Std. Pack
Feed-through block, gray	WKF 1,5 D1/2/35	56.702.5053.0	50
Feed-through block, blue	WKF 1,5 D1/2/35 BLAU	56.702.5053.6	50
<b>General data</b>			
Width / length / height, incl. TS 7.5	4 mm / 60 mm / 37 mm		
Wire strip length	10 mm		
Approvals	ATEX  KEMA 03 ATEX 2056 U		
<b>Technical data</b>	<b>IEC</b>	<b>UL</b>	<b>CSA</b> 
	EN 60 947-7-1		EN 60 079-0/-7
Cross section fine-stranded	0.08–1.5 mm <sup>2</sup>		0.14–1.5 mm <sup>2</sup>
Cross section solid/stranded	0.08–1.5 mm <sup>2</sup>		0.14–1.5 mm <sup>2</sup>
Cross section, AWG	26–14	26–14	
Rated current	17.5 A	15 A	17.5/16.5 A <sup>3)</sup>
Rated voltage	500 V	300 V	300 V
Rated impulse voltage	6 kV		440 V <sup>*)</sup>
Pollution degree	3		
<b>Accessories</b>			
	Type	Part No.	Std. Pack
End plate, gray	APF 1,5 D1/2	07.312.8353.0	10
Segment end plate, gray	SAPF 1,5	07.312.8953.0	10
Partition, gray	TWF 1,5 D1/2	07.312.8453.0	10

### WKF 1,5 D2/2/35

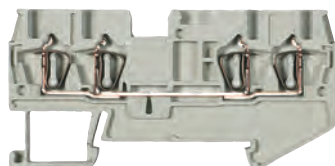
- Duo feed-through block with tension spring connection for mounting on TS 35
- Nominal cross section 1.5 mm<sup>2</sup>
- Ex e II  II 2GD  
Follow the EX installation instructions on page 149



Description	Type	Part No.	Std. Pack
Feed-through block, gray	WKF 1,5 D2/2/35	56.702.5153.0	50
Feed-through block, blue	WKF 1,5 D2/2/35 BLAU	56.702.5153.6	50
<b>General data</b>			
Width / length / height, incl. TS 7.5	4 mm / 72 mm / 37 mm		
Wire strip length	10 mm		
Approvals	ATEX  KEMA 03 ATEX 2056 U		
<b>Technical data</b>	<b>IEC</b>	<b>UL</b>	<b>CSA</b> 
	EN 60 947-7-1		EN 60 079-0/-7
Cross section fine-stranded	0.08–1.5 mm <sup>2</sup>		0.14–1.5 mm <sup>2</sup>
Cross section solid/stranded	0.08–1.5 mm <sup>2</sup>		0.14–1.5 mm <sup>2</sup>
Cross section, AWG	26–14	26–14	
Rated current	17.5 A	15 A	17.5/16.5 A <sup>3)</sup>
Rated voltage	500 V	300 V	300 V
Rated impulse voltage	6 kV		440 V <sup>*)</sup>
Pollution degree	3		
<b>Accessories</b>			
	Type	Part No.	Std. Pack
End plate, gray	APF 1,5 D2/2	07.312.8553.0	10
Segment end plate, gray	SAPF 1,5	07.312.8953.0	10
Partition, gray	TWF 1,5 D2/2	07.312.8653.0	10

## Accessories for *fasis* WKF 1,5...



Accessories		Type	Part No.	Std. Pack
Cross connector, insulated	2 pole	IVB WKF 1,5-2	Z7.268.0227.0	10
	3 pole	IVB WKF 1,5-3	Z7.268.0327.0	10
	4 pole	IVB WKF 1,5-4	Z7.268.0427.0	10
	5 pole	IVB WKF 1,5-5	Z7.268.0527.0	10
	10 pole	IVB WKF 1,5-10	Z7.268.1027.0	10
	20 pole	IVB WKF 1,5-20	Z7.268.2027.0	10
Wire entry guide	0.13-0.2 mm <sup>2</sup>	LEL 1,5/1 WEISS	05.564.4253.0	10
	0.25-0.5 mm <sup>2</sup>	LEL 1,5/2 GRAU	05.564.4353.0	10
Cover with warning symbol over 5 blocks		ADF 1,5/5 GELB	04.343.6953.8	10
Screwdriver, uninsulated		DIN 5264 B 0,4x2,5	06.502.4300.0	5

\*<sup>1</sup> For maintaining the proper isolation distances, the open side of a feed-through terminal block as well as both sides of a jumper are to be covered by partitions.





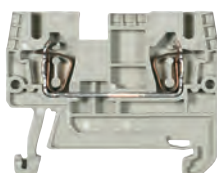

<sup>2</sup> Rated current when using cross connectors

## Feed-through blocks with tension spring connection

### WKFN 2,5/35

- Feed-through block with tension spring connection for mounting on TS 35
- Nominal cross section 2.5 mm<sup>2</sup>
- Ex e I/II  II 2GD IM2  
Follow the EX installation instructions on page 149







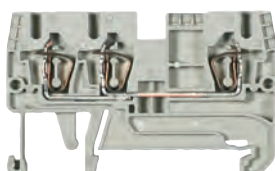

Description	Type	Part No.	Std. Pack
Feed-through block, gray	WKFN 2,5/35	56.703.0055.0	100
Feed-through block, blue	WKFN 2,5/35 BLAU	56.703.0055.6	100
<b>General data</b>			
Width / length / height, incl. TS 7.5	5 mm / 47 mm / 38 mm		
Wire strip length	11 mm		
Approvals	PTB      PTB 04 ATEX 1051 U		
<b>Technical data</b>	<b>IEC</b>	<b>UL</b>	<b>CSA</b> 
	EN 60 947-1-1		EN 60 079-0/-7
Cross section fine-stranded	0.13–2.5 mm <sup>2</sup>		0.2–2.5 mm <sup>2</sup>
Cross section solid/stranded	0.13–4 mm <sup>2</sup>		0.13–4 mm <sup>2</sup>
Cross section, AWG	22–12	24–12	
Rated current	24 A	20 A	24 A
Rated voltage	800 V	600 V	600 V
Rated impulse voltage	8 kV		550 V
Pollution degree	3		
<b>Note</b>	<sup>1)</sup> for 40 K and 45 K		
<b>Accessories</b>			
End plate, gray	Type	Part No.	Std. Pack
End plate, blue	APFN 2,5	07.312.6755.0	10
Partition, gray	APFN 2,5 BLAU	07.312.6755.6	10
	TWFN 2,5	07.312.6855.0	10

### WKFN 2,5 D1/2/35

- Duo feed-through block with tension spring connection for mounting on TS 35
- Nominal cross section 2.5 mm<sup>2</sup>
- Ex e I/II  II 2GD IM2  
Follow the EX installation instructions on page 149









Description	Type	Part No.	Std. Pack
Feed-through block, gray	WKFN 2,5 D1/2/35	56.703.5055.0	100
Feed-through block, blue	WKFN 2,5 D1/2/35 BLAU	56.703.5055.6	100
<b>General data</b>			
Width / length / height, incl. TS 7.5	5 mm / 60 mm / 38 mm		
Wire strip length	11 mm		
Approvals	PTB      PTB 04 ATEX 1051 U		
<b>Technical data</b>	<b>IEC</b>	<b>UL</b>	<b>CSA</b> 
	EN 60 947-1-1		EN 60 079-0/-7
Cross section fine-stranded	0.13–2.5 mm <sup>2</sup>		0.2–2.5 mm <sup>2</sup>
Cross section solid/stranded	0.13–4 mm <sup>2</sup>		0.13–4 mm <sup>2</sup>
Cross section, AWG	22–12	24–12	
Rated current	24 A	20 A	24 A
Rated voltage	800 V	600 V	600 V
Rated impulse voltage	8 kV		550 V
Pollution degree	3		
<b>Note</b>	<sup>1)</sup> for 40 K and 45 K		
<b>Accessories</b>			
End plate, gray	Type	Part No.	Std. Pack
End plate, blue	APFN 2,5 D1/2	07.312.6955.0	10
Partition, gray	APFN 2,5 D1/2 BLAU	07.312.6955.6	10
	TWFN 2,5 D1/2	07.312.7055.0	10

### WKFN 2,5 D2/2/35

- Duo feed-through block with tension spring connection for mounting on TS 35
- Nominal cross section 2.5 mm<sup>2</sup>
- Ex e I/II  II 2GD IM2  
Follow the EX installation instructions on page 149



Description	Type	Part No.	Std. Pack
Feed-through block, gray	WKFN 2,5 D2/2/35	56.703.5155.0	100
Feed-through block, blue	WKFN 2,5 D2/2/35 BLAU	56.703.5155.6	100
<b>General data</b>			
Width / length / height, incl. TS 7.5	5 mm / 72 mm / 38 mm		
Wire strip length	11 mm		
Approvals	PTB      PTB 04 ATEX 1051 U		
<b>Technical data</b>	<b>IEC</b>	<b>UL</b>	<b>CSA</b> 
	EN 60 947-1-1		EN 60 079-0/-7
Cross section fine-stranded	0.13–2.5 mm <sup>2</sup>		0.2–2.5 mm <sup>2</sup>
Cross section solid/stranded	0.13–4 mm <sup>2</sup>		0.13–4 mm <sup>2</sup>
Cross section, AWG	22–12	24–12	
Rated current	24 A	20 A	24 A
Rated voltage	800 V	600 V	600 V
Rated impulse voltage	8 kV		550 V
Pollution degree	3		
<b>Note</b>	<sup>1)</sup> for 40 K and 45 K		
<b>Accessories</b>			
End plate, gray	Type	Part No.	Std. Pack
End plate, blue	APFN 2,5 D2/2	07.312.7155.0	10
Partition, gray	APFN 2,5 D2/2 BLAU	07.312.7155.6	10
	TWFN 2,5 D2/2	07.312.7255.0	10

# Supply block

## WKF 16/35 PV/WKFN

- Supply block for mounting on TS 35
- Nominal cross section 16 mm<sup>2</sup>
- Ex e I/II Ⓜ II 2GD IM2  
Follow the EX installation instructions on page 149

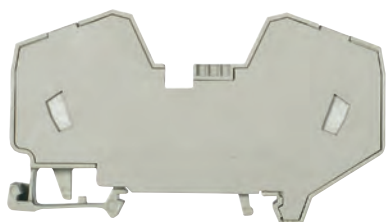

Description	Type	Part No.	Std. Pack			
Power feed-in block, gray	WKF 16/35 PV/WKFN	56.716.0353.0	20			
<b>General data</b>						
Width / length / height, incl. TS 7.5	12 mm / 82 mm / 48 mm					
Wire strip length	15 mm					
Approvals	IEC ATEX KEMA 01 ATEX 2087 U					
<b>Technical data</b>		<b>IEC</b>	<b>UL</b>	<b>CSA</b>	<b>Ⓜ</b>	
	EN 60 947-7-1				EN 60 079-0/-7	
Cross section fine-stranded	4–16 mm <sup>2</sup>				4–16 mm <sup>2</sup>	
Cross section solid/stranded	4–16 mm <sup>2</sup>				4–16 mm <sup>2</sup>	
Cross section, AWG		24–4	12–4			
Rated current	76 A	75 A	78 A		64 A*)	
Rated voltage	800 V	600 V	600 V		690 V	
Rated impulse voltage	8 kV					
Pollution degree	3					
<b>Note</b>	* Type-specific output currents upon request					
<b>Accessories</b>				Type	Part No.	Std. Pack
Cover with warning symbol over 4 blocks	ADF 16/4 GELB	04.343.6653.8	10			
Screwdriver, uninsulated	DIN 5264 B 1,0x5,5	06.502.4200.0	5			

- Potential distribution with standard cross connector IVB WKF 2.5...
- Parallel connection of two cross connectors → double jumpering
- Potential distributions are possible on one or both sides

Potential-distribution	one side		both sides	
	single	double	single	double
$I_{max}$	48	68	72	76

$$I_{max} = \sum I_n \leq \sum I_{N \text{ block}}$$

## Accessories for fasis WKFN 2,5...







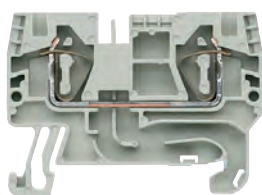

Accessories	Type	Part No.	Std. Pack	
Cross connector, insulated	2 pole	IVB WKF 2,5–2	Z7.280.6227.0	10
	3 pole	IVB WKF 2,5–3	Z7.280.6327.0	10
	4 pole	IVB WKF 2,5–4	Z7.280.6427.0	10
	5 pole	IVB WKF 2,5–5	Z7.280.6527.0	10
	6 pole	IVB WKF 2,5–6	Z7.280.6627.0	10
	7 pole	IVB WKF 2,5–7	Z7.280.6727.0	20
	8 pole	IVB WKF 2,5–8	Z7.280.6827.0	20
	9 pole	IVB WKF 2,5–9	Z7.280.6927.0	20
	10 pole	IVB WKF 2,5–10	Z7.280.7027.0	20
	20 pole	IVB WKF 2,5–20	Z7.280.8027.0	20
Wire entry guide	0.13–0.2 mm <sup>2</sup>	LELN 2,5/1 WEISS	05.564.3755.0	100
	0.25–0.5 mm <sup>2</sup>	LELN 2,5/2 GRAU	05.564.3855.0	100
	0.75–1.0 mm <sup>2</sup>	LELN 2,5/3 SCHWARZ	05.564.3955.0	100
Cover with warning symbol over 4 blocks	yellow	ADFN 2,5/4 GELB	04.343.8353.8	10
Test adapter, modular		PS WKC/F	Z1.299.9753.0	10
Test plug		ST 2/2,3	Z5.553.2921.0	10
Screwdriver, uninsulated		DIN 5264 B 0,6x3,5	06.502.4000.0	5
Screwdriver, uninsulated, MINI		DIN 5264 B 0,6x3,5 M	06.502.5000.0	10

## Feed-through blocks with tension spring connection

### WKFN 4/35

- Feed-through block with tension spring connection for mounting on TS 35
- Nominal cross section 4 mm<sup>2</sup>
- Ex e I/II  II 2GD IM2  
Follow the EX installation instructions on page 149







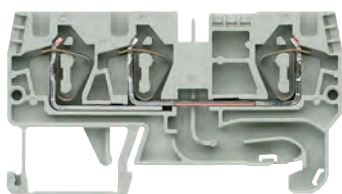

Description	Type	Part No.	Std. Pack
Feed-through block, gray	WKFN 4/35	56.704.0055.0	100
Feed-through block, blue	WKFN 4/35 BLAU	56.704.0055.6	100
<b>General data</b>			
Width / length / height, incl. TS 7.5	6 mm / 51 mm / 38 mm		
Wire strip length	11 mm		
Approvals	PTB      PTB 05 ATEX 1104 U		
<b>Technical data</b>	<b>IEC</b>	<b>UL</b>	<b>CSA</b> 
	EN 60 947-7-1		EN 60 079-0/-7
Cross section fine-stranded	0.13–4 mm <sup>2</sup>		0.13–4 mm <sup>2</sup>
Cross section solid/stranded	0.13–6 mm <sup>2</sup>		0.2–6 mm <sup>2</sup>
Cross section, AWG		24–10	24–10
Rated current	32 A	30 A	32 A
Rated voltage	800 V	600 V	600 V
Rated impulse voltage	8 kV		690 V
Pollution degree	3		
<b>Note</b>			<sup>1)</sup> 1. value at 40 K/ 2. value at 45 K
<b>Accessories</b>			
End plate, gray	APFN 4	07.312.9255.0	10
End plate, blue	APFN 4 BLAU	07.312.9255.6	10
Partition, gray	TWFN 4	07.312.9355.0	10

### WKFN 4 D1/2/35

- Duo feed-through block with tension spring connection for mounting on TS 35
- Nominal cross section 4 mm<sup>2</sup>
- Ex e I/II  II 2GD IM2  
Follow the EX installation instructions on page 149







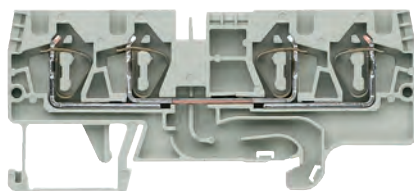

Description	Type	Part No.	Std. Pack
Feed-through block, gray	WKFN 4 D1/2/35	56.704.5055.0	100
Feed-through block, blue	WKFN 4 D1/2/35 BLAU	56.704.5055.6	100
<b>General data</b>			
Width / length / height, incl. TS 7.5	6 mm / 67 mm / 38 mm		
Wire strip length	11 mm		
Approvals	PTB      PTB 05 ATEX 1104 U		
<b>Technical data</b>	<b>IEC</b>	<b>UL</b>	<b>CSA</b> 
	EN 60 947-7-1		EN 60 079-0/-7
Cross section fine-stranded	0.13–4 mm <sup>2</sup>		0.13–4 mm <sup>2</sup>
Cross section solid/stranded	0.13–6 mm <sup>2</sup>		0.2–6 mm <sup>2</sup>
Cross section, AWG		24–10	24–10
Rated current	32 A	30 A	32 A
Rated voltage	800 V	600 V	600 V
Rated impulse voltage	8 kV		550 V
Pollution degree	3		
<b>Note</b>			<sup>1)</sup> 1. value at 40 K/ 2. value at 45 K
<b>Accessories</b>			
End plate, gray	APFN 4 D1/2	07.312.9455.0	10
End plate, blue	APFN 4 D1/2 BLAU	07.312.9455.6	10
Partition, gray	TWFN 4 D1/2	07.312.9555.0	10

### WKFN 4 D2/2/35

- Duo feed-through block with tension spring connection for mounting on TS 35
- Nominal cross section 4 mm<sup>2</sup>
- Ex e I/II  II 2GD IM2  
Follow the EX installation instructions on page 149



Description	Type	Part No.	Std. Pack
Feed-through block, gray	WKFN 4 D2/2/35	56.704.5155.0	100
Feed-through block, blue	WKFN 4 D2/2/35 BLAU	56.704.5155.6	100
<b>General data</b>			
Width / length / height, incl. TS 7.5	6 mm / 82 mm / 38 mm		
Wire strip length	11 mm		
Approvals	PTB      PTB 05 ATEX 1104 U		
<b>Technical data</b>	<b>IEC</b>	<b>UL</b>	<b>CSA</b> 
	EN 60 947-7-1		EN 60 079-0/-7
Cross section fine-stranded	0.13–4 mm <sup>2</sup>		0.13–4 mm <sup>2</sup>
Cross section solid/stranded	0.13–6 mm <sup>2</sup>		0.2–6 mm <sup>2</sup>
Cross section, AWG		24–10	24–10
Rated current	32 A	30 A	32 A
Rated voltage	800 V	600 V	600 V
Rated impulse voltage	8 kV		550 V
Pollution degree	3		
<b>Note</b>			<sup>1)</sup> 1. value at 40 K/ 2. value at 45 K
<b>Accessories</b>			
End plate, gray	APFN 4 D2/2	07.312.9055.0	10
End plate, blue	APFN 4 D2/2 BLAU	07.312.9055.6	10
Partition, gray	TWFN 4 D2/2	07.312.9155.0	10

### WKF 16/35 PV/WKFN

- Supply block for mounting on TS 35
- Nominal cross section 16 mm<sup>2</sup>
- Ex e I/II Ⓜ II 2GD IM2  
Follow the EX installation instructions on page 149

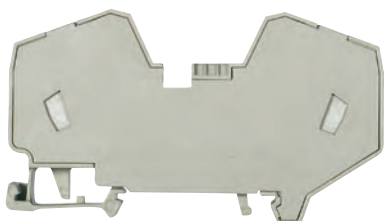

Description	Type	Part No.	Std. Pack			
Power feed-in block, gray	WKF 16/35 PV/WKFN	56.716.0353.0	20			
<b>General data</b>						
Width / length / height, incl. TS 7.5	12 mm / 82 mm / 48 mm					
Wire strip length	15 mm					
Approvals	IEC ATEX KEMA 01 ATEX 2087 U					
<b>Technical data</b>		<b>IEC</b>	<b>UL</b>	<b>CSA</b>	<b>Ⓜ</b>	
	EN 60 947-7-1				EN 60 079-0/-7	
Cross section fine-stranded	4–16 mm <sup>2</sup>				4–16 mm <sup>2</sup>	
Cross section solid/stranded	4–16 mm <sup>2</sup>				4–16 mm <sup>2</sup>	
Cross section, AWG		24–4	12–4			
Rated current	76 A	75 A	78 A		64 A*	
Rated voltage	800 V	600 V	600 V		690 V	
Rated impulse voltage	8 kV					
Pollution degree	3					
<b>Note</b>	* Type-specific output currents upon request					
<b>Accessories</b>				Type	Part No.	Std. Pack
Cover with warning symbol over 4 blocks	ADF 16/4 GELB	04.343.6653.8	10			
Screwdriver, uninsulated	DIN 5264 B 1,0x5,5	06.502.4200.0	5			

- Potential distribution with standard cross connector IVB WKF 4...
- Parallel connection of two cross connectors → double jumpering
- Potential distributions are possible on one or both sides

Potential distribution	one side		both sides	
	single	double	single	double
$I_{max}$	64	76	76	76

$$I_{max} = \sum I_n \leq \sum I_{N \text{ block}}$$

## Accessories for fasis WKFN 4...



Accessories	Type	Part No.	Std. Pack
Cross connector, insulated	2 pole	VB WKF 4–2	Z7.261.1227.0
	3 pole	IVB WKF 4–3	Z7.261.1327.0
	4 pole	IVB WKF 4–4	Z7.261.1427.0
	5 pole	IVB WKF 4–5	Z7.261.1527.0
	6 pole	IVB WKF 4–6	Z7.261.1627.0
	7 pole	IVB WKF 4–7	Z7.261.1727.0
	8 pole	IVB WKF 4–8	Z7.261.1827.0
	9 pole	IVB WKF 4–9	Z7.261.1927.0
	10 pole	IVB WKF 4–10	Z7.261.2027.0
	Wire entry guide	0.13–0.2 mm <sup>2</sup>	LEL 4/1 WEISS
0.25–0.5 mm <sup>2</sup>		LEL 4/2 GRAU	05.561.8653.0
0.75–1.0 mm <sup>2</sup>		LEL 4/3 SCHWARZ	05.561.8753.0
Cover with warning symbol over 4 blocks	yellow	ADF 4/4 GELB	04.343.6153.8
Test adapter, modular		PS WKC/F	Z1.299.9753.0
Test plug		ST 2/2,3	Z5.553.2921.0
Screwdriver, uninsulated		DIN 5264 B 0,6x3,5	06.502.4000.0
Screwdriver, uninsulated, MINI		DIN 5264 B 0,6x3,5 M	06.502.5000.0

## Feed-through blocks with tension spring connection

Description	Type	Part No.	Std. Pack
Feed-through block, blue	WKFN 6/35 BLAU	56.706.0055.6	100

General data				
Width / length / height, incl. TS 7.5	8 mm / 66 mm / 45 mm			
Wire strip length	12 mm			
Approvals	PTB 06 ATEX 1075 U			
Technical data	IEC	UL	CSA	Ex
	EN 60 947-7-1			EN 60 079-0/-7
Cross section fine-stranded	0.2–6 mm <sup>2</sup>			0.2–6 mm <sup>2</sup>
Cross section solid/stranded	1.5–10 mm <sup>2</sup>			1.5–10 mm <sup>2</sup>
Cross section, AWG		24–8	24–8	
Rated current	41 A	50 A	41 A	39/41 A*
Rated voltage	800 V	600 V	600 V	550 V
Rated impulse voltage	8 kV			
Pollution degree	3			
<b>Note</b>				* 1. value at 40K/ 2. value at 45K

Accessories	Type	Part No.	Std. Pack
End plate, gray	APFN 6	07.313.0455.0	10
End plate, blue	APFN 6 BLAU	07.313.0455.6	10
Partition, gray	TWFN 6	07.313.0555.0	10

### WKFN 6/35

- Feed-through block with tension spring connection for mounting on TS 35
- Nominal cross section 6 mm<sup>2</sup>
- Ex e I/II Ex II 2GD IM2  
Follow the EX installation instructions on page 149

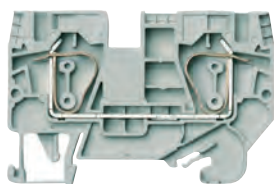

Description	Type	Part No.	Std. Pack
Feed-through block, blue	WKFN 6 D1/2/35 BLAU	56.706.5055.6	100

General data				
Width / length / height, incl. TS 7.5	8 mm / 90 mm / 45 mm			
Wire strip length	12 mm			
Approvals	PTB 06 ATEX 1075 U			
Technical data	IEC	UL	CSA	Ex
	EN 60 947-7-1			EN 60 079-0/-7
Cross section fine-stranded	0.2–6 mm <sup>2</sup>			0.2–6 mm <sup>2</sup>
Cross section solid/stranded	1.5–10 mm <sup>2</sup>			1.5–10 mm <sup>2</sup>
Cross section, AWG		24–8	24–8	
Rated current	41 A	50 A	41 A	39/41 A*
Rated voltage	800 V	600 V	600 V	550 V
Rated impulse voltage	8 kV			
Pollution degree	3			
<b>Note</b>				* 1. value at 40K/ 2. value at 45K

Accessories	Type	Part No.	Std. Pack
End plate, gray	APFN 6 D1/2	07.313.0655.0	10
End plate, blue	APFN 6 D1/2 BLAU	07.313.0655.6	10
Partition, gray	TWFN 6 D1/2	07.313.0755.0	10

### WKFN 6 D1/2/35

- Duo-feed-through block with tension spring connection for mounting on TS 35
- Nominal cross section 6 mm<sup>2</sup>
- Ex e I/II Ex II 2GD IM2  
Follow the EX installation instructions on page 149

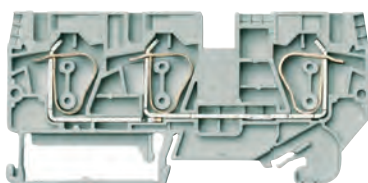

## Accessories for fasis WKFN 6...

Accessories	Type	Part No.	Std. Pack	
Cross connector, insulated**	2 pole	IVB WKFN 6–2	Z7.282.5227.0	10
	3 pole	IVB WKFN 6–3	Z7.282.5327.0	10
	4 pole	IVB WKFN 6–4	Z7.282.5427.0	10
	5 pole	IVB WKFN 6–5	Z7.282.5527.0	10
	Cover with warning symbol over 4 blocks	yellow	ADF 6/4 GELB	04.343.6253.8
Test plug		ST 2/2,3	Z5.553.2921.0	10
Screwdriver, uninsulated		DIN 5264 B 0,8x4	06.502.4100.0	5

  

\*\* When cross connectors are used according to EN 60079-0 and EN 60079-7, the current must be reduced to max. 3.5 A.







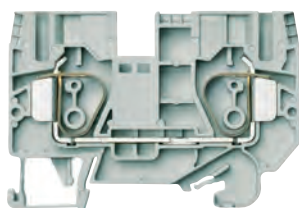

### WKFN 10/35

- Feed-through block with tension spring connection for mounting on TS 35
- Nominal cross section 10 mm<sup>2</sup>
- Ex e I/II  II 2GD IM2  
Follow the EX installation instructions on page 149

<sup>3)</sup> Pls. note that the current must be reduced for EX applications.



Description	Type	Part No.	Std. Pack
Feed-through block, gray	WKFN 10/35	56.710.0055.0	50
Feed-through block, blue	WKFN 10/35 BLAU	56.710.0055.6	50

General data			
Width / length / height, incl. TS 7.5	10 mm / 72 mm / 50 mm		
Wire strip length	15 mm		
Approvals	PTB    PTB 06 ATEX 1075 U		
Technical data	IEC	UL	CSA
	EN 60 947-7-1		EN 60 079-0/-7
Cross section fine-stranded	0.2–10 mm <sup>2</sup>		0.2–10 mm <sup>2</sup>
Cross section solid/stranded	1.5–16 mm <sup>2</sup>		1.5–16 mm <sup>2</sup>
Cross section, AWG		16–6	16–6
Rated current	57 A	60 A	65 A
Rated voltage	800 V	600 V	600 V
Rated impulse voltage	8 kV		550 V
Pollution degree	3		
<b>Note</b>			* 1. value at 40K/ 2. value at 45K

Accessories	Type	Part No.	Std. Pack
End plate, gray	APFN 10	07.313.0855.0	10
End plate, blue	APFN 10 BLAU	07.313.0855.6	10
Partition, gray	TWFN 10	07.313.0955.0	10



### WKFN 10 D1/2/35

- Duo-feed-through block with tension spring connection for mounting on TS 35
- Nominal cross section 10 mm<sup>2</sup>
- Ex e I/II  II 2GD IM2  
Follow the EX installation instructions on page 149

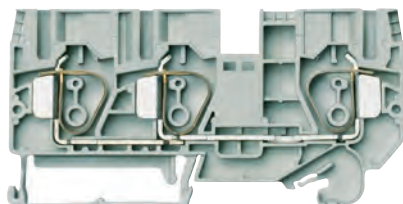
<sup>3)</sup> Pls. note that the current must be reduced for EX applications.



Description	Type	Part No.	Std. Pack
Feed-through block, gray	WKFN 10 D1/2/35	56.710.5055.0	50
Feed-through block, blue	WKFN 10 D1/2/35 BLAU	56.710.5055.6	50

General data			
Width / length / height, incl. TS 7.5	10 mm / 98 mm / 50 mm		
Wire strip length	15 mm		
Approvals	PTB    PTB 06 ATEX 1075 U		
Technical data	IEC	UL	CSA
	EN 60 947-7-1		EN 60 079-0/-7
Cross section fine-stranded	0.2–10 mm <sup>2</sup>		0.2–10 mm <sup>2</sup>
Cross section solid/stranded	1.5–16 mm <sup>2</sup>		1.5–16 mm <sup>2</sup>
Cross section, AWG		16–6	16–6
Rated current	57 A	60 A	65 A
Rated voltage	1000 V	600 V	600 V
Rated impulse voltage	8 kV		550 V
Pollution degree	3		
<b>Note</b>			* 1. value at 40K/ 2. value at 45K

Accessories	Type	Part No.	Std. Pack
End plate, gray	APFN 10 D1/2	07.313.1055.0	10
End plate, blue	APFN 10 D1/2 BLAU	07.313.1055.6	10
Partition, gray	TWFN 10 D1/2	07.313.1155.0	10

## Accessories for *fasis* WKFN 10...



Accessories	Type	Part No.	Std. Pack
Cross connector, insulated**	2 pole	IVB WKFN 10–2	Z7.283.8227.0
Reducing jumper, WKF 35 to WKFN 10 <sup>3)</sup>		IVB WKFN 35R10	Z7.285.6427.0
Cover with warning symbol over 4 blocks	yellow	ADF 10/4 GELB	04.343.6453.8
Test plug		ST 2/2,3	Z5.553.2921.0
Screwdriver, uninsulated		DIN 5264 B 1x5,5	06.502.4200.0





\*\* When cross connectors are used acc. to EN 60079-0 and EN 60079-7 the current must be reduced to 4 A/40 K or 5 A/45 K for type WKFN 10/35.

## Feed-through blocks with tension spring connection

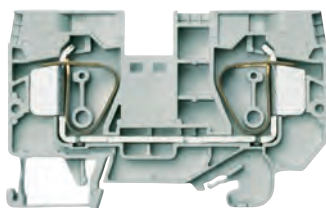
### WKFN 16/35

- Feed-through block with tension spring connection for mounting on TS 35
- Nominal cross section 16 mm<sup>2</sup>
- Ex e I/II  II 2GD IM2  
Follow the EX installation instructions on page 149





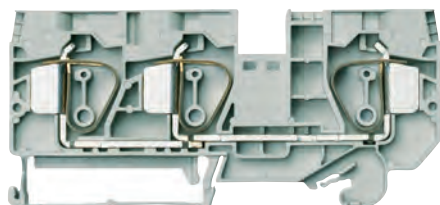

Description	Type	Part No.	Std. Pack
Feed-through block, gray	WKFN 16/35	56.716.0055.0	50
Feed-through block, blue	WKFN 16/35 BLAU	56.716.0055.6	100
<b>General data</b>			
Width / length / height, incl. TS 7.5	12 mm / 79 mm / 50 mm		
Wire strip length	16 mm		
Approvals	PTB    PTB 06 ATEX 1075 U		
<b>Technical data</b>	<b>IEC</b>	<b>UL</b>	<b>CSA</b> 
	EN 60 947-7-1		EN 60 079-0/-7
Cross section fine-stranded	0.2–16 mm <sup>2</sup>		
Cross section solid/stranded	1.5–25 mm <sup>2</sup>		
Cross section, AWG	16–4	16–4	
Rated current	76 A	85 A	74/76 A*
Rated voltage	1000 V	600 V	550 V
Rated impulse voltage	8 kV		
Pollution degree	3		
<b>Note</b>	* 1. value at 40K/ 2. value at 45K		
<b>Accessories</b>			
End plate, gray	APFN 16	07.313.1255.0	10
End plate, blue	APFN 16 BLAU	07.313.1255.6	10
Partition, gray	TWFN 16	07.313.1355.0	10
Cross connector, insulated** 2 pole	IVB WKF 16–2	Z7.284.4227.0	10
Cover with warning symbol for 4 blocks	ADF 16/4 GELB	04.343.6653.8	10

### WKFN 16 D1/2/35

- Duo-feed-through block with tension spring connection for mounting on TS 35
- Nominal cross section 16 mm<sup>2</sup>
- Ex e I/II  II 2GD IM2  
Follow the EX installation instructions on page 149





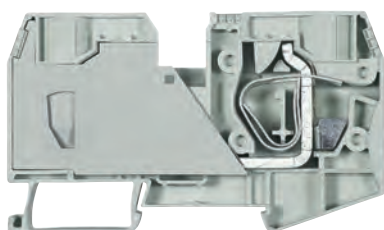

Description	Type	Part No.	Std. Pack
Feed-through block, gray	WKFN 16 D1/2/35	56.716.5055.0	50
Feed-through block, blue	WKFN 16 D1/2/35 BLAU	56.716.5055.6	100
<b>General data</b>			
Width / length / height, incl. TS 7.5	12 mm / 107 mm / 50 mm		
Wire strip length	16 mm		
Approvals	PTB    PTB 06 ATEX 1075 U		
<b>Technical data</b>	<b>IEC</b>	<b>UL</b>	<b>CSA</b> 
	EN 60 947-7-1		EN 60 079-0/-7
Cross section fine-stranded	0.2–16 mm <sup>2</sup>		
Cross section solid/stranded	1.5–25 mm <sup>2</sup>		
Cross section, AWG	16–4	16–4	
Rated current	76 A	85 A	74/76 A*
Rated voltage	1000 V	600 V	550 V
Rated impulse voltage	8 kV		
Pollution degree	3		
<b>Note</b>	* 1. value at 40K/ 2. value at 45K		
<b>Accessories</b>			
End plate, gray	APFN 16 D1/2	07.313.1455.0	10
End plate, blue	APFN 16 D1/2 BLAU	07.313.1455.6	10
Partition, gray	TWFN 16 D1/2	07.313.1555.0	10
Cross connector, insulated** 2 pole	IVB WKF 16–2	Z7.284.4227.0	10
Cover with warning symbol for 4 blocks	ADF 16/4 GELB	04.343.6653.8	10

### WKF 35/35

- Feed-through block with tension spring connection for mounting on TS 35
- Nominal cross section 35 mm<sup>2</sup>
- Ex e II  II 2GD  
Follow the EX installation instructions on page 149



Description	Type	Part No.	Std. Pack
Feed-through block, gray	WKF 35/35	56.735.0053.0	10
Feed-through block, blue	WKF 35/35 BLAU	56.735.0053.6	10
<b>General data</b>			
Width / length / height, incl. TS 7.5	16 mm / 100 mm / 59 mm		
Wire strip length	18 mm		
Approvals	ATEX    KEMA 03 ATEX 2057 U		
<b>Technical data</b>	<b>IEC</b>	<b>UL</b>	<b>CSA</b> 
	EN 60 947-7-1		EN 60 079-0/-7
Cross section fine-stranded	2.5–35 mm <sup>2</sup>		
Cross section solid/stranded	2.5–35 mm <sup>2</sup>		
Cross section, AWG	12–2	12–2	
Rated current	125 A	115 A	92/108 A <sup>1)</sup>
Rated voltage	800 V	600 V	690 V
Rated impulse voltage	8 kV		
Pollution degree	3		
<b>Note</b>	<sup>1)</sup> with/without jumper		
<b>Accessories</b>			
Cross connector, insulated 2 pole	IVB WKF 35-2	Z7.285.6227.0	10

## Potential supply with feed-through blocks up to 35 mm<sup>2</sup>

$I_{\max E}$ :  $I_{\max}$ . supply  
 $I_{\max R}$ :  $I_{\text{reducing cross connector}}$   
 $I_{N-A}$ :  $I_N$  output terminal blocks

Potential distribution	Distribution on one side		Distribution on both sides	
	2 poles	several poles	2 poles	several poles
35-R-10 $I_{\max}$ . supply	125 A	125 A	125 A	125 A
$I_{\text{reducing cross connector}}$	57 A	105 A	57 A	105 A
$I_N$ output terminal blocks	57 A	57 A	57 A	57 A

Potential distribution 35 R 10	Function	Type	Part No.	Std. Pack
	<ul style="list-style-type: none"> <li>Potential supply 35 mm<sup>2</sup></li> <li>Reducing cross connector 35R10</li> <li>Potential output 10 mm<sup>2</sup></li> </ul>	Supply block, gray	WKF 35 /35	56.735.0053.0
Supply block, gray		WKF 35 /35 BLAU	56.735.0053.6	10
Reducing cross connector <sup>2)</sup>		IVB WKFN 35R10	Z7.285.6427.0	10
Output block, gray		WKFN 10 /35	56.710.0055.0	10
Output block, blue		WKFN 10 /35 BLAU	56.710.0055.6	10
Output block, gray		WKFN 10 D1/2/35	56.710.5055.0	10
Output block, blue		WKFN 10 D1/2/35 BLAU	56.710.5055.6	10
<sup>2)</sup> When cross connectors are used acc. to EN 60079-0 and EN 60079-7 the current must be reduced (values to be requested)				

## Accessories for *fasis* WKFN 16... and WKF 35



	Accessories	Type	Part No.	Std. Pack
	Test plug	ST 2/2,3	Z5.553.2921.0	10
	Screwdriver, uninsulated	DIN 5264 B 1x5,5	06.502.4200.0	5
** When cross connectors are used according to EN 60079-0 and EN 60079-7, the current must be reduced to max. 3.5 A.				

## Ground blocks with tension spring connection

### WKF 1,5 SL/35

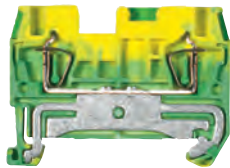
- Ground block with tension spring connection for mounting on TS 35
- Nominal cross section 1.5 mm<sup>2</sup>
- Ex e I/II  II 2GD IM2  
Follow the EX installation instructions on page 149





Description	Type	Part No.	Std. Pack
Ground block, green/yellow	WKF 1,5 SL/35	56.702.9053.0	50
<b>General data</b>			
Width / length / height, incl. TS 7.5	4 mm / 49 mm / 37 mm		
Wire strip length	10 mm		
Approvals	ATEX  KEMA 03 ATEX 2056 U		
<b>Technical data</b>	<b>IEC</b>	<b>UL</b>	<b>CSA</b> 
	EN 60 947-7-2		EN 60 079-0/-7
Cross section fine-stranded	0.08–1.5 mm <sup>2</sup>		0.14–1.5 mm <sup>2</sup>
Cross section solid/stranded	0.08–1.5 mm <sup>2</sup>		0.14–1.5 mm <sup>2</sup>
Cross section, AWG	24–14		24–14
Rated current			
Rated voltage	500 V	300 V	300 V 440 V*
Rated impulse voltage	6 kV		
Pollution degree	3		
<b>Accessories</b>			
End plate, gray	APF 1,5	07.312.8153.0	10
Partition, gray	TWF 1,5	07.312.8253.0	10

### WKF 1,5 D1/2/SL/35

- Duo ground block with tension spring connection for mounting on TS 35
- Nominal cross section 1.5 mm<sup>2</sup>
- Ex e I/II  II 2GD IM2  
Follow the EX installation instructions on page 149





Description	Type	Part No.	Std. Pack
Ground block, green/yellow	WKF 1,5 D1/2/SL/35	56.702.9353.0	50
<b>General data</b>			
Width / length / height, incl. TS 7.5	4 mm / 60 mm / 37 mm		
Wire strip length	10 mm		
Approvals	ATEX  KEMA 03 ATEX 2056 U		
<b>Technical data</b>	<b>IEC</b>	<b>UL</b>	<b>CSA</b> 
	EN 60 947-7-2		EN 60 079-0/-7
Cross section fine-stranded	0.08–1.5 mm <sup>2</sup>		0.14–1.5 mm <sup>2</sup>
Cross section solid/stranded	0.08–1.5 mm <sup>2</sup>		0.14–1.5 mm <sup>2</sup>
Cross section, AWG	24–14		24–14
Rated current			
Rated voltage	500 V	300 V	300 V 440 V*
Rated impulse voltage	6 kV		
Pollution degree	3		
<b>Accessories</b>			
End plate, gray	APF 1,5 D1/2	07.312.8353.0	10
Segment end plate	SAPF 1,5	07.312.8953.0	10
Partition, gray	TWF 1,5 D1/2	07.312.8453.0	10

### WKF 1,5 D2/2/SL/35

- Duo ground block with tension spring connection for mounting on TS 35
- Nominal cross section 1.5 mm<sup>2</sup>
- Ex e I/II  II 2GD IM2  
Follow the EX installation instructions on page 149



Description	Type	Part No.	Std. Pack
Ground block, green/yellow	WKF 1,5 D2/2/SL/35	56.702.9153.0	50
<b>General data</b>			
Width / length / height, incl. TS 7.5	4 mm / 72 mm / 37 mm		
Wire strip length	10 mm		
Approvals	ATEX  KEMA 03 ATEX 2056 U		
<b>Technical data</b>	<b>IEC</b>	<b>UL</b>	<b>CSA</b> 
	EN 60 947-7-2		EN 60 079-0/-7
Cross section fine-stranded	0.08–1.5 mm <sup>2</sup>		0.14–1.5 mm <sup>2</sup>
Cross section solid/stranded	0.08–1.5 mm <sup>2</sup>		0.14–1.5 mm <sup>2</sup>
Cross section, AWG	24–14		24–14
Rated current			
Rated voltage	500 V	300 V	300 V 440 V*
Rated impulse voltage	6 kV		
Pollution degree	3		
<b>Accessories</b>			
End plate, gray	APF 1,5 D2/2	07.312.8553.0	10
Segment end plate	SAPF 1,5	07.312.8953.0	10
Partition, gray	TWF 1,5 D2/2	07.312.8653.0	10

## Accessories for fasis WKF 1.5...

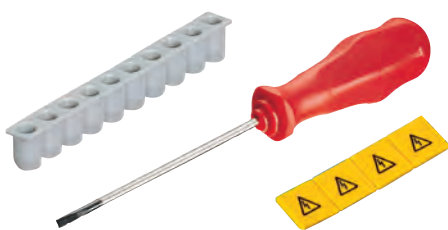









Accessories	Type	Part No.	Std. Pack
Wire entry guide	0.13–0.2 mm <sup>2</sup>	LEL 1,5/1 WEISS	05.564.4253.0 100
	0.25–0.5 mm <sup>2</sup>	LEL 1,5/2 GRAU	05.564.4353.0 100
Cover with warning symbol over 5 blocks	yellow	ADF 1,5/5 GELB	04.343.6953.8 10
Screwdriver, uninsulated	DIN 5264 B 0,4x2,5	06.502.4300.0	5

\* In order to maintain the proper isolation distances, the open side of a ground block is to be covered by an end plate.

### WKFN 2,5 SL/35

- Ground block with tension spring connection for mounting on TS 35
- Nominal cross section 2.5 mm<sup>2</sup>
- Ex e I/II  II 2GD IM2  
Follow the EX installation instructions on page 149









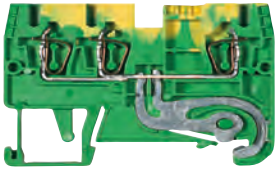

Description	Type	Part No.	Std. Pack
Ground block, green/yellow	WKFN 2,5 SL/35	56.703.9055.0	100
<b>General data</b>			
Width / length / height, incl. TS 7.5	5 mm / 47 mm / 38 mm		
Wire strip length	11 mm		
Approvals	PTB        PTB 04 ATEX 1051 U		
<b>Technical data</b>	<b>IEC</b>	<b>UL</b>	<b>CSA</b> 
	EN 60 947-7-2		EN 60 079-0/-7
Cross section fine-stranded	0.13–2.5 mm <sup>2</sup>		0.2–2.5 mm <sup>2</sup>
Cross section solid/stranded	0.13–4 mm <sup>2</sup>		0.13–4 mm <sup>2</sup>
Cross section, AWG	22–12		24–12
Rated current			
Rated voltage	800 V	600 V	600 V
Rated impulse voltage	8 kV		
Pollution degree	3		
<b>Accessories</b>			
End plate, gray	APFN 2,5	07.312.6755.0	10

### WKFN 2,5 D1/2/SL/35

- Duo-Ground block with tension spring connection for mounting on TS 35
- Nominal cross section 2.5 mm<sup>2</sup>
- Ex e I/II  II 2GD IM2  
Follow the EX installation instructions on page 149









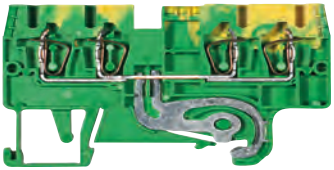

Description	Type	Part No.	Std. Pack
Ground block, green/yellow	WKFN 2,5 D1/2/SL/35	56.703.9355.0	100
<b>General data</b>			
Width / length / height, incl. TS 7.5	5 mm / 60 mm / 38 mm		
Wire strip length	11 mm		
Approvals	PTB        PTB 04 ATEX 1051 U		
<b>Technical data</b>	<b>IEC</b>	<b>UL</b>	<b>CSA</b> 
	EN 60 947-7-2		EN 60 079-0/-7
Cross section fine-stranded	0.13–2.5 mm <sup>2</sup>		0.2–2.5 mm <sup>2</sup>
Cross section solid/stranded	0.13–4 mm <sup>2</sup>		0.13–4 mm <sup>2</sup>
Cross section, AWG	22–12		24–12
Rated current			
Rated voltage	800 V	600 V	600 V
Rated impulse voltage	8 kV		
Pollution degree	3		
<b>Accessories</b>			
End plate, gray	APFN 2,5 D1/2	07.312.6955.0	10

### WKFN 2,5 D2/2/SL/35

- Duo ground block with tension spring connection for mounting on TS 35
- Nominal cross section 2.5 mm<sup>2</sup>
- Ex e I/II  II 2GD IM2  
Follow the EX installation instructions on page 149



Description	Type	Part No.	Std. Pack
Ground block, green/yellow	WKFN 2,5 D2/2/SL/35	56.703.9155.0	100
<b>General data</b>			
Width / length / height, incl. TS 7.5	5 mm / 72 mm / 38 mm		
Wire strip length	11 mm		
Approvals	PTB        PTB 04 ATEX 1051 U		
<b>Technical data</b>	<b>IEC</b>	<b>UL</b>	<b>CSA</b> 
	EN 60 947-7-2		EN 60 079-0/-7
Cross section fine-stranded	0.13–2.5 mm <sup>2</sup>		0.2–2.5 mm <sup>2</sup>
Cross section solid/stranded	0.13–4 mm <sup>2</sup>		0.13–4 mm <sup>2</sup>
Cross section, AWG	22–12		24–12
Rated current			
Rated voltage	800 V	600 V	600 V
Rated impulse voltage	8 kV		
Pollution degree	3		
<b>Accessories</b>			
End plate, gray	APFN 2,5 D2/2	07.312.7155.0	10

## Accessories for *fasis* WKFN 2,5...

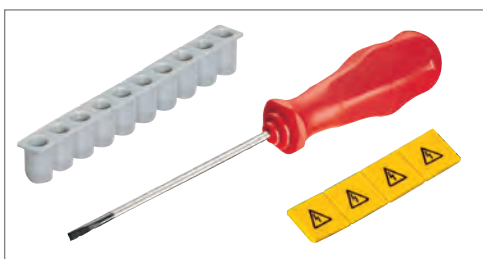





Accessories	Type	Part No.	Std. Pack
Wire entry guide	0.13–0.2 mm <sup>2</sup>	LELN 2,5/1 WEISS	05.564.3755.0
	0.25–0.5 mm <sup>2</sup>	LELN 2,5/2 GRAU	05.564.3855.0
	0.75–1.0 mm <sup>2</sup>	LELN 2,5/3 SCHWARZ	05.564.3955.0
Cover with warning symbol over 4 blocks	yellow	ADFN 2,5/4 GELB	04.343.8353.8
Screwdriver, uninsulated		DIN 5264 B 0,6x3,5	06.502.4000.0
Screwdriver, uninsulated, MINI		DIN 5264 B 0,6x3,5 M	06.502.5000.0

## Ground blocks with tension spring connection

### WKFN 4 SL/35

- Ground block with tension spring connection for mounting on TS 35
- Nominal cross section 4 mm<sup>2</sup>
- Ex e I/II  II 2GD IM2  
Follow the EX installation instructions on page 149







Description	Type	Part No.	Std. Pack
Ground block, green/yellow	WKFN 4 SL/35	56.704.9055.0	100
<b>General data</b>			
Width / length / height, incl. TS 7.5	6 mm / 51 mm / 38 mm		
Wire strip length	11 mm		
Approvals	PTB      PTB 05 ATEX 1104 U		
<b>Technical data</b>		<b>IEC</b>	<b>UL</b>
	EN 60 947-7-2		
Cross section fine-stranded	0.13–4 mm <sup>2</sup>		0.13–4 mm <sup>2</sup>
Cross section solid/stranded	0.13–6 mm <sup>2</sup>		0.2–6 mm <sup>2</sup>
Cross section, AWG		24–10	24–10
Rated current			
Rated voltage	800 V	600 V	600 V
Rated impulse voltage	8 kV		
Pollution degree	3		
<b>Accessories</b>			
End plate, gray	APFN 4	07.312.9255.0	10

### WKFN 4 D1/2/SL/35

- Duo ground block with tension spring connection for mounting on TS 35
- Nominal cross section 4 mm<sup>2</sup>
- Ex e I/II  II 2GD IM2  
Follow the EX installation instructions on page 149





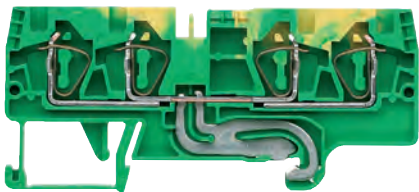

Description	Type	Part No.	Std. Pack
Ground block, green/yellow	WKFN 4 D1/2/SL/35	56.704.9355.0	100
<b>General data</b>			
Width / length / height, incl. TS 7.5	6 mm / 67 mm / 38 mm		
Wire strip length	11 mm		
Approvals	PTB      PTB 05 ATEX 1104 U		
<b>Technical data</b>		<b>IEC</b>	<b>UL</b>
	EN 60 947-7-2		
Cross section fine-stranded	0.13–4 mm <sup>2</sup>		0.13–4 mm <sup>2</sup>
Cross section solid/stranded	0.13–6 mm <sup>2</sup>		0.2–6 mm <sup>2</sup>
Cross section, AWG		24–10	24–10
Rated current			
Rated voltage	800 V	600 V	600 V
Rated impulse voltage	8 kV		
Pollution degree	3		
<b>Accessories</b>			
End plate, gray	APFN 4 D1/2	07.312.9455.0	10

### WKFN 4 D2/2/SL/35

- Duo ground block with tension spring connection for mounting on TS 35
- Nominal cross section 4 mm<sup>2</sup>
- Ex e I/II  II 2GD IM2  
Follow the EX installation instructions on page 149



Description	Type	Part No.	Std. Pack
Ground block, green/yellow	WKFN 4 D2/2/SL/35	56.704.9155.0	100
<b>General data</b>			
Width / length / height, incl. TS 7.5	6 mm / 82 mm / 38 mm		
Wire strip length	11 mm		
Approvals	PTB      PTB 05 ATEX 1104 U		
<b>Technical data</b>		<b>IEC</b>	<b>UL</b>
	EN 60 947-7-2		
Cross section fine-stranded	0.13–4 mm <sup>2</sup>		0.13–4 mm <sup>2</sup>
Cross section solid/stranded	0.13–6 mm <sup>2</sup>		0.2–6 mm <sup>2</sup>
Cross section, AWG		24–10	24–10
Rated current			
Rated voltage	800 V	600 V	600 V
Rated impulse voltage	8 kV		
Pollution degree	3		
<b>Accessories</b>			
End plate, gray	APFN 4 D2/2	07.312.9055.0	10

## Accessories for *fasis* WKFN 4...

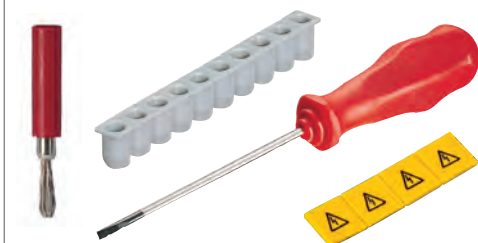





Accessories	Type	Part No.	Std. Pack
Wire entry guide	0.13–0.2 mm <sup>2</sup>	LEL 4/1 WEISS	05.561.8553.0
	0.25–0.5 mm <sup>2</sup>	LEL 4/2 GRAU	05.561.8653.0
	0.75–1.0 mm <sup>2</sup>	LEL 4/3 SCHWARZ	05.561.8753.0
Cover with warning symbol over 4 blocks	yellow	ADF 4/4 GELB	04.343.6153.8
Test plug		ST 2/2,3	Z5.553.2921.0
Screwdriver, uninsulated		DIN 5264 B 0,6x3,5	06.502.4000.0
Screwdriver, uninsulated, MINI		DIN 5264 B 0,6x3,5 M	06.502.5000.0

### WKFN 6 SL/35

- Ground block with tension spring connection for mounting on TS 35
- Nominal cross section 6 mm<sup>2</sup>
- Ex e I/II  II 2GD IM2  
Follow the EX installation instructions on page 149







Description	Type	Part No.	Std. Pack
Ground block, green/yellow	WKFN 6 SL/35	56.706.9055.0	100
<b>General data</b>			
Width / length / height, incl. TS 7.5	8 mm / 66 mm / 45 mm		
Wire strip length	12 mm		
Approvals	PTB    PTB 06 ATEX 1075 U		
<b>Technical data</b>	<b>IEC</b>	<b>UL</b>	<b>CSA</b> 
	EN 60 947-7-2		EN 60 079-0/-7
Cross section fine-stranded	0.2–6 mm <sup>2</sup>		0.2–6 mm <sup>2</sup>
Cross section solid/stranded	1.5–10 mm <sup>2</sup>		1.5–10 mm <sup>2</sup>
Cross section, AWG		24–8	24–8
Rated current			
Rated voltage	800 V	600 V	600 V
Rated impulse voltage	8 kV		
Pollution degree	3		
<b>Accessories</b>			
End plate, gray	APFN 6	07.313.0455.0	10

### WKFN 6 D1/2/SL/35

- Duo ground block with tension spring connection for mounting on TS 35
- Nominal cross section 6 mm<sup>2</sup>
- Ex e I/II  II 2GD IM2  
Follow the EX installation instructions on page 149



Description	Type	Part No.	Std. Pack
Ground block, green/yellow	WKFN 6 D1/2/SL/35	56.706.9355.0	100
<b>General data</b>			
Width / length / height, incl. TS 7.5	8 mm / 90 mm / 45 mm		
Wire strip length	12 mm		
Approvals	PTB    PTB 06 ATEX 1075 U		
<b>Technical data</b>	<b>IEC</b>	<b>UL</b>	<b>CSA</b> 
	EN 60 947-7-2		EN 60 079-0/-7
Cross section fine-stranded	0.2–6 mm <sup>2</sup>		0.2–6 mm <sup>2</sup>
Cross section solid/stranded	1.5–10 mm <sup>2</sup>		1.5–10 mm <sup>2</sup>
Cross section, AWG		24–8	24–8
Rated current		50 A	
Rated voltage	800 V	600 V	600 V
Rated impulse voltage	8 kV		
Pollution degree	3		
<b>Accessories</b>			
End plate, gray	APFN 6 D1/2	07.313.0655.0	10

## Accessories for *fasis* WKFN 6...

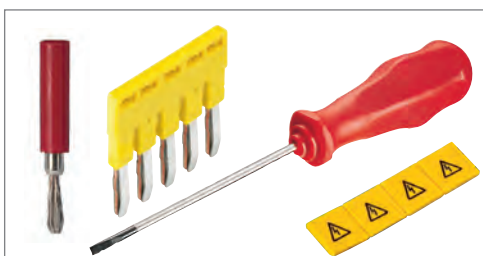

Accessories	Type	Part No.	Std. Pack	
Cross connector, insulated*	2 pole	IVB WKFN 6–2	Z7.282.5227.0	10
	3 pole	IVB WKFN 6–3	Z7.282.5327.0	10
	4 pole	IVB WKFN 6–4	Z7.282.5427.0	10
	5 pole	IVB WKFN 6–5	Z7.282.5527.0	10
	Cover with warning symbol over 4 blocks	yellow	ADF 6/4 GELB	04.343.6253.8
Test plug		ST 2/2,3	Z5.553.2921.0	10
Screwdriver, uninsulated		DIN 5264 B 0,8x4	06.502.4100.0	5





\* When cross connectors are used according to EN 60079-0 and EN 60079-7, the current must be reduced to max. 3.5 A.

## Ground blocks with tension spring connection

### WKFN 10 SL/35

- Ground block with tension spring connection for mounting on TS 35
- Nominal cross section 10 mm<sup>2</sup>
- Ex e I/II  II 2GD IM2  
Follow the EX installation instructions on page 149





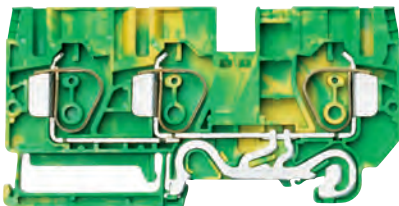

Description	Type	Part No.	Std. Pack
Ground block, green/yellow	WKFN 10 SL/35	56.710.9055.0	50
<b>General data</b>			
Width / length / height, incl. TS 7.5	10 mm / 72 mm / 50 mm		
Wire strip length	15 mm		
Approvals	PTB     PTB 06 ATEX 1075 U		
<b>Technical data</b>	<b>IEC</b>	<b>UL</b>	<b>CSA</b> 
	EN 60 947-7-2		EN 60 079-0/-7
Cross section fine-stranded	0.2–10 mm <sup>2</sup>		0.2–10 mm <sup>2</sup>
Cross section solid/stranded	1.5–16 mm <sup>2</sup>		1.5–16 mm <sup>2</sup>
Cross section, AWG	16–6		16–6
Rated current			
Rated voltage	1000 V	600 V	600 V
Rated impulse voltage	8 kV		
Pollution degree	3		
<b>Accessories</b>			
End plate, gray	Type APFN 10/35	Part No. 07.313.0855.0	Std. Pack 10

### WKFN 10 D1/2/SL/35

- Duo ground block with tension spring connection for mounting on TS 35
- Nominal cross section 10 mm<sup>2</sup>
- Ex e I/II  II 2GD IM2  
Follow the EX installation instructions on page 149





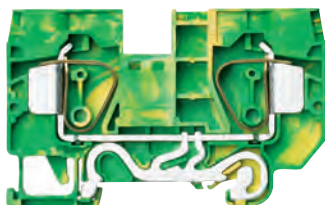

Description	Type	Part No.	Std. Pack
Ground block, green/yellow	WKFN 10 D1/2/SL/35	56.710.9355.0	50
<b>General data</b>			
Width / length / height, incl. TS 7.5	10 mm / 98 mm / 50 mm		
Wire strip length	15 mm		
Approvals	PTB     PTB 06 ATEX 1075 U		
<b>Technical data</b>	<b>IEC</b>	<b>UL</b>	<b>CSA</b> 
	EN 60 947-7-2		EN 60 079-0/-7
Cross section fine-stranded	0.2–10 mm <sup>2</sup>		0.2–10 mm <sup>2</sup>
Cross section solid/stranded	1.5–16 mm <sup>2</sup>		1.5–16 mm <sup>2</sup>
Cross section, AWG	16–6		
Rated current			
Rated voltage	1000 V	600 V	
Rated impulse voltage	8 kV		
Pollution degree	3		
<b>Accessories</b>			
End plate, gray	Type APFN 10 D1/2	Part No. 07.313.1055.0	Std. Pack 10

### WKFN 16 SL/35

- Ground block with tension spring connection for mounting on TS 35
- Nominal cross section 16 mm<sup>2</sup>
- Ex e I/II  II 2GD IM2  
Follow the EX installation instructions on page 149







Description	Type	Part No.	Std. Pack
Ground block, green/yellow	WKFN 16 SL/35	56.716.9055.0	50
<b>General data</b>			
Width / length / height, incl. TS 7.5	12 mm / 79 mm / 50 mm		
Wire strip length	16 mm		
Approvals	PTB     PTB 06 ATEX 1075 U		
<b>Technical data</b>	<b>IEC</b>	<b>UL</b>	<b>CSA</b> 
	EN 60 947-7-2		EN 60 079-0/-7
Cross section fine-stranded	0.2–16 mm <sup>2</sup>		0.2–16 mm <sup>2</sup>
Cross section solid/stranded	1.5–25 mm <sup>2</sup>		1.5–25 mm <sup>2</sup>
Cross section, AWG	16–4		16–4
Rated current			
Rated voltage	1000 V	600 V	600 V
Rated impulse voltage	8 kV		
Pollution degree	3		
<b>Accessories</b>			
End plate, gray	Type APFN 16	Part No. 07.313.1255.0	Std. Pack 10

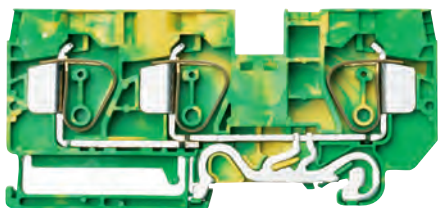

### WKFN 16 D1/2/SL/35

- Duo ground block with tension spring connection for mounting on TS 35
- Nominal cross section 16 mm<sup>2</sup>
- Ex e I/II  II 2GD IM2  
Follow the EX installation instructions on page 149





Description	Type	Part No.	Std. Pack
Ground block, green/yellow	WKFN 16 D1/2/SL/35	56.716.9355.0	50
<b>General data</b>			
Width / length / height, incl. TS 7.5	12 mm / 107 mm / 50 mm		
Wire strip length	16 mm		
Approvals	PTB    PTB 06 ATEX 1075 U		
<b>Technical data</b>	<b>IEC</b>	<b>UL</b>	<b>CSA</b> 
	EN 60 947-7-2		EN 60 079-0/-7
Cross section fine-stranded	0.2–16 mm <sup>2</sup>		0.2–16 mm <sup>2</sup>
Cross section solid/stranded	1.5–25 mm <sup>2</sup>		1.5–25 mm <sup>2</sup>
Cross section, AWG			16–4
Rated current			
Rated voltage	1000 V		600 V
Rated impulse voltage	8 kV		
Pollution degree	3		
<b>Accessories</b>			
End plate, gray	Type	Part No.	Std. Pack
	APFN 16 D1/2	07.313.1455.	10

### WKF 35 SL/35

- Ground block with tension spring connection for mounting on TS 35
- Nominal cross section 35 mm<sup>2</sup>
- Ex e II  II 2GD  
Follow the EX installation instructions on page 149



Description	Type	Part No.	Std. Pack
Ground block, green/yellow	WKF 35 SL/35	56.735.9053.0	10
<b>General data</b>			
Width / length / height, incl. TS 7.5	16 mm / 100 mm / 59 mm		
Wire strip length	18 mm		
Approvals	ATEX   KEMA 03 ATEX 2057 U		
<b>Technical data</b>	<b>IEC</b>	<b>UL</b>	<b>CSA</b> 
	EN 60 947-7-1		EN 60 079-0/-7
Cross section fine-stranded	2.5–35 mm <sup>2</sup>		2.5–35 mm <sup>2</sup>
Cross section solid/stranded	2.5–35 mm <sup>2</sup>		2.5–35 mm <sup>2</sup>
Cross section, AWG	12–2	12–2	
Rated current			
Rated voltage	800 V	600 V	600 V
Rated impulse voltage	8 kV		690 V
Pollution degree	3		
<b>Accessories</b>			
Cross connector, insulated	Type	Part No.	Std. Pack
	2 pole	IVB WKF 35–2	Z7.285.6227.0
Cover with warning symbol over 4 blocks		ADF 35/5 GELB	04.343.9253.8
Test plug		ST 2/2,3	Z5.553.2921.0

## Accessories for *fasis* WKFN 10 SL/... and WKFN 16 SL/...

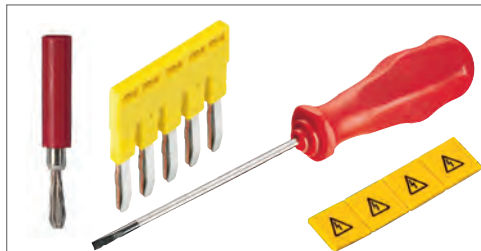

Accessories	Type	Part No.	Std. Pack
Test plug	ST 2/2,3	Z5.553.2921.0	10
Screwdriver, uninsulated	DIN 5264 B 1x5,5	06.502.4200.0	5
<b>for WKFN 10 ...</b>			
Cross connector, insulated**	2 pole	IVB WKF 10–2	Z7.283.8227.0
Cover with warning symbol over 4 blocks	yellow	ADF 10/4 GELB	04.343.6453.8
<b>for WKFN 16 ...</b>			
Cross connector, insulated*	2 pole	IVB WKF 16–2	Z7.284.4227.0
Cover with warning symbol over 4 blocks	yellow	ADF 16/4 GELB	04.343.6653.8

\*\* When cross connectors are used acc. to EN 60079-0 and EN 60079-7 the current must be reduced to 4 A/40 K or 5 A/45 K for type WKFN 10/35.

## Multi-tier terminal blocks with tension spring connection

### WKF 1,5 E2/35

- Multi-tier block with tension spring connection for mounting on TS 35
- Nominal cross section 1.5 mm<sup>2</sup>
- Ex e II  II 2GD  
Follow the EX installation instructions on page 149



Description	Type	Part No.	Std. Pack
Multi-tier block, gray	WKF 1,5 E2/35	56.702.7653.0	50
<b>General data</b>			
Width / length / height, incl. TS 7.5	4 mm / 68 mm / 47 mm		
Wire strip length	10 mm		
Approvals	ATEX  KEMA 03 ATEX 2056 U		
<b>Technical data</b>	<b>IEC</b>	<b>UL</b>	<b>CSA</b>
	EN 60 947-7-1		EN 60 079-0/-7
Cross section fine-stranded	0.08–1.5 mm <sup>2</sup>		0.14–1.5 mm <sup>2</sup>
Cross section solid/stranded	0.08–1.5 mm <sup>2</sup>		0.14–1.5 mm <sup>2</sup>
Cross section, AWG	26–14		26–14
Rated current	17,5 A	15 A	15 A
Rated voltage	500 V	300 V	300 V
Rated impulse voltage	6 kV		
Pollution degree	3		
<b>Note</b>	<sup>1)</sup> Rated current when using cross connectors <sup>2)</sup> For maintaining the proper isolation distances, the open side of a feed-through terminal block as well as both sides of a jumper are to be covered by partitions.		

### WKF 1,5 E2/VB/35

- Multi-tier block, vertically connected, with tension spring connection for mounting on TS 35
- Nominal cross section 1.5 mm<sup>2</sup>
- Ex e II  II 2GD  
Follow the EX installation instructions on page 149



Description	Type	Part No.	Std. Pack
Multi-tier block, black	WKF 1,5 E2/VB/35	56.702.6953.1	50
<b>General data</b>			
Width / length / height, incl. TS 7.5	4 mm / 68 mm / 47 mm		
Wire strip length	10 mm		
Approvals	ATEX  KEMA 03 ATEX 2056 U		
<b>Technical data</b>	<b>IEC</b>	<b>UL</b>	<b>CSA</b>
	EN 60 947-7-1		EN 60 079-0/-7
Cross section fine-stranded	0.08–1.5 mm <sup>2</sup>		0.14–1.5 mm <sup>2</sup>
Cross section solid/stranded	0.08–1.5 mm <sup>2</sup>		0.14–1.5 mm <sup>2</sup>
Cross section, AWG	26–14		26–14
Rated current	17,5 A	15 A	15 A
Rated voltage	500 V	300 V	300 V
Rated impulse voltage	6 kV		
Pollution degree	3		
<b>Note</b>	<sup>1)</sup> Rated current when using cross connectors <sup>2)</sup> For maintaining the proper isolation distances, the open side of a feed-through terminal block as well as both sides of a jumper are to be covered by partitions.		

### WKF 1,5 E2/SL/35

- Multi-tier ground block with tension spring connection for mounting on TS 35
- Nominal cross section 1.5 mm<sup>2</sup>
- Ex e II  II 2GD  
Follow the EX installation instructions on page 149



Description	Type	Part No.	Std. Pack
Multi-tier ground block, green/yellow	WKF 1,5 E2/SL/35	56.702.9253.0	50
<b>General data</b>			
Width / length / height, incl. TS 7.5	4 mm / 68 mm / 47 mm		
Wire strip length	10 mm		
Approvals	ATEX  KEMA 03 ATEX 2056 U		
<b>Technical data</b>	<b>IEC</b>	<b>UL</b>	<b>CSA</b>
	EN 60 947-7-2		EN 60 079-0/-7
Cross section fine-stranded	0.08–1.5 mm <sup>2</sup>		0.14–1.5 mm <sup>2</sup>
Cross section solid/stranded	0.08–1.5 mm <sup>2</sup>		0.14–1.5 mm <sup>2</sup>
Cross section, AWG	26–14		26–14
Rated current			<sup>1)</sup>
Rated voltage	500 V	300 V	300 V
Rated impulse voltage	6 kV		
Pollution degree	3		
<b>Note</b>	<sup>1)</sup> For maintaining the proper isolation distances, the open side of a feed-through terminal block as well as both sides of a jumper are to be covered by partitions.		

## Accessories for *fasis* WKF 1,5...



Accessories		Type	Part No.	Std. Pack
End plate	gray	APF 1,5 E2	07.312.8753.0	10
Partition	gray	TWF 1,5 E2	07.312.8853.0	10
Cross connector, insulated	2 pole	IVB WKF 1,5-2	Z7.268.0227.0	10
	3 pole	IVB WKF 1,5-3	Z7.268.0327.0	10
	4 pole	IVB WKF 1,5-4	Z7.268.0427.0	10
	5 pole	IVB WKF 1,5-5	Z7.268.0527.0	10
	10 pole	IVB WKF 1,5-10	Z7.268.1027.0	10
Wire entry guide	0.13-0.2 mm <sup>2</sup>	LEL 1,5/1 WEISS	05.564.4253.0	10
	0.25-0.5 mm <sup>2</sup>	LEL 1,5/2 GRAU	05.564.4353.0	10
Cover with warning symbol over 5 blocks	yellow	ADF 1,5/5 GELB	04.343.6953.8	10
Marking tag carrier, 2-fold		BT 4/2	04.243.0953.0	100
Screwdriver, uninsulated		DIN 5264 B 0,4x2,5	06.502.4300.0	5

## Multi-tier blocks with tension spring connection





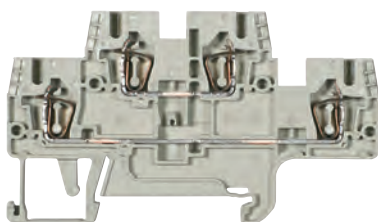

### WKFN 2,5 E/35

### WKFN 2,5 E/N/D/35

- Multi-tier block with tension spring connection for mounting on TS 35
- Nominal cross section 2.5 mm<sup>2</sup>
- Ex e I/II  II 2GD IM2  
Follow the EX installation instructions on page 149



Description	Type	Part No.	Std. Pack
Multi-tier block, gray	WKFN 2,5 E/35	56.703.7055.0	100
Multi-tier block, combined, gray	WKFN 2,5 E/N/D/35	56.703.7655.0	100

General data				
Width / length / height, incl. TS 7.5	5 mm / 82 mm / 48 mm			
Wire strip length	11 mm			
Approvals	PTB      		PTB 04 ATEX 1051 U	
Technical data	IEC	UL	CSA	Ex
	EN 60 947-7-1			EN 60 079-0/-7
Cross section fine-stranded	0.13–2.5 mm <sup>2</sup>			0.2–2.5 mm <sup>2</sup>
Cross section solid/stranded	0.13–4 mm <sup>2</sup>			0.13–4 mm <sup>2</sup>
Cross section, AWG		22–12	24–12	
Rated current	24 A	20 A	24 A	20/21,5 A <sup>1)</sup>
Rated voltage	500 V	300 V	300 V	440/275 V <sup>2)</sup>
Rated impulse voltage	6 kV			
Pollution degree	3			
<b>Note</b>	<sup>1)</sup> 1. value at 40 K / 2. value at 45 K <sup>2)</sup> When using cross connectors on the upper tier			

### WKFN 2,5 E/N/D/35





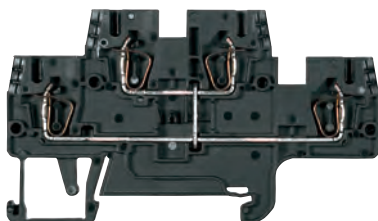

	Function	Color ID
Upper tier	Feed-through	blue
Lower tier	Feed-through	gray

### WKFN 2,5 E/VB/35

- Multi-tier block, vertically connected, with tension spring connection for mounting on TS 35
- Nominal cross section 2.5 mm<sup>2</sup>
- Ex e I/II  II 2GD IM2  
Follow the EX installation instructions on page 149



Description	Type	Part No.	Std. Pack
Multi-tier block, black	WKFN 2,5 E/VB/35	56.703.6955.1	100





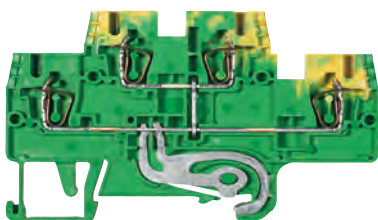

General data				
Width / length / height, incl. TS 7.5	5 mm / 82 mm / 48 mm			
Wire strip length	11 mm			
Approvals	PTB      		PTB 04 ATEX 1051 U	
Technical data	IEC	UL	CSA	Ex
	EN 60 947-7-1			EN 60 079-0/-7
Cross section fine-stranded	0.13–2.5 mm <sup>2</sup>			0.2–2.5 mm <sup>2</sup>
Cross section solid/stranded	0.13–4 mm <sup>2</sup>			0.13–4 mm <sup>2</sup>
Cross section, AWG		22–12	24–12	
Rated current	24 A	20 A	24 A	20/21,5 A <sup>1)</sup>
Rated voltage	500 V	600 V	600 V	440 V
Rated impulse voltage	6 kV			
Pollution degree	3			
<b>Note</b>	<sup>1)</sup> 1. value at 40 K / 2. value at 45 K			

### WKFN 2,5 E/SL/35

- Ground block with tension spring connection for mounting on TS 35
- Nominal cross section 2.5 mm<sup>2</sup>
- Ex e I/II  II 2GD IM2  
Follow the EX installation instructions on page 149



Description	Type	Part No.	Std. Pack
Ground block, green/yellow	WKFN 2,5 E/SL/35	56.703.8955.0	100

General data				
Width / length / height, incl. TS 7.5	5 mm / 82 mm / 48 mm			
Wire strip length	11 mm			
Approvals	PTB      		PTB 04 ATEX 1051 U	
Technical data	IEC	UL	CSA	Ex
	EN 60 947-7-2			EN 60 079-0/-7
Cross section fine-stranded	0.13–2.5 mm <sup>2</sup>			0.2–2.5 mm <sup>2</sup>
Cross section solid/stranded	0.13–4 mm <sup>2</sup>			0.13–4 mm <sup>2</sup>
Cross section, AWG		22–12	24–12	
Rated current				
Rated voltage	500 V	600 V	600 V	
Rated impulse voltage	6 kV			
Pollution degree	3			

**WKFN 2,5 E/D/SL/35**  
**WKFN 2,5 E/N/SL/35**

- Multi-tier block, combined, with tension spring connection for mounting on TS 35
- Nominal cross section 2.5 mm<sup>2</sup>

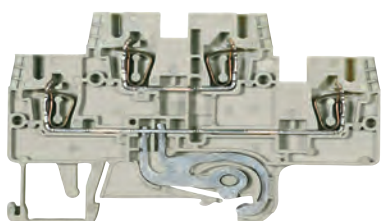

Description	Type	Part No.	Std. Pack
Multi-tier block, combined, gray	WKFN 2,5 E/D/SL/35	56.703.7855.0	100
Multi-tier block, combined, gray	WKFN 2,5 E/N/SL/35	56.703.7755.0	100
<b>General data</b>			
Width / length / height, incl. TS 7.5	5 mm / 82 mm / 48 mm		
Wire strip length	11 mm		
Approvals			
<b>Technical data</b>		<b>IEC</b>	<b>UL</b> <b>CSA</b>
	EN 60 947-7-1		
Cross section fine-stranded	0.13–2.5 mm <sup>2</sup>		
Cross section solid/stranded	0.13–4 mm <sup>2</sup>		
Cross section, AWG	22–12      24–12		
Rated current	24 A	20 A	24 A
Rated voltage	500 V	300 V	300 V
Rated impulse voltage	6 kV		
Pollution degree	3		

**WKFN 2,5 E/D/SL/35**

	Function	Color ID
Upper tier	Feed-through	gray
Lower tier	Ground conductor	green/yellow

**WKFN 2,5 E/N/SL/35**

	Function	Color ID
Upper tier	Feed-through	blue
Lower tier	Ground conductor	green/yellow

**WKFN 2,5 E...G**

- Multi-tier function block with tension spring connection for mounting on TS 35
- Nominal cross section 2.5 mm<sup>2</sup>

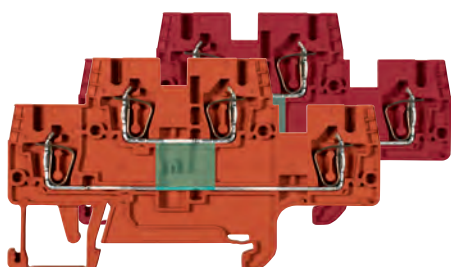

Description	Type	Part No.	Std. Pack
Multi-tier function block, red	WKFN 2,5 E.../35	56.703.XX55.5	100
Multi-tier function block, orange	WKFN 2,5 E.../35	56.703.XX55.9	100
<b>General data</b>			
Width / length / height, incl. TS 7.5	5 mm / 82 mm / 48 mm		
Wire strip length	11 mm		
Approvals			
<b>Technical data</b>		<b>IEC</b>	<b>UL</b> <b>CSA</b>
	EN 60947-7-1		
Cross section fine-stranded	0.13–2.5 mm <sup>2</sup>		
Cross section solid/stranded	0.13–4 mm <sup>2</sup>		
Cross section, AWG	22–12      24–12		

**Function diagram for fasis WKFN 2,5 E...**

The multi-tier block is available on request as a function block for a wide variety of switching tasks.

56.703.7555.9 56.703.7555.5					
56.703.8255.5		I = 1 A U = 1000 V	56.703.7455.9 LED red		R = 4.7 kΩ P = 0.5 W U = 24 V DC
56.703.7155.5 56.703.7155.9			56.703.7255.5 LED red		R = 4.7 kΩ P = 0.5 W U = 24 V DC
56.703.8055.9		I = 1 A U = 1000 V	56.703.8355.5		I = 1 A U = 1000 V
			56.703.7355.5		R = 680 kΩ P = 0.25 W U = 100-500 V

**Accessories for fasis WKFN 2,5 E/...**

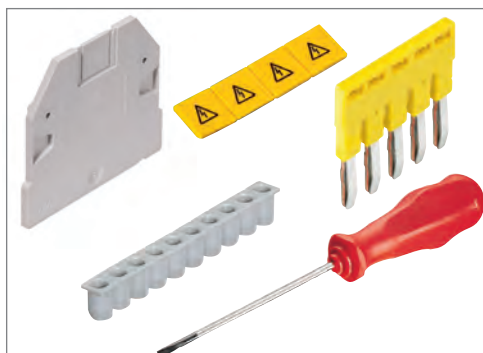

Accessories	Type	Part No.	Std. Pack
End plate	gray APFN 2,5 E	07.312.7355.0	10
Partition	gray WFN 2,5 E	07.312.7455.0	10
Cross connector, insulated	2 pole IVB WKF 2,5–2	Z7.280.6227.0	10
	3 pole IVB WKF 2,5–3	Z7.280.6327.0	10
	4 pole IVB WKF 2,5–4	Z7.280.6427.0	10
	5 pole IVB WKF 2,5–5	Z7.280.6527.0	10
	10 pole IVB WKF 2,5–10	Z7.280.7027.0	20
	20 pole IVB WKF 2,5–20	Z7.280.8027.0	20
Vertical cross connector	1 pole IVB WKF-V	Z7.261.1127.0	10
Wire entry guide	0.13–0.2 mm <sup>2</sup> LELN 2,5/1 WEISS	05.564.3755.0	100
	0.25–0.5 mm <sup>2</sup> LELN 2,5/2 GRAU	05.564.3855.0	100
	0.75–1.0 mm <sup>2</sup> LELN 2,5/3 SCHWARZ	05.564.3955.0	100
Cover with warning symbol over 4 blocks	yellow ADFN 2,5/4 GELB	04.343.8353.8	10
Marking tag carrier, 3-fold	BT 5/3	04.243.0755.0	100







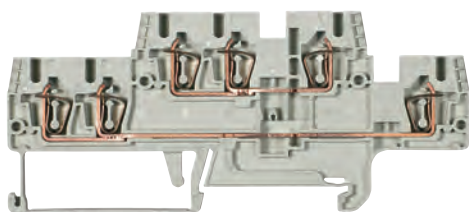













## Duo multi-tier terminal blocks with tension spring connection

### WKFN 2,5 E1/2/35 WKFN 2,5 E1/2/N/D/35

- Duo multi-tier block with tension spring connection for mounting on TS 35
- Nominal cross section 2.5 mm<sup>2</sup>
- Ex e I/II  II 2GD IM2  
Follow the EX installation instructions on page 149



Description	Type	Part No.	Std. Pack
Multi-tier block, gray	WKFN 2,5 E1/2/35	56.703.6055.0	50
Multi-tier block, combined, gray	WKFN 2,5 E1/2/N/D/35	56.703.6355.0	50







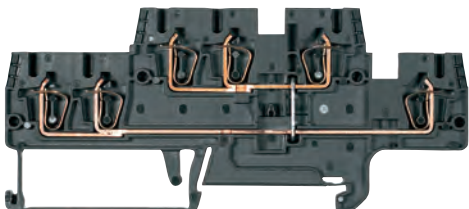













General data				
Width / length / height, incl. TS 7.5	5 mm / 107 mm / 48 mm			
Wire strip length	11 mm			
Approvals	PTB                    		PTB 04 ATEX 1051 U	
Technical data	IEC	UL	CSA	
	EN 60 947-7-1			EN 60 079-0/-7
Cross section fine-stranded	0.13–2.5 mm <sup>2</sup>			0.2–2.5 mm <sup>2</sup>
Cross section solid/stranded	0.13–4 mm <sup>2</sup>			0.13–4 mm <sup>2</sup>
Cross section, AWG		22–12	24–12	
Rated current	22 A	20 A	24 A	20/21 A <sup>1)</sup>
Rated voltage	500 V	300 V	300 V	440/275 V <sup>2)</sup>
Rated impulse voltage	6 kV			
Pollution degree	3			
<b>Note</b>	<sup>1)</sup> 1. value at 40K / 2. value at 45K <sup>2)</sup> When using cross connectors on the upper tier			

### WKFN 2,5 E1/2/VB/35

- Duo multi-tier block, vertically connected, with tension spring connection for mounting on TS 35
- Nominal cross section 2.5 mm<sup>2</sup>
- Ex e I/II  II 2GD IM2  
Follow the EX installation instructions on page 149



Description	Type	Part No.	Std. Pack
Multi-tier block, black	WKFN 2,5 E1/2/VB/35	56.703.5955.1	50

General data				
Width / length / height, incl. TS 7.5	5 mm / 107 mm / 48 mm			
Wire strip length	11 mm			
Approvals	PTB                    		PTB 04 ATEX 1051 U	
Technical data	IEC	UL	CSA	
	EN 60 947-7-1			EN 60 079-0/-7
Cross section fine-stranded	0.13–2.5 mm <sup>2</sup>			0.2–2.5 mm <sup>2</sup>
Cross section solid/stranded	0.13–4 mm <sup>2</sup>			0.13–4 mm <sup>2</sup>
Cross section, AWG		22–12	24–12	
Rated current	22 A	20 A	24 A	20/21 A <sup>1)</sup>
Rated voltage	500 V	300 V	300 V	440 V
Rated impulse voltage	6 kV			
Pollution degree	3			
<b>Note</b>	<sup>1)</sup> 1. value at 40K / 2. value at 45K			







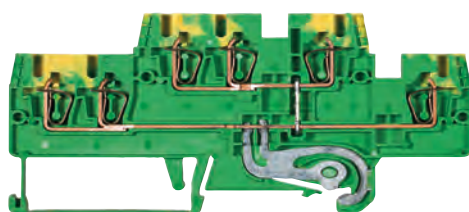













Accessories	Type	Part No.	Std. Pack
Partition, gray	TWFN 2,5 E1/2	07.312.7855.0	10

### WKFN 2,5 E1/2/SL/35

- Duo multi-tier ground block with tension spring connection for mounting on TS 35
- Nominal cross section 2.5 mm<sup>2</sup>
- Ex e I/II  II 2GD IM2  
Follow the EX installation instructions on page 149



Description	Type	Part No.	Std. Pack
Ground block, green/yellow	WKFN 2,5 E1/2/SL/35	56.703.6255.0	50

General data				
Width / length / height, incl. TS 7.5	5 mm / 107 mm / 48 mm			
Wire strip length	11 mm			
Approvals	PTB                    		PTB 04 ATEX 1051 U	
Technical data	IEC	UL	CSA	
	EN 60 947-7-2			EN 60 079-0/-7
Cross section fine-stranded	0.13–2.5 mm <sup>2</sup>			0.2–2.5 mm <sup>2</sup>
Cross section solid/stranded	0.13–4 mm <sup>2</sup>			0.13–4 mm <sup>2</sup>
Cross section, AWG		22–12	24–12	
Rated current				
Rated voltage	500 V	600 V	600 V	
Rated impulse voltage	6 kV			
Pollution degree	3			

**WKFN 2,5 E1/2/D/SL/35**  
**WKFN 2,5 E1/2/N/SL/35**

- Duo multi-tier block, combined, with tension spring connection for mounting on TS 35
- Nominal cross section 2.5 mm<sup>2</sup>

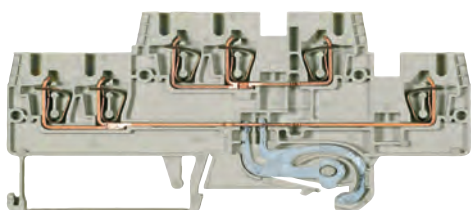

Description	Type	Part No.	Std. Pack
Multi-tier block, combined, gray	WKFN 2,5 E1/2/D/SL/35	56.703.6155.0	50
Multi-tier block, combined, gray	WKFN 2,5 E1/2/N/SL/35	56.703.6455.0	50
<b>General data</b>			
Width / length / height, incl. TS 7.5	5 mm / 107 mm / 48 mm		
Wire strip length	11 mm		
Approvals			
<b>Technical data</b>	<b>IEC</b>	<b>UL</b>	<b>CSA</b>
	EN 60 947-7-1		
Cross section fine-stranded	0.13–2.5 mm <sup>2</sup>		
Cross section solid/stranded	0.13–4 mm <sup>2</sup>		
Cross section, AWG		22–12	24–12
Rated current	22 A	20 A	24 A
Rated voltage	500 V	300 V	300 V
Rated impulse voltage	6 kV		
Pollution degree	3		

**WKFN 2,5 E1/2/35** Block color: gray

	Function	Color ID
Upper tier	Feed-through	gray
Lower tier	Feed-through	gray

**WKFN 2,5 E1/2/D/SL/35** Block color: gray

	Function	Color ID
Upper tier	Feed-through	gray
Lower tier	Ground conductor	green/yellow

**WKFN 2,5 E1/2/N/D/35** Block color: gray

	Function	Color ID
Upper tier	Feed-through	blue
Lower tier	Feed-through	gray

**WKFN 2,5 E1/2/N/SL/35** Block color: gray

	Function	Color ID
Upper tier	Feed-through	blue
Lower tier	Ground conductor	green/yellow

**WKFN 2,5 E1/2/VB/35** Block color: black

	Function	Color ID
Upper tier	Feed-through	black
Lower tier	vert. jumpered	black

**WKFN 2,5 E1/2/SL/35** Block color: green/yellow

	Function	Color ID
Upper tier	Ground conductor	green/yellow
Lower tier	vert. jumpered	green/yellow

**Accessories for fasis WKFN 2,5 E1/2/...**









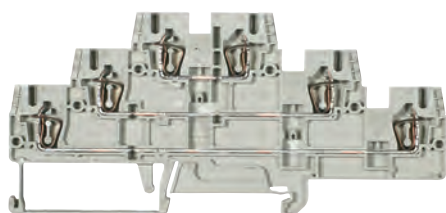

Accessories	Type	Part No.	Std. Pack
End plate	gray APFN 2,5 E1/2	07.312.7755.0	10
Partition	gray TWFN 2,5 E1/2	07.312.7855.0	10
Cross connector, insulated	2 pole IVB WKF 2,5–2	Z7.280.6227.0	10
	3 pole IVB WKF 2,5–3	Z7.280.6327.0	10
	4 pole IVB WKF 2,5–4	Z7.280.6427.0	10
	5 pole IVB WKF 2,5–5	Z7.280.6527.0	10
	10 pole IVB WKF 2,5–10	Z7.280.7027.0	20
	20 pole IVB WKF 2,5–20	Z7.280.8027.0	20
Vertical cross connector	1 pole IVB WKF–V	Z7.261.1127.0	10
Wire entry guide	0.13–0.2 mm <sup>2</sup> LELN 2,5/1 WEISS	05.564.3755.0	100
	0.25–0.5 mm <sup>2</sup> LELN 2,5/2 GRAU	05.564.3855.0	100
	0.75–1.0 mm <sup>2</sup> LELN 2,5/3 SCHWARZ	05.564.3955.0	100
Cover with warning symbol over 4 blocks	yellow ADFN 2,5/4 GELB	04.343.8353.8	10
Marking tag carrier, 2-fold	BT 5/2	04.243.0855.0	100
Test adapter, modular	PS WKC/F	Z1.299.9753.0	10
Test plug	ST 2/2,3	Z5.553.2921.0	10
Screwdriver, uninsulated	DIN 5264 B 0,6x3,5	06.502.4000.0	5
Screwdriver, uninsulated, MINI	DIN 5264 B 0,6x3,5 M	06.502.5000.0	10

## Multi-tier terminal blocks with tension spring connection

### WKFN 2,5 E3/35

- Multi-tier block with tension spring connection for mounting on TS 35
- Nominal cross section 2.5 mm<sup>2</sup>
- Ex e I/II  II 2GD IM2  
Follow the EX installation instructions on page 149







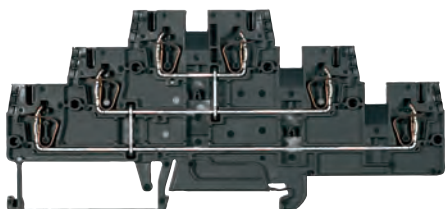

Description	Type	Part No.	Std. Pack
Multi-tier block, gray	WKFN 2,5 E3/35	56.703.3055.0	50
<b>General data</b>			
Width / length / height, incl. TS 7.5	5 mm / 123 mm / 59 mm		
Wire strip length	11 mm		
Approvals	PTB        PTB 04 ATEX 1051 U		
<b>Technical data</b>			
	<b>IEC</b>	<b>UL</b>	<b>CSA</b>
	EN 60 947-7-1		EN 60 079-0/-7
Cross section fine-stranded	0.13–2.5 mm <sup>2</sup>		0.2–2.5 mm <sup>2</sup>
Cross section solid/stranded	0.13–4 mm <sup>2</sup>		0.13–4 mm <sup>2</sup>
Cross section, AWG	22–12		24–12
Rated current	20 A	20 A	24 A
Rated voltage	500 V	300 V	300 V
Rated impulse voltage	6 kV		
Pollution degree	3		
<b>Note</b>	<sup>1)</sup> 1. value at 40 K / 2. value at 45 K <sup>2)</sup> When using cross connectors on the upper tier		

### WKFN 2,5 E3/VB/35

- Multi-tier block, vertically connected, with tension spring connection for mounting on TS 35
- Nominal cross section 2.5 mm<sup>2</sup>
- Ex e I/II  II 2GD IM2  
Follow the EX installation instructions on page 149







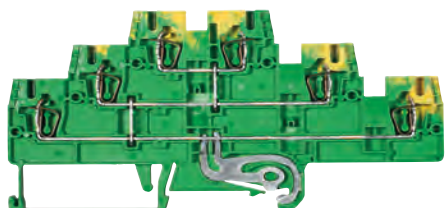

Description	Type	Part No.	Std. Pack
Multi-tier block, black	WKFN 2,5 E3/VB/35	56.703.2955.1	50
<b>General data</b>			
Width / length / height, incl. TS 7.5	5 mm / 123 mm / 59 mm		
Wire strip length	11 mm		
Approvals	PTB        PTB 04 ATEX 1051 U		
<b>Technical data</b>			
	<b>IEC</b>	<b>UL</b>	<b>CSA</b>
	EN 60 947-7-1		EN 60 079-0/-7
Cross section fine-stranded	0.13–2.5 mm <sup>2</sup>		0.2–2.5 mm <sup>2</sup>
Cross section solid/stranded	0.13–4 mm <sup>2</sup>		0.13–4 mm <sup>2</sup>
Cross section, AWG	22–12		24–12
Rated current	20 A	20 A	24 A
Rated voltage	500 V	600 V	600 V
Rated impulse voltage	6 kV		
Pollution degree	3		
<b>Note</b>	<sup>1)</sup> 1. value at 40 K / 2. value at 45 K		

### WKFN 2,5 E3/SL/35

- Multi-tier ground block with tension spring connection for mounting on TS 35
- Nominal cross section 2.5 mm<sup>2</sup>
- Ex e I/II  II 2GD IM2  
Follow the EX installation instructions on page 149



Description	Type	Part No.	Std. Pack
Multi-tier ground block, green/yellow	WKFN 2,5 E/SL/35	56.703.8855.0	50
<b>General data</b>			
Width / length / height, incl. TS 7.5	5 mm / 123 mm / 59 mm		
Wire strip length	11 mm		
Approvals	PTB        PTB 04 ATEX 1051 U		
<b>Technical data</b>			
	<b>IEC</b>	<b>UL</b>	<b>CSA</b>
	EN 60 947-7-2		EN 60 079-0/-7
Cross section fine-stranded	0.13–2.5 mm <sup>2</sup>		0.2–2.5 mm <sup>2</sup>
Cross section solid/stranded	0.13–4 mm <sup>2</sup>		0.13–4 mm <sup>2</sup>
Cross section, AWG	22–12		24–12
Rated current			
Rated voltage	500 V	600 V	600 V
Rated impulse voltage	6 kV		
Pollution degree	3		



## Multi-tier/Motor connection block with tension spring connection

**WKFN 2,5 E3/D/D/SL/35**  
**WKFN 2,5 E3/N/D/SL/35**

- Multi-tier block, combined, with tension spring connection for mounting on TS 35
- Nominal cross section 2.5 mm<sup>2</sup>

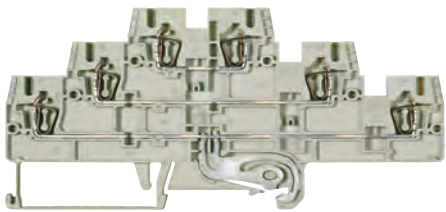

Description	Type	Part No.	Std. Pack
Multi-tier block, gray	WKFN 2,5 E3/D/D/SL/35	56.703.3355.0	50
Multi-tier block, gray	WKFN 2,5 E3/N/D/SL/35	56.703.3255.0	50

General data				
Width / length / height, incl. TS 7.5	5 mm / 123 mm / 59 mm			
Wire strip length	11 mm			
Approvals				
Technical data		IEC	UL	CSA
	EN 60 947-7-1			
Cross section fine-stranded	0.13–2.5 mm <sup>2</sup>			
Cross section solid/stranded	0.13–4 mm <sup>2</sup>			
Cross section, AWG		22–12	24–12	
Rated current	20 A	20 A	24 A	
Rated voltage	500 V	300 V	300 V	
Rated impulse voltage	6 kV			
Pollution degree	3			

**WKFN 2,5 E3/N/D/SL/35** Block color: gray

	Function	Color ID
Upper tier	Feed-through	blue
Center tier	Feed-through	gray
Lower tier	Ground conductor	green/yellow

**WKFN 2,5 E3/D/D/SL/35** Block color: gray

	Function	Color ID
Upper tier	Feed-through	gray
Center tier	Feed-through	gray
Lower tier	Ground conductor	green/yellow

**WKF 4 3D/SL**

- Motor connection block with tension spring connection for mounting on TS 35
- Nominal cross section 4 mm<sup>2</sup>



Description	Type	Part No.	Std. Pack
Motor connection block, gray	WKF 4 3D/SL	56.704.8453.0	50

General data				
Width / length / height, incl. TS 7.5	6 mm / 100 mm / 84 mm			
Wire strip length	10 mm			
Approvals				
Technical data		IEC	UL	CSA
	EN 60947-7-1/DIN VDE 0611 T1			
Cross section fine-stranded	0.13 – 4 mm <sup>2</sup>			
Cross section solid/stranded	0.13 – 4 mm <sup>2</sup>			
Cross section, AWG		28–10	28–10	
Rated current	28 A	30 A	30 A	
Rated voltage	800 V	600 V	600 V	
Rated impulse voltage	8 kV			
Pollution degree	3			

## Accessories for *fasis* WKFN 2,5 E3/...

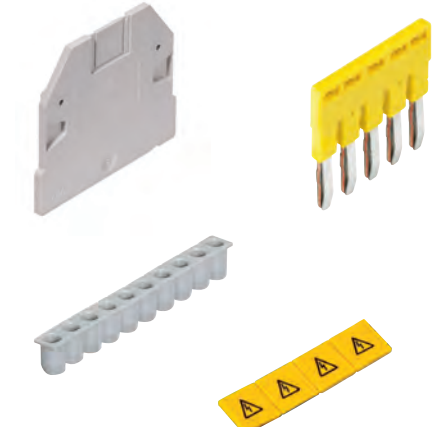

Accessories	Type	Part No.	Std. Pack
End plate	gray APFN 2,5 E3	07.312.7555.0	10
Partition	gray TWFN 2,5 E3	07.312.7655.0	10
Cross connector, insulated	2 pole	IVB WKF 2,5–2	Z7.280.6227.0
	3 pole	IVB WKF 2,5–3	Z7.280.6327.0
	4 pole	IVB WKF 2,5–4	Z7.280.6427.0
	5 pole	IVB WKF 2,5–5	Z7.280.6527.0
	10 pole	IVB WKF 2,5–10	Z7.280.7027.0
	20 pole	IVB WKF 2,5–20	Z7.280.8027.0
Vertical cross connector	1 pole	IVB WKF–V	Z7.261.1127.0
Wire entry guide	0.13–0.2 mm <sup>2</sup>	LELN 2,5/1 WEISS	05.564.3755.0
	0.25–0.5 mm <sup>2</sup>	LELN 2,5/2 GRAU	05.564.3855.0
	0.75–1.0 mm <sup>2</sup>	LELN 2,5/3 SCHWARZ	05.564.3955.0
Cover with warning symbol over 4 blocks	yellow	ADFN 2,5/4 GELB	04.343.8353.8
Marking tag carrier, 2-fold		BT 5/2	04.243.0855.0

# Multi-tier terminal blocks with tension spring connection

## WKFN 4 E/35

### WKFN 4 E/N/D/35

- Multi-tier block with tension spring connection for mounting on TS 35
- Nominal cross section 4 mm<sup>2</sup>
- Ex e I/II II 2GD IM2  
Follow the EX installation instructions on page 149

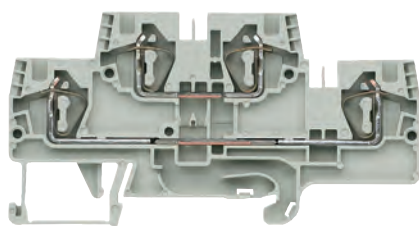

Description	Type	Part No.	Std. Pack
Multi-tier block, gray	WKFN 4 E/35	56.704.7055.0	100
Multi-tier block, combined, gray	WKFN 4 E/N/D/35	56.704.7655.0	100

General data				
Width / length / height, incl. TS 7.5	6 mm / 90 mm / 48 mm			
Wire strip length	11 mm			
Approvals	PTB      PTB 05 ATEX 1104 U			
Technical data	IEC	UL	CSA	
	EN 60 947-7-1			EN 60 079-0/-7
Cross section fine-stranded	0.13–4 mm <sup>2</sup>			0.13–4 mm <sup>2</sup>
Cross section solid/stranded	0.13–6 mm <sup>2</sup>			0.2–6 mm <sup>2</sup>
Cross section, AWG		24–10	24–10	
Rated current	32 A	30 A	32 A	27/29 A <sup>1)2)</sup>
Rated voltage	500 V	300 V	300 V	440/352 V <sup>3)</sup>
Rated impulse voltage	6 kV			
Pollution degree	3			
<b>Note</b>	<sup>1)</sup> 1. value at 40 K / 2. value at 45 K <sup>2)</sup> When cross connectors are used acc. to EN 60079-0 and EN60079-7 the current must be reduced to 2 A at 45 K. <sup>3)</sup> When using cross connectors on the upper tier			

**WKFN 4 E/N/D/35** Block color: gray

	Function	Color ID
Upper tier	Feed-through	blue
Lower tier	Feed-through	gray

## WKFN 4 E/VB/35

- Multi-tier block, vertically connected, with tension spring connection for mounting on TS 35
- Nominal cross section 4 mm<sup>2</sup>
- Ex e I/II II 2GD IM2  
Follow the EX installation instructions on page 149

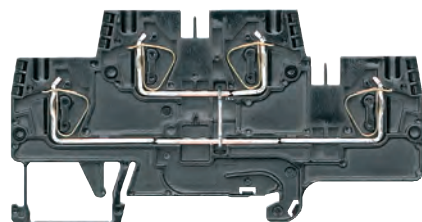

Description	Type	Part No.	Std. Pack
Multi-tier block, black	WKFN 4 E/VB/35	56.704.6955.1	100

General data				
Width / length / height, incl. TS 7.5	6 mm / 90 mm / 48 mm			
Wire strip length	11 mm			
Approvals	PTB      PTB 05 ATEX 1104 U			
Technical data	IEC	UL	CSA	
	EN 60 947-7-1			EN 60 079-0/-7
Cross section fine-stranded	0.13–4 mm <sup>2</sup>			0.13–4 mm <sup>2</sup>
Cross section solid/stranded	0.13–6 mm <sup>2</sup>			0.2–6 mm <sup>2</sup>
Cross section, AWG		24–10	24–10	
Rated current	32 A	30 A	32 A	30/31 A <sup>1)</sup>
Rated voltage	500 V	600 V	300 V	440 V
Rated impulse voltage	6 kV			
Pollution degree	3			
<b>Note</b>	<sup>1)</sup> 1. value at 40 K / 2. value at 45 K			

## WKFN 4 E/SL/35

- Multi-tier ground block with tension spring connection for mounting on TS 35
- Nominal cross section 4 mm<sup>2</sup>
- Ex e I/II II 2GD IM2  
Follow the EX installation instructions on page 149

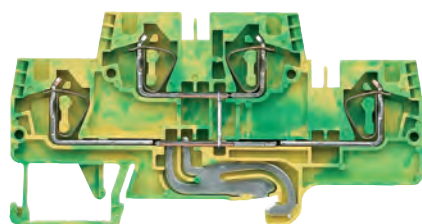

Description	Type	Part No.	Std. Pack
Multi-tier ground block, green/yellow	WKFN 4 E SL/35	56.704.9255.0	100

General data				
Width / length / height, incl. TS 7.5	6 mm / 90 mm / 48 mm			
Wire strip length	11 mm			
Approvals	PTB      PTB 05 ATEX 1104 U			
Technical data	IEC	UL	CSA	
	EN 60 947-7-2			EN 60 079-0/-7
Cross section fine-stranded	0.13–4 mm <sup>2</sup>			0.13–4 mm <sup>2</sup>
Cross section solid/stranded	0.13–6 mm <sup>2</sup>			0.2–6 mm <sup>2</sup>
Cross section, AWG		24–10	24–10	
Rated current				
Rated voltage	500 V	600 V	600 V	
Rated impulse voltage	6 kV			
Pollution degree	3			

## Multi-tier terminal blocks with tension spring connection

**WKFN 4 E/D/SL/35**  
**WKFN 4 E/N/SL/35**

- Multi-tier block, combined, with tension spring connection for mounting on TS 35
- Nominal cross section 4 mm<sup>2</sup>
- Ex e I/II II 2GD IM2  
Follow the EX installation instructions on page 149

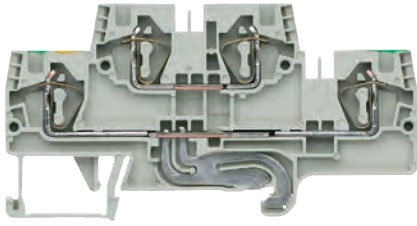

Description	Type	Part No.	Std. Pack
Multi-tier block, combined, gray	WKFN 4 E/D/SL/35	56.704.7855.0	100
Multi-tier block, combined, gray	WKFN 4 E/N/SL/35	56.704.7755.0	100

General data				
Width / length / height, incl. TS 7.5	6 mm / 90 mm / 48 mm			
Wire strip length	11 mm			
Approvals				
Technical data		IEC	UL	CSA
EN 60 947-7-1				
Cross section fine-stranded	0.13–4 mm <sup>2</sup>			
Cross section solid/stranded	0.13–6 mm <sup>2</sup>			
Cross section, AWG		24–10	24–10	
Rated current	32 A	30 A	32 A	
Rated voltage	500 V	300 V	300 V	
Rated impulse voltage	6 kV			
Pollution degree	3			

**WKFN 4 E/D/SL/35** Block color: gray

	Function	Color ID
Upper tier	Feed-through	gray
Lower tier	Ground conductor	green/yellow

**WKFN 4 E/N/SL/35** Block color: gray

	Function	Color ID
Upper tier	Feed-through	blue
Lower tier	Ground conductor	green/yellow

**WKFN 4 E /35...**

- Multi-tier function block with tension spring connection for mounting on TS 35
- Nominal cross section 4 mm<sup>2</sup>

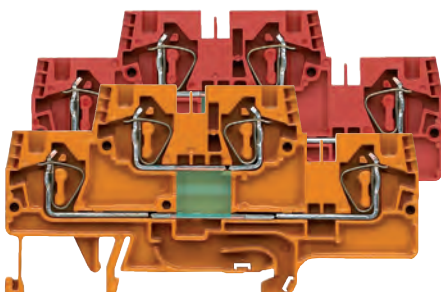

Description	Type	Part No.	Std. Pack
Multi-tier function block, red	WKFN 4 E /35...	56.704.XX55.5	100
Multi-tier function block, orange	WKFN 4 E /35...	56.704.XX55.9	100

General data				
Width / length / height, incl. TS 7.5	6 mm / 90 mm / 48 mm			
Wire strip length	11 mm			
Approvals				
Technical data		IEC	UL	CSA
EN 60947-7-1				
Cross section fine-stranded	0.13 – 4 mm <sup>2</sup>			
Cross section solid/stranded	0.13 – 6 mm <sup>2</sup>			
Cross section, AWG		24–10	24–10	

**Function diagram for fasis WKFN 4 E/...**

The multi-tier block is available on request as a function block for a wide variety of switching tasks.

56.704.7555.9  
56.704.7555.5

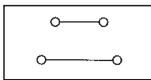

56.704.8255.5

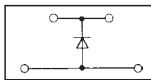

I = 1 A  
U = 1000 V

56.704.7455.9

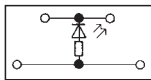

R = 4.7 kΩ  
P = 0.5 W  
U = 24 V DC

56.704.7155.5  
56.704.7155.9

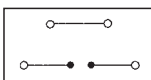

56.704.7955.5

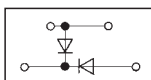

I = 1 A  
U = 1000 V

56.704.7255.5

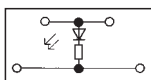

R = 4.7 kΩ  
P = 0.5 W  
U = 24 V DC

56.704.8055.9

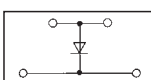

I = 1 A  
U = 1000 V

56.704.8355.5

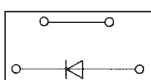

I = 1 A  
U = 1000 V

56.704.7355.5

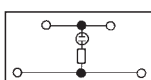

R = 680 kΩ  
P = 0.25 W  
U = 100-500 V

## Accessories for fasis WKFN 4 E/...

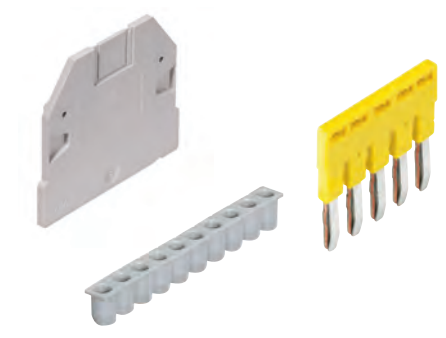

Accessories	Type	Part No.	Std. Pack
End plate	gray APFN 4 E...	07.312.9655.0	10
Partition	gray TWFN 4 E...	07.312.9755.0	10
Cross connector, insulated	2 pole IVB WKF 4-2	Z7.261.1227.0	10
	3 pole IVB WKF 4-3	Z7.261.1327.0	10
	4 pole IVB WKF 4-4	Z7.261.1427.0	10
	5 pole IVB WKF 4-5	Z7.261.1527.0	10
	6 pole IVB WKF 4-6	Z7.261.1627.0	10
	7 pole IVB WKF 4-7	Z7.261.1727.0	20
	8 pole IVB WKF 4-8	Z7.261.1827.0	20
	9 pole IVB WKF 4-9	Z7.261.1927.0	20
	10 pole IVB WKF 4-10	Z7.261.2027.0	20
Vertical cross connector, insulated	1 pole IVB WKF-V	Z7.261.1127.0	10
Wire entry guide	0.13–0.2 mm <sup>2</sup> LEL 4/1 WEISS	05.561.8553.0	100
	0.25–0.5 mm <sup>2</sup> LEL 4/2 GRAU	05.561.8653.0	100
	0.75–1.0 mm <sup>2</sup> LEL 4/3 SCHWARZ	05.561.8753.0	100

## Disconnect terminal blocks with tension spring connection

### WKFN 2,5 TKM/35

- Disconnect terminal block with tension spring connection for mounting on TS 35
- Nominal cross section 2.5 mm<sup>2</sup>

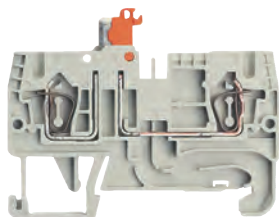

Description	Type	Part No.	Std. Pack
Disconnect terminal block, gray	WKFN 2,5 TKM/35	56.703.5355.0	100
<b>General data</b>			
Width / length / height, incl. TS 7.5	5 mm / 60 mm / 38 mm		
Wire strip length	11 mm		
Approvals			
<b>Technical data</b>	<b>IEC</b>	<b>UL</b>	<b>CSA</b>
	EN 60947-7-1		
Cross section fine-stranded	0.14 – 2.5 mm <sup>2</sup>		
Cross section solid/stranded	0.2 – 4 mm <sup>2</sup>		
Cross section, AWG		24–12	24–12
Rated current	20 A	19 A	20 A
Rated voltage	630 V	300 V	300 V
Rated impulse voltage	6 kV		
Pollution degree	3		
<b>Accessories</b>			
End plate, gray	APFN 2,5 D1/2	07.312.6955.0	10
Partition, gray	TWFN 2,5 D1/2	07.312.7055.0	10

### WKFN 2,5 TKM 1/2/35

- Duo disconnect terminal block with tension spring connection for mounting on TS 35
- Nominal cross section 2.5 mm<sup>2</sup>

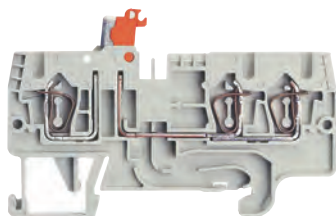

Description	Type	Part No.	Std. Pack
Disconnect terminal block, gray	WKFN 2,5 TKM 1/2/35	56.703.5455.0	100
<b>General data</b>			
Width / length / height, incl. TS 7.5	5 mm / 72 mm / 38 mm		
Wire strip length	11 mm		
Approvals			
<b>Technical data</b>	<b>IEC</b>	<b>UL</b>	<b>CSA</b>
	EN 60947-7-1		
Cross section fine-stranded	0.14 – 2.5 mm <sup>2</sup>		
Cross section solid/stranded	0.2 – 4 mm <sup>2</sup>		
Cross section, AWG		24–12	24–12
Rated current	20 A	19 A	20 A
Rated voltage	630 V	300 V	300 V
Rated impulse voltage	6 kV		
Pollution degree	3		
<b>Accessories</b>			
End plate, gray	APFN 2,5 D2/2	07.312.7155.0	10
Partition, gray	TWFN 2,5 D2/2	07.312.7255.0	10

### WKFN 2,5 TKM 2/2/35

- Duo disconnect terminal block with tension spring connection for mounting on TS 35
- Nominal cross section 2.5 mm<sup>2</sup>

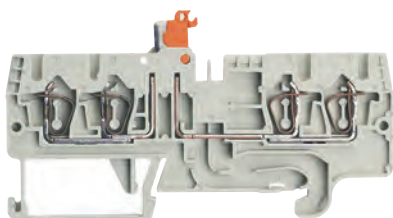



Description	Type	Part No.	Std. Pack
Disconnect terminal block, gray	WKFN 2,5 TKM 2/2/35	56.703.5555.0	100
<b>General data</b>			
Width / length / height, incl. TS 7.5	5 mm / 85 mm / 38 mm		
Wire strip length	11 mm		
Approvals			
<b>Technical data</b>	<b>IEC</b>	<b>UL</b>	<b>CSA</b>
	EN 60947-7-1		
Cross section fine-stranded	0.14 – 2.5 mm <sup>2</sup>		
Cross section solid/stranded	0.2 – 4 mm <sup>2</sup>		
Cross section, AWG		24–12	24–12
Rated current	20 A	19 A	20 A
Rated voltage	630 V	300 V	300 V
Rated impulse voltage	6 kV		
Pollution degree	3		
<b>Accessories</b>			
End plate, gray	APFN 2,5 TKM D2/2	07.313.0055.0	10
Partition, gray	TWFN 2,5 TKM D2/2	07.313.0155.0	10

## Multi-tier disconnect terminal blocks with tension spring connection

### WKFN 2,5 TKM E1/35

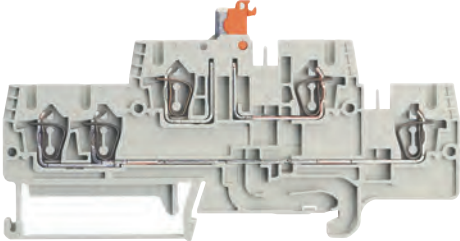
- Multi-tier disconnect terminal block with tension spring connection for mounting on TS 35
- Nominal cross section 2.5 mm<sup>2</sup>



Description	Type	Part No.	Std. Pack
Disconnect terminal block, gray	WKFN 2,5 TKM E1/35	56.703.6555.0	50
<b>General data</b>			
Width / length / height, incl. TS 7.5	5 mm / 107 mm / 48 mm		
Wire strip length	11 mm		
Approvals			
<b>Technical data</b>	<b>IEC</b>	<b>UL</b>	<b>CSA</b>
	EN 60947-7-1		
Cross section fine-stranded	0.14 – 2.5 mm <sup>2</sup>		
Cross section solid/stranded	0.2 – 4 mm <sup>2</sup>		
Cross section, AWG		24 – 12	24 – 12
Rated current	20 A	19 A	20 A
Rated voltage	500 V	300 V	300 V
Rated impulse voltage	6 kV		
Pollution degree	3		
<b>Accessories</b>			
	Type	Part No.	Std. Pack
End plate, gray	APFN 2,5 E1/2	07.312.7755.0	10
Partition, gray	TWFN 2,5 E1/2	07.312.7855.0	10

### WKFN 2,5 TKM E2/35

- Multi-tier disconnect terminal block with tension spring connection for mounting on TS 35
- Nominal cross section 2.5 mm<sup>2</sup>

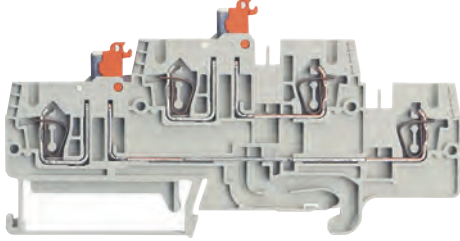

Description	Type	Part No.	Std. Pack
Disconnect terminal block, gray	WKFN 2,5 TKM E2/35	56.703.6555.0	50
<b>General data</b>			
Width / length / height, incl. TS 7.5	5 mm / 107 mm / 48 mm		
Wire strip length	11 mm		
Approvals			
<b>Technical data</b>	<b>IEC</b>	<b>UL</b>	<b>CSA</b>
	EN 60947-7-1		
Cross section fine-stranded	0.14 – 2.5 mm <sup>2</sup>		
Cross section solid/stranded	0.2 – 4 mm <sup>2</sup>		
Cross section, AWG		24 – 12	24 – 12
Rated current	19 A	19 A	19 A
Rated voltage	500 V	300 V	300 V
Rated impulse voltage	6 kV		
Pollution degree	3		
<b>Accessories</b>			
	Type	Part No.	Std. Pack
End plate, gray	APFN 2,5 E1/2	07.312.7755.0	10
Partition, gray	TWFN 2,5 E1/2	07.312.7855.0	10

## Accessories for *fasis* WKFN 2,5 TKM...

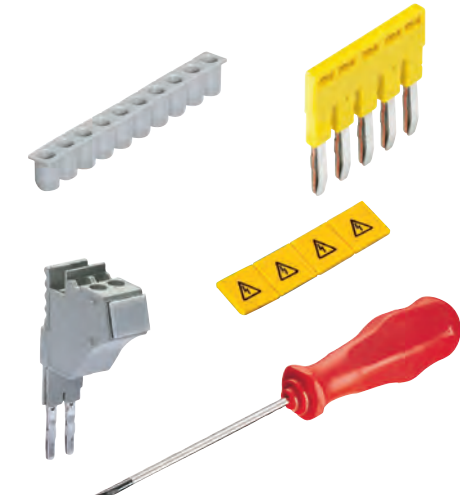

Accessories	Type	Part No.	Std. Pack	
Cross connector, insulated	2 pole	IVB WKF 2,5–2	Z7.280.6227.0	10
	3 pole	IVB WKF 2,5–3	Z7.280.6327.0	10
	4 pole	IVB WKF 2,5–4	Z7.280.6427.0	10
	5 pole	IVB WKF 2,5–5	Z7.280.6527.0	10
	6 pole	IVB WKF 2,5–6	Z7.280.6627.0	10
	7 pole	IVB WKF 2,5–7	Z7.280.6727.0	20
	8 pole	IVB WKF 2,5–8	Z7.280.6827.0	20
	9 pole	IVB WKF 2,5–9	Z7.280.6927.0	20
	10 pole	IVB WKF 2,5–10	Z7.280.7027.0	20
	20 pole	IVB WKF 2,5–20	Z7.280.8027.0	20
Wire entry guide	0.13–0.2 mm <sup>2</sup>	LELN 2,5/1 WEISS	05.564.3755.0	100
	0.25–0.5 mm <sup>2</sup>	LELN 2,5/2 GRAU	05.564.3855.0	100
	0.75–1.0 mm <sup>2</sup>	LELN 2,5/3 SCHWARZ	05.564.3955.0	100
Cover with warning symbol over 4 blocks	yellow	ADFN 2,5/4 GELB	04.343.8353.8	10
Test adapter, modular	PS WKC/F	Z1.299.9753.0	10	
Test plug	ST 2/2,3	Z5.553.2921.0	10	
Screwdriver, uninsulated	DIN 5264 B 0,6x3,5	06.502.4000.0	5	
Screwdriver, uninsulated, MINI	DIN 5264 B 0,6x3,5 M	06.502.5000.0	10	

## Fuse blocks with tension spring connection

### WKFN 4 TKG with THSi 5 x 20

- Disconnect block with tension spring connection for mounting on TS 35
- Nominal cross section 4 mm<sup>2</sup>

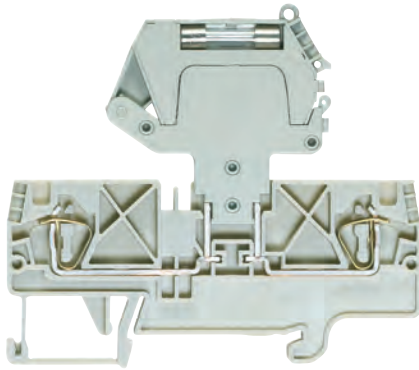

Description	Type	Part No.	Std. Pack
Disconnect block, gray	WKFN 4 TKG/35	56.704.4055.0	100
Fuse disconnect lever	THSi 5x20	Z1.298.1053.0	10
Fuse disconnect lever with LED 12–24 V <sup>2)</sup>	THSi 5x20 LED24	Z1.298.1153.0	10
Fuse disconnect lever with LED 24–60 V <sup>2)</sup>	THSi 5x20 LED60	Z1.298.1253.0	10
Fuse disconnect lever with GL 110–250 V <sup>2)</sup>	THSi 5x20 GL250	Z1.298.1353.0	10

General data				
Width / length / height, incl. TS 7.5	6 mm / 82 mm / 38 mm			
Wire strip length	11 mm			
Approvals				
Technical data		IEC	UL	CSA
		EN 60 947-7-3		
Cross section fine-stranded	0.13–4 mm <sup>2</sup>			
Cross section solid/stranded	0.13–6 mm <sup>2</sup>			
Cross section, AWG		24–10	22–10	
Rated current	1)	1)	10 A <sup>1)</sup>	
Rated voltage	500 V <sup>2)</sup>	600 V <sup>2)</sup>	300 V <sup>2)</sup>	
Rated impulse voltage	8 kV			
Pollution degree	3			

Accessories	Type	Part No.	Std. Pack
End plate, gray	APFN 4 D2/2	07.312.9055.0	10
Partition, gray	TWFN 4 D2/2	07.312.9155.0	10

### WKFN 4 TKG with THSi 6,3 x 32

- Disconnect block with tension spring connection for mounting on TS 35
- Nominal cross section 4 mm<sup>2</sup>

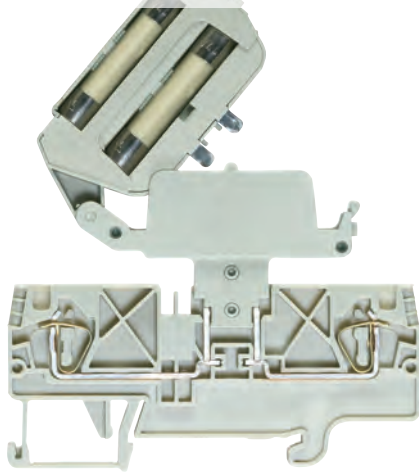

Description	Type	Part No.	Std. Pack
Disconnect block, gray	WKFN 4 TKG/35	56.704.4055.0	100
Fuse disconnect lever	THSi 6,3x32	Z1.298.1653.0	10
Fuse disconnect lever with LED 12–24 V <sup>2)</sup>	THSi 6,3x32 LED24	Z1.298.1753.0	10
Fuse disconnect lever with LED 24–60 V <sup>2)</sup>	THSi 6,3x32 LED60	Z1.298.1853.0	10
Fuse disconnect lever with GL 110–250 V <sup>2)</sup>	THSi 6,3x32 GL250	Z1.298.1953.0	10
Fuse disconnect lever with GL 500 V <sup>2)</sup>	THSi 6,3x32 GL500	Z1.298.2053.0	10

General data				
Width / length / height, incl. TS 7.5	6 mm / 82 mm / 38 mm			
Wire strip length	11 mm			
Approvals				
Technical data		IEC	UL	CSA
		EN 60 947-7-3		
Cross section fine-stranded	0.13–4 mm <sup>2</sup>			
Cross section solid/stranded	0.13–6 mm <sup>2</sup>			
Cross section, AWG		24–10	22–10	
Rated current	1)	1)	10 A <sup>1)</sup>	
Rated voltage	500 V <sup>2)</sup>	600 V <sup>2)</sup>	300 V <sup>2)</sup>	
Rated impulse voltage	8 kV			
Pollution degree	3			

Accessories	Type	Part No.	Std. Pack
End plate, gray	APFN 4 D2/2	07.312.9055.0	10
Intermediate plate, 4 mm, gray	ZP/WKFN 4 TKG	07.313.1655.0	10
Partition, gray	TWFN 4 D2/2	07.312.9155.0	10

## Info and accessories for fasis WKFN 4 TKG with THSi...

<sup>1)</sup> The current is determined by the inserted fuse.

<sup>2)</sup> The voltage range is determined by the built-in LED display. Depending on the application and the installation method, the circumstances for increased temperature must be checked in the closed fuse holders.

Higher ambient temperatures are an additional load for the fuse inserts. Therefore, the reduction of the rated current must be considered accordingly in these applications.

Indicator (24 V): LED, red  
current consumption: 10.3 mA

Indicator (220 V): LED, red  
current consumption: 0.3 mA

When selecting G fuse inserts, make sure that the specified maximum power is not exceeded.  
Maximum power loss at 23°C ambient temperature (according to DIN EN 60947-7-3)

Type	Rated voltage	Overload protection		Exclusive short-circuit protection	
		Single arrangement	Group arrangement	Single arrangement	Group arrangement
THSi 5x20	250 V	1.6 W	1.6 W	4.0 W	2.5 W
THSi 6,3x32	500 V	2.5 W	1.6 W	4.0 W	2.5 W

Accessories	Type	Part No.	Std. Pack	
Cross connector, insulated	2 pole IVB WKF 4-2	Z7.261.1227.0	10	
for WKFN 4 TKG with THSi 5x20	3 pole IVB WKF 4-3	Z7.261.1327.0	10	
	4 pole IVB WKF 4-4	Z7.261.1427.0	10	
	5 pole IVB WKF 4-5	Z7.261.1527.0	10	
	6 pole IVB WKF 4-6	Z7.261.1627.0	10	
	7 pole IVB WKF 4-7	Z7.261.1727.0	20	
	8 pole IVB WKF 4-8	Z7.261.1827.0	20	
	9 pole IVB WKF 4-9	Z7.261.1927.0	20	
	10 pole IVB WKF 4-10	Z7.261.2027.0	20	
	Wire entry guide	0.13–0.2 mm <sup>2</sup> LEL 4/1 WEISS	05.561.8553.0	100
		0.25–0.5 mm <sup>2</sup> LEL 4/2 GRAU	05.561.8653.0	100
0.75–1.0 mm <sup>2</sup> LEL 4/3 SCHWARZ		05.561.8753.0	100	
Cover with warning symbol over 4 blocks	yellow ADF 4/4 GELB	04.343.6153.8	10	
Test adapter, modular	ST 2/2,3	Z5.553.2921.0	10	
Screwdriver, uninsulated	DIN 5264 B 0,6x3,5	06.502.4000.0	5	
Screwdriver, uninsulated, MINI	DIN 5264 B 0,6x3,5 M	06.502.5000.0	10	

For WKFN 4 TKG with THSi 6.3x32 and intermediate plate cross connector IVB WKF 2,5-x must be used.

### WKFN 4 TKG with SiST

- Disconnect block with tension spring connection for mounting on TS 35
- Nominal cross section 4 mm<sup>2</sup>

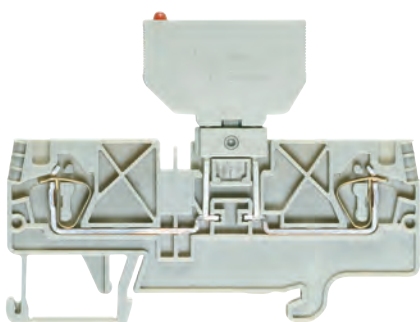

Description	Type	Part No.	Std. Pack
Disconnect block, gray	WKFN 4 TKG/35	56.704.4055.0	100
Fuse holder for fuse 5 x 20	Si ST	Z1.299.4055.0	10
Fuse holder with indicator (24V) <sup>2)</sup>	Si ST LED	Z1.299.4155.0	10
Fuse holder with indicator (220V) <sup>2)</sup>	Si ST GL	Z1.299.4255.0	10

General data				
Width / length / height, incl. TS 7.5	6 mm / 82 mm / 38 mm			
Wire strip length	11 mm			
Approvals				
Technical data		IEC	UL	CSA
		EN 60 947-7-3		
Cross section fine-stranded	0.13–4 mm <sup>2</sup>			
Cross section solid/stranded	0.13–6 mm <sup>2</sup>			
Cross section, AWG	24–10			
Rated current	1)	24–10	22–10	
Rated voltage	500 V <sup>2)</sup>	600 V <sup>2)</sup>	300 V <sup>2)</sup>	
Rated impulse voltage	8 kV			
Pollution degree	3			

Accessories		Type	Part No.	Std. Pack
End plate, gray		APFN 4 D2/2	07.312.9055.0	10
Partition, gray		TWFN 4 D2/2	07.312.9155.0	10

### WKFN 4 TKG with DiST

- Disconnect block with tension spring connection for mounting on TS 35
- Nominal cross section 4 mm<sup>2</sup>

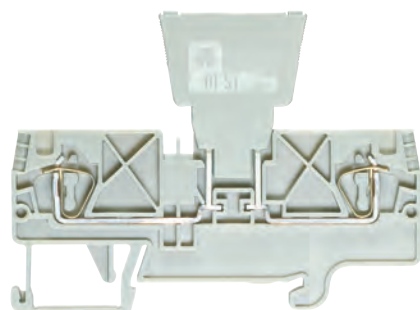

Description	Type	Part No.	Std. Pack
Disconnect block, gray	WKFN 4 TKG/35	56.704.4055.0	100
Diode plug – empty	J <sub>max</sub> = 10 A <sup>1)</sup> DIST ...	Z1.299.3055.0	10
Diode plug – diode	J <sub>max</sub> = 1 A <sup>1)</sup> DIST-1 N 4007-1 <sup>3)</sup>	Z1.299.3155.0	10
Diode plug – diode	J <sub>max</sub> = 1 A <sup>1)</sup> DIST-1 N 4007-2 <sup>4)</sup>	Z1.299.3355.0	10
Diode plug with jumper	J <sub>max</sub> = 10 A <sup>1)</sup> DIST-D	Z1.299.3255.0	10

General data				
Width / length / height, incl. TS 7.5	6 mm / 82 mm / 38 mm			
Wire strip length	11 mm			
Approvals				
Technical data		IEC	UL	CSA
		EN 60 947-7-3		
Cross section fine-stranded	0.13–4 mm <sup>2</sup>			
Cross section solid/stranded	0.13–6 mm <sup>2</sup>			
Cross section, AWG	24–10			
Rated current	1)	24–10	22–10	
Rated voltage	500 V <sup>2)</sup>	600 V <sup>2)</sup>	300 V <sup>2)</sup>	
Rated impulse voltage	8 kV			
Pollution degree	3			

Accessories		Type	Part No.	Std. Pack
End plate, gray		APFN 4 D2/2	07.312.9055.0	10
Partition, gray		TWFN 4 D2/2	07.312.9155.0	10

## Info and Accessories for fasis WKFN 4 TKG with SiST and DiST

- <sup>1)</sup> The current is determined by the inserted fuse.  
<sup>2)</sup> The voltage range is determined by the built-in LED display. Depending on the application and the installation method, the circumstances for increased temperature must be checked in the closed fuse holders.  
 Higher ambient temperatures are an additional load for the fuse inserts. Therefore, the reduction of the rated current must be considered accordingly in these applications.  
 Indicator (24 V): LED, red  
 current consumption: 10.3 mA  
 Indicator (220 V): LED, red  
 current consumption: 0.3 mA  
<sup>3)/4)</sup> Periodic peak voltage 1000 V  
 Direction of the diode: Anode Cathode<sup>3)</sup>  
 Cathode Anode<sup>4)</sup>

Accessories		Type	Part No.	Std. Pack
Cross connector, insulated	2 pole	IVB WKF 4-2	Z7.261.1227.0	10
	3 pole	IVB WKF 4-3	Z7.261.1327.0	10
	4 pole	IVB WKF 4-4	Z7.261.1427.0	10
	5 pole	IVB WKF 4-5	Z7.261.1527.0	10
	6 pole	IVB WKF 4-6	Z7.261.1627.0	10
	7 pole	IVB WKF 4-7	Z7.261.1727.0	20
	8 pole	IVB WKF 4-8	Z7.261.1827.0	20
	9 pole	IVB WKF 4-9	Z7.261.1927.0	20
	10 pole	IVB WKF 4-10	Z7.261.2027.0	20
	Wire entry guide	0.13–0.2 mm <sup>2</sup>	LEL 4/1 WEISS	05.561.8553.0
0.25–0.5 mm <sup>2</sup>		LEL 4/2 GRAU	05.561.8653.0	100
0.75–1.0 mm <sup>2</sup>		LEL 4/3 SCHWARZ	05.561.8753.0	100
Cover with warning symbol over 4 blocks	yellow	ADF 4/4 GELB	04.343.6153.8	10
Test adapter, modular		ST 2/2,3	Z5.553.2921.0	10
Screwdriver, uninsulated		DIN 5264 B 0,6x3,5	06.502.4000.0	5
Screwdriver, uninsulated, MINI		DIN 5264 B 0,6x3,5 M	06.502.5000.0	10

Type	Rated voltage	Overload protection		Exclusive short-circuit protection	
		Single arrangement	Group arrangement	Single arrangement	Group arrangement
SiST	250V	1.6W	1.6W	2.5W	1.6W

When selecting G fuse inserts, make sure that the specified maximum power is not exceeded.  
 Maximum power loss at 23° C ambient temperature (according to DIN EN 60947-7-3)

## Fuse blocks with tension spring connection

### WKFN 4 FSI

- Fuse block for automobile fuses for mounting on TS 35
- Nominal cross section 4 mm<sup>2</sup>

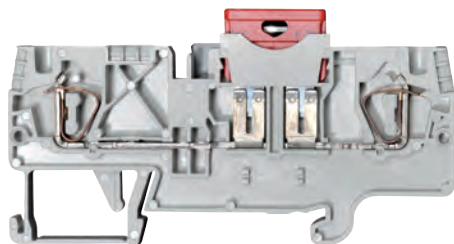

Description	Type	Part No.	Std. Pack
Fuse block, gray	WKFN 4 FSI	56.704.4155.0	100
<b>General data</b>			
Width / length / height, incl. TS 7.5	6 mm / 82 mm / 39 mm		
Wire strip length	12 mm		
Approvals			
<b>Technical data</b>	<b>IEC</b>	<b>UL</b>	<b>CSA</b>
	EN 60947-7-3		
Cross section fine-stranded	0.13 – 4 mm <sup>2</sup>		
Cross section solid/stranded	0.13 – 6 mm <sup>2</sup>		
Cross section, AWG			
Rated current	*		
Rated voltage	800 V		
Rated impulse voltage	8 kV		
Pollution degree	3		
<b>Note</b>	* Observe the derating curve, available in our e-catalog at <a href="https://eshop.wieland-electric.com">https://eshop.wieland-electric.com</a>		
<b>Accessories</b>			
End plate, gray	APFN 4 D2/2	07.312.9055.0	10
Partition, 4 mm for TCP, gray	ZP/WKFN 4 TKG	07.313.1655.0	10
Partition, gray	TWFN 4 D2/2	07.312.9155.0	10

### WKFN 4 FSI

- Fuse block with indicator for mounting on TS 35
- Nominal cross section 4 mm<sup>2</sup>

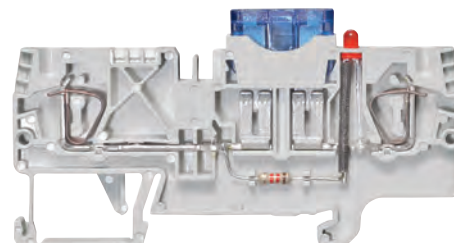

Description	Type	Part No.	Std. Pack
Fuse block, gray	WKFN 4 FSI LED12	56.704.4255.0	100
Fuse block, gray	WKFN 4 FSI LED24	56.704.5355.0	100
<b>General data</b>			
Width / length / height, incl. TS 7.5	6 mm / 82 mm / 39 mm		
Wire strip length	12 mm		
Approvals			
<b>Technical data</b>	<b>IEC</b>	<b>UL</b>	<b>CSA</b>
	EN 60947-7-3		
Cross section fine-stranded	0.13 – 4 mm <sup>2</sup>		
Cross section solid/stranded	0.13 – 6 mm <sup>2</sup>		
Cross section, AWG			
Rated current	*		
Rated voltage	800 V		
Rated impulse voltage	8 kV		
Pollution degree	3		
<b>Note</b>	* Observe the derating curve, available in our e-catalog at <a href="https://eshop.wieland-electric.com">https://eshop.wieland-electric.com</a>		
<b>Accessories</b>			
End plate, gray	APFN 4 D2/2	07.312.9055.0	10
Partition, 4 mm for TCP, gray	ZP/WKFN 4 TKG	07.313.1655.0	10
Partition, gray	TWFN 4 D2/2	07.312.9155.0	10

### Automotive fuses

The WKFN 4 FSI .. type fuse blocks take blade-type fuses according to ISO 8820 (DIN 72581-3).

Automotive fuses are not offered for sale by Wieland Electric!

**We recommend the following:**



Description	Color	
<b>Blade-type automobile fuse, DC 32 V</b>	black	1 A
Electrotechnical specialized trade	gray	2 A
Motor vehicle accessory market	violet	3 A
	pink	4 A
	beige	5 A
	brown	7.5 A
	red	10 A
	blue	15 A
	yellow	20 A
<b>Thermal circuit breaker, DC 32 V</b>		5 A
ETA*, type 1610-21 or		6 A
ETA*, type 1610-H2 with manual release		10 A
		15 A
		20 A
<b>Thermal circuit breaker, AC 250 V; DC 65 V</b>		0.1 A
ETA*, type 1180 ..		0.2 A
		0.5 A
		1 A
		2 A
		3 A
		4 A
		6 A
		8 A
		10 A



## Supply terminal

### WKF 16/35 PV/WKFN

- Supply terminal for mounting on TS 35
- Nominal cross section 16 mm<sup>2</sup>
- Ex e I/II Ⓜ II 2GD IM2  
Follow the EX installation instructions on page 149

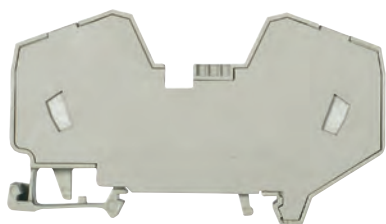

Description	Type	Part No.	Std. Pack			
Supply terminal, gray	WKF 16/35 PV/WKFN	56.716.0353.0	20			
<b>General data</b>						
Width / length / height, incl. TS 7.5	12 mm / 82 mm / 48 mm					
Wire strip length	15 mm					
Approvals	IEC ATEX KEMA 01 ATEX 2087 U					
<b>Technical data</b>		<b>IEC</b>	<b>UL</b>	<b>CSA</b>	<b>Ex</b>	
	EN 60 947-7-3				EN 60 079-0/-7	
Cross section fine-stranded	4–16 mm <sup>2</sup>				4–16 mm <sup>2</sup>	
Cross section solid/stranded	4–16 mm <sup>2</sup>				4–16 mm <sup>2</sup>	
Cross section, AWG		24–4	12–4			
Rated current	76 A	75 A	78 A		64 A <sup>1)</sup>	
Rated voltage	800 V	600 V	600 V		690 V	
Rated impulse voltage	8 kV					
Pollution degree	3					
<b>Note</b>	<sup>1)</sup> Derating curves available on request					
<b>Accessories</b>				Type	Part No.	Std. Pack
Cover with warning symbol over 4 blocks	ADF 16/4 GELB	04.343.6653.8	10			
Screwdriver, uninsulated	DIN 5264 B 1,0x5,5	06.502.4200.0	5			

Potential distribution	one side		both sides	
	single	double	single	double
Jumping				
IVB WKF 4...				
I <sub>max</sub>	64	76	76	76
I <sub>Nblock</sub>	32	32	32	32

$$I_{\max} = \sum I_n \leq \sum I_{N \text{ block}}$$

## Accessories for fasis WKFN 4 FSI...



Accessories	Type	Part No.	Std. Pack	
Cross connector, insulated, for	2 blocks	IVB WKF 4–2	Z7.261.1227.0	10
	3 blocks	IVB WKF 4–3	Z7.261.1327.0	10
	4 blocks	IVB WKF 4–4	Z7.261.1427.0	10
	5 blocks	IVB WKF 4–5	Z7.261.1527.0	10
	6 blocks	IVB WKF 4–6	Z7.261.1627.0	10
	7 blocks	IVB WKF 4–7	Z7.261.1727.0	20
	8 blocks	IVB WKF 4–8	Z7.261.1827.0	20
	9 blocks	IVB WKF 4–9	Z7.261.1927.0	20
	10 blocks	IVB WKF 4–10	Z7.261.1027.0	20
	Wire entry guide	0.13–0.2 mm <sup>2</sup>	LEL 4/1 WEISS	05.561.8553.0
0.25–0.5 mm <sup>2</sup>		LEL 4/2 GRAU	05.561.8653.0	100
0.75–1.0 mm <sup>2</sup>		LEL 4/1 SCHWARZ	05.561.8753.0	100
Cover with warning symbol over 4 blocks	yellow	ADF 4/4 GELB	04.343.6153.8	10
Screwdriver, uninsulated		DIN 5264 B 0,6x3,5	06.502.4000.0	5
Screwdriver, uninsulated, MINI		DIN 5264 B 0,6x3,5 M	06.502.5000.0	10

## DIN rail terminal blocks with plug-in connection

### The system

- Rated current up to 32 A
- Connection cross-section 4 mm<sup>2</sup>
- Width 5 mm

### The terminals

Modular DIN rail mount terminals for universal use with pluggable connectors, all with tension spring connection technology.

In addition to the pluggable connection, a tension spring connection also is available to use the block as a standard feed-through terminal.

### The connectors

For application specific wire harness assemblies, or single pole test plug.

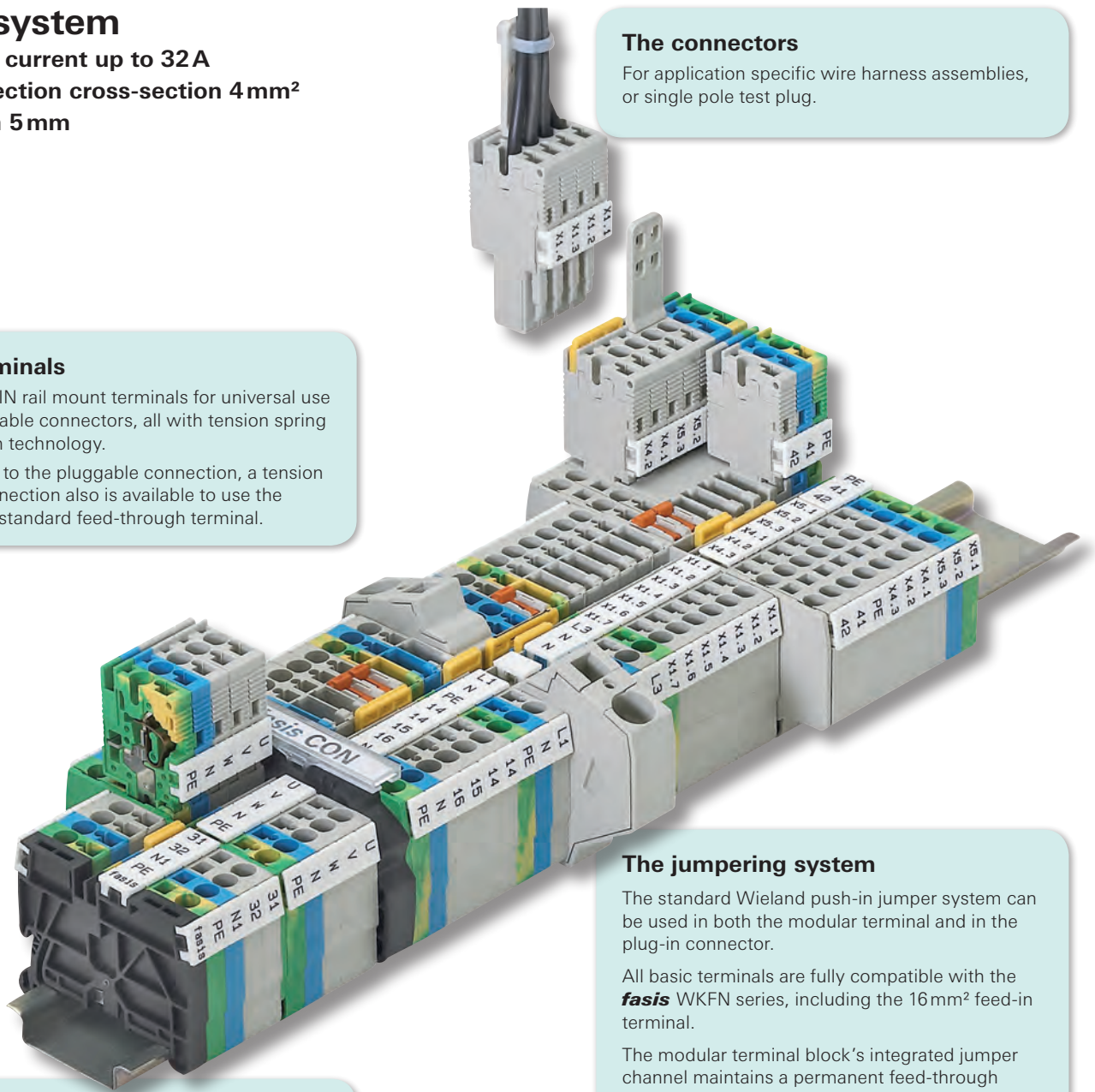

### The labeling system

All termination points can be clearly labeled using the standard Wieland labeling system.

### The jumpering system

The standard Wieland push-in jumper system can be used in both the modular terminal and in the plug-in connector.

All basic terminals are fully compatible with the **fasis** WKFN series, including the 16 mm<sup>2</sup> feed-in terminal.

The modular terminal block's integrated jumper channel maintains a permanent feed-through connection even when the plug is not installed.

### Integrated safety

Touch protection of all components, even when not connected, IP 20 when connected.

All plug connectors have a built-in latching mechanism and coding option – no further accessories required.



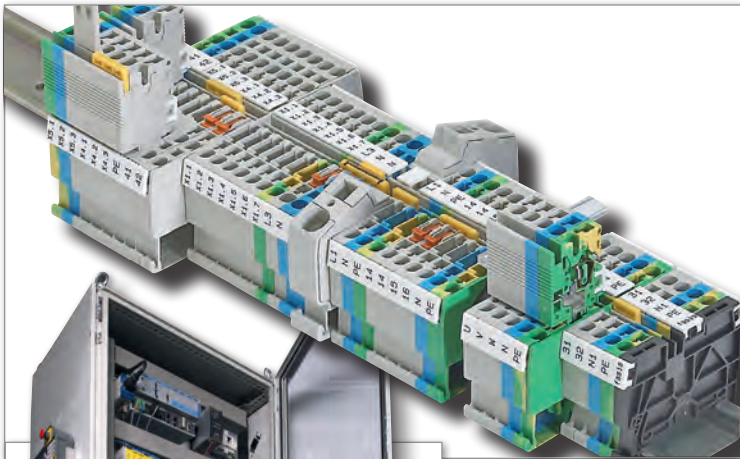

### Plug & Play in the control cabinet – with fasis CON

fasis CON is a DIN rail terminal block system with a pluggable outgoing feeder, which offers modular, cost-saving solutions with advantages in every phase of the service life of an electrical system.

fasis CON is a fully compatible part of the established fasis WKFN system. Both the terminal and the plug connector possess the high-performance features of fasis WKFN.

fasis CON consists of feed-through and ground DIN rail terminal blocks with a wide variety of both wiring termination points and sockets for the fasis CON pluggable connectors.

fasis CON is a cost-effective, high-performance and pluggable system solution.

### Cost-effective

- Cost-optimized installation and maintenance times
- Small numbers of components
- Can be assembled individually
- Pre-assembled modules

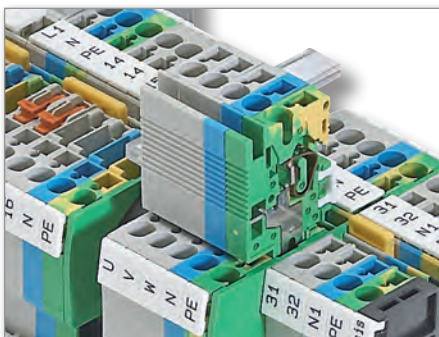

### High-performance

- Range of terminals up to 4 mm<sup>2</sup>
- Rated current up to 32 A\*
- Rated voltage 500 V
- Total width only 5 mm



### Pluggable

- Complex systems can be brought on-line quickly and cost-effectively with pluggable technology
- Functional units can be tested easily
- Field components can be more quickly replaced when faults occur
- Systems can be expanded with pluggable technology

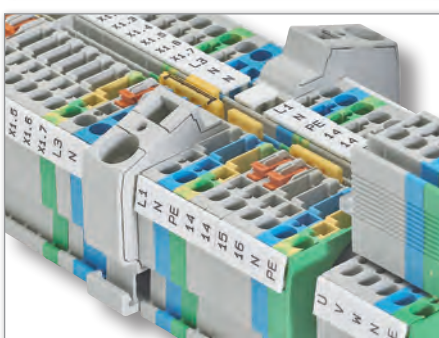

### Complete system

- Uniform accessories
- Coded to prevent mismatching
- All components can be jumpered
- Comprehensive and clear labeling
- Can be combined with fasis WKFN

\* Observe the derating curve, available in our e-catalog at <https://eshop.wieland-electric.com>

## DIN rail terminal blocks with plug-in connection

### WKFN 2,5 F/P/F

- DIN rail terminal blocks with plug-in connection for mounting on TS 35
- Nominal cross section 2.5 mm<sup>2</sup>

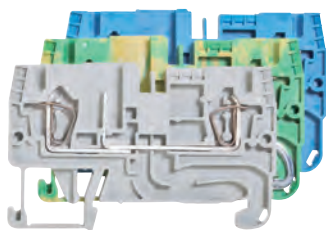

Description	Type	Part No.	Std. Pack
Feed-through block F/P/F, gray	WKFN 2,5 F/P/F	56.703.2355.0	100
Feed-through block F/P/F, blue	WKFN 2,5 F/P/F	56.703.2355.6	100
<b>Ground block</b> , green/yellow	WKFN 2,5 F/P/F-SL	56.703.2455.0	100
<b>General data</b>			
Width / length / height, incl. TS 7.5	5 mm / 60 mm / 39 mm		
Wire strip length	11 mm		
Approvals			
<b>Technical data</b>	<b>IEC</b>	<b>UL</b>	<b>CSA</b>
	EN 60947-7-1/-2		
Cross section fine-stranded	0.13 – 4 mm <sup>2</sup>		
Cross section solid/stranded	0.13 – 4 mm <sup>2</sup>		
Cross section, AWG		24 – 12	24 – 12
Rated current	32 A*	20 A	20 A
Rated voltage	500 V	500 V	500 V
Rated impulse voltage	8 kV		
Pollution degree	3		
<b>Note</b>	* Observe the derating curve, available in our e-catalog at <a href="https://eshop.wieland-electric.com">https://eshop.wieland-electric.com</a>		
<b>Accessories</b>			
End plate, gray	APFN 2,5 D1/2	07.312.6955.0	10
End plate, blue	APFN 2,5 D1/2 BLAU	07.312.6955.6	10
Partition, gray	TWFN 2,5 D1/2	07.312.7055.0	10

### WKFN 2,5 2P/2F

- DIN rail terminal blocks with plug-in connection for mounting on TS 35
- Nominal cross section 2.5 mm<sup>2</sup>



Description	Type	Part No.	Std. Pack
<b>Feed-through block 2P/2F</b> , gray	WKFN 2,5 2P/2F	56.703.2155.0	100
<b>Feed-through block 2P/2F</b> , blue	WKFN 2,5 2P/2F	56.703.2155.6	100
<b>Ground block</b> , green/yellow	WKFN 2,5 2P/2F-SL	56.703.2255.0	100
<b>General data</b>			
Width / length / height, incl. TS 7.5	5 mm / 85 mm / 39 mm		
Wire strip length	11 mm		
Approvals			
<b>Technical data</b>	<b>IEC</b>	<b>UL</b>	<b>CSA</b>
	EN 60947-7-1/-2		
Cross section fine-stranded	0.13 – 4 mm <sup>2</sup>		
Cross section solid/stranded	0.13 – 4 mm <sup>2</sup>		
Cross section, AWG		24 – 12	24 – 12
Rated current	32 A*	20 A	20 A
Rated voltage	500 V	500 V	500 V
Rated impulse voltage	8 kV		
Pollution degree	3		
<b>Note</b>	* Observe the derating curve, available in our e-catalog at <a href="https://eshop.wieland-electric.com">https://eshop.wieland-electric.com</a>		
<b>Accessories</b>			
End plate, gray	APFN 2,5 TKM D2/2	07.313.0055.0	10
Partition, gray	TWFN 2,5 TKM D2/2	07.313.0155.0	10

### WKFN 2,5 E/./././.

- Multi-tier blocks with plug-in connection for mounting on TS 35
- Nominal cross section 2.5 mm<sup>2</sup>

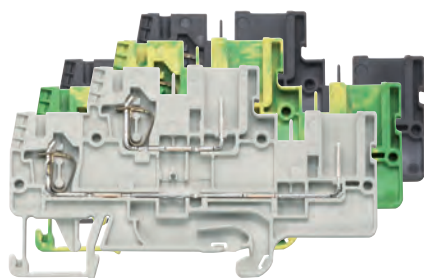

Description	Type	Part No.	Std. Pack
Multi-tier block E/F/P, gray	WKFN 2,5 E/F/P	56.703.3455.0	100
Multi-tier block, vertically connected, black	WKFN 2,5 E/VB/F/P	56.703.3555.1	100
Multi-tier ground block, green/yellow	WKFN 2,5 E/F/P/SL	56.703.3655.0	100
<b>General data</b>			
Width / length / height, incl. TS 7.5	5 mm / 82 mm / 49 mm		
Wire strip length	11 mm		
Approvals			
<b>Technical data</b>	<b>IEC</b>	<b>UL</b>	<b>CSA</b>
	EN 60947-7-1/-2		
Cross section fine-stranded	0.13 – 4 mm <sup>2</sup>		
Cross section solid/stranded	0.13 – 4 mm <sup>2</sup>		
Cross section, AWG		24 – 12	24 – 12
Rated current	22 A*	20 A	20 A
Rated voltage	500 V	500 V	500 V
Rated impulse voltage	8 kV		
Pollution degree	3		
<b>Note</b>	* Observe the derating curve, available in our e-catalog at <a href="https://eshop.wieland-electric.com">https://eshop.wieland-electric.com</a>		
<b>Accessories</b>			
End plate, gray	APFN 2,5 E	07.312.7355.0	10
Partition, gray	TWFN 2,5 E	07.312.7455.0	10

## Connectors

### WBF 2,5/..../.

- Connectors for DIN rail terminal blocks with plug-in connection

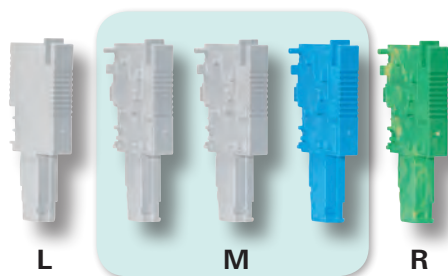

Description	Type	Part No.	Std. Pack
<b>Connectors LEFT</b>			
gray	WBF 2,5 1/L/GR	Z1.110.8955.0	50
blue	WBF 2,5 1/L/BL	Z1.110.8955.6	50
green/yellow	WBF 2,5 1/L/SL	Z1.110.8955.7	50
<b>Connectors MIDDLE</b>			
gray	WBF 2,5 1/M/GR	Z1.110.8855.0	50
blue	WBF 2,5 1/M/BL	Z1.110.8855.6	50
green/yellow	WBF 2,5 1/M/SL	Z1.110.8855.7	50
<b>Connectors RIGHT</b>			
gray	WBF 2,5 1/R/GR	Z1.110.9055.0	50
blue	WBF 2,5 1/R/BL	Z1.110.9055.6	50
green/yellow	WBF 2,5 1/R/SL	Z1.110.9055.7	50
<b>Connectors preassembled, gray</b>			
1 pole	WBF 2,5-1	59.903.0155.0	50
2 pole	WBF 2,5-2	59.903.0255.0	50
3 pole	WBF 2,5-3	59.903.0355.0	50
4 pole	WBF 2,5-4	59.903.0455.0	50
5 pole	WBF 2,5-5	59.903.0555.0	50
6 pole	WBF 2,5-6	59.903.0655.0	25
7 pole	WBF 2,5-7	59.903.0755.0	25
8 pole	WBF 2,5-8	59.903.0855.0	25
9 pole	WBF 2,5-9	59.903.0955.0	25
10 pole	WBF 2,5-10	59.903.1055.0	25
<b>General data</b>			
Width / length / height, incl. TS 7.5	5 mm		
Wire strip length	11 mm		
Approvals			
<b>Technical data</b>		<b>IEC</b>	<b>UL</b>
		<b>CSA</b>	
	EN 60947-7-1/-2		
Cross section fine-stranded	0.13 – 4 mm <sup>2</sup>		
Cross section solid/stranded	0.13 – 4 mm <sup>2</sup>		
Cross section, AWG		24 – 12	24 – 12
Rated current	32 A*	20 A	20 A
Rated voltage	500 V	500 V	500 V
Rated impulse voltage	8 kV		
Pollution degree	3		
<b>Note</b>	* Observe the derating curve, available in our e-catalog at <a href="https://eshop.wieland-electric.com">https://eshop.wieland-electric.com</a>		
<b>Accessories</b>			
	Type	Part No.	Std. Pack
Strain relief	Z-WBF	05.567.9155.0	10
Screwdriver, uninsulated	DIN 5264 B 0,6x3,5	06.502.4000.0	10
Screwdriver, MINI	DIN 5264 B 0,6x3,5 M	06.502.5000.0	10

## Accessories for fasis WKFN 2,5...



Accessories	Type	Part No.	Std. Pack	
Cross connector, insulated, for	2 blocks	IVB WKF 2,5-2	Z7.280.6227.0	10
	3 blocks	IVB WKF 2,5-3	Z7.280.6327.0	10
	4 blocks	IVB WKF 2,5-4	Z7.280.6427.0	10
	5 blocks	IVB WKF 2,5-5	Z7.280.6527.0	10
	6 blocks	IVB WKF 2,5-6	Z7.280.6627.0	10
	7 blocks	IVB WKF 2,5-7	Z7.280.6727.0	20
	8 blocks	IVB WKF 2,5-8	Z7.280.6827.0	20
	9 blocks	IVB WKF 2,5-9	Z7.280.6927.0	20
	10 blocks	IVB WKF 2,5-10	Z7.280.7027.0	20
	20 blocks	IVB WKF 2,5-20	Z7.280.8027.0	20
Wire entry guide	0.13–0.2 mm <sup>2</sup>	LELN 2,5/1 WEISS	05.564.3755.0	100
	0.25–0.5 mm <sup>2</sup>	LELN 2,5/1 GRAU	05.564.3855.0	100
	0.75–1.0 mm <sup>2</sup>	LELN 2,5/1 SCHWARZ	05.564.3955.0	100
Cover with warning symbol over 4 blocks	yellow	ADFN 2,5/4 GELB	04.343.8353.8	10
Test adapter, modular	PS WKC/F	Z1.299.9753.0	10	
Screwdriver, uninsulated	DIN 5264 B 0,6x3,5	06.502.4000.0	5	
Screwdriver, uninsulated, MINI	DIN 5264 B 0,6x3,5 M	06.502.5000.0	10	

# DIN rail terminal blocks with tension spring and pluggable connections

## WKF 2,5 D2/8113/35

- Duo feed-through block for mounting on TS 35
- Nominal cross section 2.5 mm<sup>2</sup>

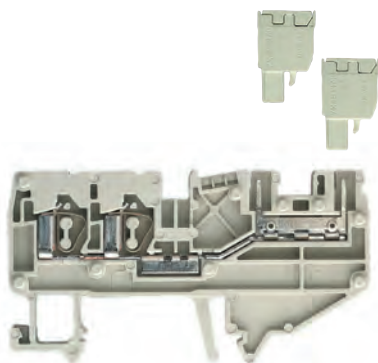

Description	Type	Part No.	Std. Pack
Du feed-through block, gray	WKF 2,5 D2/8113/35	56.703.2053.0	100
Duo feed-through block, blue	WKF 2,5 D2/8113/35 BLAU	56.703.2053.6	100
<b>General data</b>			
Width / length / height, incl. TS 7.5	5 mm / 76 mm / 42 mm		
Wire strip length	11 mm		
Approvals			
<b>Technical data</b>	<b>IEC</b>	<b>UL</b>	<b>CSA</b>
	EN 60947-7-1		
Cross section fine-stranded	0.13 – 2.5 mm <sup>2</sup>		
Cross section solid/stranded	0.13 – 4 mm <sup>2</sup>		
Cross section, AWG		22 – 12	24 – 12
Rated current	16 A	15 A	15 A
Rated voltage	250 V	300 V	300 V
Rated impulse voltage	4 kV		
Pollution degree	3		
<b>Accessories</b>			
End plate, gray	APF 2,5/D2/8113	07.312.4153.0	10
End plate, blue	APF 2,5/D2/8113	07.312.4153.6	10
Wire entry guide	0.13–0.2 mm <sup>2</sup> LEL 2,5/1 WEISS	05.561.6553.0	100
	0.25–0.5 mm <sup>2</sup> LEL 2,5/2 GRAU	05.561.6653.0	100
	0.75–1.0 mm <sup>2</sup> LEL 2,5/3 SCHWARZ	05.561.6753.0	100
Cover with warning symbol over 4 blocks	ADF 2,5/4 GELB	04.343.6053.8	10

## WKF 2,5 D2/8113/SL/35

- Duo-Ground block for mounting on TS 35
- Nominal cross section 2.5 mm<sup>2</sup>



Description	Type	Part No.	Std. Pack
Duo-Ground block, green/yellow	WKF 2,5 D2/8113 SL/35	56.703.9253.0	100
<b>General data</b>			
Width / length / height, incl. TS 7.5	5 mm / 76 mm / 42 mm		
Wire strip length	11 mm		
Approvals			
<b>Technical data</b>	<b>IEC</b>	<b>UL</b>	<b>CSA</b>
	EN 60947-7-1		
Cross section fine-stranded	0.13 – 2.5 mm <sup>2</sup>		
Cross section solid/stranded	0.13 – 4 mm <sup>2</sup>		
Cross section, AWG		22 – 12	24 – 12
Rated current	16 A		
Rated voltage	250 V	300 V	300 V
Rated impulse voltage	4 kV		
Pollution degree	3		
<b>Accessories</b>			
End plate, gray	APF 2,5/D2/8113	07.312.4153.0	10
Wire entry guide	0.13–0.2 mm <sup>2</sup> LEL 2,5/1 WEISS	05.561.6553.0	100
	0.25–0.5 mm <sup>2</sup> LEL 2,5/2 GRAU	05.561.6653.0	100
	0.75–1.0 mm <sup>2</sup> LEL 2,5/3 SCHWARZ	05.561.6753.0	100
Cover with warning symbol over 4 blocks	ADF 2,5/4 GELB	04.343.6053.8	10

## WKF 1,5 E/8113/35

- Multi-tier block for mounting on TS 35
- Nominal cross section 1.5 mm<sup>2</sup>

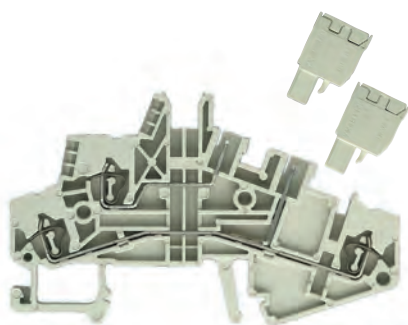

Description	Type	Part No.	Std. Pack
Multi-tier block, gray	WKF 1,5 E/8113/35	56.702.2053.0	100
<b>General data</b>			
Width / length / height, incl. TS 7.5	5 mm / 83 mm / 51 mm		
Wire strip length	8 mm		
Approvals			
<b>Technical data</b>	<b>IEC</b>	<b>UL</b>	<b>CSA</b>
	EN 60947-7-1		
Cross section fine-stranded	0.13 – 1.5 mm <sup>2</sup>		
Cross section solid/stranded	0.13 – 2.5 mm <sup>2</sup>		
Cross section, AWG		22 – 12	24 – 12
Rated current	16 A		
Rated voltage	250 V		
Rated impulse voltage	4 kV		
Pollution degree	3		
<b>Accessories</b>			
End plate, gray	APF 1,5/E/8113	07.312.4753.0	10
Wire entry guide	0.13–0.2 mm <sup>2</sup> LEL 1,5/1 WEISS	05.562.2453.0	100
	0.25–0.5 mm <sup>2</sup> LEL 1,5/2 GRAU	05.562.2553.0	100
	0.75–1.0 mm <sup>2</sup> LEL 1,5/3 SCHWARZ	05.562.2653.0	100
Cover with warning symbol over 4 blocks	ADF 1,5/4 GELB	04.343.8353.8	10

### WKF 1,5 E/35

- Multi-tier block for mounting on TS 35
- Nominal cross section 1.5 mm<sup>2</sup>



Description	Type	Part No.	Std. Pack
Multi-tier block, gray	WKF 1,5 E/35	56.702.7053.0	100
<b>General data</b>			
Width / length / height, incl. TS 7.5	5 mm / 83 mm / 51 mm		
Wire strip length	8 mm		
Approvals			
<b>Technical data</b>		<b>IEC</b>	<b>UL</b>
	EN 60947-7-1		
Cross section fine-stranded	0.13 – 1.5 mm <sup>2</sup>		
Cross section solid/stranded	0.13 – 2.5 mm <sup>2</sup>		
Cross section, AWG		30 – 14	30 – 14
Rated current	17,5 A	15 A	15 A
Rated voltage	400 V	300 V	600 V
Rated impulse voltage	6 kV		
Pollution degree	3		
<b>Accessories</b>			
End plate, gray	APF 1,5 E	07.312.3553.0	10
Partition, gray	TWF 1,5 E	07.312.3653.0	10
Wire entry guide	0.13 – 0.2 mm <sup>2</sup>	LEL 1,5/1 WEISS	05.562.2453.0
	0.25 – 0.5 mm <sup>2</sup>	LEL 1,5/2 GRAU	05.562.2553.0
	0.75 – 1.0 mm <sup>2</sup>	LEL 1,5/3 SCHWARZ	05.562.2653.0
Cover with warning symbol over 4 blocks	ADF 1,5/4 GELB	04.343.8353.8	10

### wiecon PC board connector

#### Type 8113 BFK

- Spring clamp/tension spring system
- 5 mm spacing, nominal cross section 2,5 mm<sup>2</sup>
- Accessories: coding pice 05.561.9153.0
- Rated voltages: VDE 0110/01.89  
250 V/4 kV/3 – Overvoltage category III  
400 V/4 kV/2 – Overvoltage category II  
1000 V/4 kV/1 – Overvoltage category I

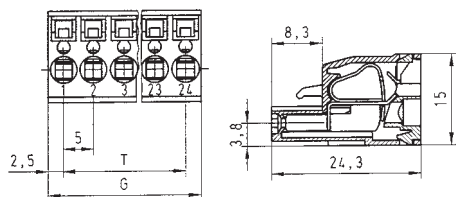

G	T	Pole	Part No.	Part No.	Std. Pack
<b>5 mm spacing</b>			<b>unmarked</b>	<b>marked</b>	
10.00	5.00	2	25.920.3253.0	25.920.0253.0	100
15.00	10.00	3	25.920.3353.0	25.920.0353.0	100
20.00	15.00	4	25.920.3453.0	25.920.0453.0	50
25.00	20.00	5	25.920.3553.0	25.920.0553.0	50
30.00	25.00	6	25.920.3653.0	25.920.0653.0	50
35.00	30.00	7	25.920.3753.0	25.920.0753.0	50
40.00	35.00	8	25.920.3853.0	25.920.0853.0	50
45.00	40.00	9	25.920.3953.0	25.920.0953.0	50
50.00	45.00	10	25.920.4053.0	25.920.1053.0	50
55.00	50.00	11	25.920.4153.0	25.920.1153.0	50
60.00	55.00	12	25.920.4253.0	25.920.1253.0	50
65.00	60.00	13	25.920.4353.0	25.920.1353.0	50
70.00	65.00	14	25.920.4453.0	25.920.1453.0	50
75.00	70.00	15	25.920.4553.0	25.920.1553.0	50
80.00	75.00	16	25.920.4653.0	25.920.1653.0	50
17- to 24- pole configurations upon request					
<b>General data</b>					
Wire strip length	9 mm				
Approvals					
<b>Technical data</b>		<b>IEC</b>	<b>UL</b>	<b>CSA</b>	
	EN 60947-7-1				
Cross section fine-stranded	0.13 – 2.5 mm <sup>2</sup>				
Cross section solid/stranded	0.13 – 4 mm <sup>2</sup>				
Cross section, AWG			22 – 12	22 – 12	
Rated current	12 A		12 A	12 A	
Rated voltage			300 V	300 V	
Rated impulse voltage					
Pollution degree					

## Accessories for *fasis* WKF 2,5 D... and WKF 1,5 E...



Accessories	Type	Part No.	Std. Pack
Cross connector, insulated	2 pole	IVB WKF 2,5–2	Z7.280.6227.0
	3 pole	IVB WKF 2,5–3	Z7.280.6327.0
	4 pole	IVB WKF 2,5–4	Z7.280.6427.0
	5 pole	IVB WKF 2,5–5	Z7.280.6527.0
	6 pole	IVB WKF 2,5–6	Z7.280.6627.0
	7 pole	IVB WKF 2,5–7	Z7.280.6727.0
	8 pole	IVB WKF 2,5–8	Z7.280.6827.0
	9 pole	IVB WKF 2,5–9	Z7.280.6927.0
	10 pole	IVB WKF 2,5–10	Z7.280.7027.0
	20 pole	IVB WKF 2,5–20	Z7.280.8027.0
	Cover with warning symbol over 4 poles	yellow	AD 8113/4 GELB
Screwdriver, uninsulated		DIN 5264 B 0,6x3,5	06.502.4000.0
Coding strip			05.561.0053.0

## Initiator and actuator blocks with tension spring connection

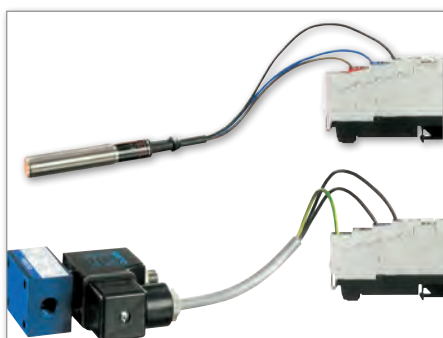
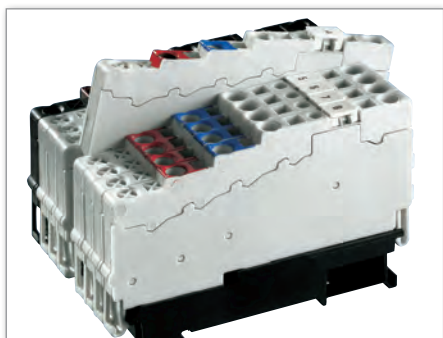
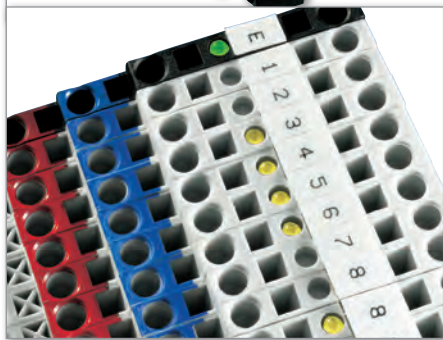
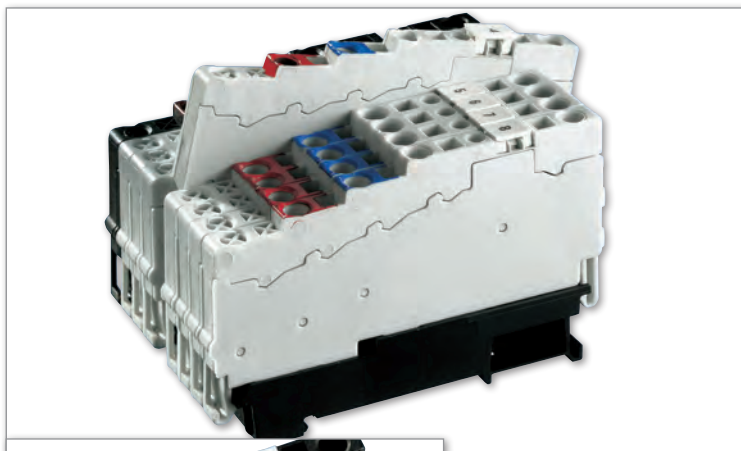

For machine and system control wiring, practice-oriented solutions are preferred that are primarily economical and reliable and thus contribute to the system's operational and functional safety.

**fasis** KOI was designed to connect the great variety of initiators and actuators to central and remote control systems. The initiator and actuator blocks of type WKF 1,5 KOI have, in particular, been conceived for the requirements in machine and system engineering. They facilitate the wiring task through clearly arranged termination points and an easily accessible and operable tension spring technology.

**fasis** KOI is a compact and efficient wiring system for connection purposes, potential distribution and transmission of signals from initiators and actuators.

### System features and benefits

- Control-compatible system solutions through accurate matching of the connection modules' number of poles to the input and output modules of the PLC.
- Flexible connection module mounting options with either snap-on TS 35 DIN rail mount, or direct mounting to a backplane with screws.
- Application-specific individual terminal block as a link between initiators, actuators and the PLC.

### Economically designed

- Low space requirements due to compact dimensioning of the individual terminal blocks and integration of the potential distribution inside the connection module.
- Efficient installation and start-up of the wiring system by simply fitting the connection module with components, making further accessories unnecessary.
- Reduction of the warehousing costs due to a low variety of parts without having to forego flexibility in the application.

### Service-friendly operation

- Short maintenance times for modifications of the terminal block assembly by replacing or extending individual blocks without interrupting the power supply of the other initiator and actuator blocks.
- Immediate visual monitoring of the switching states due to integrated light-emitting diodes.
- No maintenance required due to a permanently secure and dynamic tension spring clamp connection system.

### Application specific options

- Power supply to the connection modules through supply blocks, with optional LEDs.
- Potential distribution through connection modules in designs for 9 (1+8) or 18 (2x(1+8)) terminal blocks.
- Initiator blocks, for example for the connection of 3-wire or 4-wire proximity or position switches, with optional LEDs.
- Actuator terminals, for example for the connection of magnetic valves.



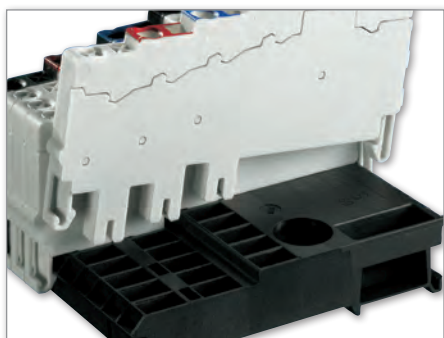

**Connection module**

**Collect and distribute potentials**

- Potential distribution is achieved quickly and safely as soon as the terminal blocks are snapped on.
- Cross connectors for the plus, minus and ground or screen potential are each integrated in the connection modules.
- The system does not require any additional cross connectors.



**Wire entry guides**

**Connect small cross sections safely**

- Wire entry guides prevent the wires from being inserted too deeply (smaller than 1 mm<sup>2</sup>) and enable an easy, professional and quick installation.
- Ensure the connection of solid and fine-stranded wires smaller than 1 mm<sup>2</sup>.
- Also see the accessories for DIN rail terminal blocks starting at page 124!



**Marking system**

**All clamping points marked clearly**

- Marking tags easily readable even with the wires connected.
- Clear assignment of wire to the termination point while wiring.
- Simplified troubleshooting for servicing.
- Customized marking with the **wiemark** and **wieplot** marking systems.

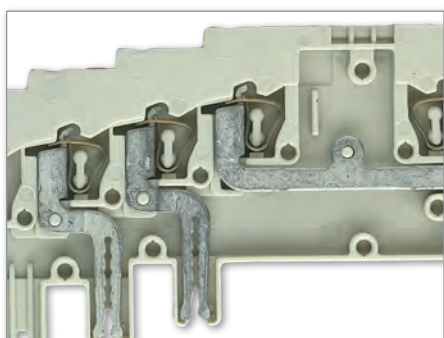

**Materials**

**High-quality materials**

- Special alloys enable low feed-through resistance and provide a gas-tight contact area:
  - clamping spring: stainless CrNi steel
  - current-carrying bar: tin-plated copper
- Polyamide has excellent electrical, chemical and mechanical characteristics:
  - temperature resistance: up to 120°C
  - creepage resistance: CTI 600
  - flammability class: self-extinguishing, UL94-V2



# Initiator and actuator blocks with tension spring connection

## WKF 1,5 KOI 3L...

- Initiator block with tension spring connection for mounting on TS 35
- Nominal cross section 1.5 mm<sup>2</sup>



37.702.7453.0  
\* 65 V/1.5 kV/3

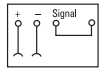

37.702.8453.0  
\* DC 24 V  
same as picture,  
but with LED



Description	Type	Part No.	Std. Pack
Initiator block, gray	WKF 1,5 KOI 3L	37.702.7453.0	50
Initiator block with LED, gray	WKF 1,5 KOI 3L-PGE	37.702.8453.0	50
<b>General data</b>			
Width / length / height, incl. TS 7.5	5 mm / 71 mm / 48 mm		
Wire strip length	10 mm		
Approvals			
<b>Technical data</b>	<b>IEC</b>	<b>UL</b>	<b>CSA</b>
	EN 60947-7-1		
Cross section fine-stranded	0.13 – 1.5 mm <sup>2</sup>		
Cross section solid/stranded	0.13 – 1.5 mm <sup>2</sup>		
Cross section, AWG	22 – 16	28 – 16	
Rated current	10 A	10 A	10 A
Rated voltage	*	65 V	65 V
Rated impulse voltage			
Pollution degree			
<b>Accessories</b>			
Wire entry guide	Type	Part No.	Std. Pack
	0.13–0.2 mm <sup>2</sup>	LEL 1,5/1 WEISS	05.562.2453.0
	0.25–0.5 mm <sup>2</sup>	LEL 1,5/2 GRAU	05.562.2553.0
	0.75–1.0 mm <sup>2</sup>	LEL 1,5/3 SCHWARZ	05.562.2653.0
Screwdriver, uninsulated	DIN 5264 B 0,6x3,5	06.502.4000.0	5

## WKF 1,5 KOI 3L/SL...

- Initiator block with tension spring connection for mounting on TS 35
- Nominal cross section 1.5 mm<sup>2</sup>

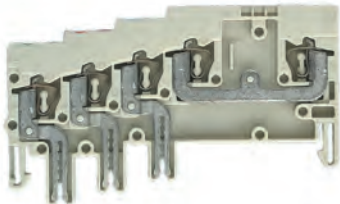

37.702.7553.0  
\* 65 V/1.5 kV/3

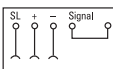

37.702.8553.0  
\* DC 24 V  
same as picture,  
but with LED



Description	Type	Part No.	Std. Pack
Initiator block, gray	WKF 1,5 KOI 3L/SL	37.702.7553.0	50
Initiator block with LED, gray	WKF 1,5 KOI 3L/SL-PGE	37.702.8553.0	50
<b>General data</b>			
Width / length / height, incl. TS 7.5	5 mm / 71 mm / 48 mm		
Wire strip length	10 mm		
Approvals			
<b>Technical data</b>	<b>IEC</b>	<b>UL</b>	<b>CSA</b>
	EN 60947-7-1		
Cross section fine-stranded	0.13 – 1.5 mm <sup>2</sup>		
Cross section solid/stranded	0.13 – 1.5 mm <sup>2</sup>		
Cross section, AWG	22 – 16	28 – 16	
Rated current	10 A	10 A	10 A
Rated voltage	*	65 V	65 V
Rated impulse voltage			
Pollution degree			
<b>Accessories</b>			
Wire entry guide	Type	Part No.	Std. Pack
	0.13–0.2 mm <sup>2</sup>	LEL 1,5/1 WEISS	05.562.2453.0
	0.25–0.5 mm <sup>2</sup>	LEL 1,5/2 GRAU	05.562.2553.0
	0.75–1.0 mm <sup>2</sup>	LEL 1,5/3 SCHWARZ	05.562.2653.0
Screwdriver, uninsulated	DIN 5264 B 0,6x3,5	06.502.4000.0	5

## WKF 1,5 KOE...

- Supply block with tension spring connection for mounting on TS 35
- Nominal cross section 1.5 mm<sup>2</sup>



37.702.7753.0  
\* 65 V/1.5 kV/3

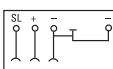

37.702.8753.0  
\* DC 24 V  
same as picture,  
but with LED



Description	Type	Part No.	Std. Pack
Supply block, black	WKF 1,5 KOE	37.702.7753.0	50
Supply block with LED, black	WKF 1,5 KOE-PGN	37.702.8753.0	50
<b>General data</b>			
Width / length / height, incl. TS 7.5	5 mm / 71 mm / 48 mm		
Wire strip length	10 mm		
Approvals			
<b>Technical data</b>	<b>IEC</b>	<b>UL</b>	<b>CSA</b>
	EN 60947-7-1		
Cross section fine-stranded	0.13 – 1.5 mm <sup>2</sup>		
Cross section solid/stranded	0.13 – 1.5 mm <sup>2</sup>		
Cross section, AWG	22 – 16	28 – 16	
Rated current	10 A	10 A	10 A
Rated voltage	*	65 V	65 V
Rated impulse voltage			
Pollution degree			
<b>Accessories</b>			
Wire entry guide	Type	Part No.	Std. Pack
	0.13–0.2 mm <sup>2</sup>	LEL 1,5/1 WEISS	05.562.2453.0
	0.25–0.5 mm <sup>2</sup>	LEL 1,5/2 GRAU	05.562.2553.0
	0.75–1.0 mm <sup>2</sup>	LEL 1,5/3 SCHWARZ	05.562.2653.0
Screwdriver, uninsulated	DIN 5264 B 0,6x3,5	06.502.4000.0	5

### WKF 1,5 KOA 2L...

- Actuator block with tension spring connection for mounting on TS 35
- Nominal cross section 1.5 mm<sup>2</sup>

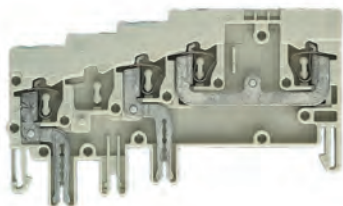

**37.702.7653.0**  
\* 65 V/1.5 kV/3



**37.702.8653.0**  
\* DC 24 V  
same as picture,  
but with LED



Description	Type	Part No.	Std. Pack
Actuator block, gray	WKF 1,5 KOA 2L	37.702.7653.0	50
Actuator block with LED, gray	WKF 1,5 KOA 2L/SL-PGE	37.702.8653.0	50

General data			
Width / length / height, incl. TS 7.5	5 mm / 71 mm / 48 mm		
Wire strip length	10 mm		
Approvals			
Technical data	IEC	UL	CSA
	EN 60947-7-1		
Cross section fine-stranded	0.13 – 1.5 mm <sup>2</sup>		
Cross section solid/stranded	0.13 – 1.5 mm <sup>2</sup>		
Cross section, AWG	28 – 16		
Rated current	10 A	10 A	
Rated voltage	*	65 V	
Rated impulse voltage			
Pollution degree			

Accessories		Type	Part No.	Std. Pack
Wire entry guide	0.13 – 0.2 mm <sup>2</sup>	LEL 1,5/1 WEISS	05.562.2453.0	100
	0.25 – 0.5 mm <sup>2</sup>	LEL 1,5/2 GRAU	05.562.2553.0	100
	0.75 – 1.0 mm <sup>2</sup>	LEL 1,5/3 SCHWARZ	05.562.2653.0	100
Screwdriver, uninsulated		DIN 5264 B 0,6x3,5	06.502.4000.0	5

### VM WKF ...

- Connection module for 9 or 18 blocks

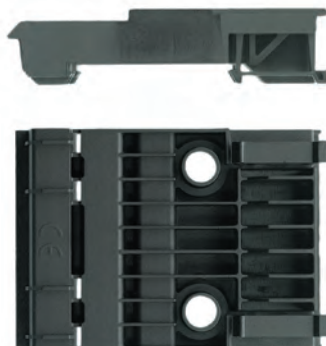

Description	Type	Part No.	Std. Pack
Connection module for 9 blocks, black	VM WKF KO..9	69.700.0953.0	10
Connection module for 18 blocks, black	VM WKF KO..18	69.700.1853.0	5

General data			
Length: 9 pole module	L = 9 x 5 mm + 1.5 mm		
Length: 18 pole module	L = 18 x 5 mm + 1.5 mm		
Approvals			
Technical data	IEC	UL	CSA
	EN 60947-7-1		
Cross section fine-stranded	0.13 – 1.5 mm <sup>2</sup>		
Cross section solid/stranded	0.13 – 1.5 mm <sup>2</sup>		
Cross section, AWG			
Rated current	10 A	10 A	
Rated voltage	*	65 V	
Rated impulse voltage			
Pollution degree			

## DIN rail terminal blocks with tension spring connection

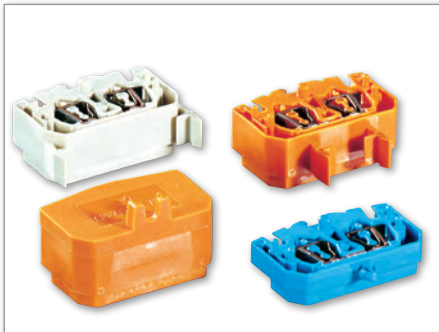
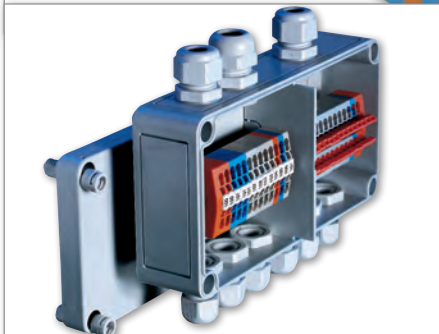
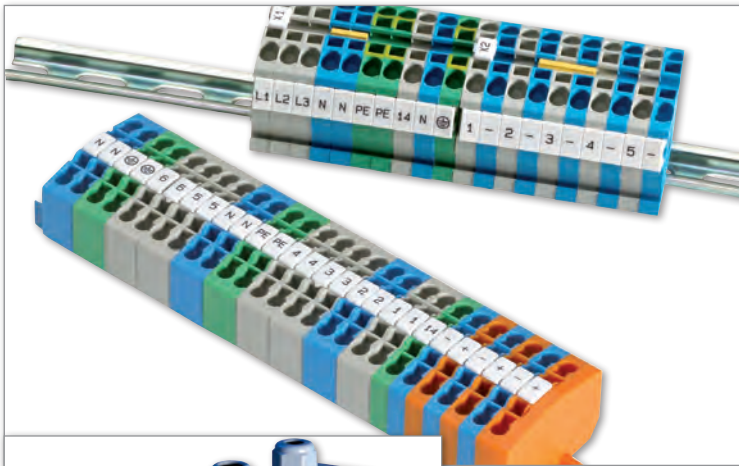

With our DIN rail terminal block system **fasis** MINI we focus on the application's size and flexibility. **fasis** MINI is a range of DIN rail terminal blocks in tension spring technology designed for installation in confined spaces.

The portfolio comprises ground blocks and feed-through blocks in various colors with 2 or 4 connections per potential.

The potential in the WKFM 2,5 terminal block series can be distributed, modified and extended quickly, flexibly and without problem by using cross connectors.

Designed to be mounted in various ways, including TS 35 and TS 15 DIN rails, backpanels, or inside distribution boxes, we provide different solutions including snap-on mounting feet, pins, and screw flanges.

### Solutions for confined spaces

- Space-saving miniature terminal blocks in many designs for installation inside distribution boxes, motors and applications with confined space requirements.
- Easy wiring with user-friendly screwdriver entry guides at the top of the block.
- Marking tags easily readable even with the wires connected.
- Customized assembly design and marking using **wieplan** and **wiemarc**.

### Application specific options

- Miniature terminal blocks with push-in mounting pin for installation directly onto the panel.
- Miniature terminal blocks with screw flange for installation directly onto the panel.
- Miniature terminal blocks for installation on TS 15 or TS 35 mounting rails.

### Customized assembly

- DIN rail terminal blocks of the **fasis** MINI series are available in 2 and 4 pole configurations.
- **fasis** MINI blocks can be snapped together with the integrated latching pins, with or without a mounting rail.
- The various potentials and terminal blocks are visually distinguished by several color variations.
- Individual marking using marking tags or customized printing of the terminal blocks.

### Permanent electrical connection



- The tension spring system provides a dynamic clamping connection. Load-controlled and thermal cold flow properties of the connected wires are balanced.
- Maintenance-free and gas-tight electrical connection as specified by the approvals. Customized layouts can be created individually.
- Separation of electrical and mechanical functions.

### WKMF 2,5/15

- Feed-through block with tension spring connection for mounting on TS 15
- Nominal cross section 2.5 mm<sup>2</sup>
- Ex e II  II 2GD  
Follow the EX installation instructions on page 149



Description	Type	Part No.	Std. Pack
Feed-through block, gray	WKMF 2,5/15	55.703.0053.0	100
Feed-through block, blue	WKMF 2,5/15	55.703.0053.6	100



General data				
Width / length / height, incl. TS 5.5	5 mm / 36 mm / 30 mm			
Wire strip length	10 mm			
Approvals	ATEX 		KEMA 03 ATEX 2071 U	
Technical data	IEC	UL	CSA	
	EN 60 947-7-1			EN 60 079-0/-7
Cross section fine-stranded	0.13–2.5 mm <sup>2</sup>			0.5–2.5 mm <sup>2</sup>
Cross section solid/stranded	0.13–2.5 mm <sup>2</sup>			0.5–2.5 mm <sup>2</sup>
Cross section, AWG		26–12	26–12	
Rated current	24 A	20 A	20 A	19/20 A <sup>1)</sup>
Rated voltage	500 V	600 V	300 V	275 V <sup>2)</sup>
Rated impulse voltage	6 kV			
Pollution degree	3			
<b>Note</b>	<sup>1)</sup> with/without jumper <sup>2)</sup> For maintaining the proper isolation distances, the open side of feed-through or ground blocks as well as both sides of a jumper are to be covered by partitions.			

### WKMF 2,5 SL/15

- Ground block with tension spring connection for mounting on TS 15
- Nominal cross section 2.5 mm<sup>2</sup>
- Ex e II  II 2GD  
Follow the EX installation instructions on page 149



Description	Type	Part No.	Std. Pack
	WKMF 2,5 SL/15	55.703.9053.0	100



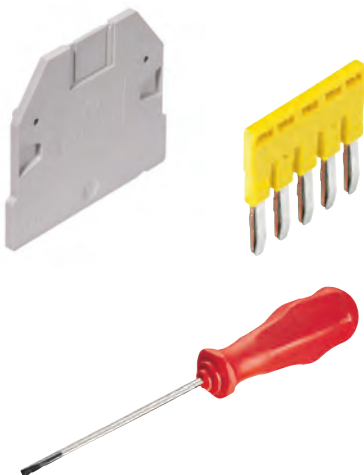

General data				
Width / length / height, incl. TS 5.5	5 mm / 36 mm / 30 mm			
Wire strip length	10 mm			
Approvals	ATEX 		KEMA 03 ATEX 2071 U	
Technical data	IEC	UL	CSA	
	EN 60 947-7-2			EN 60 079-0/-7
Cross section fine-stranded	0.13–2.5 mm <sup>2</sup>			0.5–2.5 mm <sup>2</sup>
Cross section solid/stranded	0.13–2.5 mm <sup>2</sup>			0.5–2.5 mm <sup>2</sup>
Cross section, AWG		26–12	26–12	
Rated current				
Rated voltage	500 V	600 V	300 V	<sup>1)</sup>
Rated impulse voltage	6 kV			
Pollution degree	3			
<b>Note</b>	<sup>1)</sup> For maintaining the proper isolation distances, the open side of feed-through or ground blocks as well as both sides of a jumper are to be covered by partitions.			





## Accessories for fasis WKMF 2,5...



Accessories	Type	Part No.	Std. Pack
End plate, 1.5 mm wide	gray APMF 2,5 /15	07.312.5953.0	10
Cross connector, insulated	2 pole IVB WKMF 2,5–2	Z7.260.0229.0	10
	3 pole IVB WKMF 2,5–3	Z7.260.0329.0	10
	4 pole IVB WKMF 2,5–4	Z7.260.0429.0	10
	5 pole IVB WKMF 2,5–5	Z7.260.0529.0	10
	10 pole IVB WKMF 2,5–10	Z7.260.1029.0	10
	50 pole IVB WKMF 2,5 M50	Z7.260.0029.0	10
Screwdriver, uninsulated	DIN 5264 B 0,6x3,5	06.502.4000.0	5
Screwdriver, uninsulated, MINI	DIN 5264 B 0,6x3,5 M	06.502.5000.0	10

## Mini terminal blocks with tension spring connection

Description	Type	Part No.	Std. Pack	
<b>WKF 2,5/M with flange</b>				
• Feed-through block with tension spring connection with or without flange				
• Nominal cross section 2.5 mm <sup>2</sup>				
				
				
WKF 2,5/M/F				
				
WKF 2,5/M				
<b>Description</b>	<b>Type</b>	<b>Part No.</b>	<b>Std. Pack</b>	
Feed-through block unmarked, gray	WKF 2,5/M	37.703.0553.0	100	
Feed-through block unmarked, blue	WKF 2,5/M BLAU	37.703.0553.6	100	
Feed-through block unmarked, orange	WKF 2,5/M ORANGE	37.703.0553.9	100	
Feed-through block with flange, gray	WKF 2,5/M/F	39.703.0153.0	100	
Feed-through block with flange, blue	WKF 2,5/M/F BLAU	39.703.0153.6	100	
Feed-through block with flange, orange	WKF 2,5/M/F ORANGE	39.703.0153.9	100	
<b>General data</b>				
Width / length / height	5 mm / 36 mm / 23 mm			
Wire strip length	11 mm			
Approvals				
<b>Technical data</b>	<b>IEC</b>	<b>UL</b>	<b>CSA</b>	
	EN 60947-7-1			
Cross section fine-stranded	0.13 – 2.5 mm <sup>2</sup>			
Cross section solid/stranded	0.13 – 4 mm <sup>2</sup>			
Cross section, AWG		22 – 12	24 – 12	
Rated current	24 A	20 A	25 A	
Rated voltage	800 V	600 V	600 V	
Rated impulse voltage	8 kV			
Pollution degree	3			

Description	Type	Part No.	Std. Pack	
<b>WKF 2,5/MD with flange</b>				
• Duo feed-through block with tension spring connection with or without flange				
• Nominal cross section 2.5 mm <sup>2</sup>				
				
				
WKF 2,5/MD/F				
				
WKF 2,5/MD				
<b>Description</b>	<b>Type</b>	<b>Part No.</b>	<b>Std. Pack</b>	
Duo feed-through block unmarked, gray	WKF 2,5/MD	37.703.1053.0	100	
Duo feed-through block unmarked, blue	WKF 2,5/MD BLAU	37.703.1053.6	100	
Duo feed-through block unmarked, orange	WKF 2,5/MD ORANGE	37.703.1053.9	100	
Duo feed-through block with flange, gray	WKF 2,5/MD/F	39.703.0253.0	100	
Duo feed-through block with flange, blue	WKF 2,5/MD/F BLAU	39.703.0253.6	100	
Duo feed-through block with flange, orange	WKF 2,5/MD/F ORANGE	39.703.0253.9	100	
<b>General data</b>				
Width / length / height	10 mm / 36 mm / 23 mm			
Wire strip length	11 mm			
Approvals				
<b>Technical data</b>	<b>IEC</b>	<b>UL</b>	<b>CSA</b>	
	EN 60947-7-1			
Cross section fine-stranded	0.13 – 2.5 mm <sup>2</sup>			
Cross section solid/stranded	0.13 – 4 mm <sup>2</sup>			
Cross section, AWG		22 – 12	24 – 12	
Rated current	24 A	20 A	25 A	
Rated voltage	800 V	600 V	600 V	
Rated impulse voltage	8 kV			
Pollution degree	3			

## Accessories for *fasis* WKF 2,5/M...

Accessories	Type	Part No.	Std. Pack
End plate with flange on the right	gray	APF 2,5/M.../F/R	07.312.3153.0
End plate with flange on the right	blue	APF 2,5/M.../F/R BLAU	07.312.3153.6
End plate with flange on the right	orange	APF 2,5/M.../F/R ORANGE	07.312.3153.9
Wire entry guide	0.13 – 0.2 mm <sup>2</sup>	LEL 2,5/1 WEISS	05.561.6553.0
Wire entry guide	0.25 – 0.5 mm <sup>2</sup>	LEL 2,5/2 GRAU	05.561.6653.0
Wire entry guide	0.75 – 1.0 mm <sup>2</sup>	LEL 2,5/3 SCHWARZ	05.561.6753.0
Cross connector, insulated	2 pole		05.902.3500.0
Marking strip, unmarked	(4 x 22 pcs.)		04.244.0053.0
Marking strip, marked	(1 – 11)		04.844.2053.0
Marking strip, marked	(12 – 55)		04.844.2153.0
Marking strip, marked	(56 – 99)		04.844.2253.0
Screwdriver, uninsulated	DIN 5264 B 0,6 x 3,5		06.502.4000.0

### WKF 2,5/M/R with mounting foot

- Feed-through block with tension spring connection, unmarked
- Nominal cross section 2.5 mm<sup>2</sup>



Mounting hole: Ø 3,5 mm  
Plate thickness: 0,6–1,2 mm

Description	Type	Part No.	Std. Pack
Feed-through block unmarked, gray	WKF 2,5/M/R	38.703.0553.0	100
Feed-through block unmarked, blue	WKF 2,5/M/R BLAU	38.703.0553.6	100
Feed-through block unmarked, orange	WKF 2,5/M/R ORANGE	38.703.0553.9	100
<b>General data</b>			
Width / length / height	5 mm / 36 mm / 23 mm		
Wire strip length	11 mm		
Approvals			
<b>Technical data</b>	<b>IEC</b>	<b>UL</b>	<b>CSA</b>
	EN 60947-7-1		
Cross section fine-stranded	0.13 – 2.5 mm <sup>2</sup>		
Cross section solid/stranded	0.13 – 4 mm <sup>2</sup>		
Cross section, AWG		22 – 12	24 – 12
Rated current	24 A	20 A	25 A
Rated voltage	800 V	600 V	600 V
Rated impulse voltage	8 kV		
Pollution degree	3		

### WKF 2,5/MD/R with mounting foot

- Duo feed-through block with tension spring connection, unmarked
- Nominal cross section 2.5 mm<sup>2</sup>



Mounting hole: Ø 3,5 mm  
Plate thickness: 0,6–1,2 mm

Description	Type	Part No.	Std. Pack
Duo feed-through block unmarked, gray	WKF 2,5/MD/R	38.703.1053.0	100
Duo feed-through block unmarked, blue	WKF 2,5/MD/R BLAU	38.703.1053.6	100
Duo feed-through block unmarked, orange	WKF 2,5/MD/R ORANGE	38.703.1053.9	100
<b>General data</b>			
Width / length / height	10 mm / 36 mm / 23 mm		
Wire strip length	11 mm		
Approvals			
<b>Technical data</b>	<b>IEC</b>	<b>UL</b>	<b>CSA</b>
	EN 60947-7-1		
Cross section fine-stranded	0.13 – 2.5 mm <sup>2</sup>		
Cross section solid/stranded	0.13 – 4 mm <sup>2</sup>		
Cross section, AWG		22 – 12	24 – 12
Rated current	24 A	20 A	25 A
Rated voltage	800 V	600 V	600 V
Rated impulse voltage	8 kV		
Pollution degree	3		

## Accessories for fasis WKF 2,5/M.../R

Accessories	Type	Part No.	Std. Pack
End plate	gray	APF 2,5/M...	07.312.2953.0
End plate	blue	APF 2,5/M... BLAU	07.312.2953.6
End plate	orange	APF 2,5/M... ORANGE	07.312.2953.9
Wire entry guide	0.13–0.2 mm <sup>2</sup>	LEL 2,5/1 WEISS	05.561.6553.0
Wire entry guide	0.25–0.5 mm <sup>2</sup>	LEL 2,5/2 GRAU	05.561.6653.0
Wire entry guide	0.75–1.0 mm <sup>2</sup>	LEL 2,5/3 SCHWARZ	05.561.6753.0
Cross connector, insulated	2 pole		05.902.3500.0
Marking strip, unmarked	(4 x 22 pcs.)		04.244.0053.0
	marked (1–11)		04.844.2053.0
	marked (12–55)		04.844.2153.0
	marked (56–99)		04.844.2253.0
Screwdriver, uninsulated	DIN 5264 B 0,6 x 3,5		06.502.4000.0

## Mini terminal blocks with tension spring connection

### WKF 2,5/M/15

- Feed-through block with tension spring connection, unmarked, for mounting on TS 15
- Nominal cross section 2.5 mm<sup>2</sup>



Description	Type	Part No.	Std. Pack
Feed-through block unmarked, gray	WKF 2,5/M/15	55.703.0553.0	100
Feed-through block unmarked, blue	WKF 2,5/M/15 BLAU	55.703.0553.6	100
Feed-through block unmarked, orange	WKF 2,5/M/15 ORANGE	55.703.0553.9	100
Feed-through block unmarked, green	WKF 2,5/M/15 GRÜN	55.703.0553.7	100

General data			
Width / length / height, incl. TS 5.5	5 mm / 36 mm / 27 mm		
Wire strip length	11 mm		
Approvals			
Technical data	IEC	UL	CSA
	EN 60947-7-1		
Cross section fine-stranded	0.13 – 2.5 mm <sup>2</sup>		
Cross section solid/stranded	0.13 – 4 mm <sup>2</sup>		
Cross section, AWG		22 – 12	24 – 12
Rated current	24 A	20 A	25 A
Rated voltage	800 V	600 V	600 V
Rated impulse voltage	8 kV		
Pollution degree	3		

### WKF 2,5/MD/15

- Duo feed-through block with tension spring connection, unmarked, for mounting on TS 15
- Nominal cross section 2.5 mm<sup>2</sup>



Description	Type	Part No.	Std. Pack
Duo feed-through block unmarked, gray	WKF 2,5/MD/15	55.703.1053.0	100
Duo feed-through block unmarked, blue	WKF 2,5/MD/15 BLAU	55.703.1053.6	100
Duo feed-through block unmarked, orange	WKF 2,5/MD/15 ORANGE	55.703.1053.9	100
Duo feed-through block unmarked, green	WKF 2,5/MD/15 GRÜN	55.703.1053.7	100

General data			
Width / length / height, incl. TS 5.5	10 mm / 36 mm / 27 mm		
Wire strip length	11 mm		
Approvals			
Technical data	IEC	UL	CSA
	EN 60947-7-1		
Cross section fine-stranded	0.13 – 2.5 mm <sup>2</sup>		
Cross section solid/stranded	0.13 – 4 mm <sup>2</sup>		
Cross section, AWG		22 – 12	24 – 12
Rated current	24 A	20 A	25 A
Rated voltage	800 V	600 V	600 V
Rated impulse voltage	8 kV		
Pollution degree	3		



### WKF 2,5/M/35

- Feed-through block with tension spring connection, unmarked, for mounting on TS 35
- Nominal cross section 2.5 mm<sup>2</sup>



Description	Type	Part No.	Std. Pack
Feed-through block unmarked, gray	WKF 2,5/M/35	56.703.0553.0	100
Feed-through block unmarked, blue	WKF 2,5/M/35 BLAU	56.703.0553.6	100
Feed-through block unmarked, orange	WKF 2,5/M/35 ORANGE	56.703.0553.9	100
Feed-through block unmarked, green	WKF 2,5/M/35 GRÜN	56.703.0553.7	100

General data				
Width / length / height, incl. TS 7.5	5 mm / 36 mm / 32 mm			
Wire strip length	11 mm			
Approvals				
Technical data		IEC	UL	CSA
	EN 60947-7-1			
Cross section fine-stranded	0.13 – 2.5 mm <sup>2</sup>			
Cross section solid/stranded	0.13 – 4 mm <sup>2</sup>			
Cross section, AWG	22 – 12		24 – 12	
Rated current	24 A	20 A	25 A	
Rated voltage	800 V	600 V	600 V	
Rated impulse voltage	8 kV			
Pollution degree	3			

### WKF 2,5/MD/35

- Duo-Feed-through block with tension spring connection, unmarked, for mounting on TS 35
- Nominal cross section 2.5 mm<sup>2</sup>



Description	Type	Part No.	Std. Pack
Duo-Feed-through block unmarked, gray	WKF 2,5/MD/35	56.703.1053.0	100
Duo-Feed-through block unmarked, blue	WKF 2,5/MD/35 BLAU	56.703.1053.6	100
Duo-Feed-through block unmarked, orange	WKF 2,5/MD/35 ORANGE	56.703.1053.9	100
Duo-Feed-through block unmarked, green	WKF 2,5/MD/35 GRÜN	56.703.1053.7	100

General data				
Width / length / height, incl. TS 7.5	10 mm / 36 mm / 32 mm			
Wire strip length	11 mm			
Approvals				
Technical data		IEC	UL	CSA
	EN 60947-7-1			
Cross section fine-stranded	0.13 – 2.5 mm <sup>2</sup>			
Cross section solid/stranded	0.13 – 4 mm <sup>2</sup>			
Cross section, AWG	22 – 12		24 – 12	
Rated current	24 A	20 A	25 A	
Rated voltage	800 V	600 V	600 V	
Rated impulse voltage	8 kV			
Pollution degree	3			

## Accessories for *fasis* WKF 2,5/M...

Accessories	Type	Part No.	Std. Pack	
End plate	gray	APF 2,5/M...	07.312.2953.0	10
End plate	blue	APF 2,5/M... BLAU	07.312.2953.6	10
End plate	orange	APF 2,5/M... ORANGE	07.312.2953.9	10
Wire entry guide	0.13 – 0.2 mm <sup>2</sup>	LEL 2,5/1 WEISS	05.561.6553.0	100
Wire entry guide	0.25 – 0.5 mm <sup>2</sup>	LEL 2,5/2 GRAU	05.561.6653.0	100
Wire entry guide	0.75 – 1.0 mm <sup>2</sup>	LEL 2,5/3 SCHWARZ	05.561.6753.0	100
Cross connector, insulated	2 pole		05.902.3500.0	10
Marking strip, (4 x 22 pcs.)	unmarked	(1 – 11)	04.244.0053.0	5
	marked	(12 – 55)	04.844.2053.0	5
	marked	(56 – 99)	04.844.2153.0	5
	marked		04.844.2253.0	5
	yellow, unmarked		04.244.0053.8	5
Screwdriver, uninsulated	DIN 5264 B 0,6 x 3,5		06.502.4000.0	5

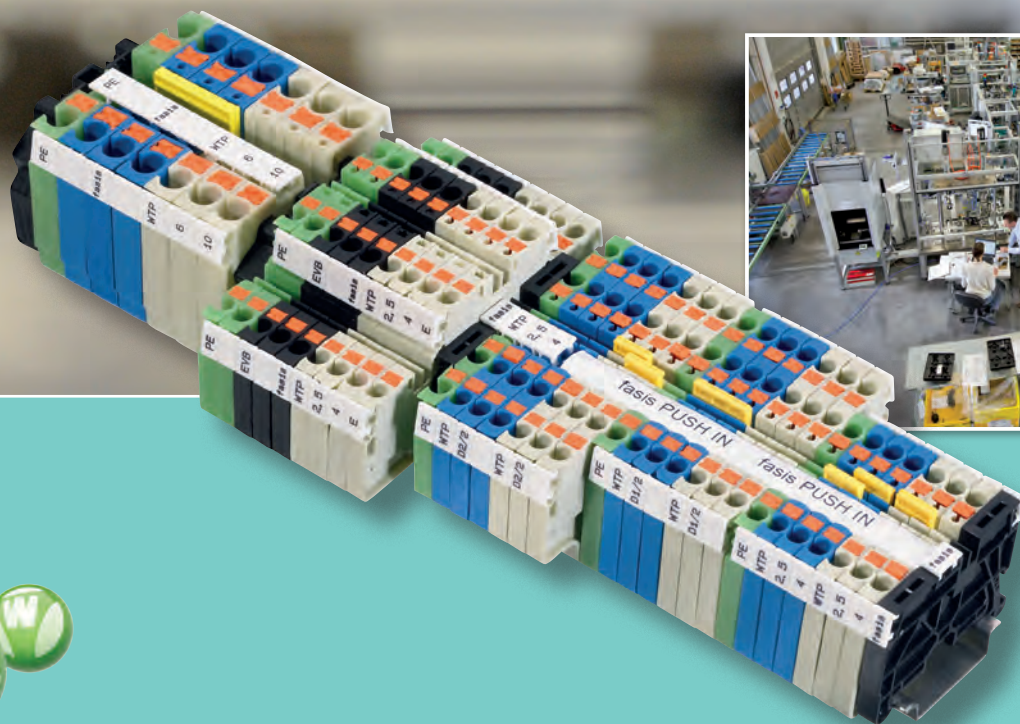
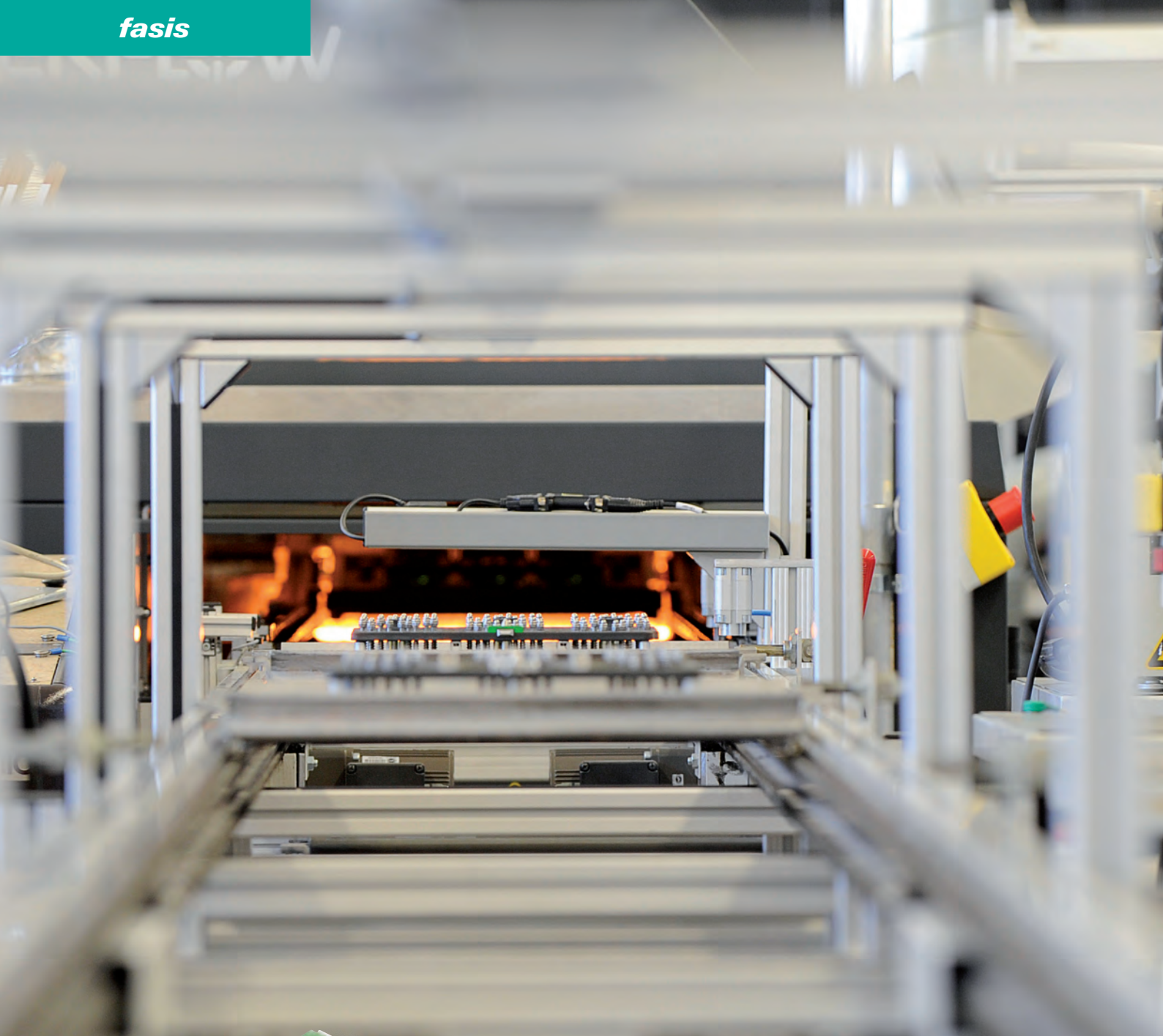

## **fasis** WTP – DIN rail terminal blocks with **push-in connection**

Terminate wires easily, directly and without tools!

**fasis** WTP – DIN rail terminal blocks with push-in connection. Built according to an effective and comprehensive concept, including compact design and high-performance contact technology, **fasis** WTP reduces installation time and keeps inventory costs to a minimum.

The product line includes feed-through and ground blocks with 2, 3 or 4 termination points, as well as multi-tier blocks.

**fasis** WTP has been designed for use in machinery and plant engineering, as well as power distribution for buildings.

Connection cross-sections up to 10 mm<sup>2</sup>

Rated current of up to 57 A

Rated voltage of up to 1000 V

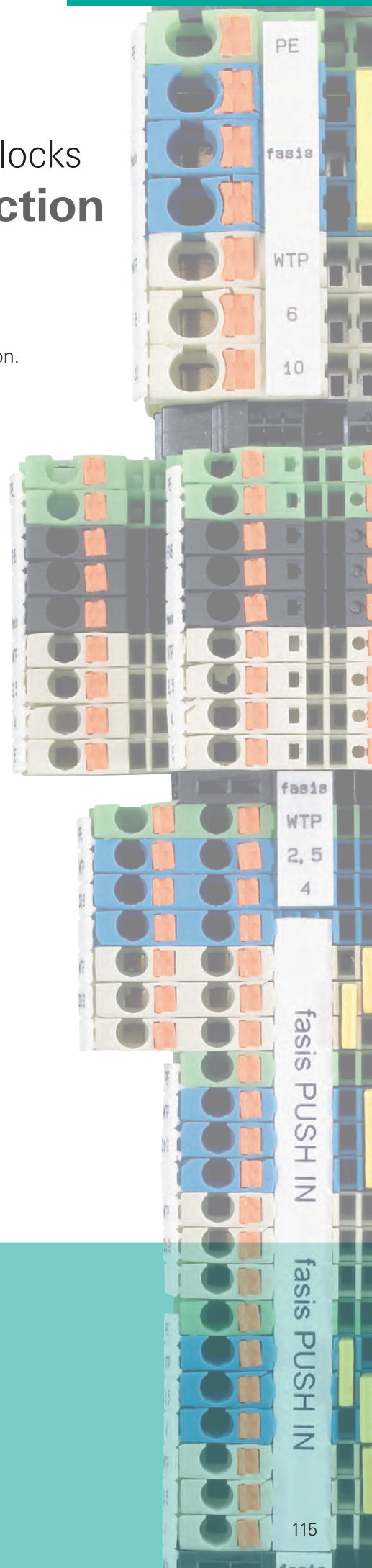
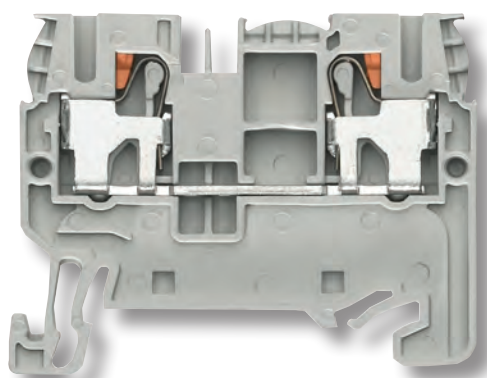

## fasis WTP – wires simply push-in

### Connect without tools

- Push-in connection
- Wires connect directly

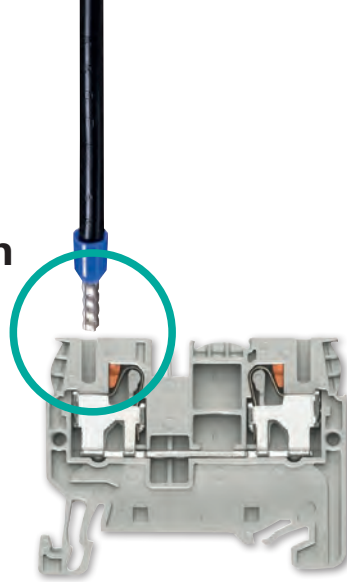

fasis push-in				
Nominal cross section	2.5 mm <sup>2</sup>	4 mm <sup>2</sup>	6 mm <sup>2</sup>	10 mm <sup>2</sup>
Rated current	32 A		57 A	
Width	5 mm		8 mm	
	⇩		⇩	
	<b>WTP 2,5/4</b>		<b>WTP 6/10</b>	

### The same functionality – fewer items

- 2.5 & 4 mm<sup>2</sup> and 6 & 10 mm<sup>2</sup> in one block

### Integrated release lever

- No mix-up of wire-entry and screwdriver entry points
- No contact with live parts
- Use of Philips head screwdriver also possible

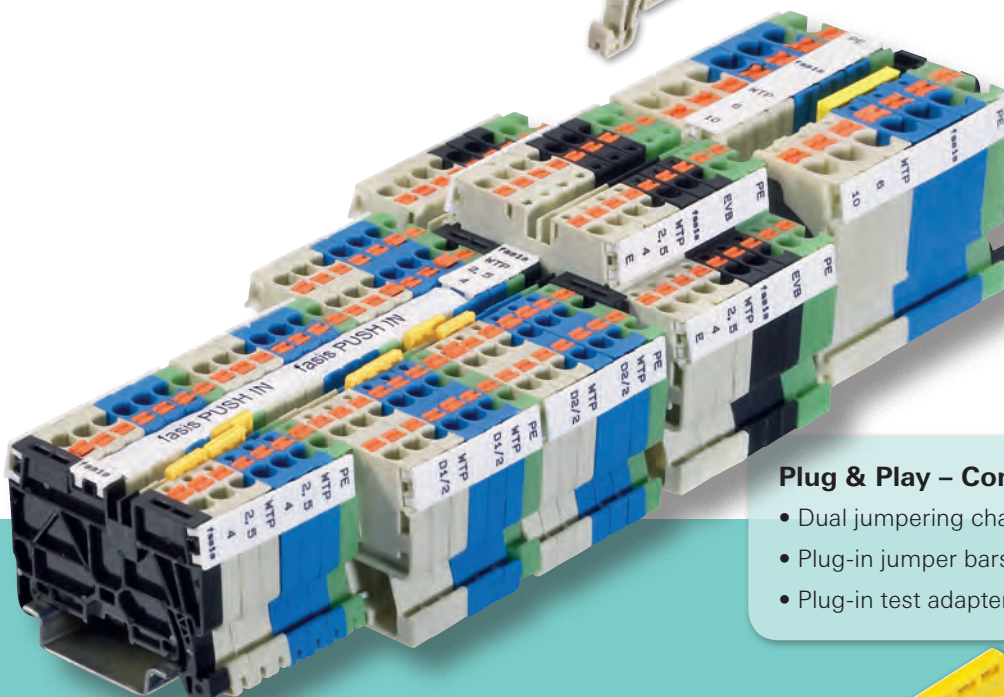
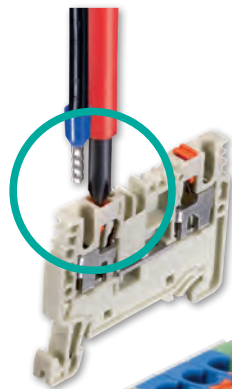

### Plug & Play – Completing the Concept

- Dual jumpering channels
- Plug-in jumper bars
- Plug-in test adapter



## Wieland jumpering system – Perfect technology

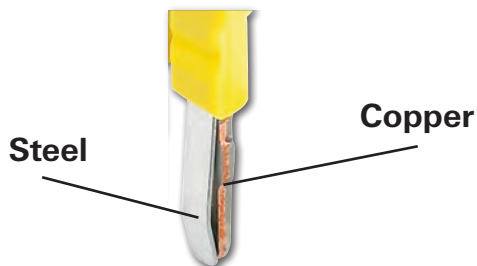
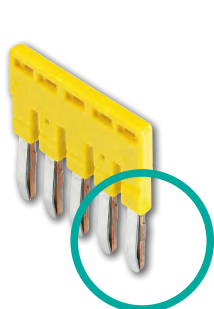

### Perfect technology

- Copper current bar guarantees low contact resistance
- Steel spring guarantees strength, durability, and long-term stability

### Extremely rugged!

- Indestructible steel spring
- Vibration-proof connection



### Simple customization

- Individual poles easy to remove
- Circuits easy to identify



## Wieland marking system – Reliable identification

### Marking strips – Dependable

- Maximum hold to the terminal
- Solidify integrity of the assembly

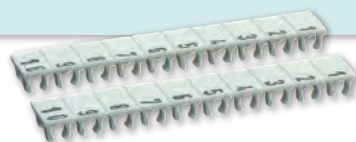

### Endless strip – Effective

- Mounting facility for endless strips permits single step marking of entire assembly
- Continuous labeling
- Uses commercially available labeling systems



### Marking tags – Individual

- Individual labeling with minimum effort
- Ideal for service and maintenance



## Feed-through blocks with push-in connection

### WTP 2,5/4

- Feed-through block with push-in connection for mounting on TS 35
- Nominal cross section 4 mm<sup>2</sup>

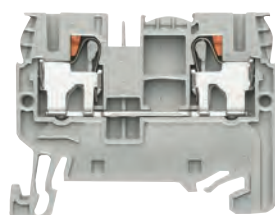

Description	Type	Part No.	Std. Pack
Feed-through block, gray	WTP 2,5/4	56.203.0055.0	100
Feed-through block, blue	WTP 2,5/4 BLAU	56.203.0055.6	100

General data				
Width / length / height, incl. TS 7.5	5 mm / 47 mm / 38 mm			
Wire strip length	11 mm			
Approvals				
Technical data	IEC	UL	CSA	Ⓢ
	EN 60 947-7-1	pending	pending	pending
Cross section fine-stranded	0.2–4 mm <sup>2</sup>			
Cross section solid/stranded	0.2–4 mm <sup>2</sup>			
Cross section, AWG		24–12	24–12	
Rated current	32 A	30 A	30 A	
Rated voltage	800 V*	600 V	600 V	
Rated impulse voltage	8 kV			
Pollution degree	3			
Accessories	Type	Part No.	Std. Pack	
End plate, gray	APFN 2,5	07.312.6755.0	10	
Partition, gray	TWFN 2,5	07.312.6855.0	10	

\* When cross connector IVB WKF 2,5-... is used, the rated voltage must be reduced to 630 V.

### WTP 2,5/4 D1/2

- Duo feed-through block with push-in connection for mounting on TS 35
- Nominal cross section 4 mm<sup>2</sup>

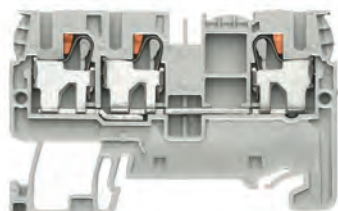

Description	Type	Part No.	Std. Pack
Feed-through block, gray	WTP 2,5/4 D1/2	56.203.5055.0	100
Feed-through block, blue	WTP 2,5/4 D1/2 BLAU	56.203.5055.6	100

General data				
Width / length / height, incl. TS 7.5	5 mm / 60 mm / 38 mm			
Wire strip length	11 mm			
Approvals				
Technical data	IEC	UL	CSA	Ⓢ
	EN 60 947-7-1	pending	pending	pending
Cross section fine-stranded	0.2–4 mm <sup>2</sup>			
Cross section solid/stranded	0.2–4 mm <sup>2</sup>			
Cross section, AWG		24–12	24–12	
Rated current	32 A	30 A	30 A	
Rated voltage	800 V*	600 V	600 V	
Rated impulse voltage	8 kV			
Pollution degree	3			
Accessories	Type	Part No.	Std. Pack	
End plate, gray	APFN 2,5 D1/2	07.312.6955.0	10	
Partition, gray	TWFN 2,5 D1/2	07.312.7055.0	10	

\* When cross connector IVB WKF 2,5-... is used, the rated voltage must be reduced to 630 V.

### WTP 2,5/4 D2/2

- Duo feed-through block with push-in connection for mounting on TS 35
- Nominal cross section 4 mm<sup>2</sup>

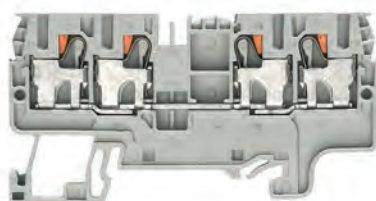



Description	Type	Part No.	Std. Pack
Feed-through block, gray	WTP 2,5/4 D2/2	56.203.5155.0	100
Feed-through block, blue	WTP 2,5/4 D2/2 BLAU	56.203.5155.6	100

General data				
Width / length / height, incl. TS 7.5	5 mm / 72 mm / 38 mm			
Wire strip length	11 mm			
Approvals				
Technical data	IEC	UL	CSA	Ⓢ
	EN 60 947-7-1	pending	pending	pending
Cross section fine-stranded	0.2–4 mm <sup>2</sup>			
Cross section solid/stranded	0.2–4 mm <sup>2</sup>			
Cross section, AWG		24–12	24–12	
Rated current	32 A	30 A	30 A	
Rated voltage	800 V*	600 V	600 V	
Rated impulse voltage	8 kV			
Pollution degree	3			
Accessories	Type	Part No.	Std. Pack	
End plate, gray	APFN 2,5 D2/2	07.312.7155.0	10	
Partition, gray	TWFN 2,5 D2/2	07.312.7255.0	10	



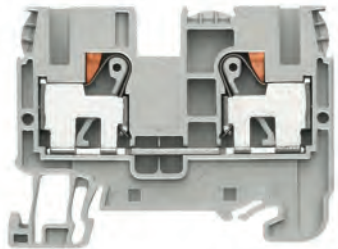

\* When cross connector IVB WKF 2,5-... is used, the rated voltage must be reduced to 630 V.

## Feed-through blocks with push-in connection

WTP 6/10		Description	Type	Part No.	Std. Pack
<ul style="list-style-type: none"> <li>• Feed-through block with push-in connection for mounting on TS 35</li> <li>• Nominal cross section 10 mm<sup>2</sup></li> </ul> 		Feed-through block, gray	WTP 6/10	56.206.0055.0	100
		Feed-through block, blue	WTP 6/10 BLAU	56.206.0055.6	100
<b>General data</b>					
Width / length / height, incl. TS 7.5		8 mm / 58 mm / 44 mm			
Wire strip length		15 mm			
Approvals					
<b>Technical data</b>					
		<b>IEC</b>	<b>UL</b>	<b>CSA</b>	<b>Ex</b>
		EN 60 947-7-1	pending	pending	pending
Cross section fine-stranded		0,2–10 mm <sup>2</sup>			
Cross section solid/stranded		0.2–10 mm <sup>2</sup>			
Cross section, AWG		24–8		24–8	
Rated current		57 A	50 A	50 A	
Rated voltage		1000 V*	600 V	600 V	
Rated impulse voltage		8 kV			
Pollution degree		3			
<b>Accessories</b>					
		Type		Part No.	Std. Pack
End plate, gray		AP WTP 6/10		07.313.4155.0	10
Partition, gray		TW WTP 6/10		07.313.4255.0	10

\* When cross connector IVB WKFN 6-... is used, the rated voltage must be reduced to 800 V.

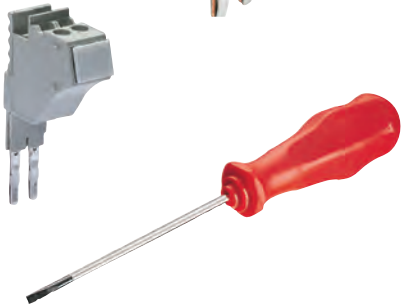
## Accessories for *fasis* WTP...

Accessories for WTP 2,5/4...		Type	Part No.	Std. Pack		
	Cross connector, insulated	2 pole	IVB WKF 2,5–2	Z7.280.6227.0	10	
		3 pole	IVB WKF 2,5–3	Z7.280.6327.0	10	
		4 pole	IVB WKF 2,5–4	Z7.280.6427.0	10	
		5 pole	IVB WKF 2,5–5	Z7.280.6527.0	10	
		6 pole	IVB WKF 2,5–6	Z7.280.6627.0	10	
		7 pole	IVB WKF 2,5–7	Z7.280.6727.0	20	
		8 pole	IVB WKF 2,5–8	Z7.280.6827.0	20	
		9 pole	IVB WKF 2,5–9	Z7.280.6927.0	20	
		10 pole	IVB WKF 2,5–10	Z7.280.7027.0	20	
		20 pole	IVB WKF 2,5–20	Z7.280.8027.0	20	
		Wire entry guide	0.13–0.2 mm <sup>2</sup>	LELN 2,5/1 WEISS	05.564.3755.0	100
			0.25–0.5 mm <sup>2</sup>	LELN 2,5/2 GRAU	05.564.3855.0	100
		0.75–1.0 mm <sup>2</sup>	LELN 2,5/3 SCHWARZ	05.564.3955.0	100	
	Test adapter, modular		PS WKC/F	Z1.299.9753.0	10	
	Test plug		ST 2/2,3	Z5.553.2921.0	10	
	Screwdriver, uninsulated		DIN 5264 B 0,6x3,5	06.502.4000.0	5	
	Screwdriver, uninsulated, MINI		DIN 5264 B 0,6x3,5 M	06.502.5000.0	10	
	<b>Accessories for WTP 6/10...</b>					
	Cross connector, insulated, I <sub>N</sub> : 41 A	2 pole	IVB WKFN 6–2	Z7.282.5227.0	10	
	(57 A when using	3 pole	IVB WKFN 6–3	Z7.282.5327.0	10	
	two cross connectors)	4 pole	IVB WKFN 6–4	Z7.282.5427.0	10	
		5 pole	IVB WKFN 6–5	Z7.282.5527.0	10	
	Test plug		ST 2/2,3	Z5.553.2921.0	10	
Screwdriver, uninsulated		DIN 5264 B 0,8x4	06.502.4100.0	5		

## Ground blocks with push-in connection

### WTP 2,5/4 PE

- Ground block with push-in connection for mounting on TS 35
- Nominal cross section 4 mm<sup>2</sup>

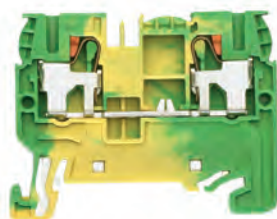

Description	Type	Part No.	Std. Pack
Ground block, green/yellow	WTP 2,5/4 PE	56.203.9055.0	100
<b>General data</b>			
Width / length / height, incl. TS 7.5	5 mm / 47 mm / 38 mm		
Wire strip length	11 mm		
Approvals			
<b>Technical data</b>	<b>IEC</b>	<b>UL</b>	<b>CSA</b>
	EN 60 947-7-2	pending	pending
Cross section fine-stranded	0.2–4 mm <sup>2</sup>		
Cross section solid/stranded	0.2–4 mm <sup>2</sup>		
Cross section, AWG		24–12	24–12
Rated current			
Rated voltage	800 V*	600 V	600 V
Rated impulse voltage	8 kV		
Pollution degree	3		
<b>Accessories</b>			
	Type	Part No.	Std. Pack
End plate, gray	APFN 2,5	07.312.6755.0	10
Partition, gray	TWFN 2,5	07.312.6855.0	10

\* When cross connector IVB WKF 2,5-... is used, the rated voltage must be reduced to 630 V.

### WTP 2,5/4 D1/2/PE

- Duo ground block with push-in connection for mounting on TS 35
- Nominal cross section 4 mm<sup>2</sup>

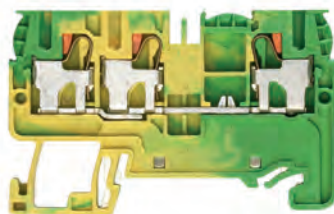

Description	Type	Part No.	Std. Pack
Ground block, green/yellow	WTP 2,5/4 D1/2/PE	56.203.9355.0	100
<b>General data</b>			
Width / length / height, incl. TS 7.5	5 mm / 60 mm / 38 mm		
Wire strip length	11 mm		
Approvals			
<b>Technical data</b>	<b>IEC</b>	<b>UL</b>	<b>CSA</b>
	EN 60 947-7-2	pending	pending
Cross section fine-stranded	0.2–4 mm <sup>2</sup>		
Cross section solid/stranded	0.2–4 mm <sup>2</sup>		
Cross section, AWG		24–12	24–12
Rated current			
Rated voltage	800 V*	600 V	600 V
Rated impulse voltage	8 kV		
Pollution degree	3		
<b>Accessories</b>			
	Type	Part No.	Std. Pack
End plate, gray	APFN 2,5 D1/2	07.312.6955.0	10
Partition, gray	TWFN 2,5 D1/2	07.312.7055.0	10

\* When cross connector IVB WKF 2,5-... is used, the rated voltage must be reduced to 630 V.

### WTP 2,5/4 D2/2/PE

- Duo ground block with push-in connection for mounting on TS 35
- Nominal cross section 4 mm<sup>2</sup>

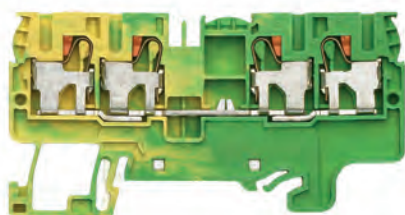

Description	Type	Part No.	Std. Pack
Ground block, green/yellow	WTP 2,5/4 D2/2/PE	56.203.9155.0	100
<b>General data</b>			
Width / length / height, incl. TS 7.5	5 mm / 72 mm / 38 mm		
Wire strip length	11 mm		
Approvals			
<b>Technical data</b>	<b>IEC</b>	<b>UL</b>	<b>CSA</b>
	EN 60 947-7-2	pending	pending
Cross section fine-stranded	0.2–4 mm <sup>2</sup>		
Cross section solid/stranded	0.2–4 mm <sup>2</sup>		
Cross section, AWG		24–12	24–12
Rated current			
Rated voltage	800 V*	600 V	600 V
Rated impulse voltage	8 kV		
Pollution degree	3		
<b>Accessories</b>			
	Type	Part No.	Std. Pack
End plate, gray	APFN 2,5 D2/2	07.312.7155.0	10
Partition, gray	TWFN 2,5 D2/2	07.312.7255.0	10

\* When cross connector IVB WKF 2,5-... is used, the rated voltage must be reduced to 630 V.



## Ground blocks with push-in connection

### WTP 6/10 PE

- Ground block with push-in connection for mounting on TS 35
- Nominal cross section 10 mm<sup>2</sup>

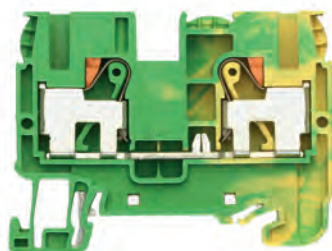

Description	Type	Part No.	Std. Pack
Ground block, green/yellow	WTP 6/10 PE	56.206.9055.0	100
<b>General data</b>			
Width / length / height, incl. TS 7.5	8 mm / 58 mm / 44 mm		
Wire strip length	15 mm		
Approvals			
<b>Technical data</b>			
	<b>IEC</b>	<b>UL</b>	<b>CSA</b>
	EN 60 947-7-2	pending	pending
Cross section fine-stranded	0.2–10 mm <sup>2</sup>		
Cross section solid/stranded	0.2–10 mm <sup>2</sup>		
Cross section, AWG	24–8		24–8
Rated current			
Rated voltage	1000 V*	600 V	600 V
Rated impulse voltage	8 kV		
Pollution degree	3		
<b>Accessories</b>			
	Type	Part No.	Std. Pack
End plate, gray	AP WTP 6/10	07.313.4155.0	10
Partition, gray	TW WTP 6/10	07.313.4255.0	10

\* When cross connector IVB WKFN 6-... is used, the rated voltage must be reduced to 800 V.

## Accessories for *fasis* WTP...

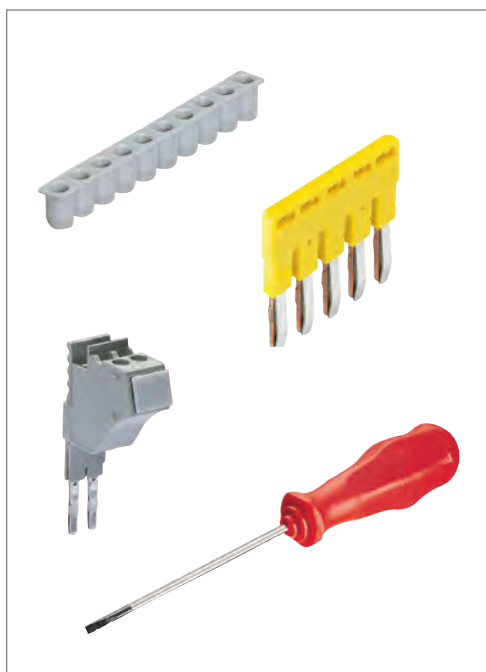

Accessories for WTP 2,5/4...		Type	Part No.	Std. Pack
Cross connector, insulated	2 pole	IVB WKF 2,5–2	Z7.280.6227.0	10
	3 pole	IVB WKF 2,5–3	Z7.280.6327.0	10
	4 pole	IVB WKF 2,5–4	Z7.280.6427.0	10
	5 pole	IVB WKF 2,5–5	Z7.280.6527.0	10
	6 pole	IVB WKF 2,5–6	Z7.280.6627.0	10
	7 pole	IVB WKF 2,5–7	Z7.280.6727.0	20
	8 pole	IVB WKF 2,5–8	Z7.280.6827.0	20
	9 pole	IVB WKF 2,5–9	Z7.280.6927.0	20
	10 pole	IVB WKF 2,5–10	Z7.280.7027.0	20
	20 pole	IVB WKF 2,5–20	Z7.280.8027.0	20
Wire entry guide	0.13–0.2 mm <sup>2</sup>	LELN 2,5/1 WEISS	05.564.3755.0	100
	0.25–0.5 mm <sup>2</sup>	LELN 2,5/2 GRAU	05.564.3855.0	100
	0.75–1.0 mm <sup>2</sup>	LELN 2,5/3 SCHWARZ	05.564.3955.0	100
Test adapter, modular		PS WKC/F	Z1.299.9753.0	10
Test plug		ST 2/2,3	Z5.553.2921.0	10
Screwdriver, uninsulated		DIN 5264 B 0,6x3,5	06.502.4000.0	5
Screwdriver, uninsulated, MINI		DIN 5264 B 0,6x3,5 M	06.502.5000.0	10
Accessories for WTP 6/10...		Type	Part No.	Std. Pack
Cross connector, insulated, I <sub>N</sub> : 41 A	2 pole	IVB WKFN 6–2	Z7.282.5227.0	10
(57 A when using	3 pole	IVB WKFN 6–3	Z7.282.5327.0	10
two cross connectors)	4 pole	IVB WKFN 6–4	Z7.282.5427.0	10
	5 pole	IVB WKFN 6–5	Z7.282.5527.0	10
Test plug		ST 2/2,3	Z5.553.2921.0	10
Screwdriver, uninsulated		DIN 5264 B 0,8x4	06.502.4100.0	5

## Multi-tier blocks with push-in connection

### WTP 2,5/4 E

- Multi-tier block with push-in connection for mounting on TS 35
- Nominal cross section 4 mm<sup>2</sup>

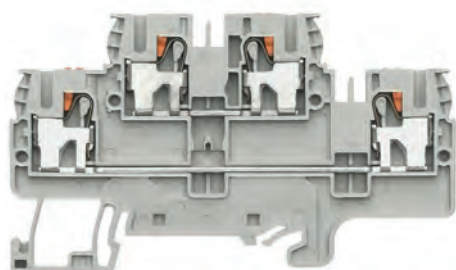

Description	Type	Part No.	Std. Pack
Multi-tier block, gray	WTP 2,5/4 E	56.203.7055.0	100
<b>General data</b>			
Width / length / height, incl. TS 7.5	5 mm / 82 mm / 48 mm		
Wire strip length	11 mm		
Approvals			
<b>Technical data</b>	<b>IEC</b>	<b>UL</b>	<b>CSA</b>
	EN 60 947-7-1	pending	pending
Cross section fine-stranded	0.2–4 mm <sup>2</sup>		
Cross section solid/stranded	0.2–4 mm <sup>2</sup>		
Cross section, AWG	24–12		
Rated current	24 A	20 A	20 A
Rated voltage	500 V	300 V	300 V
Rated impulse voltage	6 kV		
Pollution degree	3		
<b>Accessories</b>			
End plate, gray	APFN 2,5 E	07.312.7355.0	10
Partition, gray	TWFN 2,5 E	07.312.7455.0	10
Marking tag carrier, 2-fold	BT 5/2	04.243.0855.0	100

### WTP 2,5/4 E VB

- Multi-tier block, vertically connected, with push-in connection for mounting on TS 35
- Nominal cross section 4 mm<sup>2</sup>

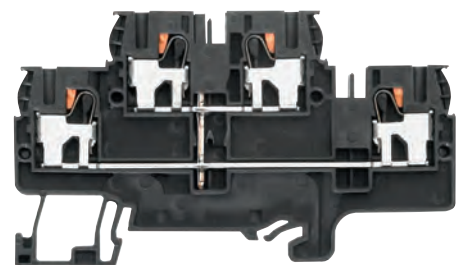

Description	Type	Part No.	Std. Pack
Multi-tier block, black	WTP 2,5/4 E VB	56.203.6955.1	100
<b>General data</b>			
Width / length / height, incl. TS 7.5	5 mm / 82 mm / 48 mm		
Wire strip length	11 mm		
Approvals			
<b>Technical data</b>	<b>IEC</b>	<b>UL</b>	<b>CSA</b>
	EN 60 947-7-2	pending	pending
Cross section fine-stranded	0.2–4 mm <sup>2</sup>		
Cross section solid/stranded	0.2–4 mm <sup>2</sup>		
Cross section, AWG	24–12		
Rated current	24 A	20 A	20 A
Rated voltage	500 V	300 V	300 V
Rated impulse voltage	6 kV		
Pollution degree	3		
<b>Accessories</b>			
End plate, gray	APFN 2,5 E	07.312.7355.0	10
Partition, gray	TWFN 2,5 E	07.312.7455.0	10
Marking tag carrier, 2-fold	BT 5/2	04.243.0855.0	100

### WTP 2,5/4 E PE

- Multi-tier ground block with push-in connection for mounting on TS 35
- Nominal cross section 4 mm<sup>2</sup>

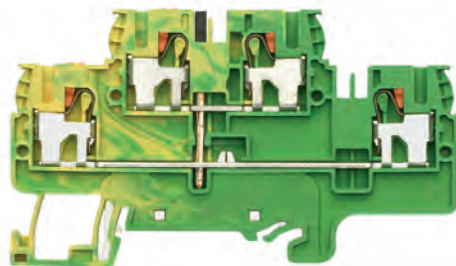

Description	Type	Part No.	Std. Pack
Multi-tier ground block, green/yellow	WTP 2,5/4 E PE	56.203.8955.0	100
<b>General data</b>			
Width / length / height, incl. TS 7.5	5 mm / 82 mm / 48 mm		
Wire strip length	11 mm		
Approvals			
<b>Technical data</b>	<b>IEC</b>	<b>UL</b>	<b>CSA</b>
	EN 60 947-7-2	pending	pending
Cross section fine-stranded	0.2–4 mm <sup>2</sup>		
Cross section solid/stranded	0.2–4 mm <sup>2</sup>		
Cross section, AWG	24–12		
Rated current	24 A		
Rated voltage	500 V	300 V	300 V
Rated impulse voltage	6 kV		
Pollution degree	3		
<b>Accessories</b>			
End plate, gray	APFN 2,5 E	07.312.7355.0	10

## Accessories for *fasis* WTP 2,5/4...

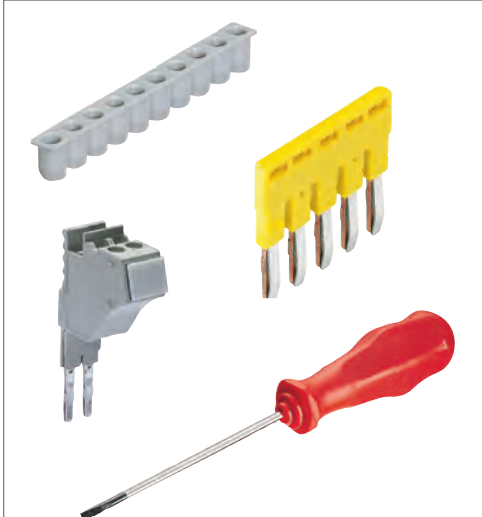
Accessories		Type	Part No.	Std. Pack	
	Cross connector, insulated	2 pole	IVB WKF 2,5-2	Z7.280.6227.0	10
		3 pole	IVB WKF 2,5-3	Z7.280.6327.0	10
		4 pole	IVB WKF 2,5-4	Z7.280.6427.0	10
		5 pole	IVB WKF 2,5-5	Z7.280.6527.0	10
		6 pole	IVB WKF 2,5-6	Z7.280.6627.0	10
		7 pole	IVB WKF 2,5-7	Z7.280.6727.0	20
		8 pole	IVB WKF 2,5-8	Z7.280.6827.0	20
		9 pole	IVB WKF 2,5-9	Z7.280.6927.0	20
		10 pole	IVB WKF 2,5-10	Z7.280.7027.0	20
		20 pole	IVB WKF 2,5-20	Z7.280.8027.0	20
	Vertical cross connector, insulated		IVB WKF V	Z7.261.1127.0	20
Wire entry guide	0.13-0.2 mm <sup>2</sup>		LELN 2,5/1 WEISS	05.564.3755.0	100
	0.25-0.5 mm <sup>2</sup>		LELN 2,5/2 GRAU	05.564.3855.0	100
	0.75-1.0 mm <sup>2</sup>		LELN 2,5/3 SCHWARZ	05.564.3955.0	100
Test adapter, modular			PS WKC/F	Z1.299.9753.0	10
Test plug			ST 2/2,3	Z5.553.2921.0	10
Screwdriver, uninsulated			DIN 5264 B 0,6x3,5	06.502.4000.0	5
Screwdriver, uninsulated, MINI			DIN 5264 B 0,6x3,5 M	06.502.5000.0	10

### Accessories



### Software



### Service

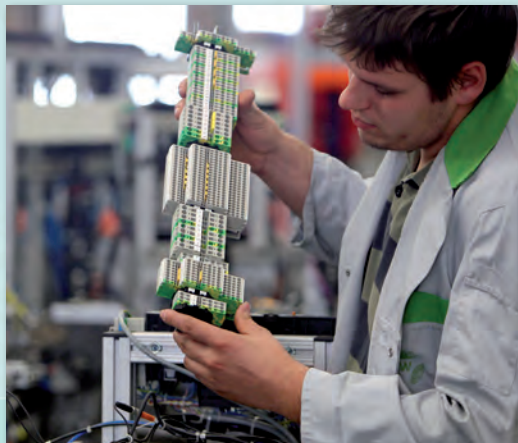

# Accessories and Service

To complement our products, we offer a comprehensive portfolio of accessories and services for terminal blocks.

Wieland offers a variety of product-specific accessories for its terminal blocks, for example covers and isolating plates as well as assembly materials such as mounting rails or tools for working with our products.

Marking solutions such as **wieplot** and **wiemarc** for DIN rail terminal blocks and other components in the control cabinet, the planning software **wieplan** for design of rail assemblies, and our value-add service for rail assemblies, all make working with Wieland DIN rail terminal blocks effortless, and achieve a true added value.



## Shielded cable terminal blocks, type WST – for trouble-free operation

High interference immunity is an important topic in industrial and process technology. It is one of the key factors affecting the availability of plants. For our **selos** and **fasis** terminal block series, we offer WST, a system that enables the cable shield to be connected to the housing earth in a simple, practical manner.

### Features

- Simple mounting - also if upgraded, service and maintenance
- Broad range - up to 32 mm cable diameter
- Top-quality, maintenance-free technology
- Various mounting options

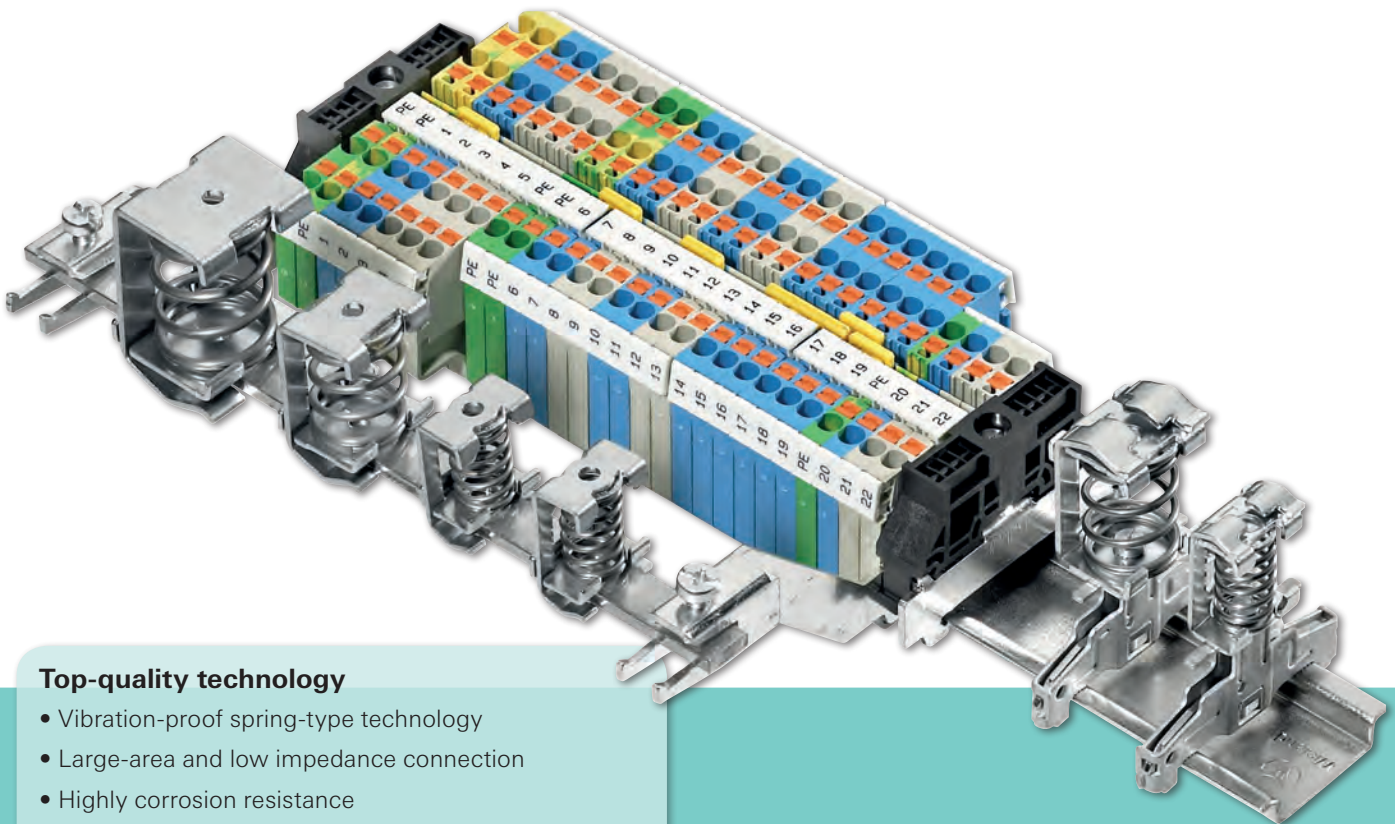
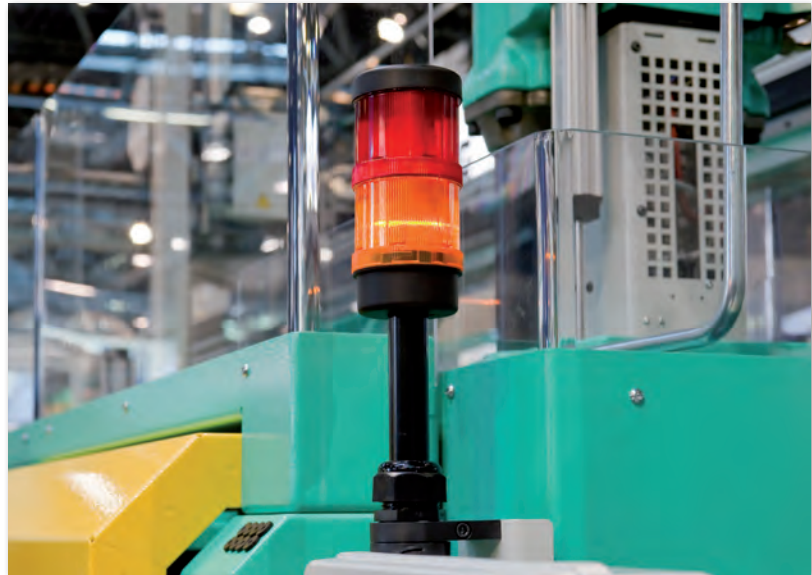

### Top-quality technology

- Vibration-proof spring-type technology
- Large-area and low impedance connection
- Highly corrosion resistance
- Durable clamping body from hardened steel

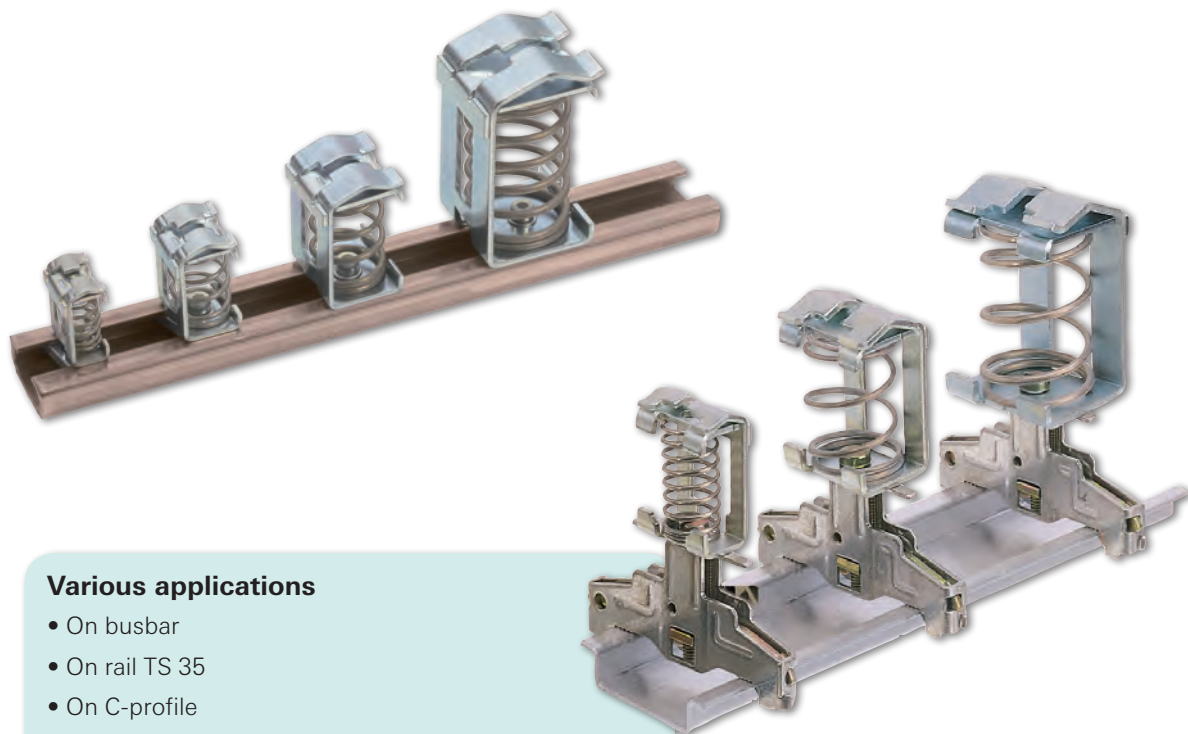

### Various applications

- On busbar
- On rail TS 35
- On C-profile
- With screw for mounting plates



### Various accessories

- Busbar support for TS 35
- Busbar support for insulated mounting
- Connection terminals



## Shielded cable terminals & accessories

**Shielded cable terminals *fasis* WST ...**

- for mounting on busbar 10 x 3 mm

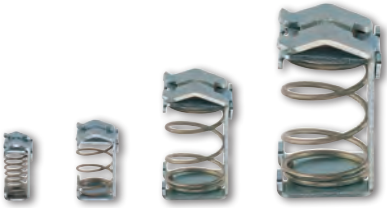

Description	Type	Part No.	Std. Pack	
<b>Shielded cable terminals <i>fasis</i></b>				
8 mm	WST 8	Z2.803.3010.0	10	
13.5 mm	WST 13,5	Z2.803.3110.0	10	
20 mm	WST 20	Z2.803.3210.0	10	
32 mm	WST 32	Z2.803.3310.0	10	
<b>Technical data</b>				
Width / length / height [mm]	<b>WST 8</b>	<b>WST 13.5</b>	<b>WST 20</b>	<b>WST 32</b>
	13 x 18 x 26	19 x 22 x 32	24 x 27 x 40	36 x 32 x 64
Connectible cable diameter	3 - 8 mm	4 - 13.5 mm	10 - 20 mm	15 - 32 mm

**Shielded cable terminals *fasis* WST C**

- for mounting on C-profile

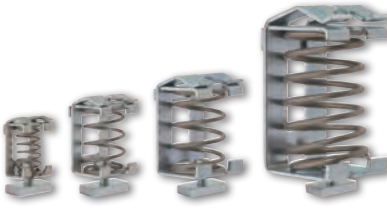

Description	Type	Part No.	Std. Pack	
<b>Shielded cable terminals <i>fasis</i></b>				
8 mm	WST 8 / C	Z2.803.4010.0	10	
13.5 mm	WST 13,5 / C	Z2.803.4110.0	10	
20 mm	WST 20 / C	Z2.803.4210.0	10	
32 mm	WST 32 / C	Z2.803.4310.0	10	
<b>Technical data</b>				
Width / length / height [mm]	<b>WST 8 / C</b>	<b>WST 13.5 / C</b>	<b>WST 20 / C</b>	<b>WST 32 / C</b>
	13 x 18 x 26	19 x 22 x 32	24 x 27 x 40	36 x 32 x 64
Connectible cable diameter	3 - 8 mm	4 - 13.5 mm	10 - 20 mm	15 - 32 mm
Mounting screw	M 4	M 4	M 4	M 4
<b>Accessories</b>				
Mounting rail, galvanized steel	L = 2 m	98.400.0000.0	1	
Mounting feet	light gray	Z1.980.0040.0	10	
Ground terminal for mounting rail	9700/10E/1	Z2.302.1321.0	10	

**Shielded cable terminals *fasis* WST D**

- for mounting on mounting plate



Description	Type	Part No.	Std. Pack	
<b>Shielded cable terminals <i>fasis</i></b>				
8 mm	WST 8 / D	Z2.803.5010.0	10	
13.5 mm	WST 13,5 / D	Z2.803.5110.0	10	
20 mm	WST 20 / D	Z2.803.5210.0	10	
32 mm	WST 32 / D	Z2.803.5310.0	10	
<b>Technical data</b>				
Width / length / height [mm]	<b>WST 8 / D</b>	<b>WST 13.5 / D</b>	<b>WST 20 / D</b>	<b>WST 32 / D</b>
	13 x 18 x 26	19 x 22 x 32	24 x 27 x 40	36 x 32 x 64
Connectible cable diameter	3 - 8 mm	4 - 13.5 mm	10 - 20 mm	15 - 32 mm
Mounting screw	M 4	M 4	M 4	M 4

**Shielded cable terminals *fasis* WST .../T35**

- for mounting on TS 35 mounting rail

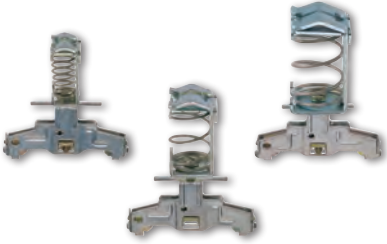

Description	Type	Part No.	Std. Pack
<b>Shielded cable terminals <i>fasis</i></b>			
8 mm	WST 8 / TS 35	Z2.803.6010.0	10
13.5 mm	WST 13,5 / TS 35	Z2.803.6110.0	10
20 mm	WST 20 / TS 35	Z2.803.6210.0	10
<b>Technical data</b>			
Width / length / height [mm]	<b>WST 8</b>	<b>WST 13.5</b>	<b>WST 20</b>
	13 x 52 x 54	19 x 52 x 60	24 x 52 x 68
Connectible cable diameter	3 - 8 mm	4 - 13.5 mm	10 - 20 mm



## Busbar support



Description	Type	Part No.	Std. Pack
<b>Busbar support</b>			
Busbar support (one-side), tin-plated steel	WE SH 1/35	Z5.515.3310.0	20
Busbar support (two-sided), tin-plated steel	WE SH 2/35	Z5.515.3410.0	20
Busbar support (two-sided), tin-plated steel	WE SH 3/35	Z5.519.0310.0	25
Busbar support (one-side), tin-plated steel	WE SH 4/35	Z5.519.0410.0	25
Busbar support plastic, black	WST H 10x3	Z1.980.0253.0	20

## Accessories



Description	Type	Part No.	Std. Pack
<b>Accessories</b>			
Ground Terminal, bright	WAK 35/2	30.494.4121.0	50
Ground Terminal, black	WAK 35/2 SW	30.494.4021.1	50
Busbar, Cu tin-plated copper	L = 1 m 9813M SN 10x3	98.290.1000.0	20

## Mounting rails

### Mounting rail 35x7,5 according to DIN EN 60715

- Length 2 m

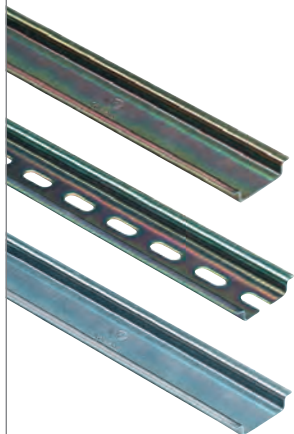

Description	Type	Part No.	Std. Pack
Steel, galv. zinc-plated and dichromated unslotted	35 x 27 x 7,5 EN 60715 2000mm	98.300.0000.0	1
Steel, galv. zinc-plated and dichromated slotted	35 x 27 x 7,5 EN 60715 2000mm	98.300.1000.0	1
Steel, unplated unslotted	35 x 27 x 7,5 EN 60715 2000mm	98.300.0010.0	1

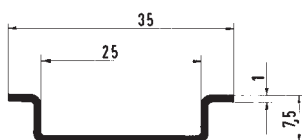

### Mounting rail 35x15 according to DIN EN 60715

- Length 1 m/2 m

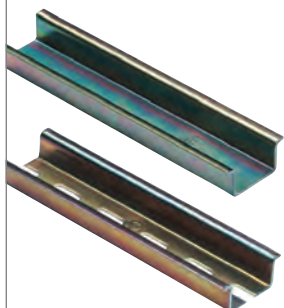

Description	Type	Part No.	Std. Pack
Steel, galv. zinc-plated and dichromated unslotted	35 x 27 x 15 EN 60715 2000mm	98.370.0000.0	1
Steel, galv. zinc-plated and dichromated slotted	35 x 27 x 15 EN 60715 2000mm	98.370.1000.0	1
Steel, galv. zinc-plated and dichromated slotted	35 x 27 x 15 EN 60715 1000mm	98.375.1000.0	10
Steel, V2A slotted	35 x 27 x 15 EN 60715 2000mm	98.370.1001.0	1

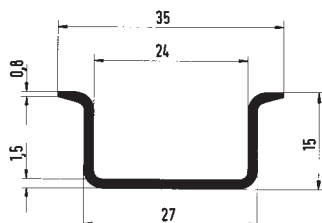

### Mounting rail 35x15 according to DIN EN 60715

- Length 2 m

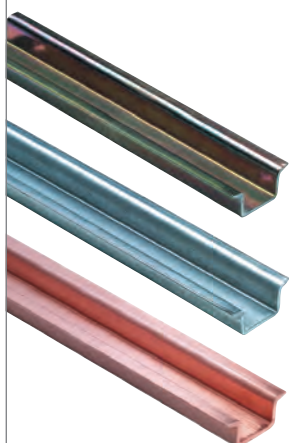

Description	Type	Part No.	Std. Pack
Steel, galv. zinc-plated and dichromated unslotted	35 x 24 x 15 EN 60715 2000mm	98.360.0000.0	1
Steel, hot-galvanized unslotted	35 x 24 x 15 EN 60715 ZN 2000mm	98.360.0004.0	1
E-copper unslotted	35 x 24 x 15 EN 60715 CU 2000mm	98.380.0000.0	10

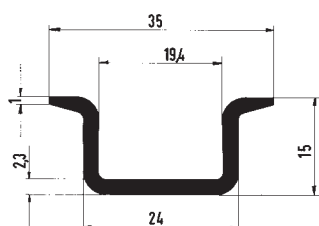

**Mounting rail 15x5,5 according to DIN EN 60715**

- Length 1 m/2 m

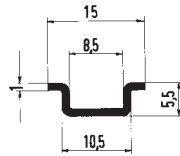
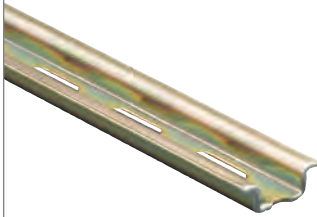

Description	Type	Part No.	Std. Pack
Steel, galv. zinc-plated and dichromated unslotted	9021 / 15 x 5,5 EN 60715 2000mm	98.090.0015.0	10
Steel, galv. zinc-plated and dichromated slotted	9021 / 15 x 5,5 EN 60715 1000mm	98.090.0000.0	1

**Mounting rail 15x5,5 according to DIN EN 60715**

- Length 2 m

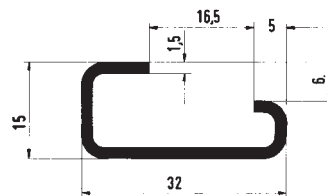
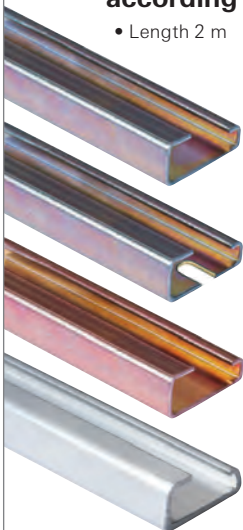

Description	Type	Part No.	Std. Pack
Steel, galv. zinc-plated and dichromated unslotted	9006 EN 60715 G-32 2000mm	98.190.0000.0	1
Steel, galv. zinc-plated and dichromated slotted	9006 EN 60715 G-32 2000mm	98.190.1000.0	1
E-copper unslotted	9006 E-CU 2000mm	98.220.0000.0	10
Aluminium unslotted	9006 AL 2000mm	98.210.0000.0	1

**Accessories**

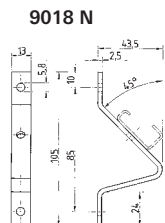
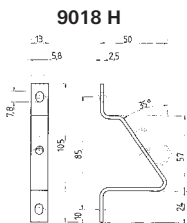
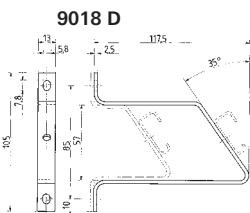

Accessories	Type	Part No.	Std. Pack
Angled support bracket with mounting material	9018 D	Z5.516.2511.0	50
Angled support bracket with mounting material	9018 H	Z5.516.2711.0	50
Angled support bracket with mounting material	9018 N	Z5.516.2811.0	50

## End clamps

### End clamp for TS 35 snap-on mounting

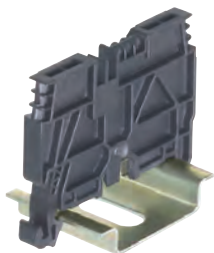

Description	Type	Part No.	Std. Pack
End clamp TS 35 5 mm wide	WEF 2 /35	Z5.523.9453.0	100

### End clamp for TS 35 snap-on mounting

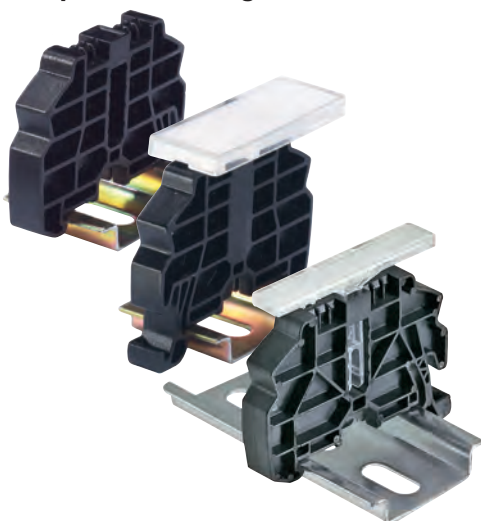

Description	Type	Part No.	Std. Pack
End clamp TS 35 8 mm wide	WEF 1 /35	Z5.523.9353.0	100
End clamp TS 35 17,5 mm wide with marking facilities	WEF 1 BS /35	69.920.1053.0	100
End clamp TS 35 8 mm wide with marking facilities	WEF 1 BSS /35	69.920.1253.0	100
<b>Accessories</b>			
Marking tag for WEF 1 /35 wide	BS/R	Z4.243.8453.0	100
Marking cardboard in perforated sheets 100 tags/sh.		04.019.0289.0	10
Marking tag for WEF 1 /35 small		04.243.8550.0	10
Marking cardboard in perforated sheets small		04.019.1189.0	10

### End clamp for TS 35 screw mounting



Description	Type	Part No.	Std. Pack
End clamp TS 35 8 mm wide	9708/2 S 35	Z5.522.8553.0	100
End clamp TS 35 17,5 mm wide	9708/2 BS 35	69.920.0553.0	100
<b>Accessories</b>			
Marking cardboard in perforated sheets 100 tags/sh.		04.019.0289.0	10

## End clamp with with U-foot screw mounting

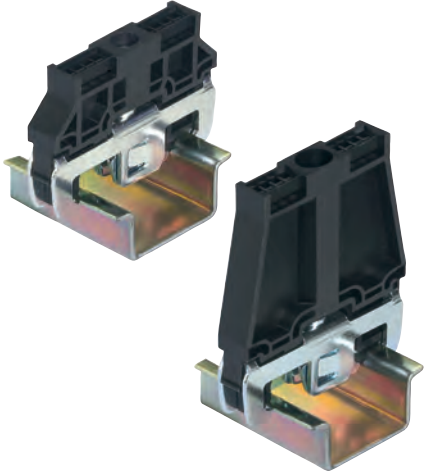

Description	Type	Part No.	Std. Pack
End clamp with U-foot 10 mm wide	WE 1 /U	Z5.523.5753.0	100
End clamp with U-foot 17,5mm wide with marking facilities	WE 1 BS /U	69.920.0753.0	100
End clamp with U-foot 10 mm wide	WE 2 /U	Z5.523.5653.0	100
End clamp with U-foot 17,5 mm wide with marking facilities	WE 2 BS /U	69.920.0653.0	100
<b>Accessories</b>			
Marking cardboard in perforated sheets 100 tags/sh.		04.019.0289.0	10

## End clamp for TS 15 screw mounting



Description	Type	Part No.	Std. Pack
End clamp, plastic 7,5 mm wide	9208 S 15	Z5.522.7553.0	100
End clamp, steel 5 mm wide	9222 S 15	Z5.522.5010.0	100

## Configuration and marking systems

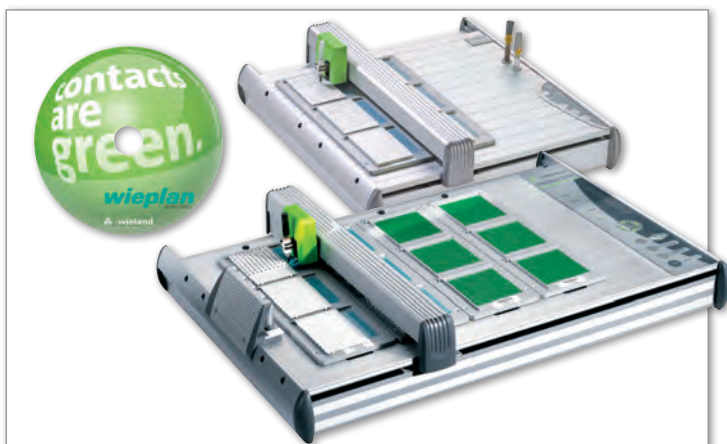

Individual marking of DIN rail terminal blocks means **wiemarc** and **wieplot** at Wieland Electric. The **wiemarc** software was developed to provide you with maximum flexibility in marking your terminal block assemblies. Together with the **wieplot** plotter you have a powerful marking system that enables you to work professionally from the individual marking tag to series marking of your terminal block assemblies. You feel confident with the system due to its easy handling and visual representation of your marking, even when you use it for the first time.

But **wieplot** offers even more!

In addition to the marking tags for DIN rail terminal blocks you can also print self-adhesive tags and labels or cable markings. A slight modification can even make your plotter a powerful engraving system.

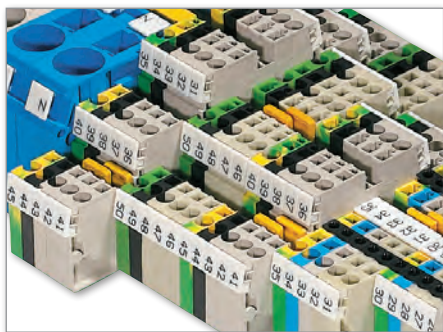

### **selos – fasis**

#### **Marking with a system**

- Individual marking of all terminal blocks for clear wire/termination point assignment
- One single marking system for all designs
- Marking of individual tags; marking strips that correspond to the exact widths of the terminal blocks; or group markings
- Individual planning of terminal block assemblies and markings with **wieplan**

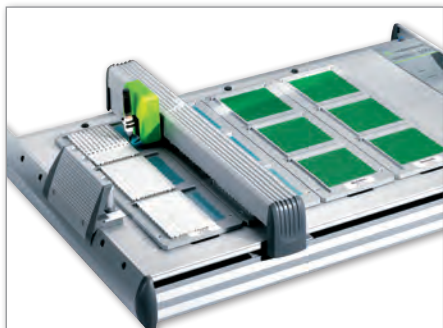

### **wieplot**

#### **Ready for universal use**

- Marks all common marking systems available for DIN rail terminal blocks
- Different marking tags can be marked individually in one single work step
- Marking of labels, self-adhesive tags and cables is possible

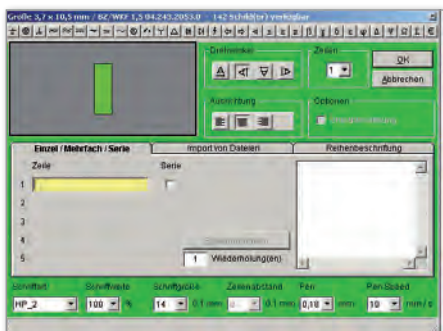

### **wiemarc**

#### **Easy and quick**

- Simple and intuitive user interface
- Direct graphical display of the marking tags including plausibility check
- Customized layouts can be created individually
- Data import from CAD, Excel, text or **wieplan** files

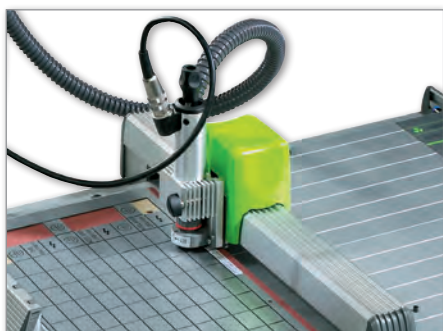

### **wieplot engraving system**

#### **Durable and safe – wieplot engraving system**

- Easy modification to **wieplot** to make it an engraving system
- Engraving of multi-layer plastic boards
- Clean and dust-proof operation due to integrated vacuum device
- Create individual layouts using **wiemarc**

## Plotter system *wieplot*

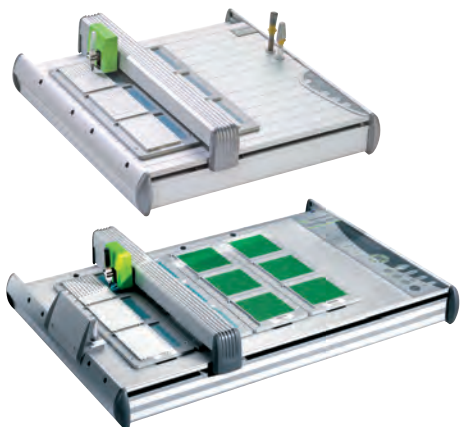

Description	Type	Part No.	Std. Pack
Complete package	wieplot BASIC	95.502.0607.0	1
Complete package	wieplot 500	95.502.0604.0	1

**Contents:** Plotter *wieplot*, data cable and manual, 4 receptacles (*wieplot*<sup>500</sup>) / 2 receptacles (*wieplot*<sup>BASIC</sup>) for WSB (Wieland standard marking system), accessories kit, *wiemarc* software

### Description:

With *wiemarc* you can create customized marking data on your PC. These can then be output on the *wieplot* plotter system to various marking plates.

Technical data	
Resolution	0.01 mm
Accuracy	+/- 0.05 mm
Power supply unit	50/60 Hz, 100-240V
Output voltage	24VDC 1.4A
Current input	app. 0.3A at 220V
Approval	UL-UL1950, CSA 950, VDE EN60950
Radio interf. suppr.	FCC class B, FCC sect. 15 and VDE class B
Dimension / Weight – <i>wieplot</i> <sup>BASIC</sup>	440 mm x 440 mm x 125 mm / 6 kg
Dimension / Weight – <i>wieplot</i> <sup>500</sup>	660 mm x 440 mm x 125 mm / 8 kg
Interfaces	USB Level 1.1., parallel

## Accessories for *wieplot*



Plotter pens for <i>wieplot</i>	Part No.	Type	Part No.
Plotter pen 0.18 mm	95.502.0118.0	Ink cartridge P2.0, 5x1ml	95.502.0199.0
Plotter pen 0.25 mm	95.502.0125.0	Cleaning set	95.502.0198.0
Plotter pen 0.35 mm	95.502.0135.0	Pen cleaner	95.502.0197.0
Plotter pen 0.50 mm	95.502.0150.0	Dust protection hood	95.502.0612.0
Plotter pen 0.70 mm	95.502.0170.0	Service kit – pen station	95.502.0613.0
Plotter pen 1.00 mm	95.502.0100.0	Seal inserts kit	
Dispos plotter pen 0.25 mm	95.502.0125.1		
Dispos plotter pen 0.35 mm	95.502.0135.1		
Dispos plotter pen-D ED 0.25 mm	95.502.0225.1		
Dispos plotter pen-D ED 0.35 mm	95.502.0235.1		

Receptacles for marking plates	
Type	Part No.
Receptacle for WSB	95.502.0620.0
Receptacle for BZ/WKF 15,	95.502.0627.0
Receptacle for BZ/WKF 1,5/10	95.502.0628.0

## Engraving unit for *wieplot*<sup>500</sup>



Description	Type	Part No.	Std. Pack
Engraving unit	wieplot 500 E-UNIT	95.502.0700.0	1

**Contents:** Engraving spindle, engraving head (with fuse and counter bearing), control unit *wieplot* <sup>vec</sup> 500, vacuum cleaner *wieplot* <sup>vc</sup> 500, connection cables

### Description:

The *wieplot* 500 E-UNIT engraving unit has been designed for use with the *wieplot* 500 plotter. The system is set up for engraving multi-layer plastic tags. The Plotboard A4 in a 297 x 202 mm format is the receptacle for marking paper sheets and labels and also enables engraving of plastic boards.

Accessories	Type	Part No.	Std. Pack
Graver SET, complete	SET	95.502.0710.0	1
Graver	0.2 mm	95.502.0710.2	1
Graver	0.3 mm	95.502.0710.3	1
Graver	0.4 mm	95.502.0710.4	1
Graver	0.5 mm	95.502.0710.5	1
Graver	0.7 mm	95.502.0710.7	1
Graver	1.0 mm	95.502.0711.0	1
Receptacle	Plotboard A4	95.502.0625.0	1

# Marking accessories

## Marking plates

• For **wieplot**BASIC / **wieplot**500 plotter system



Description	Type	Part No.	Std. Pack
<b>Unmarked</b>			
Width 4 x 5 mm	100 tags per plate	9075/4/10/10	Z4.243.2053.0 10
Width 5 x 8.3 mm	110 tags per plate	9075 A/5/10/11	Z4.242.5053.0 10
Width 5 x 14 mm	60 tags per plate	9075 AL/5/10/6	Z4.242.5153.0 10
Width 6 x 8.3 mm	110 tags per plate	9075 A/6/10/11	Z4.242.6053.0 10
Width 6 x 14 mm	60 tags per plate	9075 AL/6/10/6	Z4.242.6353.0 10
Width 8 x 8.3 mm	70 tags per plate	9075 A/8/10/7	Z4.242.8053.0 10

## Single marking tag All blocks/ 5 mm wide and larger

\*) Custom marking upon request



Description	Type	Part No.	Std. Pack
<b>Unmarked</b>			
Width 5 x 8.3 mm	9705 A	04.242.0850.0	500
Width 5 x 14 mm	9705 AL	04.242.1553.0	500
<b>Marked</b>			
Width 5 x 8.3 mm	9705 AB *)	04.842.0850.0	500
Width 5 x 14 mm	9705 ALB *)	04.842.1553.0	500

## Marking strips 1.5 mm<sup>2</sup>/4 mm wide

\*) Custom marking upon request



Description	Type	Part No.	Std. Pack
<b>Marking strips for center block marking</b>			
Unmarked	9705 A 4/10	04.243.2053.0	100
Marked	9705 A 4/10 B *)	04.843.2053.0	25
<b>Marking strips for outer block marking</b>			
Marked	9705 A 4/10/10	Z4.243.2053.0	10

## Marking strips 2.5 mm<sup>2</sup>/5 mm wide

\*) Custom marking upon request



Description	Type	Part No.	Std. Pack
<b>Unmarked</b>			
	9705 A/5/10	04.242.5053.0	25
<b>Marked</b>			
1 - 9	9705A/5/10 B 1 - 9	04.842.4953.0	25
*)	9705A/5/10 B	04.842.5053.0	25
1 - 10	9705A/5/10 B 1 - 10	04.845.0153.0	25
11 - 20	9705A/5/10 B 11 - 20	04.845.0253.0	25
21 - 30	9705A/5/10 B 21 - 30	04.845.0353.0	25
31 - 40	9705A/5/10 B 31 - 40	04.845.0453.0	25
41 - 50	9705A/5/10 B 41 - 50	04.845.0553.0	25
51 - 60	9705A/5/10 B 51 - 60	04.845.0653.0	25
61 - 70	9705A/5/10 B 61 - 70	04.845.0753.0	25
71 - 80	9705A/5/10 B 71 - 80	04.845.0853.0	25
81 - 90	9705A/5/10 B 81 - 90	04.845.0953.0	25
91 - 100	9705A/5/10 B 91 - 100	04.845.1053.0	25
⊕ (10x)	9705A/5/10B SLZ	04.855.0053.0	25
⊖ (10x)	9705A/5/10B ERDZ	04.855.0153.0	25
+	9705A/5/10 B +	04.855.0253.0	25
-	9705A/5/10 B -	04.855.0353.0	25
L1 (10x)	9705A/5/10B L1	04.855.0453.0	25
L2 (10x)	9705A/5/10B L2	04.855.0553.0	25
L3 (10x)	9705A/5/10B L3	04.855.0653.0	25
PE (10x)	9705A/5/10B PE	04.855.0753.0	25
SL (10x)	9705A/5/10B SL	04.855.3153.0	25
N (10x)	9705A/5/10B N	04.855.3253.0	25
F1 (10x)	9705A/5/10B F1	04.855.0953.0	25
F2 (10x)	9705A/5/10B F2	04.855.1053.0	25
L1, L2, L3, N, PE (10x)	9705A/5/10B L1L2L3NPE..	04.855.0853.0	25
<b>With enlarged marking area</b>	9705 AL/5/10	04.242.5153.0	25



**Marking strips  
4 mm<sup>2</sup>/6 mm wide**

\*) Custom marking upon request



Description	Type	Part No.	Std. Pack
<b>Unmarked</b>	9705 A/6/10	04.242.6053.0	25
<b>Marked</b>			
1 – 9	9705A/6/9 B 1 - 9	04.842.5953.0	25
*)	9705A/6/10 B	04.842.6053.0	25
1 – 10	9705A/6/10 B 1 - 10	04.846.0153.0	25
11 – 20	9705A/6/10 B 11 - 20	04.846.0253.0	25
21 – 30	9705A/6/10 B 21 - 30	04.846.0353.0	25
31 – 40	9705A/6/10 B 31 - 40	04.846.0453.0	25
41 – 50	9705A/6/10 B 41 - 50	04.846.0553.0	25
51 – 60	9705A/6/10 B 51 - 60	04.846.0653.0	25
61 – 70	9705A/6/10 B 61 - 70	04.846.0753.0	25
71 – 80	9705A/6/10 B 71 - 80	04.846.0853.0	25
81 – 90	9705A/6/10 B 81 - 90	04.846.0953.0	25
91 – 100	9705A/6/10 B 91 - 100	04.846.1053.0	25
⊕ (10x)	9705A/6/10 B SLZ	04.856.0053.0	25
⊖ (10x)	9705A/6/10 B ERDZ	04.856.0153.0	25
+ (10x)	9705A/6/10 B +	04.856.0253.0	25
- (10x)	9705A/6/10 B -	04.856.0353.0	25
L1 (10x)	9705A/6/10 B L1	04.856.0453.0	25
L2 (10x)	9705A/6/10 B L2	04.856.0553.0	25
L3 (10x)	9705A/6/10 B L3	04.856.0653.0	25
PE (10x)	9705A/6/10 B PE	04.856.0753.0	25
SL (10x)	9705A/6/10 B SL	04.856.3153.0	25
N (10x)	9705A/6/10 B N	04.856.3253.0	25
F1 (10x)	9705A/6/10 B F1	04.856.0953.0	25
F2 (10x)	9705A/6/10 B F2	04.856.1053.0	25
L1,L2,L3,N,PE (10x)	9705A/6/10 B L1L2L3NPE..	04.856.0853.0	25
<b>With enlarged marking area</b>	9705 AL/6/10	04.242.6353.0	25

**Marking strips  
6 mm<sup>2</sup>/8 mm wide**

\*) Custom marking upon request



Description	Type	Part No.	Std. Pack
<b>Unmarked</b>	9705 A/8/10	04.242.8053.0	25
<b>Marked</b>			
1 – 9	9705A/8/9 B 1 - 9	04.842.7953.0	25
*)	9705A/8/10 B	04.842.8053.0	25
1 – 10	9705A/8/10 B 1 - 10	04.848.0153.0	25
11 – 20	9705A/8/10 B 11 - 20	04.848.0253.0	25
21 – 30	9705A/8/10 B 21 - 30	04.848.0353.0	25
31 – 40	9705A/8/10 B 31 - 40	04.848.0453.0	25
41 – 50	9705A/8/10 B 41 - 50	04.848.0553.0	25
51 – 60	9705A/8/10 B 51 - 60	04.848.0653.0	25
61 – 70	9705A/8/10 B 61 - 70	04.848.0753.0	25
71 – 80	9705A/8/10 B 71 - 80	04.848.0853.0	25
81 – 90	9705A/8/10 B 81 - 90	04.848.0953.0	25
91 – 100	9705A/8/10 B 91 - 100	04.848.1053.0	25
⊕ (10x)	9705A/8/10 B SLZ	04.858.0053.0	25
⊖ (10x)	9705A/8/10 B ERDZ	04.858.0153.0	25
+ (10x)	9705A/8/10 B +	04.858.0253.0	25
- (10x)	9705A/8/10 B -	04.858.0353.0	25
L1 (10x)	9705A/8/10 B L1	04.858.0453.0	25
L2 (10x)	9705A/8/10 B L2	04.858.0553.0	25
L3 (10x)	9705A/8/10 B L3	04.858.0653.0	25
PE (10x)	9705A/8/10 B PE	04.858.0753.0	25
SL (10x)	9705A/8/10 B SL	04.858.3153.0	25
N (10x)	9705A/8/10 B N	04.858.3253.0	25
F1 (10x)	9705A/8/10 B F1	04.858.0953.0	25
F2 (10x)	9705A/8/10 B F2	04.858.1053.0	25
L1,L2,L3,N,PE (10x)	9705A/8/10 B L1L2L3NPE..	04.858.0853.0	25

**Marking strips  
10 mm<sup>2</sup>/10 mm wide  
16 mm<sup>2</sup>/12 mm wide  
35 mm<sup>2</sup>/16 mm wide  
70 mm<sup>2</sup>/24 mm wide**



Description	Type	Part No.	Std. Pack
<b>10 mm<sup>2</sup>/10 mm wide</b> for 5 blocks	9705 A/5/10/5 B	04.842.5553.0	25
<b>16 mm<sup>2</sup>/12 mm wide</b> for 5 blocks	9705 A/6/10/5 B	04.842.6553.0	25
<b>35 mm<sup>2</sup>/16 mm wide</b> for 5 blocks	9705 A/8/10/5 B	04.842.8553.0	25
<b>70 mm<sup>2</sup>/24 mm wide</b> for 4 blocks	9705 A/8/10/5 B	04.842.8553.0	25

Specify required marking with part no.

## Marking accessories

### Tear-off marking strips marked with numbers

- With 10 marking tags
- For single symbol marking



Description	Type	Part No.	Std. Pack
<b>Unmarked</b>	9704 A	04.241.1150.0	25
<b>Marked with the same number</b>			
1	9704 A/1 B	04.841.1150.0	25
2	9704 A/2 B	04.841.1250.0	25
3	9704 A/3 B	04.841.1350.0	25
4	9704 A/4 B	04.841.1450.0	25
5	9704 A/5 B	04.841.1550.0	25
6	9704 A/6 B	04.841.1650.0	25
7	9704 A/7 B	04.841.1750.0	25
8	9704 A/8 B	04.841.1850.0	25
9	9704 A/9 B	04.841.1950.0	25
0	9704 A/0 B	04.841.2050.0	25
<b>Marked with consecutive numbers</b>			
1-0	9704 A/1-0 B	04.841.2150.0	25
<b>Marked with the same symbols</b>			
+	9704 A/+	04.841.7450.0	25
-	9704 A/-	04.841.7550.0	25
/	9704 A//	04.841.7650.0	25
.	9704 A/.	04.841.7750.0	25
<b>Set, marked with same numbers (= 10 x 25 strips = 2.500 numbers)</b>			
111 up to 000		04.841.9050.0	1

### Tear-off marking strips marked with upper case letters

- With 10 marking tags
- For single symbol marking



Description	Type	Part No.	Std. Pack
<b>Marked with the same upper case letters</b>			
A	9704 A /AG B	04.841.2250.0	25
B	9704 A /BG B	04.841.2350.0	25
C	9704 A /CG B	04.841.2450.0	25
D	9704 A /DG B	04.841.2550.0	25
E	9704 A /EG B	04.841.2650.0	25
F	9704 A /FG B	04.841.2750.0	25
G	9704 A /GG B	04.841.2850.0	25
H	9704 A /HG B	04.841.2950.0	25
I	9704 A /IG B	04.841.3050.0	25
J	9704 A /JG B	04.841.3150.0	25
K	9704 A /KG B	04.841.3250.0	25
L	9704 A /LG B	04.841.3350.0	25
M	9704 A /MG B	04.841.3450.0	25
N	9704 A /NG B	04.841.3550.0	25
O	9704 A /OG B	04.841.3650.0	25
P	9704 A /PG B	04.841.3750.0	25
Q	9704 A /QG B	04.841.3850.0	25
R	9704 A /RG B	04.841.3950.0	25
S	9704 A /SG B	04.841.4050.0	25
T	9704 A /TG B	04.841.4150.0	25
U	9704 A /UG B	04.841.4250.0	25
V	9704 A /VG B	04.841.4350.0	25
W	9704 A /WG B	04.841.4450.0	25
X	9704 A /XG B	04.841.4550.0	25
Y	9704 A /YG B	04.841.4650.0	25
Z	9704 A /ZG B	04.841.4750.0	25
<b>Set, marked with same upper case letters (= 26 x 25 strips = 6.500 numbers)</b>			
A up to Z GB		04.841.9150.0	1

### Tear-off marking strips marked with lower case letters

- With 10 marking tags
- For single symbol marking



Description	Type	Part No.	Std. Pack
<b>Marked with the same lower case letters</b>			
a	9704 A /AK B	04.841.4850.0	25
b	9704 A /BK B	04.841.4950.0	25
c	9704 A /CK B	04.841.5050.0	25
d	9704 A /DK B	04.841.5150.0	25
e	9704 A /EK B	04.841.5250.0	25
f	9704 A /FK B	04.841.5350.0	25
g	9704 A /GK B	04.841.5450.0	25
h	9704 A /HK B	04.841.5550.0	25
i	9704 A /IK B	04.841.5650.0	25
j	9704 A /JK B	04.841.5750.0	25
k	9704 A /KK B	04.841.5850.0	25
l	9704 A /LK B	04.841.5950.0	25
m	9704 A /MK B	04.841.6050.0	25
n	9704 A /NK B	04.841.6150.0	25
o	9704 A /OK B	04.841.6250.0	25
p	9704 A /PK B	04.841.6350.0	25
q	9704 A /QK B	04.841.6450.0	25
r	9704 A /RK B	04.841.6550.0	25
s	9704 A /SK B	04.841.6650.0	25
t	9704 A /TK B	04.841.6750.0	25
u	9704 A /UK B	04.841.6850.0	25
v	9704 A /VK B	04.841.6950.0	25
w	9704 A /WK B	04.841.7050.0	25
x	9704 A /XK B	04.841.7150.0	25
y	9704 A /YK B	04.841.7250.0	25
z	9704 A /ZK B	04.841.7350.0	25
<b>Set, Marked with the same lower case letters (= 26 x 25 strips = 6.500 numbers)</b>			
a up to z KB		04.841.9250.0	1

Assortment box	Description				Type	Part No.	Std. Pack	
	<ul style="list-style-type: none"> <li>For marking material</li> </ul>	<b>Assortment box for 5 mm width</b>				S0 1/5	04.900.2053.0	1
Assortment for 5 mm width				1-100	9705 A/5/10 B	04.855.1153.0	1	
				101-200	9705 A/5/10 B	04.855.1253.0	1	
<b>Assortment box for 6 mm width</b>				S0 1/6	04.900.3053.0	1		
Assortment for 6 mm width				1-100	9705 A/6/10 B	04.856.1153.0	1	
				101-200	9705 A/6/10 B	04.856.1253.0	1	
<b>Assortment box for 8 mm width</b>				S0 1/8	04.900.4053.0	1		
Assortment for 8 mm width				1-100	9705 A/8/10 B	04.858.1153.0	1	
				101-200	9705 A/8/10 B	04.858.1253.0	1	
<b>Assortment box for tear-off marking tags</b>								
with 50 digits each				S0 1/0	04.900.1053.0	1		
<b>Assortment box, empty</b>				S0 1	04.900.0000.0	1		

Marking tag carrier	Description				Type	Part No.	Std. Pack
	<ul style="list-style-type: none"> <li>For all blocks</li> </ul>	<b>Marking tag carrier, 4 digits</b>				9705 A/4	04.242.0950.0
<b>Marking tag carrier, 6 digits</b>				9705 A/6	04.242.1250.0	200	
<b>Marking tag carrier, 45° angle</b>				9705 A/4 W	04.242.2853.0	200	



Partition	Description				Type	Part No.	Std. Pack
	<ul style="list-style-type: none"> <li>With marking facilities</li> </ul>	<b>Partition with carrier for marking tags</b>					
for TS32 and TS35					Z7.311.1755.0	10	
for TS15					Z7.311.2755.0	10	
<b>Partition with carrier for marking cards</b>							
for TS32 and TS35					Z7.311.7055.0	10	
<b>Accessories</b>							
Marking card in perforated sheets				100 tags/sheets		04.019.0289.0	10



## Cross connectors and jumper bars

### Cross connectors

- Cross connector poles can be individually removed.
- When cross connectors with removed poles are used, the rated voltage is reduced to 400 V.
- You can cut a 10-wire connector plug in half to form two 5-wire connector plugs, but an end cover plate or isolating plate must then be inserted.



Description	Type	Part No.	Std. Pack
<b>1.5 mm<sup>2</sup>, 4 mm wide</b>	IVB WKF 1,5-2	Z7.268.0227.0	10
	IVB WKF 1,5-3	Z7.268.0327.0	10
	IVB WKF 1,5-4	Z7.268.0427.0	10
	IVB WKF 1,5-5	Z7.268.0527.0	10
	IVB WKF 1,5-10	Z7.268.1027.0	10
	IVB WKF 1,5-20	Z7.268.2027.0	10
<b>2.5 mm<sup>2</sup>, 5 mm wide</b>	IVB WKF 2,5-2	Z7.280.6227.0	10
	IVB WKF 2,5-3	Z7.280.6327.0	10
	IVB WKF 2,5-4	Z7.280.6427.0	10
	IVB WKF 2,5-5	Z7.280.6527.0	10
	IVB WKF 2,5-6	Z7.280.6627.0	10
	IVB WKF 2,5-7	Z7.280.6727.0	20
	IVB WKF 2,5-8	Z7.280.6827.0	20
	IVB WKF 2,5-9	Z7.280.6927.0	20
	IVB WKF 2,5-10	Z7.280.7027.0	20
	IVB WKF 2,5-20	Z7.280.8027.0	20
	IVB WKF-V	Z7.261.1127.0	10
	<b>4 mm<sup>2</sup>, 6 mm wide</b>	IVB WKF 4-2	Z7.261.1227.0
IVB WKF 4-3		Z7.261.1327.0	10
IVB WKF 4-4		Z7.261.1427.0	10
IVB WKF 4-5		Z7.261.1527.0	10
IVB WKF 4-6		Z7.261.1627.0	10
IVB WKF 4-7		Z7.261.1727.0	10
IVB WKF 4-8		Z7.261.1827.0	10
IVB WKF 4-9		Z7.261.1927.0	10
IVB WKF 4-10		Z7.261.2027.0	10
<b>6 mm<sup>2</sup>, 8 mm wide</b>		IVB WKF 6-2	Z7.282.5227.0
	IVB WKF 6-5	Z7.282.5527.0	10
<i>I<sub>N</sub></i> : 41 A (57 A when using two cross connectors)			
<b>10 mm<sup>2</sup>, 10 mm wide</b>	IVB WKF 10-2	Z7.283.8227.0	10
<b>16 mm<sup>2</sup>, 12 mm wide</b>	IVB WKF 16-2	Z7.284.4227.0	10
<b>35 mm<sup>2</sup>, 16 mm wide</b>	IVB WKF 35-2	Z7.285.6227.0	10
	IVB WKF 35R10-2	Z7.285.6427.0	10
<b>Jumping cross connectors for WT 2,5, WTP 2,5/4 and WKF 2,5</b>			
3 pole 1-3		99.013.9999.9	10
4 pole 1-4		99.014.9999.9	10
5 pole 1-5		99.015.9999.9	10
5 pole 1 to 3 to 5		99.031.9999.9	10
7 pole 1 to 3, 5 and 7		99.032.9999.9	10
9 pole 1 to 3, 5, 7 and 9		99.033.9999.9	10
11 pole 1 to 3, 5, 7, 9 and 11		99.034.9999.9	10
Additional combinations upon request			

### Jumper bar, insulated Jumper comb, insulated

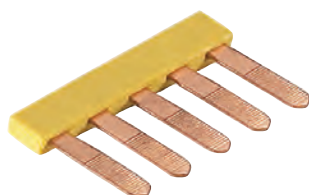

Description	Type	Part No.	Std. Pack
<b>WK 4/U and WK 4 TK, 6mm wide, 0.5mm thick</b>			
Jumper comb, insulated	IVB 0,5 WK 4-2	Z7.255.0227.0	10
	IVB 0,5 WK 4-12	Z7.255.0227.0	10
<b>WK 4/U and WK 4 TK, 6mm wide, 1mm thick</b>			
Jumper comb, insulated	IVB 1 WK 4-2	Z7.255.4227.0	10
	IVB 1 WK 4-12	Z7.255.4227.0	10
<b>WK 6, WKN 6 TK, WK 4 THSi 6,3x32</b>			
Jumper comb, insulated	IVK WKN 6 TK-2	Z7.255.8227.0	10
	IVK WKN 6 TK-3	Z7.255.8327.0	10
	IVK WKN 6 TK-4	Z7.256.8427.0	10
	IVK WKN 6 TK-5	Z7.256.8527.0	10
	IVK WKN 6 TK-6	Z7.256.8527.0	10

## Cover strips and test plugs

### Cover strip with warning symbol

- Over 4 blocks, tension spring connection



- Over 4 blocks, screw connection

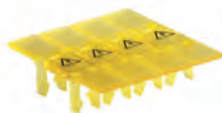

Description	Type	Part No.	Std. Pack
<b>for tension spring connection</b>			
1.5 mm <sup>2</sup> , 4 mm wide	ADF 1,5/5 GELB	04.343.6953.8	10
2.5 mm <sup>2</sup> , 5 mm wide	ADFN 2,5/4 GELB	04.343.8353.8	10
4 mm <sup>2</sup> , 6 mm wide	ADF 4/4 GELB	04.343.6153.8	10
6 mm <sup>2</sup> , 8 mm wide	ADF 6/4 GELB	04.343.6253.8	10
10 mm <sup>2</sup> , 10 mm wide	ADF 10/4 GELB	04.343.6453.8	10
16 mm <sup>2</sup> , 12 mm wide	ADF 16/4 GELB	04.343.6653.8	10
35 mm <sup>2</sup> , 16 mm wide	ADF 35/5 GELB	04.343.9253.8	10

<b>for screw connection</b>			
WKN 35/U, 16 mm wide, screw M5	AD 16/4 GELB	04.343.5256.8	10
WKN 70/U, 24 mm wide, screw M6	AD 24/4 GELB	04.343.5356.8	10
WKN 150/U, 28 mm wide, screw M8	ADN 28/4 GELB	04.343.5456.8	10

### Test plug with tension spring connection

- For WKF/WKC terminal blocks
- For 2.5 mm<sup>2</sup>, 5 mm wide and 4 mm<sup>2</sup>, 6 mm wide



Description	Type	Part No.	Std. Pack
Test plug	PSWKC/F	Z1.299.9753.0	10
Blind piece		01.299.9753.0	10
Endplate	ZP/AP PS	07.312.6053.0	10

<b>General data</b>			
Width	5 mm / 6 mm*		
Wire strip length	8 mm		
Technical data	IEC	UL	CSA
Cross section solid	0.13 – 1.5 mm <sup>2</sup>		
Cross section fine-stranded	0.13 – 1.5 mm <sup>2</sup>		
Rated current	13.5 A		
Rated voltage	400 V		
Note	* For 6 mm spacing a ZP/AP PS is snapped on behind each test plug or blind piece.		

### Test plug

- 250 V / 2 A



Description	Type	Part No.	Std. Pack
Test plug 2.3 mm red	ST 2/2 RT	Z5.553.2921.0	10
Test plug 2.3 mm black	ST 2/2 SW	Z5.553.2921.1	50
Test plug 2.3 mm blue	ST 2/2 BL	Z5.553.2921.6	100
Test plug 4 mm black	ST 2/4 SW	Z5.553.3121.0	10

## Tools

### Wire entry guides

- For conductors with cross sections smaller than 1 mm<sup>2</sup>



Description	Type	Part No.	Std. Pack
<b>1.5 mm<sup>2</sup>, 4 mm wide</b>			
for 0.13–0.2 mm <sup>2</sup> wires	LEL 1,5/1 WEISS	05.564.4253.0	10
for 0.25–0.5 mm <sup>2</sup> wires	LEL 1,5/2 GRAU	05.564.4353.0	10
<b>2.5 mm<sup>2</sup>, 5 mm wide</b>			
for 0.13–0.2 mm <sup>2</sup> wires	LELN 2,5/1 WEISS	05.564.3755.0	100
for 0.25–0.5 mm <sup>2</sup> wires	LELN 2,5/1 GRAU	05.564.3855.0	100
for 0.75–1.0 mm <sup>2</sup> wires	LELN 2,5/1 SCHWARZ	05.564.3955.0	100
<b>4 mm<sup>2</sup>, 6 mm wide</b>			
for 0.13–0.2 mm <sup>2</sup> wires	LEL 4/1 WEISS	05.561.8553.0	100
for 0.25–0.5 mm <sup>2</sup> wires	LEL 4/2 GRAU	05.561.8653.0	100
for 0.75–1.0 mm <sup>2</sup> wires	LEL 4/3 SCHWARZ	05.561.8753.0	100

### Notching tool for cross connectors

- For 1.5 mm<sup>2</sup>, 4 mm wide
- For 2.5 mm<sup>2</sup>, 5 mm wide
- For 4 mm<sup>2</sup>, 6 mm wide



Description	Type	Part No.	Std. Pack
Notching tool	AKW /A	95.300.0500.0	1

### Screwdrivers



Description	Type	Part No.	Std. Pack
<b>1.5 mm<sup>2</sup>, 4 mm wide</b>			
Uninsulated, long and straight	DIN 5264 A 0,4x2,5	06.502.4300.0	5
<b>2.5 mm<sup>2</sup>, 5 mm wide</b>			
Uninsulated, long and straight	DIN 5264 B 0,6x3,5	06.502.4000.0	10
Uninsulated, short and straight	DIN 5264 B 0,6x3,5 M	06.502.5000.0	10
Uninsulated, long and angled	DIN 5264 B 0,6x3,5 W	05.502.4100.0	10
Uninsulated, short and angled	DIN 5264 B 0,6x3,5 MW	05.502.4000.0	10
<b>4 mm<sup>2</sup>, 6 mm wide</b>			
Uninsulated, long and straight	DIN 5264 B 0,6x3,5	06.502.4000.0	10
Uninsulated, short and straight	DIN 5264 B 0,6x3,5 M	06.502.5000.0	10
Uninsulated, long and angled	DIN 5264 B 0,6x3,5 W	05.502.4100.0	10
Uninsulated, short and angled	DIN 5264 B 0,6x3,5 MW	05.502.4000.0	10
<b>6 mm<sup>2</sup>, 8 mm wide</b>	DIN 5264 B 0,6x4	06.502.4100.0	5
<b>10 mm<sup>2</sup>, 10 mm wide</b>	DIN 5264 B 0,6x4	06.502.4100.0	5
<b>16 mm<sup>2</sup>, 12 mm wide</b>	DIN 5264 B 1x5,5	06.502.4200.0	5
<b>35 mm<sup>2</sup>, 16 mm wide</b>	DIN 5264 B 1x5,5	06.502.4200.0	5

## Ferrules and tools

### Ferrules with insulating material sleeve

- **Materials:**  
Sleeve: Polypropylene, temperature resistance 105°C, creepage resistant  
Tube: E-Cu, galvanically tin-plated

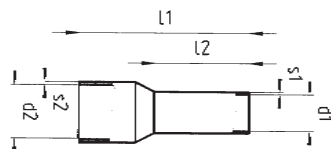

### without insulating material sleeve

- **Materials:** Tube: E-Cu, galvanically tin-plated

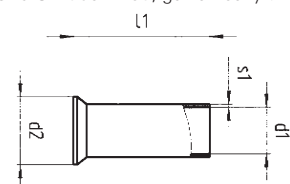

Cross section mm <sup>2</sup>	Color	Type	Part No.	Std. Pack
<b>Ferrules with insulating material sleeve according to DIN 46228T4</b>				
0.50	norm.	white	06.600.2027.0	100
0.75	norm.	gray	06.600.2127.0	100
1.00	norm.	res	06.600.2227.0	100
1.50	norm.	black	06.600.2327.0	100
1.50	long	black	06.600.2427.0	100
2.50	norm.	blue	06.600.2527.0	100
2.50	long	blue	06.600.2627.0	100
4.00	norm.	gray	06.600.2727.0	100
4.00	long	gray	06.600.2827.0	100
6.00	norm.	yellow	06.600.2927.0	100
6.00	long	yellow	06.600.3027.0	100
10.00	norm.	red	06.600.3127.0	100
10.00	long	red	06.600.3227.0	100
16.00	norm.	blue	06.600.3327.0	100
16.00	long	blue	06.600.3427.0	100
25.00	mid-length	yellow	06.600.3527.0	50
<b>Ferrules without insulating material sleeve according to DIN 46228T1</b>				
0.50	norm.		06.600.4027.0	1000
0.75	norm.		06.600.4127.0	1000
1.00	norm.		06.600.4227.0	1000
1.50	norm.		06.600.4327.0	1000
2.50	norm.		06.600.4427.0	1000
4.00	norm.		06.600.4527.0	1000
6.00	norm.		06.600.4627.0	500
10.00	norm.		06.600.4727.0	500
16.00	norm.		06.600.4827.0	100
25.00	norm.		06.600.4927.0	100
35.00	norm.		06.600.5027.0	100

### Wire strippers



Description	Type	Part No.	Std. Pack
Wire strippers	AIW/A	95.350.0100.0	1
<b>General data</b>			
Wire strip length	0.08 - 10 mm <sup>2</sup>		
Cross section, AWG	28 - 7		

### Crimping tool

- for ferrules



Description	Type	Part No.	Std. Pack
Pressing tool A	Length: 180 mm PW/A	95.101.1300.0	1
Pressing tool B	Length: 203 mm PW/B	95.101.1100.0	1
Pressing tool C	Length: 203 mm PW/C	95.101.1200.0	1
<b>General data</b>			
A: Wire strip length	0.08 - 10 mm <sup>2</sup>		
A: Cross section, AWG	28 - 7		
B: Wire strip length	10 - 25 mm <sup>2</sup>		
B: Cross section, AWG	7 - 4		
C: Wire strip length	35 - 50 mm <sup>2</sup>		
C: Cross section, AWG	2 - 1/0		

# wieplan – configuration software



**wieplan** was developed to provide you with a powerful software tool for the configuration of terminal block assemblies using Wieland DIN rail terminal blocks.

**wieplan** is available in different languages. It is userfriendly and its intuitive user interface guides you step by step to the complete terminal block assembly. After completion you can optionally order your configured terminal block assembly from Wieland completely pre-assembled.

The interface to **ePLAN P8** enables direct data exchange between the systems and reduces duplication of worksteps.

**wieplan** supports you from planning to production and helps to save time and resources and reduce costs.

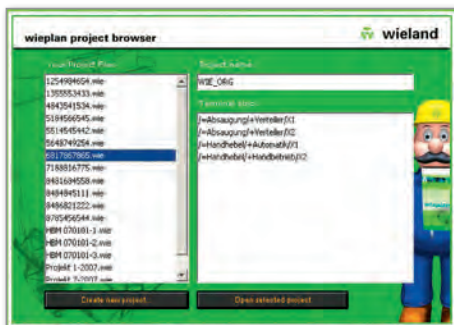

## Managing projects

### Benefits:

- **wieplan** is based on a project structure
- Bi-directional interface to **ePLAN P8** available
- Easy and clear handling of the project and terminal block assemblies
- The projects can be managed using the Wieland part numbers or even your own part numbers



## Configuring terminal block assemblies without errors

### Benefits:

- High-quality graphics enable direct display of the mounting rail
- Easy product selection due to the integrated product catalog
- The product database is automatically updated online
- Continuous plausibility checks automatically add any accessories required



## Easy product search

### Benefits:

- Clear filter functions enable a search for functionalities or ratings
- Frequently used products may be stored in a library
- **wieplan** allows you to create your own products
- Mounting rails can be planned including a mounting diagram and can be saved for future use

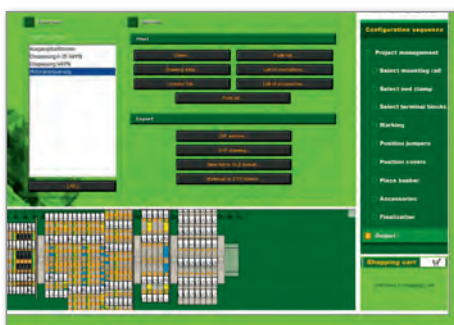

## Project data output

### Benefits:

- Project data may be used for documentation
- Print-out suitable as drawing (also \*.dxf), parts list and marking list (\*.xls), jumper list or order
- You may use your own drawing frames as well as corporate logos in existing frames
- Export of the marking details (\*.csv) for further processing in marking systems such as **wiemark**



## Solution specific, value added assembly

### Terminal block assemblies

For those who want to make their control cabinet work easier Wieland Electric pre-assembles completely equipped DIN rail terminal block assemblies, even with the cables connected, if required.

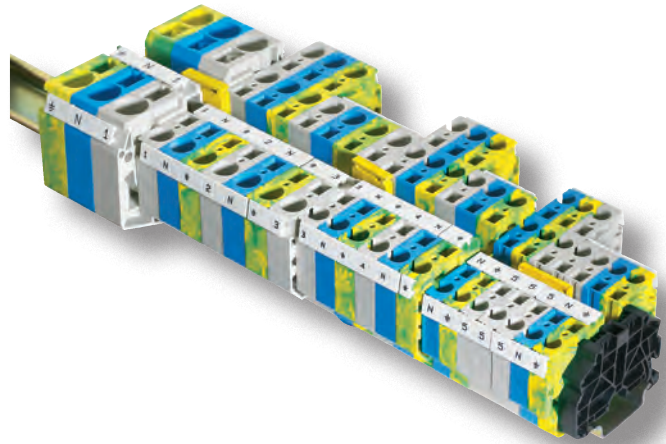

### Cable assemblies

Individual cables tailored to your needs and combined with various components can be delivered for your project in all lengths.



### Control and distribution panels

Our value-add departments will gladly assist you in selecting individual Wieland components, or in laying out complete panels, which we can also build for you.

### Interface modules – solution specific connectivity

Each control cabinet requires distribution functionality. In most cases this is accomplished with standard control panel wiring (0.5mm or 1.5mm fine stranded with ferrule) to standardized interfaces (d-sub or ribbon cables). Upon the customer's request Wieland Electric can design individual and customized solutions for all applications, too.

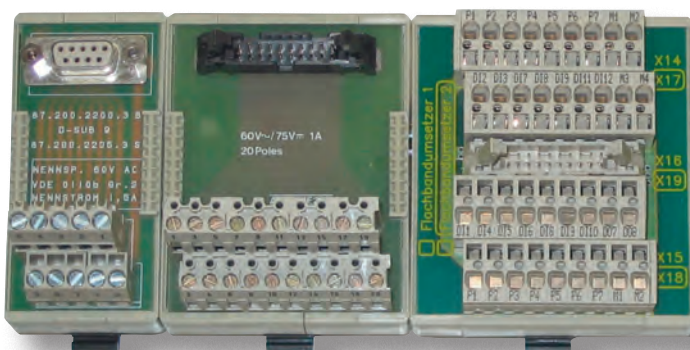
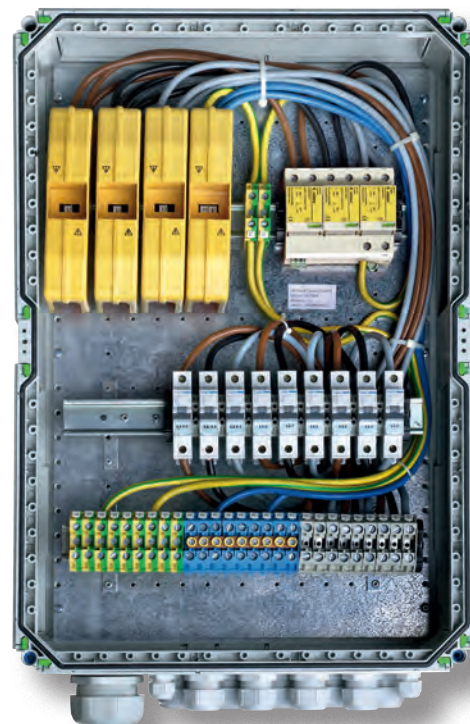

# Tables, technical data

## DIN rail terminal blocks

### Material selection *selos* and *fasis*

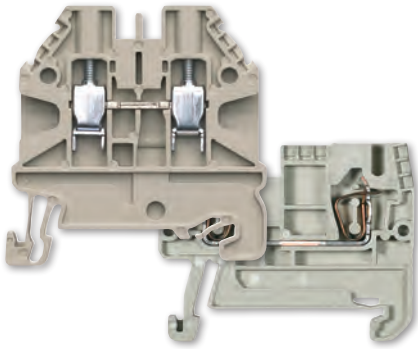

### Metal parts

- Special alloys enable low feed-through resistance and provide a gas-tight contact area:
  - Current carrying bar: Copper, or brass
  - Clamping body and clamping screws: Galvanized and chromated steel
  - Clamping spring: CrNi stainless steel
  - Current carrying bar: Copper, tinned

### Plastic materials

- Polyamide has excellent electrical, chemical and mechanical characteristics:
  - Temperature resistance: Up to 120°C
  - Creepage resistance: CTI 600
  - Flammability class: Self-extinguishing, UL94-V0

### Electrical and thermal characteristics of plastic materials

Key figures / characteristics	Standard		Unit	Thermoplast	
				Polyamide PA 666	
Dielectric strength	VDE 0303-T21	IEC 243/1	kV / mm	tr./lf.	55 / 45
Dielectric loss tan δ at 1 MHz	VDE 0303-T4	IEC 250		tr./lf.	0.02 / 0.3
Specific feed through resistance	VDE 0303-T30	IEC 93	Ω x cm	lf.	10 <sup>12</sup>
Surface resistance	VDE 0303-T30	IEC 93	Ω	lf.	10 <sup>10</sup>
Creepage	VDE 0303-T1	IEC 112	CTI		600
Operating temperature RTI *	UL 746 B		°C at 1.5 mm		120
Temperature index TI **	VDE 0304 T.21	IEC 216-1	°C		123 / 107
Minimum operating temperature without mechanical stress			°C		-40
Flammability	UL 94		Class / material thickness		V0 / 0.4
Suitability for tropical areas					good

\* electrical value

\*\* related to 50% strain resistance drop after 5,000/20,000 hours

### Standard cross sections of round copper conductors AWG/metric

Metric size ISO mm <sup>2</sup>	Comparison between AWG/kcmil and metric sizes			Metric size ISO mm <sup>2</sup>	Comparison between AWG/kcmil and metric sizes		
	AWG	kcmil	mm <sup>2</sup>		AWG	kcmil	mm <sup>2</sup>
0.1*	28		0.081	16	6		13.3
0.14*	26		0.128	25	4		21.2
0.2	24		0.205	35	2		33.6
–	22		0.324	50	(1/0) 0		53.5
0.5	20		0.519	70	(2/0) 00		67.4
0.75	18		0.82	95	(3/0) 000		85
1	–		–	–	(4/0) 0000		107.2
1.5	16		1.3	120		250	127
2.5	14		2.1	150		300	152
4	12		3.3	185		350	177
6	10		5.3	240		500	253
10	8		8.4	300		600	304

\* not standardized

## Mounting rails

### Maximum short-time current capability assigned to mounting rails

DIN EN 60 947-7-2

Rail profile	Material	Equivalent E-Cu cross section  mm <sup>2</sup>	Short-time- current capability	Rated thermal current of a PEN busbar A
			1 s kA	
DIN rail TH 15 x 5,5 according to IEC 60 715	Steel	10	1.2	–
G rail TS 32 according to IEC 60 715	Steel	35	4.2	–
	Copper <sup>1)</sup>	120	14.4	269
	Aluminium <sup>1)</sup>	70	8.4	192
DIN rail TS 35 x 27 x 7,5 according to IEC 60 715	Steel	16	1.92	–
DIN rail TS 35 x 27 x 15 according to IEC 60 715	Steel	25	3	–
DIN rail TS 35 x 24 x 15 according to IEC 60 715 (made from 2.3 mm thick material)	Steel	50	6	–
	Copper <sup>1)</sup>	150	18	309

<sup>1)</sup> Selected copper or aluminum alloys from the manufacturer of the terminal block layout were used to achieve the values in the table.

## Torques

Torque according to EN 60947-1 for <b>selos</b> DIN rail terminal blocks					
			II	III	
II applies for screws that are tightened with a screwdriver  III applies for screws that can be tightened with tools other than a screwdriver	<b>WT 2.5, width 5 mm</b>	M2.5 clamping body screw	Nm	0.4	
	<b>WT 4 ... , width 6 mm</b>	M3 clamping body screw	Nm	0.5	
	<b>WT 6 and WKN 6, width 8 mm</b>	M4 clamping body screw	Nm	1.2	
		M3.5 screw for cross connector	Nm	0.8	
	<b>WT 10, width 10 mm</b>	M4 clamping body screw	Nm	1.2	
	<b>WT 16, width 12 mm</b>	M5 clamping body screw	Nm	2.0	
	<b>WKN 35, width 16 mm</b>	M6 clamping body screw	Nm	2.5	3.0
		M5 screw for cross connector	Nm	2.0	2.0
	<b>WKN 70, width 24 mm</b>	M8 clamping body screw	Nm	3.5	6.0
		M6 screw for cross connector	Nm	2.5	3.0
	<b>WKN 150, width 28 mm</b>	M10 clamping body screw	Nm	4.0	10.0
		M8 screw for cross connector	Nm	3.5	6.0

# Information about Ex applications

## DIN rail terminal blocks for installations with explosion hazard (Ex terminals) Protection category Increased safety "e"

Ex terminals are DIN rail terminal blocks that have been tested and certified by a European Ex test institute according to

**EN 60 079-0 – VDE 0170/0171 part 1 "General requirements" and**

**EN 60 079-7 – VDE 0170/0171 part 6 Protection category: Increased safety "e"**

DIN EN 60079-0, VDE 0170-1: Explosionsfähige Atmosphäre - Teil 0: Geräte - Allgemeine Anforderungen (IEC 60079-0:2007); Deutsche Fassung EN 60079-0:2009

DIN EN 60079-7, VDE 0170-6: Explosionsfähige Atmosphäre - Teil 7: Geräteschutz durch erhöhte Sicherheit „e“ (IEC 60079-7:2006); Deutsche Fassung EN 60079-7:2007

The protection category Increased safety "e" applies to electrical equipment that resists sparks, electric arcing or hazardous surface temperatures during operation. DIN rail terminal blocks thus fall into temperature category T6 in which electrical equipment at an ambient temperature of 40 °C and proper use does not exceed the maximum temperature (surface temperature) of 85 °C.

Certifying test institutes are, for example, the Physikalisch Technische Bundesanstalt PTB in Germany, the Laboratoire Central des Industries Electrique LCIE in France, the Health and Safety Executive BSEFA in Great Britain, the EX laboratory of ASEV in Switzerland, among others.

However, for DIN rail terminal blocks as incomplete electrical equipment, only a partial certification is issued. This certificate is the basis for the final acceptance and certification of the complete installation before it is commissioned by an expert.

The certificate (prototype test certificate) includes a description of the DIN rail terminal blocks, in which special requirements regarding the preparation of terminal strips are put into place, for example, installing partitions and end plates when terminal blocks are connected in series. This information is also provided in our catalog that in this case serves as an instruction manual.

### Test Certificate

Certificates from notified bodies are available for feed-through terminal blocks of series WK(N).., WKF.., WKFN.., WT and ground blocks of series WK..SL.., WKF..SL.., WKFN..SL.. as well as **revos** Ex industrial multipole connectors.

The certificates indicate the relevant rated values and include the accessories listed in the description.

The areas of application are divided into:

**Group I: Electrical equipment for mine openings with firedamp hazard**

**Group II: Electrical equipment for hazardous areas except for mine openings with firedamp hazard (for example installations with explosion hazard for the chemical and petrochemical industry).**

According to a resolution of the DEK (Deutsche Elektrotechnische Kommission) terminal blocks are also accepted as electrical equipment for Group I (firedamp protection Ex e I) for which only the increased safety protection type 'e' for Group II (explosion protection Ex e II) has been certified and vice versa.

Ex protected DIN rail terminal blocks are identified with distinct safety protection and an additional marking according to ATEX directive 94/9/EG. The complete test certificate with a description is available on request or it can be downloaded from Wieland Electric Download Center.

### Protection category "Intrinsic safety Ex i"



The DIN rail terminal blocks can be used in Group II (Category 2) and Group 1 (Category M2) equipment, as the standard requirements are identical in this case.

It has been generally accepted that feed-through terminals in intrinsic circuits are clearly marked with the blue coloring of the insulated housing. For intrinsic circuits, feed-through terminals can be used in the standard version and if required are available with blue insulating housing.

**Technical information**

- The information regarding cross sectional area and connection types pertains to unprepared wires without ferrules! Ferrules are not necessary for secure connection. Whenever ferrules are used, make sure that the tools specified by the manufacturer are used exclusively.
- The voltage ratings apply to the terminals in their intended application. When different products are mounted adjacent to each other, the proper isolation distances must be adhered to.
- If the ground blocks are not used in block assemblies, but are mounted to the rail as single terminal blocks, end clamps have to be used.
- A detailed description of technical data, the standards requirements, and the application conditions are available in the flyer **facts & DATA**.

**ATEX regulation**

- For the use of DIN rail terminal blocks in Ex areas, the regulations of EN 60079-0 apply; whereas for increased safety Exe the regulations of EN 60079-7 must be followed. For an approximation of the laws of the EU member states, directive 94/9/EG was created, which is generally known as ATEX 100a and which is the basis for harmonization in this field. ATEX stands for "atmosphere explosive" while 100a refers to the corresponding article of the EC contract.
- Directive ATEX 100a applies for protection against dust and gas explosions in all industrial Ex areas and in mining. The testing and certificating institutes named in directive ATEX 100a must follow accreditation procedures which are the same throughout Europe.
- In accordance with EN 60070-0/60079-7 and ATEX 100a, these certifying institutes write out EC certificates for prototype tests. These prototype test certificates for components together with the corresponding quality system certification of the supplier are required to obtain the so-called ATEX approval.
- In combination with the  mark, the markings of the Wieland terminal blocks have the following meaning:
  -  Identification
  - II Device group
  - 2 Category
  - G D Areas
  - KEMA Name of testing institute
  - ATEX... Certificate, year of testing, number

**Mounting instructions for Ex e applications**

- If feed-through blocks are mounted directly adjacent to other feed-through blocks of a different size, or directly adjacent to ground blocks, the open side of the block group of the same type must be covered by an end plate or partition.
- If adjacent DIN rail terminal blocks are jumpered or if jumpered DIN rail terminal blocks are positioned next to unjumpered DIN rail terminal blocks, a partition plate must be inserted between the individual terminal block groups or at the beginning and end of a laterally or longitudinally connected terminal block (group) in order to meet the specified isolation distances. Notched out and jumpering cross connectors can not be used in Ex areas.
- If the terminal blocks are combined with other certified series and sizes and when their accessories are used, the required creepage distances and clearances must be adhered to.
- The feed through terminal blocks and protective conductor terminal blocks are suitable for enclosures for use in explosive gas atmospheres or for use in the presence of combustible dust. For explosive gas atmospheres these enclosures must satisfy the requirements of EN 60079-0 and EN 60079-7. For combustible dust these enclosures must satisfy the requirements of EN 61241-0 and EN 61241-1 rather EN 50281-1-1.
- If the DIN rail terminal blocks are installed in a housing with protection type "e" (increased safety) according to EN 60079-7, the clearances and creepage distances stated in Table 1 must be adhered to..
- The indicated values for the current carrying capability refer to a maximum ambient temperature of 40 °C. When the terminal blocks are loaded with the maximum rated current the temperature rise will be max. 45 K.
- Operating temperature range:
  - 40°C ... +80°C, series WK(N)/M..., WKF..., WT
  - 20°C ... +80°C, series WKFN
- If cables are used whose cross-section is smaller than the nominal cable cross-section, the corresponding lower current must be specified in the EC prototype test certificate for the complete device.
- Due to the heat generated during operation at the specified current and at ambient temperatures of ≤ 40 °C, the DIN rail terminal blocks can be installed in equipment (mainly distribution and connection boxes) suitable for temperature class T6. If DIN rail terminal blocks are installed in equipment with a temperature class ranging from T1 to T5, it must be ensured that the maximum temperature of the insulating parts does not exceed the maximum value in the operating temperature range.

**Temperature classes**

Temperature class	T1	T2	T3	T4	T5	T6
Maximum surface temperature at equipment in °C	450	300	200	135	120	85

## SCCR Values for DIN rail terminal blocks

As a result of changes to the 2005 NEC, both the operator and manufacturer of electrical equipment must comply with increased requirements related to resistance to short-circuiting of equipment. In accordance with both the NEC 2005 Article 409.110 and UL 508A, the short circuit resistance of the complete installation must now be considered. The installation's Short Circuit Current Rating must be indicated on the equipment or control panel's legend plate.

Wieland has tested and determined individual SCCR values for their terminal blocks in connection with the widest variety of fuses. These ratings are far greater than the default values contained in UL 508A. As a result, when qualifying your installation, you have increased flexibility and accuracy when using Wieland terminal blocks.



### What does SCCR marking mean?

The Short Circuit Current Rating (SCCR) of a component represents the maximum short circuit current level a device can safely withstand without compromising safety for installations and personnel. Article 409 on industrial control panels was added to the NEC in the 2005 edition. This article calls for all industrial control panels to be marked with a Short Circuit Current Rating. The Short Circuit Current Rating (SCCR) requirements for UL 508A came into force in April 2006.

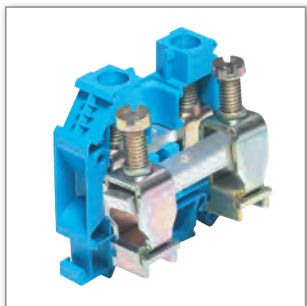

### How is the SCCR marking determined?

The NEC Article 409 refers to the UL 508A Supplement SB as an approved method for determining the SCCR of an industrial control panel. This specific method is outlined in Section SB4.

1. Determination of the SCCR values of individual components, for example DIN rail terminal blocks
2. Modification of the SCCR values through the use of current limiting devices per UL 508 SB 4.3
3. Selection of the lowest SCCR value from all the components



### SCCR for DIN rail terminal blocks in general

The SCCR of a terminal block can be determined according to UL 508A using one of the following methods:

1. Use the tested SCCR value
2. Use the default SCCR value as specified in table 4.1 of UL 508

If the DIN rail terminal blocks do not have a tested SCCR, then the UL default value of 10kA must be used. This relatively low value would limit the SCCR of the entire system to max. 10kA.

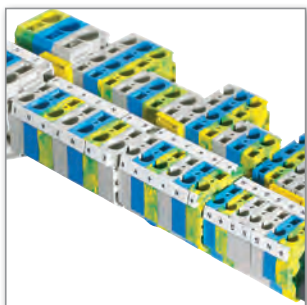

### SCCR for Wieland DIN rail terminal blocks

Wieland determined SCCR values for its DIN rail terminal blocks used in conjunction with fuses and circuit breakers. The resulting SCCR values are much higher than the values specified for DIN rail terminal blocks in table SB 4.1 of UL 508A. You will find the tested SCCR values for our **selos** and **fasis** product series in our customer information 0019.3, available on [www.wieland-electric.com](http://www.wieland-electric.com). The SCCR values are also published on the UL website (<http://www.ul.com>) under file number E60678.

01.299.9753.0	141	04.343.6653.8	71	04.841.5950.0	138	04.855.0353.0	136
04.019.0289.0	132	04.343.6653.8	74	04.841.6050.0	138	04.855.0353.6	27
04.019.0289.0	132	04.343.6653.8	74	04.841.6150.0	138	04.855.0453.0	136
04.019.0289.0	133	04.343.6653.8	81	04.841.6250.0	138	04.855.0553.0	136
04.019.0289.0	139	04.343.6653.8	97	04.841.6350.0	138	04.855.0653.0	136
04.019.1189.0	132	04.343.6653.8	141	04.841.6450.0	138	04.855.0753.0	136
04.241.1150.0	138	04.343.6853.8	103	04.841.6550.0	138	04.855.0853.0	136
04.242.0850.0	136	04.343.6953.8	67	04.841.6650.0	138	04.855.0953.0	136
04.242.0950.0	139	04.343.6953.8	76	04.841.6750.0	138	04.855.1053.0	136
04.242.1250.0	139	04.343.6953.8	83	04.841.6850.0	138	04.855.1153.0	139
04.242.1553.0	136	04.343.6953.8	141	04.841.6950.0	138	04.855.1253.0	139
04.242.2853.0	139	04.343.8353.8	69	04.841.7050.0	138	04.855.3153.0	136
04.242.5053.0	136	04.343.8353.8	77	04.841.7150.0	138	04.855.3253.0	136
04.242.5153.0	136	04.343.8353.8	85	04.841.7250.0	138	04.856.0053.0	137
04.242.6053.0	137	04.343.8353.8	87	04.841.7350.0	138	04.856.0153.0	137
04.242.6353.0	137	04.343.8353.8	89	04.841.7450.0	138	04.856.0253.0	137
04.242.8053.0	137	04.343.8353.8	93	04.841.7550.0	138	04.856.0353.0	137
04.243.0755.0	85	04.343.8353.8	101	04.841.7650.0	138	04.856.0453.0	137
04.243.0855.0	87	04.343.8353.8	102	04.841.7750.0	138	04.856.0553.0	137
04.243.0855.0	89	04.343.8353.8	103	04.841.9050.0	138	04.856.0653.0	137
04.243.0855.0	122	04.343.8353.8	141	04.841.9150.0	138	04.856.0753.0	137
04.243.0855.0	122	04.343.9056.8	35	04.841.9250.0	138	04.856.0853.0	137
04.243.0953.0	83	04.343.9156.8	35	04.842.0850.0	136	04.856.0953.0	137
04.243.2053.0	136	04.343.9253.8	81	04.842.1553.0	136	04.856.1053.0	137
04.243.8550.0	132	04.343.9253.8	141	04.842.4953.0	136	04.856.1153.0	139
04.244.0053.0	110	04.344.1455.8	13	04.842.5053.0	136	04.856.1253.0	139
04.244.0053.0	111	04.344.1655.8	13	04.842.5553.0	137	04.856.3153.0	137
04.244.0053.0	113	04.344.1855.8	13	04.842.5953.0	137	04.856.3253.0	137
04.244.0053.8	113	04.344.1855.8	13	04.842.6053.0	137	04.858.0053.0	137
04.304.0181.0	51	04.344.2255.8	13	04.842.6553.0	137	04.858.0153.0	137
04.304.0181.0	51	04.841.1150.0	138	04.842.7953.0	137	04.858.0253.0	137
04.304.0281.0	51	04.841.1250.0	138	04.842.8053.0	137	04.858.0353.0	137
04.304.0281.0	51	04.841.1350.0	138	04.842.8553.0	137	04.858.0453.0	137
04.312.2056.0	32	04.841.1450.0	138	04.842.8553.0	137	04.858.0553.0	137
04.325.1056.0	57	04.841.1550.0	138	04.843.2053.0	136	04.858.0653.0	137
04.325.1156.0	58	04.841.1650.0	138	04.844.2053.0	110	04.858.0753.0	137
04.325.1256.0	58	04.841.1750.0	138	04.844.2053.0	111	04.858.0853.0	137
04.325.1356.0	59	04.841.1850.0	138	04.844.2053.0	113	04.858.0953.0	137
04.325.1456.0	59	04.841.1950.0	138	04.844.2153.0	110	04.858.1053.0	137
04.325.1656.0	57	04.841.2050.0	138	04.844.2153.0	111	04.858.1153.0	139
04.326.2053.8	22	04.841.2150.0	138	04.844.2153.0	113	04.858.1253.0	139
04.326.2053.8	27	04.841.2250.0	138	04.844.2253.0	110	04.858.3153.0	137
04.326.2053.8	35	04.841.2350.0	138	04.844.2253.0	111	04.858.3253.0	137
04.326.2153.8	37	04.841.2450.0	138	04.844.2253.0	113	04.900.0000.0	139
04.326.2253.8	44	04.841.2550.0	138	04.845.0153.0	136	04.900.1053.0	139
04.326.2353.8	44	04.841.2650.0	138	04.845.0253.0	136	04.900.2053.0	139
04.326.2553.8	14	04.841.2750.0	138	04.845.0353.0	136	04.900.3053.0	139
04.326.2653.8	14	04.841.2850.0	138	04.845.0453.0	136	04.900.4053.0	139
04.326.2953.8	54	04.841.2950.0	138	04.845.0553.0	136	05.502.4000.0	142
04.326.3053.8	54	04.841.3050.0	138	04.845.0653.0	136	05.502.4000.0	142
04.326.3053.8	55	04.841.3150.0	138	04.845.0753.0	136	05.502.4100.0	142
04.326.3053.8	55	04.841.3250.0	138	04.845.0853.0	136	05.502.4100.0	142
04.342.0556.0	27	04.841.3350.0	138	04.845.0953.0	136	05.508.3121.0	58
04.342.3556.8	34	04.841.3450.0	138	04.845.1053.0	136	05.508.3221.0	58
04.343.4756.8	22	04.841.3550.0	138	04.846.0153.0	137	05.508.6521.0	59
04.343.4956.8	44	04.841.3650.0	138	04.846.0253.0	137	05.508.6521.0	59
04.343.5056.8	44	04.841.3750.0	138	04.846.0353.0	137	05.508.8821.0	57
04.343.5256.8	14	04.841.3850.0	138	04.846.0453.0	137	05.508.8921.0	57
04.343.5256.8	141	04.841.3950.0	138	04.846.0553.0	137	05.511.2953.0	43
04.343.5356.8	14	04.841.4050.0	138	04.846.0653.0	137	05.511.2953.6	43
04.343.5356.8	141	04.841.4150.0	138	04.846.0753.0	137	05.511.2953.7	43
04.343.5456.8	14	04.841.4250.0	138	04.846.0853.0	137	05.511.2953.8	43
04.343.5456.8	141	04.841.4350.0	138	04.846.0953.0	137	05.511.2953.9	43
04.343.6053.8	102	04.841.4450.0	138	04.846.1053.0	137	05.561.0053.0	34
04.343.6053.8	102	04.841.4550.0	138	04.848.0153.0	137	05.561.0053.0	34
04.343.6153.8	71	04.841.4650.0	138	04.848.0253.0	137	05.561.0053.0	103
04.343.6153.8	78	04.841.4750.0	138	04.848.0353.0	137	05.561.4115.0	35
04.343.6153.8	94	04.841.4850.0	138	04.848.0453.0	137	05.561.6553.0	102
04.343.6153.8	95	04.841.4950.0	138	04.848.0553.0	137	05.561.6553.0	102
04.343.6153.8	97	04.841.5050.0	138	04.848.0653.0	137	05.561.6553.0	110
04.343.6153.8	141	04.841.5150.0	138	04.848.0753.0	137	05.561.6553.0	111
04.343.6253.8	72	04.841.5250.0	138	04.848.0853.0	137	05.561.6553.0	113
04.343.6253.8	79	04.841.5350.0	138	04.848.0953.0	137	05.561.6653.0	102
04.343.6253.8	141	04.841.5450.0	138	04.848.1053.0	137	05.561.6653.0	102
04.343.6453.8	73	04.841.5550.0	138	04.855.0053.0	136	05.561.6653.0	110
04.343.6453.8	81	04.841.5650.0	138	04.855.0153.0	136	05.561.6653.0	111
04.343.6453.8	141	04.841.5750.0	138	04.855.0253.0	136	05.561.6653.0	113
04.343.6653.8	69	04.841.5850.0	138	04.855.0253.5	27	05.561.6753.0	102

# Index

05.561.6753.0	102	05.564.3955.0	142	06.502.5000.0	142	07.311.0653.0	55
05.561.6753.0	110	05.564.4253.0	67	06.600.2027.0	143	07.311.0653.0	55
05.561.6753.0	111	05.564.4253.0	76	06.600.2127.0	143	07.311.0753.0	54
05.561.6753.0	113	05.564.4253.0	83	06.600.2227.0	143	07.311.0853.0	54
05.561.8553.0	71	05.564.4253.0	142	06.600.2327.0	143	07.311.0853.0	54
05.561.8553.0	78	05.564.4353.0	67	06.600.2427.0	143	07.311.0853.6	54
05.561.8553.0	91	05.564.4353.0	76	06.600.2527.0	143	07.311.0853.6	54
05.561.8553.0	94	05.564.4353.0	83	06.600.2627.0	143	07.311.1853.0	54
05.561.8553.0	95	05.564.4353.0	142	06.600.2727.0	143	07.311.1853.0	54
05.561.8553.0	97	05.566.6855.9	41	06.600.2827.0	143	07.311.2053.8	22
05.561.8553.0	142	05.567.9155.0	101	06.600.2927.0	143	07.311.2053.8	27
05.561.8653.0	71	05.576.5853.0	34	06.600.3027.0	143	07.311.2053.8	35
05.561.8653.0	78	05.584.0053.0	34	06.600.3127.0	143	07.311.2153.8	37
05.561.8653.0	91	05.592.7553.0	37	06.600.3227.0	143	07.311.2853.8	54
05.561.8653.0	94	05.592.7653.0	37	06.600.3327.0	143	07.311.2853.8	55
05.561.8653.0	95	05.593.5953.0	58	06.600.3427.0	143	07.311.2853.8	55
05.561.8653.0	97	05.902.3500.0	110	06.600.3527.0	143	07.311.2953.8	54
05.561.8653.0	142	05.902.3500.0	111	06.600.4027.0	143	07.311.3855.0	37
05.561.8753.0	71	05.902.3500.0	113	06.600.4127.0	143	07.311.4155.0	32
05.561.8753.0	78	06.502.4000.0	69	06.600.4227.0	143	07.311.4255.0	36
05.561.8753.0	91	06.502.4000.0	71	06.600.4327.0	143	07.311.4355.0	36
05.561.8753.0	94	06.502.4000.0	77	06.600.4427.0	143	07.311.4655.0	37
05.561.8753.0	95	06.502.4000.0	78	06.600.4527.0	143	07.311.6155.0	29
05.561.8753.0	97	06.502.4000.0	87	06.600.4627.0	143	07.311.6155.0	31
05.561.8753.0	142	06.502.4000.0	93	06.600.4727.0	143	07.311.7855.0	14
05.561.9153.0	35	06.502.4000.0	94	06.600.4827.0	143	07.311.7955.0	14
05.562.2453.0	102	06.502.4000.0	95	06.600.4927.0	143	07.311.8155.0	29
05.562.2453.0	103	06.502.4000.0	97	06.600.5027.0	143	07.311.8155.0	31
05.562.2453.0	106	06.502.4000.0	101	07.201.1227.6	48	07.311.9055.0	34
05.562.2453.0	106	06.502.4000.0	101	07.201.1327.6	48	07.311.9155.0	34
05.562.2453.0	106	06.502.4000.0	103	07.201.3227.6	48	07.311.9855.0	34
05.562.2453.0	107	06.502.4000.0	106	07.201.3327.6	48	07.312.0053.0	60
05.562.2553.0	102	06.502.4000.0	106	07.201.4227.0	52	07.312.0153.0	60
05.562.2553.0	103	06.502.4000.0	106	07.201.4227.0	53	07.312.0253.0	60
05.562.2553.0	106	06.502.4000.0	107	07.201.4327.0	52	07.312.0353.0	61
05.562.2553.0	106	06.502.4000.0	109	07.201.4327.0	53	07.312.0453.0	41
05.562.2553.0	106	06.502.4000.0	110	07.201.4427.0	52	07.312.0453.0	43
05.562.2553.0	107	06.502.4000.0	111	07.201.4427.0	53	07.312.0453.0	44
05.562.2653.0	102	06.502.4000.0	113	07.201.5227.6	48	07.312.0453.0	44
05.562.2653.0	103	06.502.4000.0	119	07.201.5327.6	48	07.312.0453.0	45
05.562.2653.0	106	06.502.4000.0	121	07.201.7227.6	49	07.312.0453.0	45
05.562.2653.0	106	06.502.4000.0	123	07.201.7327.6	49	07.312.0555.0	26
05.562.2653.0	106	06.502.4000.0	142	07.201.8227.0	53	07.312.0555.0	26
05.562.2653.0	107	06.502.4000.0	142	07.201.8327.0	53	07.312.1255.0	25
05.563.5453.0	43	06.502.4100.0	72	07.201.8427.0	53	07.312.1255.0	25
05.564.0753.0	51	06.502.4100.0	79	07.201.9227.6	49	07.312.1555.0	34
05.564.3755.0	69	06.502.4100.0	119	07.201.9327.6	49	07.312.1655.0	34
05.564.3755.0	77	06.502.4100.0	121	07.205.1227.0	52	07.312.1755.0	22
05.564.3755.0	85	06.502.4100.0	142	07.205.1327.0	52	07.312.1855.0	22
05.564.3755.0	87	06.502.4100.0	142	07.205.1427.0	52	07.312.2953.0	111
05.564.3755.0	89	06.502.4200.0	69	07.205.5227.0	51	07.312.2953.0	113
05.564.3755.0	93	06.502.4200.0	71	07.205.5327.0	51	07.312.2953.6	111
05.564.3755.0	101	06.502.4200.0	73	07.205.7227.0	51	07.312.2953.6	113
05.564.3755.0	119	06.502.4200.0	75	07.205.7327.0	51	07.312.2953.9	111
05.564.3755.0	121	06.502.4200.0	81	07.205.8227.0	51	07.312.2953.9	113
05.564.3755.0	123	06.502.4200.0	97	07.205.8327.0	51	07.312.3153.0	110
05.564.3755.0	142	06.502.4200.0	142	07.205.9227.0	51	07.312.3153.6	110
05.564.3855.0	69	06.502.4200.0	142	07.205.9327.0	51	07.312.3153.9	110
05.564.3855.0	77	06.502.4300.0	67	07.257.0227.0	27	07.312.3553.0	103
05.564.3855.0	85	06.502.4300.0	76	07.257.0327.0	27	07.312.3653.0	103
05.564.3855.0	87	06.502.4300.0	83	07.257.2027.0	27	07.312.4153.0	102
05.564.3855.0	89	06.502.4300.0	142	07.300.6955.0	45	07.312.4153.0	102
05.564.3855.0	93	06.502.5000.0	69	07.300.7055.0	45	07.312.4153.6	102
05.564.3855.0	101	06.502.5000.0	71	07.310.3153.0	57	07.312.4753.0	102
05.564.3855.0	119	06.502.5000.0	77	07.310.3153.0	57	07.312.5953.0	109
05.564.3855.0	121	06.502.5000.0	78	07.310.3253.0	58	07.312.6053.0	13
05.564.3855.0	123	06.502.5000.0	87	07.310.3353.0	59	07.312.6053.0	141
05.564.3855.0	142	06.502.5000.0	93	07.310.3353.0	59	07.312.6755.0	68
05.564.3955.0	69	06.502.5000.0	94	07.310.3453.0	57	07.312.6755.0	77
05.564.3955.0	77	06.502.5000.0	95	07.310.3453.0	57	07.312.6755.0	118
05.564.3955.0	85	06.502.5000.0	97	07.310.3553.0	58	07.312.6755.0	120
05.564.3955.0	87	06.502.5000.0	101	07.310.3653.0	59	07.312.6755.6	68
05.564.3955.0	89	06.502.5000.0	101	07.310.3653.0	59	07.312.6855.0	68
05.564.3955.0	93	06.502.5000.0	109	07.310.3953.0	58	07.312.6855.0	118
05.564.3955.0	101	06.502.5000.0	119	07.310.4053.0	58	07.312.6855.0	120
05.564.3955.0	119	06.502.5000.0	121	07.310.5855.0	36	07.312.6955.0	68
05.564.3955.0	121	06.502.5000.0	123	07.310.9355.0	27	07.312.6955.0	77
05.564.3955.0	123	06.502.5000.0	142	07.310.9455.0	27	07.312.6955.0	92



07.312.6955.0	100	07.312.9755.0	91	07.431.7253.8	48	54.004.7553.6	57
07.312.6955.0	118	07.313.0055.0	92	07.431.7353.8	49	54.010.7553.0	58
07.312.6955.0	120	07.313.0055.0	100	07.431.7353.8	49	54.010.7553.6	58
07.312.6955.6	68	07.313.0155.0	92	25.320.0253.0	35	54.016.7553.0	58
07.312.6955.6	100	07.313.0155.0	100	25.320.1653.0	35	54.016.7553.6	58
07.312.7055.0	68	07.313.0455.0	72	25.320.3253.0	35	54.025.7553.0	59
07.312.7055.0	92	07.313.0455.0	79	25.320.4653.0	35	54.025.7553.6	59
07.312.7055.0	100	07.313.0455.6	72	25.325.0253.0	35	54.035.7553.0	59
07.312.7055.0	118	07.313.0555.0	72	25.325.1653.0	35	54.035.7553.6	59
07.312.7055.0	120	07.313.0655.0	72	25.325.3253.0	35	55.503.1053.0	54
07.312.7155.0	68	07.313.0655.0	79	25.325.4653.0	35	55.503.1053.6	54
07.312.7155.0	77	07.313.0655.6	72	25.360.0253.0	35	55.503.1253.0	55
07.312.7155.0	92	07.313.0755.0	72	25.360.1253.0	35	55.503.1353.0	55
07.312.7155.0	118	07.313.0855.0	73	25.360.3253.0	35	55.504.1053.0	54
07.312.7155.0	120	07.313.0855.0	80	25.360.4253.0	35	55.504.1053.6	54
07.312.7155.6	68	07.313.0855.6	73	25.920.0253.0	103	55.504.9153.0	54
07.312.7255.0	68	07.313.0955.0	73	25.920.0353.0	103	55.703.0053.0	109
07.312.7255.0	92	07.313.1055.0	73	25.920.0453.0	103	55.703.0053.6	109
07.312.7255.0	118	07.313.1055.0	80	25.920.0553.0	103	55.703.0553.0	112
07.312.7255.0	120	07.313.1055.6	73	25.920.0653.0	103	55.703.0553.6	112
07.312.7355.0	85	07.313.1155.0	73	25.920.0753.0	103	55.703.0553.7	112
07.312.7355.0	100	07.313.1255.0	74	25.920.0853.0	103	55.703.0553.9	112
07.312.7355.0	122	07.313.1255.0	80	25.920.0953.0	103	55.703.1053.0	112
07.312.7355.0	122	07.313.1255.6	74	25.920.1053.0	103	55.703.1053.6	112
07.312.7355.0	122	07.313.1355.0	74	25.920.1153.0	103	55.703.1053.7	112
07.312.7455.0	85	07.313.1455.0	81	25.920.1253.0	103	55.703.1053.9	112
07.312.7455.0	100	07.313.1455.0	74	25.920.1353.0	103	55.703.9053.0	109
07.312.7455.0	122	07.313.1455.6	74	25.920.1453.0	103	56.004.9053.0	60
07.312.7455.0	122	07.313.1555.0	74	25.920.1553.0	103	56.010.9053.0	60
07.312.7555.0	89	07.313.1655.0	94	25.920.1653.0	103	56.016.9053.0	60
07.312.7655.0	89	07.313.1655.0	96	25.920.3253.0	103	56.035.9053.0	61
07.312.7755.0	87	07.313.1655.0	96	25.920.3353.0	103	56.106.0055.0	41
07.312.7755.0	93	07.313.1755.0	41	25.920.3453.0	103	56.106.0155.0	41
07.312.7755.0	93	07.313.2255.0	45	25.920.3553.0	103	56.106.0553.0	43
07.312.7855.0	87	07.313.2355.0	44	25.920.3653.0	103	56.106.0653.0	43
07.312.7855.0	93	07.313.2455.0	44	25.920.3753.0	103	56.106.0755.0	41
07.312.7855.0	93	07.313.2555.0	12	25.920.3853.0	103	56.106.0855.0	41
07.312.8153.0	66	07.313.2555.0	12	25.920.3953.0	103	56.135.1055.0	48
07.312.8153.0	76	07.313.2555.0	12	25.920.4053.0	103	56.170.1055.0	48
07.312.8253.0	66	07.313.2555.0	13	25.920.4153.0	103	56.197.1055.0	48
07.312.8253.0	76	07.313.2555.0	16	25.920.4253.0	103	56.198.1055.0	49
07.312.8353.0	66	07.313.2555.0	16	25.920.4353.0	103	56.199.1055.0	49
07.312.8353.0	76	07.313.2555.0	16	25.920.4453.0	103	56.203.0055.0	118
07.312.8453.0	66	07.313.2555.0	17	25.920.4553.0	103	56.203.0055.6	118
07.312.8453.0	76	07.313.2655.0	13	25.920.4653.0	103	56.203.0055.6	118
07.312.8553.0	66	07.313.2755.0	13	30.494.4021.1	129	56.203.5055.6	118
07.312.8553.0	76	07.313.2755.0	17	30.494.4121.0	129	56.203.5155.0	118
07.312.8653.0	66	07.313.2855.0	13	32.530.0053.0	51	56.203.5155.6	118
07.312.8653.0	76	07.313.2855.0	20	32.540.0053.0	51	56.203.6955.1	122
07.312.8753.0	83	07.313.2855.0	20	32.550.0053.0	51	56.203.7055.0	122
07.312.8853.0	83	07.313.2855.0	21	32.560.0053.0	51	56.203.8955.0	122
07.312.8953.0	66	07.313.2855.0	21	37.702.7453.0	106	56.203.9055.0	120
07.312.8953.0	66	07.313.2855.0	21	37.702.7553.0	106	56.203.9155.0	120
07.312.8953.0	76	07.313.2855.0	23	37.702.7653.0	107	56.203.9355.0	120
07.312.8953.0	76	07.313.2855.0	23	37.702.8453.0	106	56.206.0055.0	119
07.312.9055.0	70	07.313.2955.0	20	37.702.8553.0	106	56.206.0055.6	119
07.312.9055.0	78	07.313.2955.0	21	37.702.8653.0	107	56.206.9055.0	121
07.312.9055.0	94	07.313.2955.0	21	37.703.0553.0	110	56.395.0055.0	52
07.312.9055.0	94	07.313.2955.0	21	37.703.0553.6	110	56.395.0155.0	52
07.312.9055.0	95	07.313.3155.0	20	37.703.0553.9	110	56.395.0255.0	52
07.312.9055.0	96	07.313.3355.0	23	37.703.1053.0	110	56.395.1055.0	52
07.312.9055.0	96	07.313.3355.0	23	37.703.1053.6	110	56.395.1255.0	52
07.312.9055.6	70	07.313.3355.0	23	37.703.1053.9	110	56.397.0055.0	52
07.312.9155.0	70	07.313.3355.0	24	38.703.0553.0	111	56.397.0155.0	52
07.312.9155.0	94	07.313.4155.0	119	38.703.0553.6	111	56.397.0255.0	52
07.312.9155.0	94	07.313.4155.0	121	38.703.0553.9	111	56.397.1255.0	52
07.312.9155.0	95	07.313.4255.0	119	38.703.1053.0	111	56.398.0055.0	53
07.312.9155.0	96	07.313.4255.0	121	38.703.1053.6	111	56.398.1055.0	53
07.312.9155.0	96	07.340.0353.0	52	38.703.1053.9	111	56.399.0055.0	53
07.312.9255.0	70	07.340.1053.0	52	39.703.0153.0	110	56.399.0155.0	53
07.312.9255.0	78	07.340.1053.0	53	39.703.0153.6	110	56.399.0255.0	53
07.312.9255.6	70	07.340.1053.0	53	39.703.0153.9	110	56.399.1055.0	53
07.312.9355.0	70	07.340.3553.0	51	39.703.0253.0	110	56.399.1255.0	53
07.312.9455.0	70	07.340.3653.0	51	39.703.0253.6	110	56.503.7355.0	26
07.312.9455.0	78	07.340.3753.0	51	39.703.0253.9	110	56.503.7455.0	26
07.312.9455.6	70	07.340.3753.0	51	54.003.7553.0	57	56.503.7555.0	26
07.312.9555.0	70	07.431.7053.8	48	54.003.7553.6	57	56.503.7655.0	26
07.312.9655.0	91	07.431.7153.8	48	54.004.7553.0	57	56.503.8355.0	25

# Index

56.503.8455.0	25	56.704.0055.0	70	57.503.2855.0	34	57.904.6655.0	32
56.503.8555.0	25	56.704.0055.6	70	57.503.3055.6	34	57.904.6755.0	32
56.702.0053.0	66	56.704.4055.0	94	57.503.7055.0	27	57.904.6855.0	32
56.702.0053.6	66	56.704.4055.0	94	57.503.7155.0	27	57.904.7055.0	38
56.702.2053.0	102	56.704.4055.0	95	57.503.7255.0	27	57.904.7155.0	38
56.702.5053.0	66	56.704.4055.0	95	57.503.7855.0	26	57.904.7255.0	38
56.702.5053.6	66	56.704.4155.0	96	57.503.7955.0	26	57.904.7355.0	38
56.702.5153.0	66	56.704.4255.0	96	57.503.8055.0	26	57.904.7455.0	38
56.702.5153.6	66	56.704.5055.0	70	57.503.8855.0	25	57.910.4955.0	33
56.702.6953.1	82	56.704.5055.6	70	57.503.8955.0	25	57.910.5055.0	33
56.702.7053.0	103	56.704.5155.0	70	57.503.9055.0	25	57.910.5155.0	33
56.702.7653.0	82	56.704.5155.6	70	57.504.1655.0	30	57.910.5255.0	33
56.702.9053.0	76	56.704.5355.0	96	57.504.1755.0	30	57.910.5355.0	33
56.702.9153.0	76	56.704.6955.1	90	57.504.2055.0	30	57.910.5455.0	33
56.702.9253.0	82	56.704.7055.0	90	57.504.2055.6	30	57.910.5755.0	33
56.702.9353.0	76	56.704.7155.5	91	57.504.2355.0	30	57.910.5855.0	33
56.703.0055.0	68	56.704.7155.9	91	57.504.3655.0	37	57.910.6155.0	33
56.703.0055.6	68	56.704.7355.5	91	57.504.3755.0	37	58.503.0055.0	12
56.703.0553.0	113	56.704.7555.5	91	57.504.4055.0	28	58.503.0055.6	12
56.703.0553.6	113	56.704.7555.9	91	57.504.4055.0	28	58.503.2055.0	21
56.703.0553.7	113	56.704.7655.0	90	57.504.4055.0	29	58.503.2055.6	21
56.703.0553.9	113	56.704.7755.0	91	57.504.4055.0	29	58.503.2155.0	21
56.703.1053.0	113	56.704.7855.0	91	57.504.4455.0	31	58.503.2155.6	21
56.703.1053.6	113	56.704.7955.5	91	57.504.4555.0	31	58.503.2355.0	21
56.703.1053.7	113	56.704.8055.9	91	57.504.4855.0	31	58.503.9055.0	16
56.703.1053.9	113	56.704.8255.5	91	57.504.6255.0	36	58.504.0055.0	12
56.703.2053.0	102	56.704.8355.5	91	57.504.6355.0	36	58.504.0055.6	12
56.703.2053.6	102	56.704.8453.0	89	57.504.7355.0	36	58.504.2055.0	21
56.703.2155.0	100	56.704.9055.0	78	57.506.0555.0	44	58.504.2055.6	21
56.703.2155.6	100	56.704.9155.0	78	57.510.0555.0	44	58.504.2355.0	21
56.703.2255.0	100	56.704.9255.0	90	57.535.0155.0	14	58.504.4155.0	21
56.703.2355.0	100	56.704.9355.0	78	57.535.0155.6	14	58.504.5055.0	20
56.703.2355.6	100	56.704.XX55.5	91	57.535.9055.0	18	58.504.5055.6	20
56.703.2455.0	100	56.704.XX55.9	91	57.570.0155.0	14	58.504.5155.0	20
56.703.2955.1	88	56.706.0055.0	72	57.570.0155.6	14	58.504.5155.6	20
56.703.3055.0	88	56.706.0055.6	72	57.570.9055.0	18	58.504.6955.1	23
56.703.3255.0	89	56.706.5055.0	72	57.570.9855.0	15	58.504.7055.0	23
56.703.3355.0	89	56.706.5055.6	72	57.570.9955.0	15	58.504.7055.6	23
56.703.3455.0	100	56.706.9055.0	79	57.597.0155.0	14	58.504.7255.9	24
56.703.3555.1	100	56.706.9355.0	79	57.597.0155.6	14	58.504.7355.9	24
56.703.3655.0	100	56.710.0055.0	73	57.597.9855.0	15	58.504.7455.9	24
56.703.5055.0	68	56.710.0055.0	75	57.597.9955.0	15	58.504.7955.9	24
56.703.5055.6	68	56.710.0055.6	73	57.904.0055.0	38	58.504.8055.9	24
56.703.5155.0	68	56.710.0055.6	75	57.904.0155.0	38	58.504.8155.9	24
56.703.5155.6	68	56.710.5055.0	73	57.904.0255.0	38	58.504.8255.9	24
56.703.5355.0	92	56.710.5055.0	75	57.904.0355.0	38	58.504.8355.9	24
56.703.5455.0	92	56.710.5055.6	73	57.904.0455.0	38	58.504.8755.9	24
56.703.5555.0	92	56.710.5055.6	75	57.904.0555.0	38	58.504.8855.9	24
56.703.5955.1	86	56.710.9055.0	80	57.904.0655.0	38	58.504.9055.0	16
56.703.6055.0	86	56.710.9355.0	80	57.904.0755.0	38	58.504.9155.0	20
56.703.6155.0	87	56.716.0055.0	74	57.904.0855.0	38	58.504.9255.0	23
56.703.6255.0	86	56.716.0055.6	74	57.904.0955.0	38	58.504.9355.0	20
56.703.6355.0	86	56.716.0353.0	69	57.904.1055.0	38	58.504.XX55.9	24
56.703.6455.0	87	56.716.0353.0	71	57.904.1155.0	38	58.506.0055.0	12
56.703.6555.0	93	56.716.0353.0	97	57.904.2055.0	38	58.506.0055.6	12
56.703.6655.0	93	56.716.5055.0	74	57.904.2555.0	38	58.506.9055.0	16
56.703.6955.1	84	56.716.5055.6	74	57.904.2855.0	38	58.510.0055.0	13
56.703.7055.0	84	56.716.9055.0	80	57.904.3955.0	38	58.510.0055.6	13
56.703.7155.5	85	56.716.9355.0	81	57.904.4155.0	38	58.510.9055.0	17
56.703.7155.9	85	56.735.0053.0	74	57.904.4255.0	38	58.516.0055.0	13
56.703.7355.5	85	56.735.0053.0	75	57.904.4355.0	38	58.516.0055.6	13
56.703.7555.5	85	56.735.0053.6	74	57.904.4455.0	38	58.516.9055.0	17
56.703.7555.9	85	56.735.0053.6	75	57.904.4555.0	38	59.903.0155.0	101
56.703.7655.0	84	56.735.9053.0	81	57.904.4655.0	38	59.903.0255.0	101
56.703.7755.0	85	57.016.5055.0	45	57.904.4755.0	38	59.903.0355.0	101
56.703.7855.0	85	57.106.1055.0	45	57.904.4855.0	38	59.903.0455.0	101
56.703.7955.5	85	57.106.1155.0	45	57.904.4955.0	38	59.903.0555.0	101
56.703.8055.9	85	57.110.1555.0	39	57.904.5055.0	38	59.903.0655.0	101
56.703.8255.5	85	57.110.1655.0	39	57.904.5155.0	38	59.903.0755.0	101
56.703.8355.5	85	57.403.6955.1	22	57.904.5355.0	32	59.903.0855.0	101
56.703.8855.0	88	57.403.7055.0	22	57.904.5455.0	32	59.903.0955.0	101
56.703.8955.0	84	57.503.2055.0	34	57.904.5555.0	32	59.903.1055.0	101
56.703.9055.0	77	57.503.2155.0	34	57.904.5655.0	32	69.700.0953.0	107
56.703.9155.0	77	57.503.2255.0	34	57.904.5755.0	32	69.700.1853.0	107
56.703.9253.0	102	57.503.2355.0	34	57.904.5855.0	32	69.920.0553.0	132
56.703.9355.0	77	57.503.2555.6	34	57.904.6355.0	32	69.920.0653.0	133
56.703.XX55.5	85	57.503.2655.0	34	57.904.6455.0	32	69.920.0753.0	133
56.703.XX55.9	85	57.503.2755.0	34	57.904.6555.0	32	69.920.1053.0	132

69.920.1253.0	132	Z1.298.1653.0	94	Z5.523.9453.0	132	Z7.220.0227.0	36
95.101.1100.0	143	Z1.298.1753.0	28	Z5.553.2921.0	69	Z7.220.0227.0	36
95.101.1200.0	143	Z1.298.1753.0	94	Z5.553.2921.0	71	Z7.220.0627.0	36
95.101.1300.0	143	Z1.298.1853.0	28	Z5.553.2921.0	72	Z7.250.5227.0	45
95.300.0500.0	142	Z1.298.1853.0	94	Z5.553.2921.0	73	Z7.250.5227.0	45
95.350.0100.0	143	Z1.298.1953.0	28	Z5.553.2921.0	75	Z7.250.5327.0	45
95.502.0100.0	135	Z1.298.1953.0	94	Z5.553.2921.0	78	Z7.250.5327.0	45
95.502.0118.0	135	Z1.298.2053.0	94	Z5.553.2921.0	79	Z7.250.5427.0	45
95.502.0125.0	135	Z1.299.3055.0	29	Z5.553.2921.0	81	Z7.250.5427.0	45
95.502.0125.1	135	Z1.299.3055.0	95	Z5.553.2921.0	81	Z7.255.0227.0	140
95.502.0135.0	135	Z1.299.3155.0	29	Z5.553.2921.0	87	Z7.255.0227.0	140
95.502.0135.1	135	Z1.299.3155.0	95	Z5.553.2921.0	93	Z7.255.4227.0	29
95.502.0150.0	135	Z1.299.3255.0	29	Z5.553.2921.0	94	Z7.255.4227.0	31
95.502.0170.0	135	Z1.299.3255.0	95	Z5.553.2921.0	95	Z7.255.4227.0	140
95.502.0197.0	135	Z1.299.3355.0	29	Z5.553.2921.0	119	Z7.255.4227.0	140
95.502.0198.0	135	Z1.299.3355.0	95	Z5.553.2921.0	119	Z7.255.4327.0	29
95.502.0199.0	135	Z1.299.4055.0	29	Z5.553.2921.0	121	Z7.255.4327.0	31
95.502.0225.1	135	Z1.299.4055.0	95	Z5.553.2921.0	121	Z7.255.4627.0	29
95.502.0235.1	135	Z1.299.4155.0	29	Z5.553.2921.0	123	Z7.255.4627.0	31
95.502.0604.0	135	Z1.299.4155.0	95	Z5.553.2921.0	141	Z7.255.8227.0	41
95.502.0607.0	135	Z1.299.4255.0	29	Z5.553.2921.1	141	Z7.255.8227.0	140
95.502.0612.0	135	Z1.299.4255.0	95	Z5.553.2921.6	141	Z7.255.8327.0	41
95.502.0613.0	135	Z1.299.9753.0	13	Z5.553.3121.0	141	Z7.255.8327.0	140
95.502.0620.0	135	Z1.299.9753.0	69	Z7.211.0027.0	57	Z7.255.8427.0	41
95.502.0625.0	135	Z1.299.9753.0	71	Z7.211.0227.0	36	Z7.255.8527.0	41
95.502.0627.0	135	Z1.299.9753.0	87	Z7.211.0227.0	57	Z7.255.8627.0	41
95.502.0628.0	135	Z1.299.9753.0	93	Z7.211.0327.0	36	Z7.256.8427.0	140
95.502.0700.0	135	Z1.299.9753.0	101	Z7.211.0327.0	57	Z7.256.8527.0	140
95.502.0710.0	135	Z1.299.9753.0	119	Z7.211.0427.0	57	Z7.256.8527.0	140
95.502.0710.2	135	Z1.299.9753.0	121	Z7.211.0527.0	57	Z7.260.0029.0	109
95.502.0710.3	135	Z1.299.9753.0	123	Z7.211.0627.0	36	Z7.260.0229.0	109
95.502.0710.4	135	Z1.299.9753.0	141	Z7.211.0627.0	57	Z7.260.0329.0	109
95.502.0710.5	135	Z1.980.0040.0	128	Z7.212.0227.0	58	Z7.260.0429.0	109
95.502.0710.7	135	Z1.980.0253.0	129	Z7.212.0327.0	58	Z7.260.0529.0	109
95.502.0711.0	135	Z2.302.0421.0	19	Z7.212.0427.0	58	Z7.260.1029.0	109
98.090.0000.0	131	Z2.302.0621.0	19	Z7.212.0527.0	58	Z7.261.1027.0	97
98.090.0015.0	131	Z2.302.1321.0	128	Z7.212.0627.0	58	Z7.261.1127.0	85
98.190.0000.0	131	Z2.803.3010.0	128	Z7.212.1227.0	43	Z7.261.1127.0	87
98.190.1000.0	131	Z2.803.3110.0	128	Z7.212.1327.0	43	Z7.261.1127.0	89
98.210.0000.0	131	Z2.803.3210.0	128	Z7.212.1427.0	43	Z7.261.1127.0	91
98.220.0000.0	131	Z2.803.3310.0	128	Z7.212.1527.0	43	Z7.261.1127.0	123
98.290.1000.0	129	Z2.803.4010.0	128	Z7.212.2027.0	43	Z7.261.1127.0	140
98.300.0000.0	130	Z2.803.4110.0	128	Z7.212.2227.0	43	Z7.261.1227.0	12
98.300.0010.0	130	Z2.803.4210.0	128	Z7.212.2327.0	43	Z7.261.1227.0	20
98.300.1000.0	130	Z2.803.4310.0	128	Z7.212.2427.0	43	Z7.261.1227.0	20
98.360.0000.0	130	Z2.803.5010.0	128	Z7.213.0227.0	59	Z7.261.1227.0	21
98.360.0004.0	130	Z2.803.5110.0	128	Z7.213.0327.0	59	Z7.261.1227.0	21
98.370.0000.0	130	Z2.803.5210.0	128	Z7.213.0427.0	59	Z7.261.1227.0	23
98.370.1000.0	130	Z2.803.5310.0	128	Z7.213.0527.0	59	Z7.261.1227.0	23
98.370.1001.0	130	Z2.803.6010.0	128	Z7.213.0627.0	59	Z7.261.1227.0	71
98.375.1000.0	130	Z2.803.6110.0	128	Z7.214.0227.0	58	Z7.261.1227.0	91
98.380.0000.0	130	Z2.803.6210.0	128	Z7.214.0327.0	58	Z7.261.1227.0	94
98.400.0000.0	128	Z4.242.5053.0	136	Z7.214.0427.0	58	Z7.261.1227.0	95
99.013.9999.9	140	Z4.242.5153.0	136	Z7.214.0527.0	58	Z7.261.1227.0	97
99.014.9999.9	140	Z4.242.6053.0	136	Z7.214.0627.0	58	Z7.261.1227.0	140
99.015.9999.9	140	Z4.242.6353.0	136	Z7.215.0027.0	57	Z7.261.1327.0	12
99.031.9999.9	140	Z4.242.8053.0	136	Z7.215.0227.0	57	Z7.261.1327.0	20
99.032.9999.9	140	Z4.243.2053.0	136	Z7.215.0327.0	57	Z7.261.1327.0	20
99.033.9999.9	140	Z4.243.2053.0	136	Z7.215.0427.0	57	Z7.261.1327.0	23
99.034.9999.9	140	Z4.243.8453.0	132	Z7.215.0527.0	57	Z7.261.1327.0	23
Z1.110.8855.0	101	Z5.511.3553.0	41	Z7.215.0627.0	57	Z7.261.1327.0	71
Z1.110.8855.6	101	Z5.511.3553.6	41	Z7.215.4027.0	54	Z7.261.1327.0	91
Z1.110.8855.7	101	Z5.511.3553.7	41	Z7.215.4027.0	55	Z7.261.1327.0	94
Z1.110.8955.0	101	Z5.511.3553.8	41	Z7.215.4027.0	55	Z7.261.1327.0	95
Z1.110.8955.6	101	Z5.511.3553.9	41	Z7.215.4227.0	54	Z7.261.1327.0	97
Z1.110.8955.7	101	Z5.515.3310.0	129	Z7.215.4227.0	55	Z7.261.1327.0	140
Z1.110.9055.0	101	Z5.515.3410.0	129	Z7.215.4227.0	55	Z7.261.1427.0	12
Z1.110.9055.6	101	Z5.516.2511.0	131	Z7.215.4327.0	54	Z7.261.1427.0	20
Z1.110.9055.7	101	Z5.516.2711.0	131	Z7.215.4327.0	55	Z7.261.1427.0	20
Z1.298.1053.0	28	Z5.516.2811.0	131	Z7.215.4327.0	55	Z7.261.1427.0	23
Z1.298.1053.0	94	Z5.519.0310.0	129	Z7.215.4627.0	54	Z7.261.1427.0	23
Z1.298.1153.0	28	Z5.519.0410.0	129	Z7.215.4627.0	55	Z7.261.1427.0	71
Z1.298.1153.0	94	Z5.522.5010.0	133	Z7.215.4627.0	55	Z7.261.1427.0	91
Z1.298.1253.0	28	Z5.522.7553.0	133	Z7.216.0227.0	59	Z7.261.1427.0	94
Z1.298.1253.0	94	Z5.522.8553.0	132	Z7.216.0327.0	59	Z7.261.1427.0	95
Z1.298.1353.0	28	Z5.523.5653.0	133	Z7.216.0427.0	59	Z7.261.1427.0	97
Z1.298.1353.0	94	Z5.523.5753.0	133	Z7.216.0527.0	59	Z7.261.1427.0	140
Z1.298.1653.0	28	Z5.523.9353.0	132	Z7.216.0627.0	59	Z7.261.1527.0	12

Z7.261.1527.0	20	Z7.268.2027.0	83	Z7.280.6527.0	121	Z7.282.5327.0	12
Z7.261.1527.0	20	Z7.268.2027.0	140	Z7.280.6527.0	123	Z7.282.5327.0	72
Z7.261.1527.0	21	Z7.269.2923.0	57	Z7.280.6527.0	140	Z7.282.5327.0	79
Z7.261.1527.0	21	Z7.269.3023.0	58	Z7.280.6627.0	69	Z7.282.5327.0	119
Z7.261.1527.0	23	Z7.269.3123.0	58	Z7.280.6627.0	93	Z7.282.5327.0	121
Z7.261.1527.0	23	Z7.269.3223.0	59	Z7.280.6627.0	101	Z7.282.5427.0	12
Z7.261.1527.0	71	Z7.269.3423.0	59	Z7.280.6627.0	103	Z7.282.5427.0	72
Z7.261.1527.0	91	Z7.269.3523.0	57	Z7.280.6627.0	119	Z7.282.5427.0	79
Z7.261.1527.0	94	Z7.270.0227.0	25	Z7.280.6627.0	121	Z7.282.5427.0	119
Z7.261.1527.0	95	Z7.270.0227.0	26	Z7.280.6627.0	123	Z7.282.5427.0	121
Z7.261.1527.0	97	Z7.270.0327.0	25	Z7.280.6627.0	140	Z7.282.5527.0	12
Z7.261.1527.0	140	Z7.270.0327.0	26	Z7.280.6727.0	69	Z7.282.5527.0	72
Z7.261.1627.0	71	Z7.270.1227.0	25	Z7.280.6727.0	93	Z7.282.5527.0	79
Z7.261.1627.0	91	Z7.270.1227.0	26	Z7.280.6727.0	101	Z7.282.5527.0	119
Z7.261.1627.0	94	Z7.271.2227.0	54	Z7.280.6727.0	103	Z7.282.5527.0	121
Z7.261.1627.0	95	Z7.271.2327.0	54	Z7.280.6727.0	119	Z7.282.5527.0	140
Z7.261.1627.0	97	Z7.271.3227.0	54	Z7.280.6727.0	121	Z7.282.6229.0	41
Z7.261.1627.0	140	Z7.271.4227.0	37	Z7.280.6727.0	123	Z7.282.6329.0	41
Z7.261.1727.0	71	Z7.271.4327.0	37	Z7.280.6727.0	140	Z7.282.6429.0	41
Z7.261.1727.0	91	Z7.271.5227.0	37	Z7.280.6827.0	69	Z7.282.6529.0	41
Z7.261.1727.0	94	Z7.280.0227.0	27	Z7.280.6827.0	93	Z7.282.6629.0	41
Z7.261.1727.0	95	Z7.280.0327.0	27	Z7.280.6827.0	101	Z7.282.7229.0	41
Z7.261.1727.0	97	Z7.280.0627.0	27	Z7.280.6827.0	103	Z7.282.7329.0	41
Z7.261.1727.0	140	Z7.280.2227.0	22	Z7.280.6827.0	119	Z7.282.7429.0	41
Z7.261.1827.0	71	Z7.280.2227.0	35	Z7.280.6827.0	121	Z7.283.2227.0	44
Z7.261.1827.0	91	Z7.280.2327.0	22	Z7.280.6827.0	123	Z7.283.2227.0	45
Z7.261.1827.0	94	Z7.280.2327.0	35	Z7.280.6827.0	140	Z7.283.2327.0	44
Z7.261.1827.0	95	Z7.280.3227.0	22	Z7.280.6927.0	69	Z7.283.2327.0	45
Z7.261.1827.0	97	Z7.280.3227.0	35	Z7.280.6927.0	93	Z7.283.3227.0	44
Z7.261.1827.0	140	Z7.280.6227.0	12	Z7.280.6927.0	101	Z7.283.3227.0	45
Z7.261.1927.0	71	Z7.280.6227.0	21	Z7.280.6927.0	103	Z7.283.8227.0	13
Z7.261.1927.0	91	Z7.280.6227.0	69	Z7.280.6927.0	119	Z7.283.8227.0	73
Z7.261.1927.0	94	Z7.280.6227.0	85	Z7.280.6927.0	121	Z7.283.8227.0	81
Z7.261.1927.0	95	Z7.280.6227.0	87	Z7.280.6927.0	123	Z7.283.8227.0	140
Z7.261.1927.0	97	Z7.280.6227.0	89	Z7.280.6927.0	140	Z7.284.4227.0	13
Z7.261.1927.0	140	Z7.280.6227.0	93	Z7.280.7027.0	12	Z7.284.4227.0	74
Z7.261.2027.0	12	Z7.280.6227.0	101	Z7.280.7027.0	21	Z7.284.4227.0	74
Z7.261.2027.0	20	Z7.280.6227.0	103	Z7.280.7027.0	69	Z7.284.4227.0	81
Z7.261.2027.0	20	Z7.280.6227.0	119	Z7.280.7027.0	85	Z7.284.4227.0	140
Z7.261.2027.0	21	Z7.280.6227.0	121	Z7.280.7027.0	87	Z7.285.2227.0	14
Z7.261.2027.0	21	Z7.280.6227.0	123	Z7.280.7027.0	89	Z7.285.2327.0	14
Z7.261.2027.0	23	Z7.280.6227.0	140	Z7.280.7027.0	93	Z7.285.2627.0	14
Z7.261.2027.0	23	Z7.280.6327.0	12	Z7.280.7027.0	101	Z7.285.3227.0	14
Z7.261.2027.0	71	Z7.280.6327.0	69	Z7.280.7027.0	103	Z7.285.6227.0	74
Z7.261.2027.0	91	Z7.280.6327.0	85	Z7.280.7027.0	119	Z7.285.6227.0	81
Z7.261.2027.0	94	Z7.280.6327.0	87	Z7.280.7027.0	121	Z7.285.6227.0	140
Z7.261.2027.0	95	Z7.280.6327.0	89	Z7.280.7027.0	123	Z7.285.6427.0	73
Z7.261.2027.0	140	Z7.280.6327.0	93	Z7.280.7027.0	140	Z7.285.6427.0	75
Z7.267.0227.5	25	Z7.280.6327.0	101	Z7.280.8027.0	12	Z7.285.6427.0	140
Z7.267.0227.5	26	Z7.280.6327.0	103	Z7.280.8027.0	21	Z7.286.3227.0	14
Z7.267.0227.6	25	Z7.280.6327.0	119	Z7.280.8027.0	69	Z7.286.3327.0	14
Z7.267.0227.6	26	Z7.280.6327.0	121	Z7.280.8027.0	85	Z7.286.3627.0	14
Z7.267.0327.5	25	Z7.280.6327.0	123	Z7.280.8027.0	87	Z7.287.0227.0	32
Z7.267.0327.5	26	Z7.280.6327.0	140	Z7.280.8027.0	89	Z7.287.0327.0	32
Z7.267.0327.6	25	Z7.280.6427.0	12	Z7.280.8027.0	93	Z7.287.0627.0	32
Z7.267.0327.6	26	Z7.280.6427.0	69	Z7.280.8027.0	101	Z7.287.1227.0	14
Z7.267.1227.5	25	Z7.280.6427.0	85	Z7.280.8027.0	103	Z7.287.1327.0	14
Z7.267.1227.5	26	Z7.280.6427.0	87	Z7.280.8027.0	119	Z7.287.1627.0	14
Z7.267.1227.6	25	Z7.280.6427.0	89	Z7.280.8027.0	121	Z7.311.1755.0	139
Z7.267.1227.6	26	Z7.280.6427.0	93	Z7.280.8027.0	123	Z7.311.2755.0	139
Z7.268.0227.0	67	Z7.280.6427.0	101	Z7.280.8027.0	140	Z7.311.7055.0	139
Z7.268.0227.0	83	Z7.280.6427.0	103	Z7.281.1227.0	37	Z7.409.5753.0	52
Z7.268.0227.0	140	Z7.280.6427.0	119	Z7.281.1327.0	37	Z7.409.5853.0	52
Z7.268.0327.0	67	Z7.280.6427.0	121	Z7.281.2227.0	37	Z7.409.5853.0	53
Z7.268.0327.0	83	Z7.280.6427.0	123	Z7.281.3227.0	36	Z7.409.5853.0	53
Z7.268.0327.0	140	Z7.280.6427.0	140	Z7.281.3327.0	36		
Z7.268.0427.0	67	Z7.280.6527.0	12	Z7.281.3627.0	36		
Z7.268.0427.0	83	Z7.280.6527.0	21	Z7.282.2227.0	44		
Z7.268.0427.0	140	Z7.280.6527.0	69	Z7.282.2327.0	44		
Z7.268.0527.0	67	Z7.280.6527.0	85	Z7.282.3227.0	44		
Z7.268.0527.0	83	Z7.280.6527.0	87	Z7.282.5227.0	12		
Z7.268.0527.0	140	Z7.280.6527.0	89	Z7.282.5227.0	72		
Z7.268.1027.0	67	Z7.280.6527.0	93	Z7.282.5227.0	79		
Z7.268.1027.0	83	Z7.280.6527.0	101	Z7.282.5227.0	119		
Z7.268.1027.0	140	Z7.280.6527.0	103	Z7.282.5227.0	121		
Z7.268.2027.0	67	Z7.280.6527.0	119	Z7.282.5227.0	140		

# Selection of our catalogs



**0510.0 selos<sup>BIT</sup> / fasis<sup>BIT</sup>**  
DIN Rail Terminal Blocks  
for Junction Boxes



**0670.1 gesis<sup>®</sup>**  
Pluggable electrical  
installation for indoors



**0690.1 gesis<sup>®</sup>RST<sup>®</sup>**  
Pluggable electrical installation  
in highest protection (IP6X)



**0700.1 gesis<sup>®</sup> ELECTRONIC**  
Decentralized building  
automation with plug & play



**0530.1 revos**  
Industrial Multipole  
Connectors



**0800.1 interface**  
Solutions for the  
Control Cabinet



**0860.1 safety**  
System Solutions for  
Automation Technology



**0550.1 wiecon**  
Printed Circuit Board  
Terminals



**0415.1 Machine building**  
Individual customer  
solutions

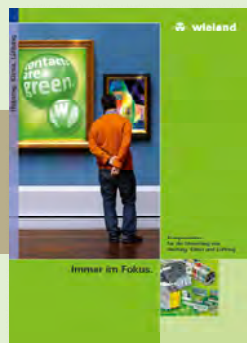

**0402.1 Components for heating,  
ventilation, and air  
conditioning**



**0406.1 Solutions for heavy duty  
construction equipment  
and vehicles**



**0416.1 Lift Technologie**  
Solutions for the  
electrical installation



**0902.1 The system partner in  
automation technology and  
in building automation  
technology**



**0912.0 Wieland apprenticeship**  
Auf der Erfolgsstraße.

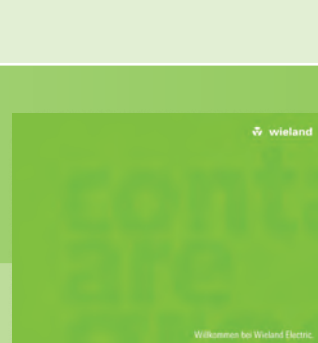

**0950.1 Wieland Image brochure**

## Wieland Hotline and consultation



### Hotline – one call is all it takes

Naturally our service employees are available to you at any time.

#### Industrial Automation - Electromechanical

Hotline **+49 951 9324-991**  
E-Mail **AT.TS@wieland-electric.com**

#### Industrial Automation - Electronics

Hotline **+49 951 9324-995**  
E-Mail **AT.TS@wieland-electric.com**

#### Safety

Hotline **+49 951 9324-999**  
E-Mail **safety@wieland-electric.com**



General information and news:  
[www.wieland-electric.com](http://www.wieland-electric.com)

Visit our e-catalog at  
<http://eshop.wieland-electric.com>



## Our subsidiaries

... and the addresses of our sales partner worldwide are available at:  
[www.wieland-electric.com](http://www.wieland-electric.com)



**USA**  
**Wieland Electric Inc.**  
**North American Headquarters**  
 2889 Brighton Road  
 Oakville, Ontario L6H 6C9  
 Phone +1 905 8298414  
 Fax +1 905 8298413  
[www.wielandinc.com](http://www.wielandinc.com)



**CANADA**  
**Wieland Electric Inc.**  
**North American Headquarters**  
 2889 Brighton Road  
 Oakville, Ontario L6H 6C9  
 Phone +1 905 8298414  
 Fax +1 905 8298413  
[www.wieland-electric.ca](http://www.wieland-electric.ca)



**GREAT BRITAIN**  
**Wieland Electric Ltd.**  
 Riverside Business Center,  
 Walnut Tree Close  
 GB-Guildford/Surrey GU1 4UG  
 Phone +44 1483 531213  
 Fax +44 1483 505029  
[sales.uk@wieland-electric.com](mailto:sales.uk@wieland-electric.com)  
[www.wieland-electric.co.uk](http://www.wieland-electric.co.uk)



**FRANCE**  
**Wieland Electric SARL.**  
 Le Cérame, Hall 6  
 47, avenue des Genottes  
 CS 48313  
 95803 Cergy-Pontoise Cedex  
 Phone +33 1 30320707  
 Fax +33 1 30320714  
[info.adv@wieland-electric.com](mailto:info.adv@wieland-electric.com)  
[www.wieland-electric.fr](http://www.wieland-electric.fr)



**SPAIN**  
**Wieland Electric S.L.**  
 C/ Maria Auxiliadora 2, bajos  
 E-08017 Barcelona  
 Phone +34 93 2523820  
 Fax +34 93 2523825  
[ventas@wieland-electric.com](mailto:ventas@wieland-electric.com)  
[www.wieland-electric.es](http://www.wieland-electric.es)



**ITALY**  
**Wieland Electric S.r.l.**  
 Via Edison, 209  
 I-20019 Settimo Milanese  
 Phone +39 02 48916357  
 Fax +39 02 48920685  
[info.italy@wieland-electric.com](mailto:info.italy@wieland-electric.com)  
[www.wieland-electric.it](http://www.wieland-electric.it)



**BELGIUM**  
**ATEM-Wieland Electric NV**  
 Bedrijvenpark De Veert 4  
 B-2830 Willebroek  
 Phone +32 3 8661800  
 Fax +32 3 8661828  
[info.belgium@wieland-electric.com](mailto:info.belgium@wieland-electric.com)  
[www.wieland-electric.be](http://www.wieland-electric.be)



**DENMARK**  
**Wieland Electric A/S**  
 Vallørækken 26  
 DK-4600 Køge  
 Phone +45 70 266635  
 Fax +45 70 266637  
[sales.denmark@wieland-electric.com](mailto:sales.denmark@wieland-electric.com)  
[www.wieland-electric.dk](http://www.wieland-electric.dk)



**SWITZERLAND**  
**Wieland Electric AG**  
 Harzachstrasse 2b  
 CH-8404 Winterthur  
 Phone +41 52 2352100  
 Fax +41 52 2352119  
[info.swiss@wieland-electric.com](mailto:info.swiss@wieland-electric.com)  
[www.wieland-electric.ch](http://www.wieland-electric.ch)



**POLAND**  
**Wieland Electric Sp. Zo.o.**  
 Św. Antoniego 8  
 62-080 Swadzim  
 Phone +48 61 2225400  
 Fax +48 61 8407166  
[office@wieland-electric.pl](mailto:office@wieland-electric.pl)  
[www.wieland-electric.pl](http://www.wieland-electric.pl)



**CHINA**  
**Wieland Electric Trading**  
 Unit 2703 International Soho City  
 889 Renmin Road,  
 Huang Pu District  
 PRC- Shanghai 200010  
 Phone +86 21 63555833  
 Fax +86 21 63550090  
[info-shanghai@wieland-electric.com](mailto:info-shanghai@wieland-electric.com)  
[www.wieland-electric.cn](http://www.wieland-electric.cn)



**JAPAN**  
**Wieland Electric Co, Ltd.**  
 Nisso No. 16 Bldg. 7F  
 3-8-8 Shin-Yokohama,  
 Kohoku-ku  
 Yokohama 222-0033  
 Phone +81 45 473 5085  
 Fax +81 45 470 5408  
[info.japan@wieland-electric.com](mailto:info.japan@wieland-electric.com)



**GERMANY**  
**Headquarters**  
**Wieland Electric GmbH**  
 Brennerstraße 10 – 14  
 96052 Bamberg, Germany  
 Phone +49 951 9324-0  
 Fax +49 951 9324-198  
[info@wieland-electric.com](mailto:info@wieland-electric.com)  
[www.wieland-electric.de](http://www.wieland-electric.de)

Subject to technical modifications! **gesis**®, **RST**®, **GST**®, **GST18**®, **podis**® and **samos**® are registered trademarks of Wieland Electric GmbH



Headquarters:  
Wieland Electric GmbH  
Brennerstraße 10 – 14  
96052 Bamberg, Germany

Phone +49 951 9324-0  
Fax +49 951 9324-198  
info@wieland-electric.com  
www.wieland-electric.com

## Industrial technology

### Solutions for the control cabinet

- DIN rail terminal blocks
  - Screw, tension spring or push-in connection technology
  - Wire cross sections up to 300 mm<sup>2</sup>
  - Numerous special functions
  - Software solutions interfacing to CAE systems
- Safety
  - Safe signal acquisition
  - Safety switching devices
  - Modular safety modules
  - Compact safety controllers
  - Application consulting and training
- Network engineering and fieldbus systems
  - Remote maintenance via VPN industrial router and VPN service portal
  - Industrial Ethernet switches
  - PLC and I/O systems, standard and increased environmental conditions
- Interface
  - Power supply units
  - Overvoltage protection
  - Coupling relays, semiconductor switches
  - Timer relays, measuring and monitoring relays
  - Analog coupling and converter modules
  - Passive interfaces

### Solutions for field applications

- Decentralized installation and automation technology
  - Electrical installation for wind tower
  - Fieldbus interfaces and motor starters
- Connectors for industrial applications
  - Rectangular and round connectors
  - Aluminium or plastic housings
  - Degree of protection up to IP 69K
  - Current-carrying capacity up to 100 A
  - Connectors for hazardous areas
  - Modular, application-specific technology

### PC board terminals and connectors

- Screw or spring clamp connection technology
- Spacings: 3.5 mm to 10.16 mm
- Reflow or wave soldering process

## Building and installation technology

- Building installation systems
  - Main power supply connectors IP 20/IP 65 ... IP 69K
  - Bus connectors
  - Low-voltage connectors
  - Power distribution system with flat cables
  - Distribution systems
  - Room automation with KNX and wireless technology
  - DIN rail terminal blocks for electrical installations
  - Overvoltage protection