

ACDBMT140-HF Thru. ACDBMT1200-HF

Reverse Voltage: 40 to 200 Volts

Forward Current: 1.0 Amp

RoHS Device

Halogen Free

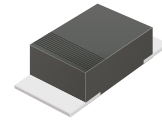

Features

- Excellent power dissipation offers better reverse leakage current and thermal resistance.
- Low profile surface mounted application in order to optimize board space.
- Low power loss, high efficiency.
- High current capability, low forward voltage drop.
- High surge capability.
- Guarding for overvoltage protection.
- Ultra high-speed switching.
- Silicon epitaxial planar chip, metal silicon junction.
- Lead-free part meets environmental standards of MIL-STD-19500/228
- Comply with AEC-Q101.

Mechanical data

- Epoxy: UL94-V0 rated flame retardant.
- Case: Molded plastic, SOD-123H/MINI SMA
- Terminals: Solderable per MIL-STD-750, method 2026.
- Polarity: Indicated by cathode band.
- Mounting Position: any
- Weight: 0.011 grams approx.

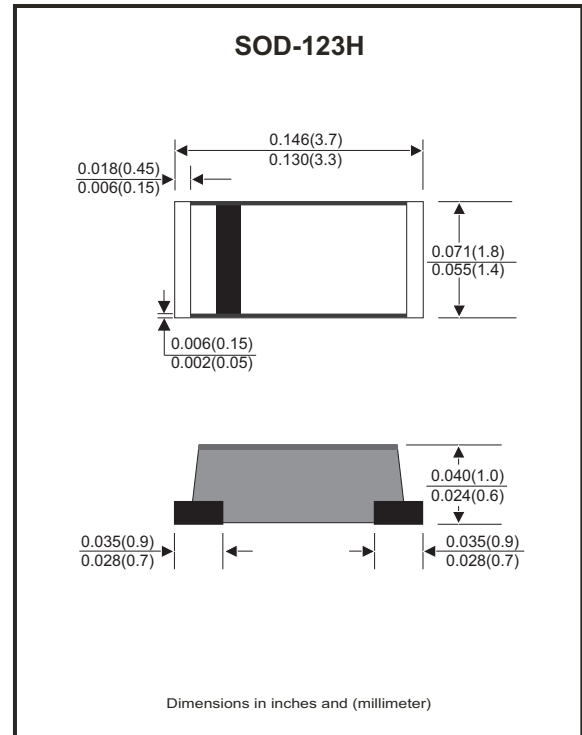

Maximum Ratings and Electrical Characteristics (at $T_A=25^\circ\text{C}$ unless otherwise noted)

Parameter	Symbol	ACDBMT 140-HF	ACDBMT 160-HF	ACDBMT 1100-HF	ACDBMT 1150-HF	ACDBMT 1200-HF	Units
Repetitive peak reverse voltage	V_{RRM}	40	60	100	150	200	V
RMS voltage	V_{RMS}	28	42	70	105	140	V
Continuous reverse voltage	V_R	40	60	100	150	200	V
Max. forward voltage @ $I_F=1.0A$	V_F	0.50	0.70	0.85	0.90	0.92	V
Operating Temperature	T_J	-55 to +125	-55 to +150				$^\circ\text{C}$

Parameter	Conditions	Symbol	MIN.	TYP.	MAX.	Units
Forward rectified current	see Fig.1	I_o			1.0	A
Forward surge current	8.3ms single half sine-wave superimposed on rate load (JEDEC method)	I_{FSM}			30	A
Reverse Current	$V_R = V_{RRM}$ $T_J=25^\circ\text{C}$	I_R			0.5	mA
	$V_R = V_{RRM}$ $T_J=100^\circ\text{C}$	I_R			10	mA
Thermal resistance	Junction to case	$R_{\theta JC}$		40		$^\circ\text{C/W}$
Diode Junction capacitance	$f=1\text{MHz}$ and applied 4V DC reverse Voltage	C_J		120		pF
Storage temperature		T_{STG}	-65		+175	$^\circ\text{C}$

Company reserves the right to improve product design, functions and reliability without notice.

REV: A

Rating and Characteristic Curves (ACDBMT140-HF Thru. ACDBMT1200-HF)

Fig.1 - Typical Forward Current Derating Curve

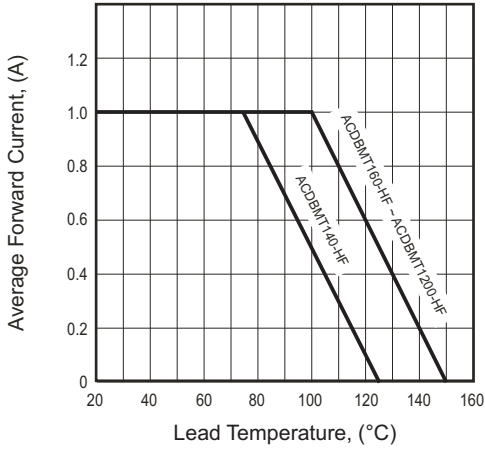

Fig.2 - Typical Forward Characteristics

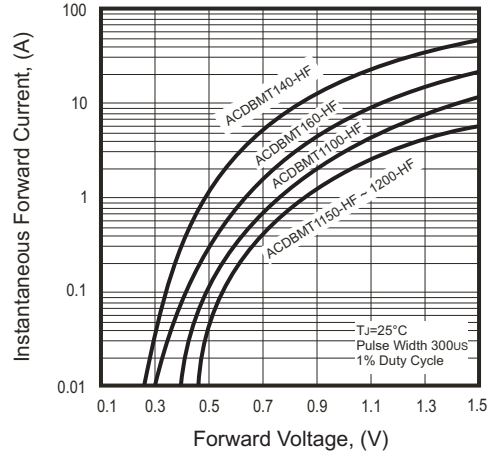

Fig.3 - Maximum Non-repetitive Forward Surge Current

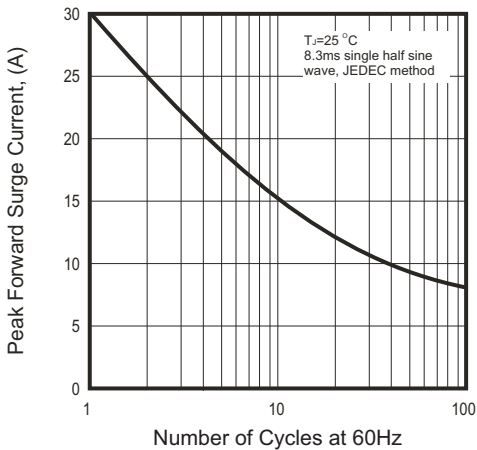

Fig.4 - Typical Junction Capacitance

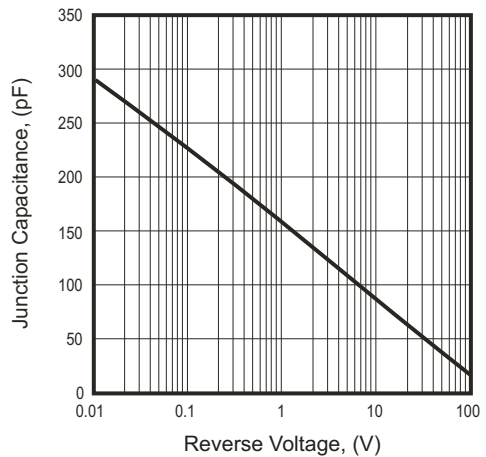
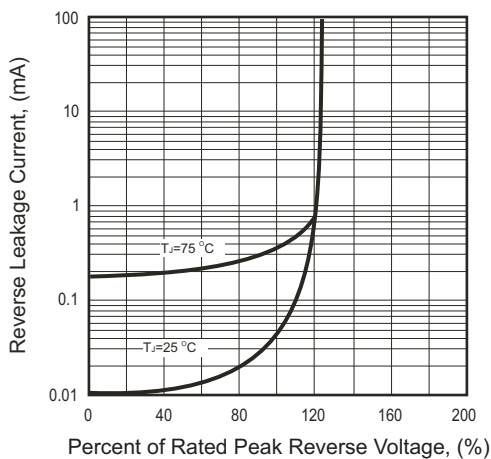
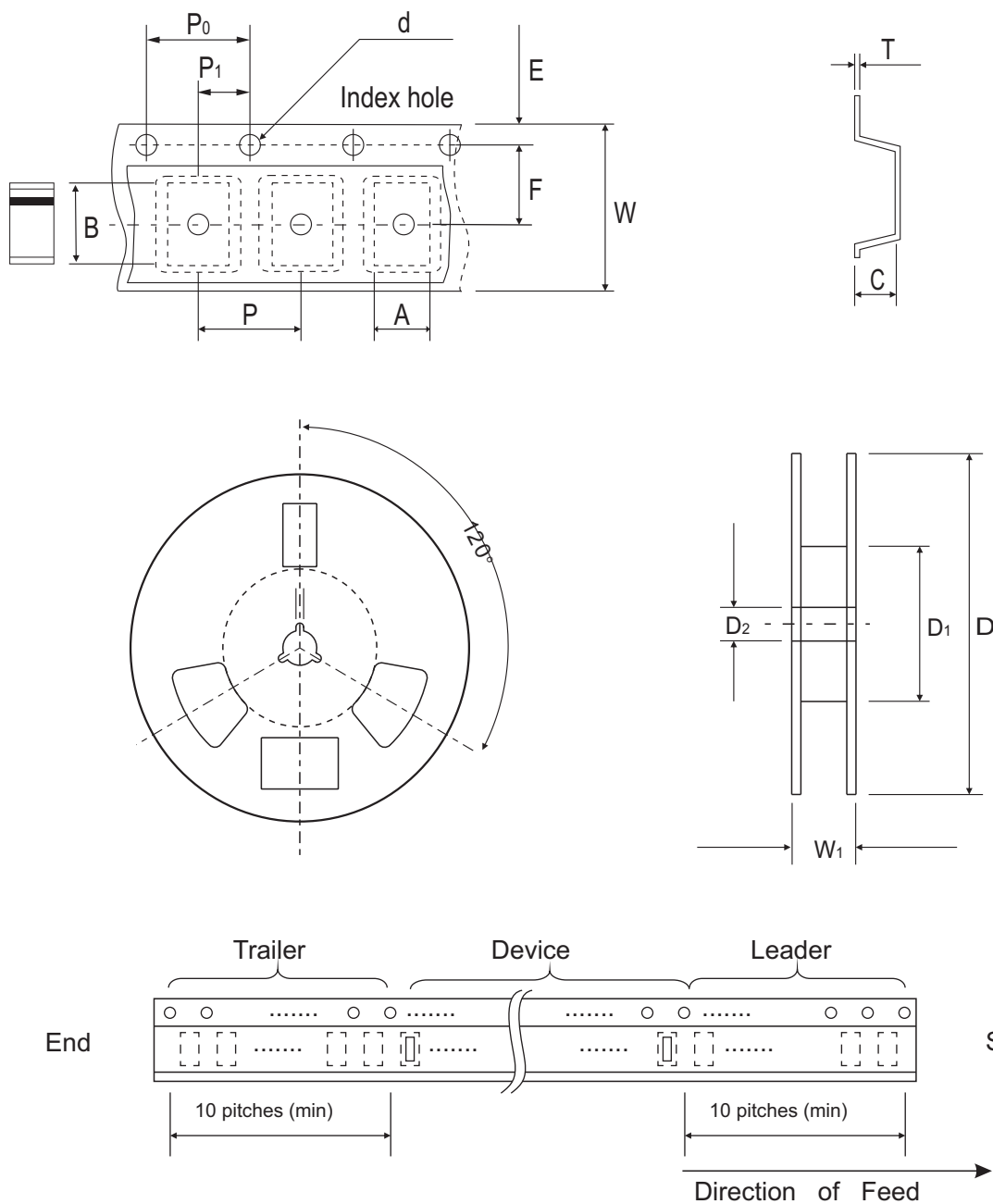

Fig.5 - Typical Reverse Characteristics



Reel Taping Specification



SOD-123H	SYMBOL	A	B	C	d	D	D1	D2
	(mm)	2.00 ± 0.10	3.85 ± 0.10	1.10 ± 0.10	1.50 ± 0.10	178.00 ± 2.00	62.00 (min)	13.00 ± 0.50
	(inch)	0.079 ± 0.004	0.152 ± 0.004	0.043 ± 0.004	0.059 ± 0.004	7.007 ± 0.079	2.441 (min)	0.512 ± 0.020

SOD-123H	SYMBOL	E	F	P	P0	P1	T	W	W1
	(mm)	1.75 ± 0.10	3.50 ± 0.10	4.00 ± 0.10	4.00 ± 0.10	2.00 ± 0.10	0.23 ± 0.10	8.00 ± 0.30	11.40 ± 1.00
	(inch)	0.069 ± 0.004	0.138 ± 0.004	0.157 ± 0.004	0.157 ± 0.004	0.079 ± 0.004	0.009 ± 0.04	0.315 ± 0.012	0.449 ± 0.039

Pinning information

Pin	Simplified outline	Symbol
PIN 1 Cathode PIN 2 Anode		

Marking Code

Part Number	Marking Code
ACDBMT140-HF	14
ACDBMT160-HF	16
ACDBMT1100-HF	10
ACDBMT1150-HF	115
ACDBMT1200-HF	120



xx / xxx = Product type marking code

Suggested PAD Layout

SIZE	SOD-123H	
	(mm)	(inch)
A	3.00	0.118
B	1.30	0.051
C	1.80	0.071
D	4.30	0.169
E	1.70	0.067

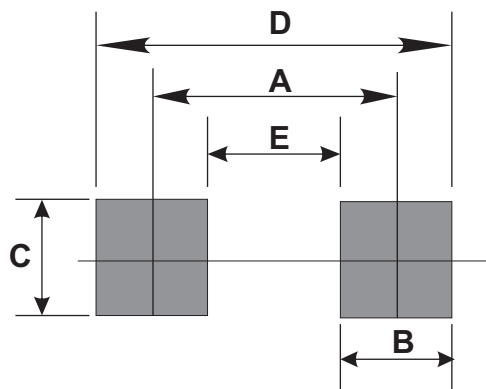

Standard Packaging

Case Type	REEL PACK	
	REEL (pcs)	Reel Size (inch)
SOD-123H	3,000	7

Mouser Electronics

Authorized Distributor

Click to View Pricing, Inventory, Delivery & Lifecycle Information:

[Comchip Technology:](#)

[ACDBMT1100-HF](#) [ACDBMT160-HF](#) [ACDBMT140-HF](#) [ACDBMT1200-HF](#) [ACDBMT1150-HF](#)