



MICROPOWER RAIL-TO-RAIL CMOS OPERATIONAL AMPLIFIER

GENERAL DESCRIPTION

The ALD1701A/ALD1701B/ALD1701/ALD1701G is a monolithic CMOS micropower high slew rate operational amplifier intended for a broad range of analog applications using $\pm 1V$ to $\pm 5V$ dual power supply systems, as well as $+2V$ to $+10V$ battery operated systems. All device characteristics are specified for $+5V$ single supply or $\pm 2.5V$ dual supply systems. Supply current is $250\mu A$ maximum at $5V$ supply voltage. It is manufactured with Advanced Linear Devices' enhanced AC MOS silicon gate CMOS process.

The ALD1701A/ALD1701B/ALD1701/ALD1701G is designed to offer a trade-off of performance parameters providing a wide range of desired specifications. It has been developed specifically for the $+5V$ single supply or $\pm 1V$ to $\pm 5V$ dual supply user and offers the popular industry standard pin configuration of $\mu A741$ and ICL7611 types.

Several important characteristics of the device make application easier to implement at those voltages. First, the operational amplifier can operate with rail to rail input and output voltages. This means the signal input voltage and output voltage can be equal to the positive and negative supply voltages. This feature allows numerous analog serial stages and flexibility in input signal bias levels. Second, the device was designed to accommodate mixed applications where digital and analog circuits may operate off the same power supply or battery. Third, the output stage can typically drive up to $50pF$ capacitive and $10K\Omega$ resistive loads.

These features, combined with extremely low input currents, high open loop voltage gain of $100V/mV$, useful bandwidth of $700KHz$, a slew rate of $0.7V/\mu s$, low power dissipation of $0.5mW$, low offset voltage and temperature drift, make the ALD1701 a versatile, micropower operational amplifier.

The ALD1701A/ALD1701B/ALD1701/ALD1701G, designed and fabricated with silicon gate CMOS technology, offers $1pA$ typical input bias current. On chip offset voltage trimming allows the device to be used without nulling in most applications. Additionally, robust design and rigorous screening make this device especially suitable for operation in temperature-extreme environments and rugged conditions.

FEATURES

- All parameters specified for $+5V$ single supply or $\pm 2.5V$ dual supply systems
- Rail to rail input and output voltage ranges
- No frequency compensation required -- unity gain stable
- Extremely low input bias currents -- $1.0pA$ typical ($30pA$ max.)
- Ideal for high source impedance applications
- Dual power supply $\pm 1.0V$ to $\pm 5.0V$ operation
- Single power supply $+2.0V$ to $+10.0V$ operation
- High voltage gain -- typically $100V/mV$ @ $\pm 2.5V$ ($100dB$)
- Drive as low as $10K\Omega$ load
- Output short circuit protected
- Unity gain bandwidth of $0.7MHz$
- Slew rate of $0.7V/\mu s$
- Low power dissipation
- Suitable for rugged, temperature-extreme environments

APPLICATIONS

- Voltage amplifier
- Voltage follower/buffer
- Charge integrator
- Photodiode amplifier
- Data acquisition systems
- High performance portable instruments
- Signal conditioning circuits
- Sensor and transducer amplifiers
- Low leakage amplifiers
- Active filters
- Sample/Hold amplifier
- Picoammeter
- Current to voltage converter

ORDERING INFORMATION ("L" suffix denotes lead-free (RoHS))

| Operating Temperature Range | | |
|--|---------------------------------|----------------------------------|
| $0^{\circ}C$ to $+70^{\circ}C$ | $0^{\circ}C$ to $+70^{\circ}C$ | $-55^{\circ}C$ to $125^{\circ}C$ |
| 8-Pin Small Outline Package (SOIC) | 8-Pin Plastic Dip Package | 8-Pin CERDIP Package |
| ALD1701ASAL | ALD1701APAL | ALD1701ADA |
| ALD1701BSAL | ALD1701BPAL | ALD1701BDA |
| ALD1701SAL | ALD1701PAL | ALD1701DA |
| ALD1701GSAL | ALD1701GPAL | ALD1701GDA |

* Contact factory for leaded (non-RoHS) or high temperature versions.

PIN CONFIGURATION

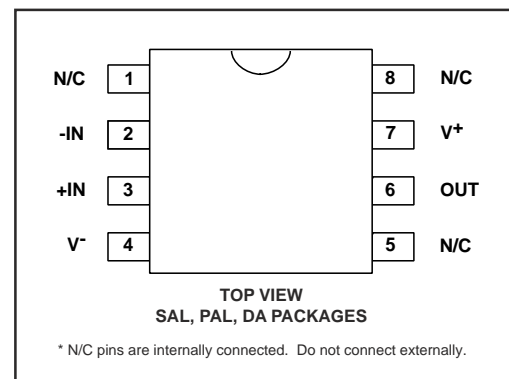

ABSOLUTE MAXIMUM RATINGS

Supply voltage, V₊ _____ 10.6V
 Differential input voltage range _____ -0.3V to V₊+0.3V
 Power dissipation _____ 600 mW
 Operating temperature range SAL, PAL packages _____ 0°C to +70°C
 DA package _____ -55°C to +125°C
 Storage temperature range _____ -65°C to +150°C
 Lead temperature, 10 seconds _____ +260°C

CAUTION: ESD Sensitive Device. Use static control procedures in ESD controlled environment.

OPERATING ELECTRICAL CHARACTERISTICS

T_A = 25°C V_S = ±2.5V unless otherwise specified

| Parameter | Symbol | 1701A | | | 1701B | | | 1701 | | | 1701G | | | Unit | Test Conditions |
|------------------------------|--|-------------------------------|---------------------------------|---------------|--------------|---------------------------------|---------------|--------------|---------------------------------|---------------|--------------|---------------------------------|---------------|-------------------------|---|
| | | Min | Typ | Max | Min | Typ | Max | Min | Typ | Max | Min | Typ | Max | | |
| Supply Voltage | V _S V ₊ | ±1.0 2.0 | | ±5.0 10.0 | ±1.0 2.0 | | ±5.0 10.0 | ±1.0 2.0 | | ±5.0 10.0 | ±1.0 2.0 | | ±5.0 10.0 | V | Dual Supply Single Supply |
| Input Offset Voltage | V _{OS} | | | 0.9 1.7 | | | 2.0 2.8 | | | 4.5 5.3 | | | 10.0 11.0 | mV mV | R _S ≤ 100KΩ 0°C ≤ T _A ≤ +70°C |
| Input Offset Current | I _{OS} | | 1.0 | 25 240 | | 1.0 | 25 240 | | 1.0 | 25 240 | | 1.0 | 30 450 | pA pA | T _A = 25°C 0°C ≤ T _A ≤ +70°C |
| Input Bias Current | I _B | | 1.0 | 30 300 | | 1.0 | 30 300 | | 1.0 | 30 300 | | 1.0 | 50 600 | pA pA | T _A = 25°C 0°C ≤ T _A ≤ +70°C |
| Input Voltage Range | V _{IR} | -0.3 -2.8 | | 5.3 2.8 | -0.3 -2.8 | | 5.3 2.8 | -0.3 -2.8 | | 5.3 2.8 | -0.3 -2.8 | | 5.3 2.8 | V V | V ₊ = +5V V _S = ±2.5V |
| Input Resistance | R _{IN} | | 10 ¹² | | | 10 ¹² | | | 10 ¹² | | | 10 ¹² | | Ω | |
| Input Offset Voltage Drift | TCV _{OS} | | 7 | | | 7 | | | 7 | | | 7 | | μV/°C | R _S ≤ 100KΩ |
| Power Supply Rejection Ratio | PSRR | 70 70 | 80 80 | | 65 65 | 80 80 | | 65 65 | 80 80 | | 60 60 | 80 80 | | dB dB | R _S ≤ 100KΩ 0°C ≤ T _A ≤ +70°C |
| Common Mode Rejection Ratio | CMRR | 70 70 | 83 83 | | 65 65 | 83 83 | | 65 65 | 83 83 | | 60 60 | 83 83 | | dB dB | R _S ≤ 100KΩ 0°C ≤ T _A ≤ +70°C |
| Large Signal Voltage Gain | A _v | 40 20 | 100 1000 | | 32 20 | 100 1000 | | 32 20 | 100 1000 | | 20 10 | 80 1000 | | V/ mV V/ mV V/ mV | R _L = 100KΩ R _L ≥ 1MΩ R _L = 100KΩ 0°C ≤ T _A ≤ +70°C |
| Output Voltage Range | V _O low V _O high V _O low V _O high | 4.99 4.999 2.40 2.48 | 0.001 4.999 -2.48 2.48 | 0.01 -2.40 | 4.99 2.40 | 0.001 4.999 -2.48 2.48 | 0.01 -2.40 | 4.99 2.40 | 0.001 4.999 -2.48 2.48 | 0.01 -2.40 | 4.99 2.40 | 0.001 4.999 -2.48 2.48 | 0.01 -2.40 | V V V V | R _L = 1MΩ V ₊ = +5V 0°C ≤ T _A ≤ +70°C R _L = 100KΩ 0°C ≤ T _A ≤ +70°C |
| Output Short Circuit Current | I _{SC} | | 1 | | | 1 | | | 1 | | | 1 | | mA | |
| Supply Current | I _S | | 120 | 250 | | 120 | 250 | | 120 | 250 | | 120 | 300 | μA | V _{IN} = 0V No Load |
| Power Dissipation | P _D | | | 1.25 | | | 1.25 | | | 1.25 | | | 1.50 | mW | V _S = ±2.5V |

OPERATING ELECTRICAL CHARACTERISTICS (cont'd)

$T_A = 25^\circ\text{C}$ $V_S = \pm 2.5\text{V}$ unless otherwise specified

| Parameter | Symbol | 1701A | | | 1701B | | | 1701 | | | 1701G | | | Unit | Test Conditions |
|-------------------|----------|-------|------|-----|-------|------|-----|------|------|-----|-------|------|-----|------------------|---|
| | | Min | Typ | Max | Min | Typ | Max | Min | Typ | Max | Min | Typ | Max | | |
| Input Capacitance | C_{IN} | | 1 | | | 1 | | | 1 | | | 1 | | pF | |
| Bandwidth | BW | 400 | 700 | | 400 | 700 | | 400 | 700 | | | 700 | | KHz | |
| Slew Rate | S_R | 0.33 | 0.7 | | 0.33 | 0.7 | | 0.33 | 0.7 | | | 0.7 | | V/ μs | $A_V = +1$ $R_L = 100\text{K}\Omega$ |
| Rise time | t_r | | 0.2 | | | 0.2 | | | 0.2 | | | 0.2 | | μs | $R_L = 100\text{K}\Omega$ |
| Overshoot Factor | | | 20 | | | 20 | | | 20 | | | 20 | | % | $R_L = 100\text{K}\Omega$ $C_L = 50\text{pF}$ |
| Settling Time | t_s | | 10.0 | | | 10.0 | | | 10.0 | | | 10.0 | | μs | 0.1% $A_V = -R_L = 100\text{K}\Omega$ $C_L = 50\text{pF}$ |

$T_A = 25^\circ\text{C}$ $V_S = \pm 5.0\text{V}$ unless otherwise specified

| Parameter | Symbol | 1701A | | | 1701B | | | 1701 | | | 1701G | | | Unit | Test Conditions |
|------------------------------|---|-------|---------------|-------|-------|---------------|-------|------|---------------|-------|-------|---------------|-------|------------------|-----------------------------------|
| | | Min | Typ | Max | Min | Typ | Max | Min | Typ | Max | Min | Typ | Max | | |
| Power Supply Rejection Ratio | PSRR | | 83 | | | 83 | | | 83 | | | 83 | | dB | $R_S \leq 100\text{K}\Omega$ |
| Common Mode Rejection Ratio | CMRR | | 83 | | | 83 | | | 83 | | | 83 | | dB | $R_S \leq 100\text{K}\Omega$ |
| Large Signal Voltage Gain | A_V | | 250 | | | 250 | | | 250 | | | 250 | | V/mV | $R_L = 100\text{K}\Omega$ |
| Output Voltage Range | $V_{O\text{ low}}$ $V_{O\text{ high}}$ | 4.90 | -4.98 4.98 | -4.90 | 4.90 | -4.98 4.98 | -4.90 | 4.90 | -4.98 4.98 | -4.90 | 4.90 | -4.98 4.98 | -4.90 | V V | $R_L = 100\text{K}\Omega$ |
| Bandwidth | BW | | 1.0 | | | 1.0 | | | 1.0 | | | 1.0 | | MHz | |
| Slew Rate | S_R | | 1.0 | | | 1.0 | | | 1.0 | | | 1.0 | | V/ μs | $A_V = +1$ $C_L = 50\text{pF}$ |

$V_S = \pm 2.5\text{V}$ $-55^\circ\text{C} \leq T_A \leq +125^\circ\text{C}$ unless otherwise specified

| Parameter | Symbol | 1701BDA | | | 1701DA | | | Unit | Test Conditions |
|------------------------------|---|---------|---------------|-------|--------|---------------|-------|--------|------------------------------|
| | | Min | Typ | Max | Min | Typ | Max | | |
| Input Offset Voltage | V_{OS} | | | 3.0 | | | 6.5 | mV | $R_S \leq 100\text{K}\Omega$ |
| Input Offset Current | I_{OS} | | | 8.0 | | | 8.0 | nA | |
| Input Bias Current | I_B | | | 10.0 | | | 10.0 | nA | |
| Power Supply Rejection Ratio | PSRR | 60 | 75 | | 60 | 75 | | dB | $R_S \leq 100\text{K}\Omega$ |
| Common Mode Rejection Ratio | CMRR | 60 | 83 | | 60 | 83 | | dB | $R_S \leq 100\text{K}\Omega$ |
| Large Signal Voltage Gain | A_V | 15 | 50 | | 15 | 50 | | V/mV | $R_L = 100\text{K}\Omega$ |
| Output Voltage Range | $V_{O\text{ low}}$ $V_{O\text{ high}}$ | 2.35 | -2.47 2.45 | -2.40 | 2.35 | -2.47 2.45 | -2.40 | V V | $R_L = 100\text{K}\Omega$ |

Design & Operating Notes:

1. The ALD1701A/ALD1701B/ALD1701/ALD1701G CMOS operational amplifier uses a 3 gain stage architecture and an improved frequency compensation scheme to achieve large voltage gain, high output driving capability, and better frequency stability. In a conventional CMOS operational amplifier design, compensation is achieved with a pole splitting capacitor together with a nulling resistor. This method is, however, very bias dependent and thus cannot accommodate the large range of supply voltage operation as is required from a stand alone CMOS operational amplifier. The ALD1701A/ALD1701B/ALD1701/ALD1701G is internally compensated for unity gain stability using a novel scheme that does not use a nulling resistor. This scheme produces a clean single pole roll off in the gain characteristics while providing for more than 70 degrees of phase margin at the unity gain frequency.
2. The ALD1701A/ALD1701B/ALD1701/ALD1701G has complementary p-channel and n-channel input differential stages connected in parallel to accomplish rail to rail input common mode voltage range. This means that with the ranges of common mode input voltage close to the power supplies, one of the two differential stages is switched off internally. To maintain compatibility with other operational amplifiers, this switching point has been selected to be about 1.5V below the positive supply voltage. Since offset voltage trimming on the ALD1701A/ALD1701B/ALD1701/ALD1701G is made when the input voltage is symmetrical to the supply voltages, this internal switching does not affect a large variety of applications such as an inverting amplifier or non-inverting amplifier with a gain larger than 2.5 (5V operation), where the common mode voltage does not make excursions above this switching point. The user should however, be aware that this switching does take place if the operational amplifier is connected as a unity gain buffer, and should make provision in his design to allow for input offset voltage variations.
3. The input bias and offset currents are essentially input protection diode reverse bias leakage currents, and are typically less than 1pA

at room temperature. This low input bias current assures that the analog signal from the source will not be distorted by input bias currents. Normally, this extremely high input impedance of greater than $10^{12}\Omega$ would not be a problem as the source impedance would limit the node impedance. However, for applications where source impedance is very high, it may be necessary to limit noise and hum pickup through proper shielding.

4. The output stage consists of class AB complementary output drivers, capable of driving a low resistance load. The output voltage swing is limited by the drain to source on-resistance of the output transistors as determined by the bias circuitry, and the value of the load resistor. When connected in the voltage follower configuration, the oscillation resistant feature, combined with the rail to rail input and output feature, makes an effective analog signal buffer for medium to high source impedance sensors, transducers, and other circuit networks.
5. The ALD1701A/ALD1701B/ALD1701/ALD1701G operational amplifier has been designed to provide full static discharge protection. Internally, the design has been carefully implemented to minimize latch up. However, care must be exercised when handling the device to avoid strong static fields that may degrade a diode junction, causing increased input leakage currents. In using the operational amplifier, the user is advised to power up the circuit before, or simultaneously with any input voltages applied, and to limit input voltages not to exceed 0.3V of the power supply voltage levels.
6. The ALD1701A/ALD1701B/ALD1701/ALD1701G, with its micropower operation, offers numerous benefits in reduced power supply requirements, less noise coupling and current spikes, less thermally induced drift, better overall reliability due to lower self heating, and lower input bias current. It requires practically no warm up time as the chip junction heats up to only 0.1°C above ambient temperature under most operating conditions.

TYPICAL PERFORMANCE CHARACTERISTICS

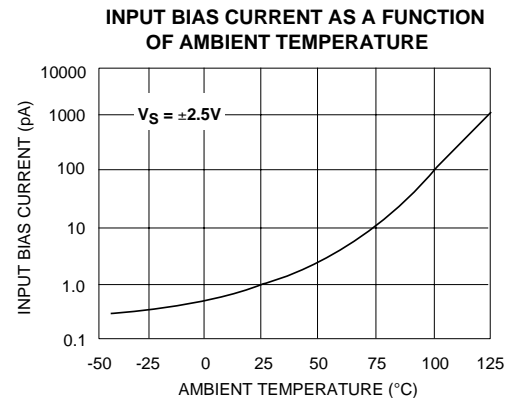
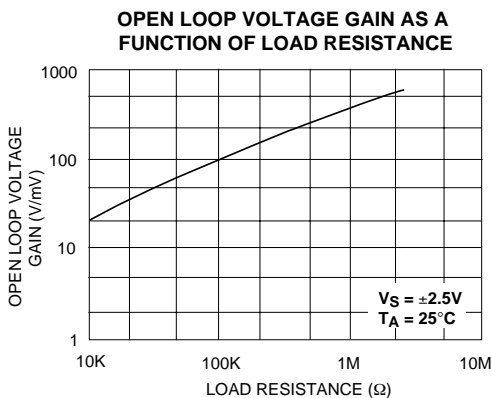
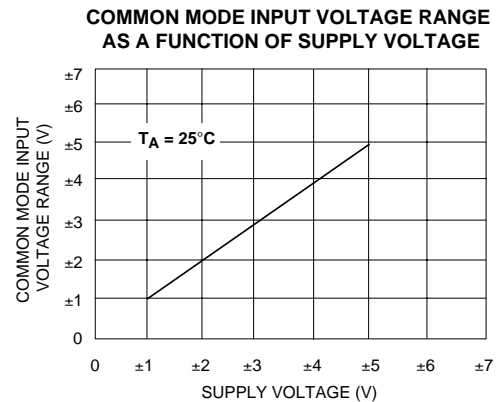
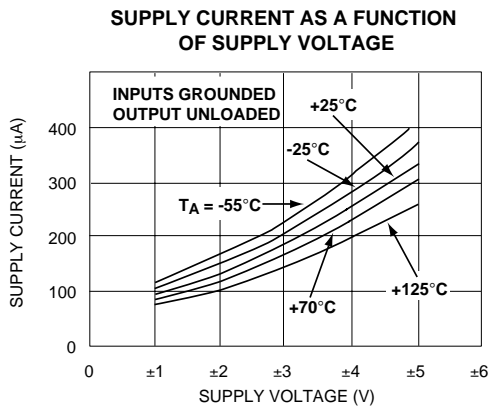

TYPICAL PERFORMANCE CHARACTERISTICS (cont'd)

OPEN LOOP VOLTAGE GAIN AS A FUNCTION OF SUPPLY VOLTAGE AND TEMPERATURE

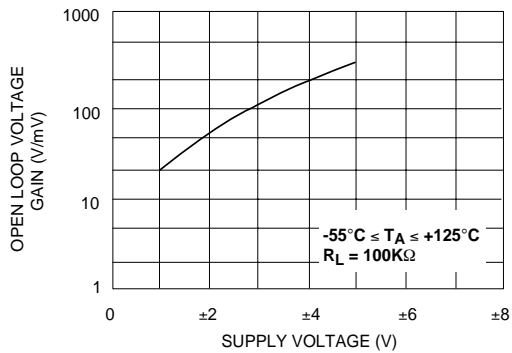

OUTPUT VOLTAGE SWING AS A FUNCTION OF SUPPLY VOLTAGE

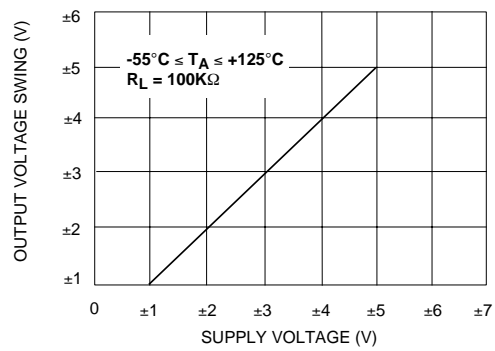

INPUT OFFSET VOLTAGE AS A FUNCTION OF AMBIENT TEMPERATURE REPRESENTATIVE UNITS

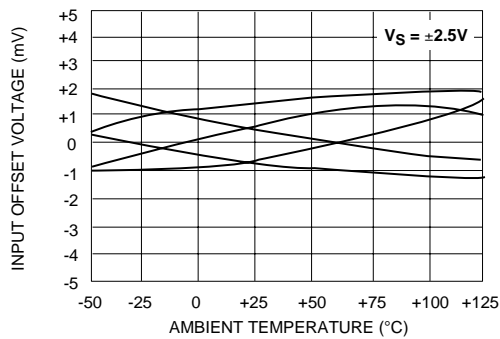

OPEN LOOP VOLTAGE GAIN AS A FUNCTION OF FREQUENCY

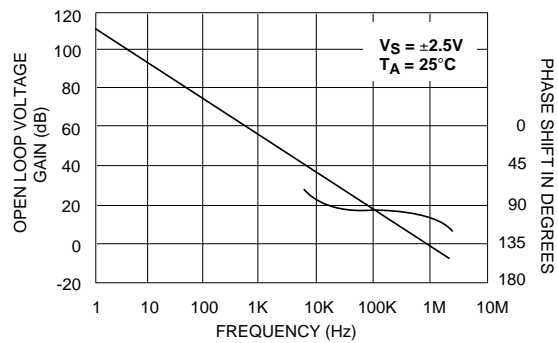

INPUT OFFSET VOLTAGE AS A FUNCTION OF COMMON MODE INPUT VOLTAGE

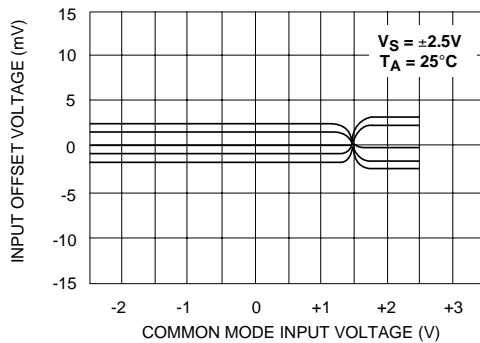

LARGE - SIGNAL TRANSIENT RESPONSE

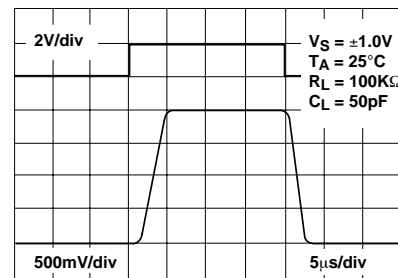

LARGE - SIGNAL TRANSIENT RESPONSE

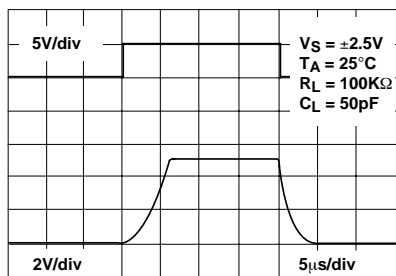

SMALL - SIGNAL TRANSIENT RESPONSE

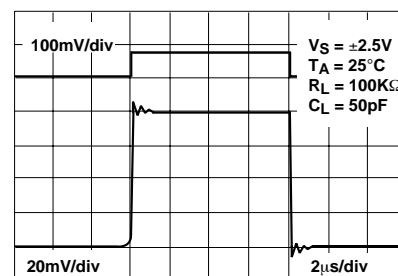

TYPICAL APPLICATIONS

RAIL-TO-RAIL VOLTAGE FOLLOWER/BUFFER

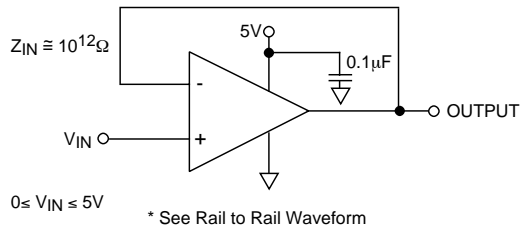

RAIL-TO-RAIL VOLTAGE COMPARATOR

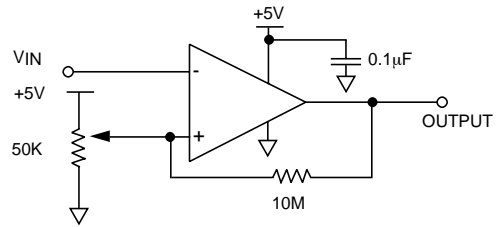

HIGH INPUT IMPEDANCE RAIL-TO-RAIL PRECISION DC SUMMING AMPLIFIER

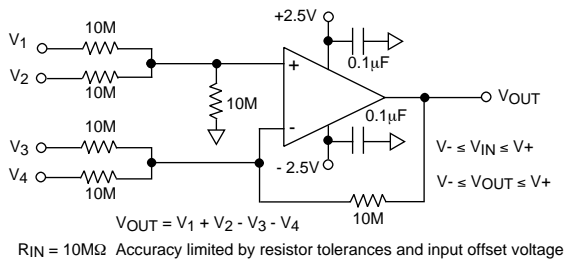

RAIL-TO-RAIL WAVEFORM

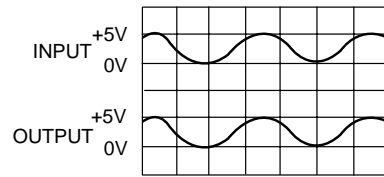

Performance waveforms.
Upper trace is the output of a Wien Bridge Oscillator. Lower trace is the output of Rail-to-rail voltage follower.

WIEN BRIDGE OSCILLATOR (RAIL-TO-RAIL) SINE WAVE GENERATOR

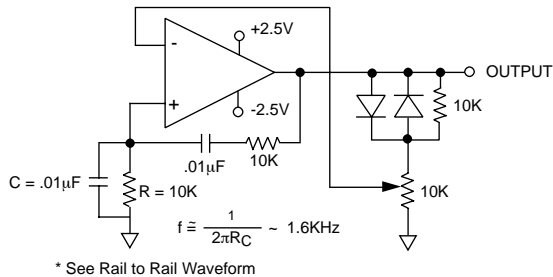
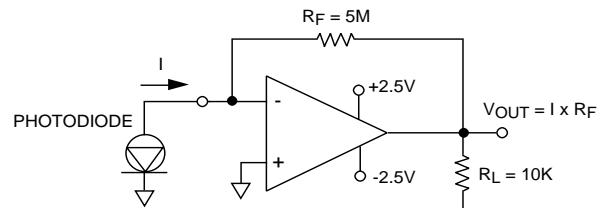
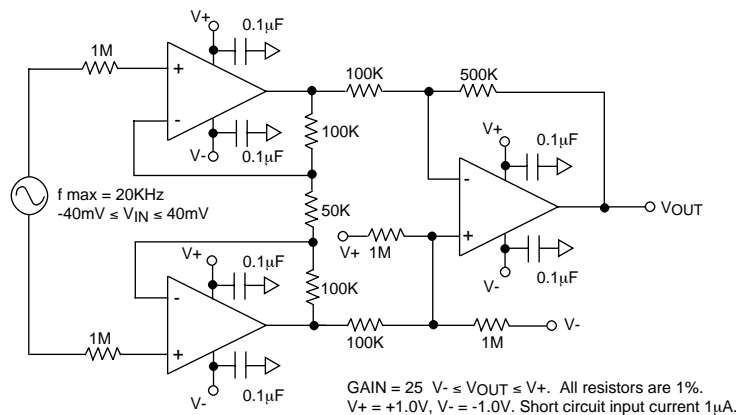

PHOTO DETECTOR CURRENT TO VOLTAGE CONVERTER



LOW VOLTAGE INSTRUMENTATION AMPLIFIER



SOIC-8 PACKAGE DRAWING

8 Pin Plastic SOIC Package

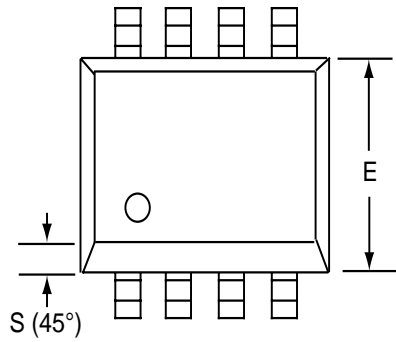

| Dim | Millimeters | | Inches | |
|----------------|-------------|-------|-----------|-------|
| | Min | Max | Min | Max |
| A | 1.35 | 1.75 | 0.053 | 0.069 |
| A ₁ | 0.10 | 0.25 | 0.004 | 0.010 |
| b | 0.35 | 0.45 | 0.014 | 0.018 |
| C | 0.18 | 0.25 | 0.007 | 0.010 |
| D-8 | 4.69 | 5.00 | 0.185 | 0.196 |
| E | 3.50 | 4.05 | 0.140 | 0.160 |
| e | 1.27 BSC | | 0.050 BSC | |
| H | 5.70 | 6.30 | 0.224 | 0.248 |
| L | 0.60 | 0.937 | 0.024 | 0.037 |
| ∅ | 0° | 8° | 0° | 8° |
| S | 0.25 | 0.50 | 0.010 | 0.020 |

PDIP-8 PACKAGE DRAWING

8 Pin Plastic DIP Package

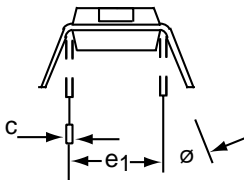

| Dim | Millimeters | | Inches | |
|----------------|-------------|-------|--------|-------|
| | Min | Max | Min | Max |
| A | 3.81 | 5.08 | 0.105 | 0.200 |
| A ₁ | 0.38 | 1.27 | 0.015 | 0.050 |
| A ₂ | 1.27 | 2.03 | 0.050 | 0.080 |
| b | 0.89 | 1.65 | 0.035 | 0.065 |
| b ₁ | 0.38 | 0.51 | 0.015 | 0.020 |
| c | 0.20 | 0.30 | 0.008 | 0.012 |
| D-8 | 9.40 | 11.68 | 0.370 | 0.460 |
| E | 5.59 | 7.11 | 0.220 | 0.280 |
| E ₁ | 7.62 | 8.26 | 0.300 | 0.325 |
| e | 2.29 | 2.79 | 0.090 | 0.110 |
| e ₁ | 7.37 | 7.87 | 0.290 | 0.310 |
| L | 2.79 | 3.81 | 0.110 | 0.150 |
| S-8 | 1.02 | 2.03 | 0.040 | 0.080 |
| ∅ | 0° | 15° | 0° | 15° |

CERDIP-8 PACKAGE DRAWING

8 Pin CERDIP Package

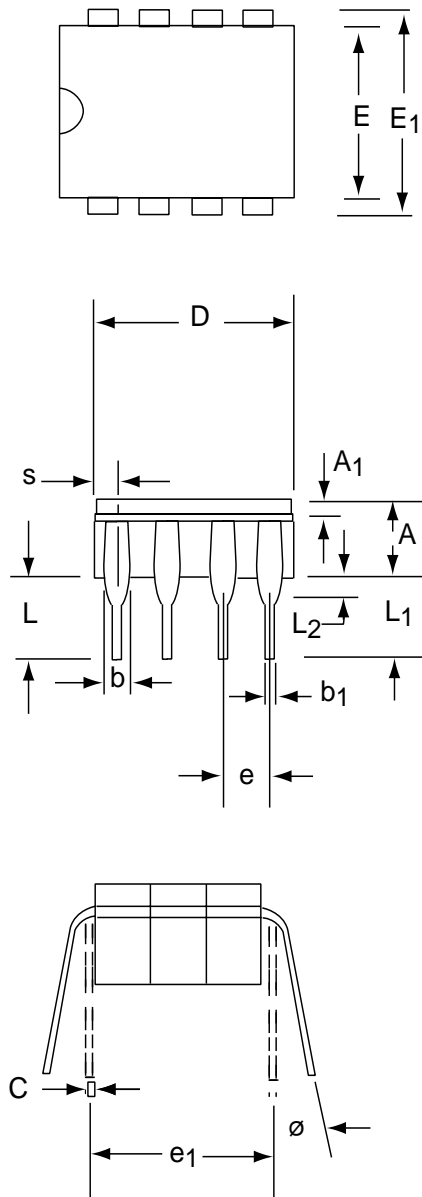

| Dim | Millimeters | | Inches | |
|----------------|-------------|-------|-----------|-------|
| | Min | Max | Min | Max |
| A | 3.55 | 5.08 | 0.140 | 0.200 |
| A ₁ | 1.27 | 2.16 | 0.050 | 0.085 |
| b | 0.97 | 1.65 | 0.038 | 0.065 |
| b ₁ | 0.36 | 0.58 | 0.014 | 0.023 |
| C | 0.20 | 0.38 | 0.008 | 0.015 |
| D-8 | -- | 10.29 | -- | 0.405 |
| E | 5.59 | 7.87 | 0.220 | 0.310 |
| E ₁ | 7.73 | 8.26 | 0.290 | 0.325 |
| e | 2.54 BSC | | 0.100 BSC | |
| e ₁ | 7.62 BSC | | 0.300 BSC | |
| L | 3.81 | 5.08 | 0.150 | 0.200 |
| L ₁ | 3.18 | -- | 0.125 | -- |
| L ₂ | 0.38 | 1.78 | 0.015 | 0.070 |
| S | -- | 2.49 | -- | 0.098 |
| ∅ | 0° | 15° | 0° | 15° |