

Distributed by:

**JAMECO**<sup>®</sup>  
ELECTRONICS

**www.Jameco.com ♦ 1-800-831-4242**

The content and copyrights of the attached  
material are the property of its owner.

Jameco Part Number 1539139

### Features

- Low Turn-on Voltage
- Fast Switching
- PN Junction Guard Ring for Transient and ESD Protection
- Lead Free/RoHS Compliant (Note 3)**
- Qualified to AEC-Q101 Standards for High Reliability**

### Mechanical Data

- Case: SOT-23
- Case Material: Molded Plastic. UL Flammability Classification Rating 94V-0
- Moisture sensitivity: Level 1 per J-STD-020C
- Terminals: Solderable per MIL-STD-202, Method 208
- Lead Free Plating (Matte Tin Finish annealed over Alloy 42 leadframe)
- Polarity: See Diagrams Below
- Marking: See Diagrams Below & Page 3
- Ordering Information: See Page 3
- Weight: 0.008 grams (approximate)

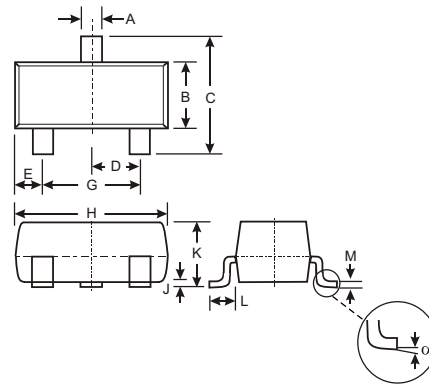

| SOT-23                      |       |       |
|-----------------------------|-------|-------|
| Dim                         | Min   | Max   |
| A                           | 0.37  | 0.51  |
| B                           | 1.20  | 1.40  |
| C                           | 2.30  | 2.50  |
| D                           | 0.89  | 1.03  |
| E                           | 0.45  | 0.60  |
| G                           | 1.78  | 2.05  |
| H                           | 2.80  | 3.00  |
| J                           | 0.013 | 0.10  |
| K                           | 0.903 | 1.10  |
| L                           | 0.45  | 0.61  |
| M                           | 0.085 | 0.180 |
|                             | 0     | 8     |
| <b>All Dimensions in mm</b> |       |       |

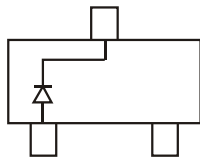

BAS70 Marking: K73, K7C

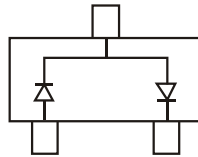

BAS70-04 Marking: K74, K7D

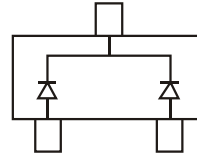

BAS70-05 Marking: K75, K7E

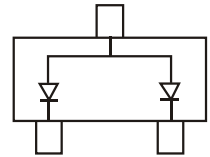

BAS70-06 Marking: K76, K7F

### Maximum Ratings and Electrical Characteristics, Single Diode @ T<sub>A</sub> = 25 °C unless otherwise specified

| Characteristic                                       | Symbol              | Value       | Unit |
|--|---------------------|-------------|------|
| Peak Repetitive Reverse Voltage                      | V <sub>RRM</sub>    | 70          | V    |
| Working Peak Reverse Voltage                         | V <sub>RWM</sub>    |             |      |
| DC Blocking Voltage                                  | V <sub>R</sub>      |             |      |
| RMS Reverse Voltage                                  | V <sub>R(RMS)</sub> | 49          | V    |
| Maximum Forward Continuous Current (Note 1)          | I <sub>FM</sub>     | 70          | mA   |
| Non-Repetitive Peak Forward Surge Current @ t = 1.0s | I <sub>FSM</sub>    | 100         | mA   |
| Power Dissipation (Note 1)                           | P <sub>d</sub>      | 200         | mW   |
| Thermal Resistance Junction to Ambient Air (Note 1)  | R <sub>JA</sub>     | 625         | °C/W |
| Operating Junction Temperature Range                 | T <sub>j</sub>      | -55 to +125 | °C   |
| Storage Temperature Range                            | T <sub>STG</sub>    | -65 to +150 | °C   |

### Electrical Ratings @ T<sub>A</sub> = 25 °C unless otherwise specified

| Characteristic                     | Symbol             | Min | Max         | Unit | Test Condition  |
|------------------------------------|--------------------|-----|-------------|------|---|
| Reverse Breakdown Voltage (Note 2) | V <sub>(BR)R</sub> | 70  | —           | V    | I <sub>R</sub> = 10   |
| Forward Voltage                    | V <sub>F</sub>     | —   | 410<br>1000 | mV   | t <sub>p</sub> < 300µs, I <sub>F</sub> = 1.0mA<br>t <sub>p</sub> < 300µs, I <sub>F</sub> = 15mA |
| Reverse Current (Note 2)           | I <sub>R</sub>     | —   | 100         | nA   | t <sub>p</sub> < 300µs, V <sub>R</sub> = 50V  |
| Total Capacitance                  | C <sub>T</sub>     | —   | 2.0         | pF   | V <sub>R</sub> = 0V, f = 1.0MHz   |
| Reverse Recovery Time              | t <sub>rr</sub>    | —   | 5.0         | ns   | I <sub>F</sub> = I <sub>R</sub> = 10mA to I <sub>R</sub> = 1.0mA, R <sub>L</sub> = 100          |

- Notes:
- Part mounted on FR-4 board with recommended pad layout, which can be found on our website at <http://www.diodes.com/datasheets/ap02001.pdf>.
  - Short duration pulse test used to minimize self-heating effect.
  - No purposefully added lead.

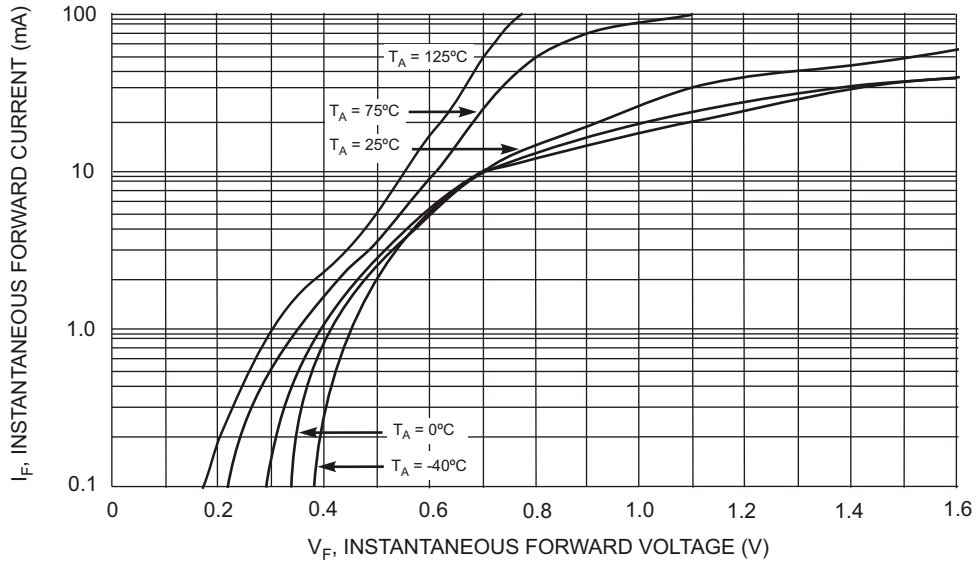

Fig. 1 Typical Forward Characteristics

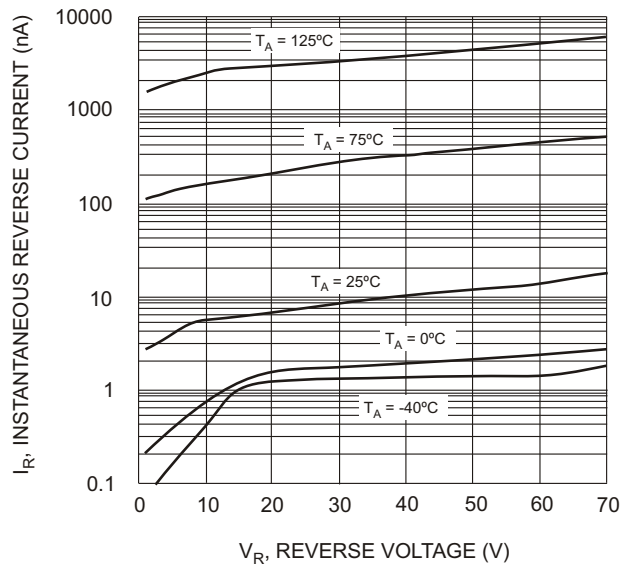

Fig. 2 Typical Reverse Characteristics

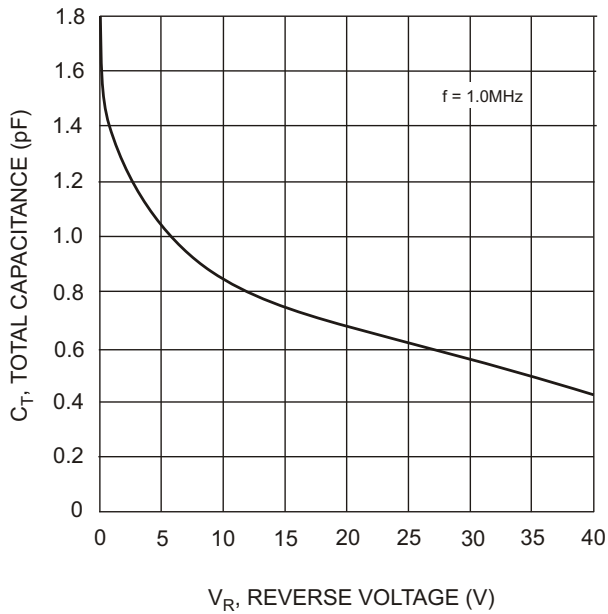

Fig. 3 Typical Total Capacitance vs. Reverse Voltage

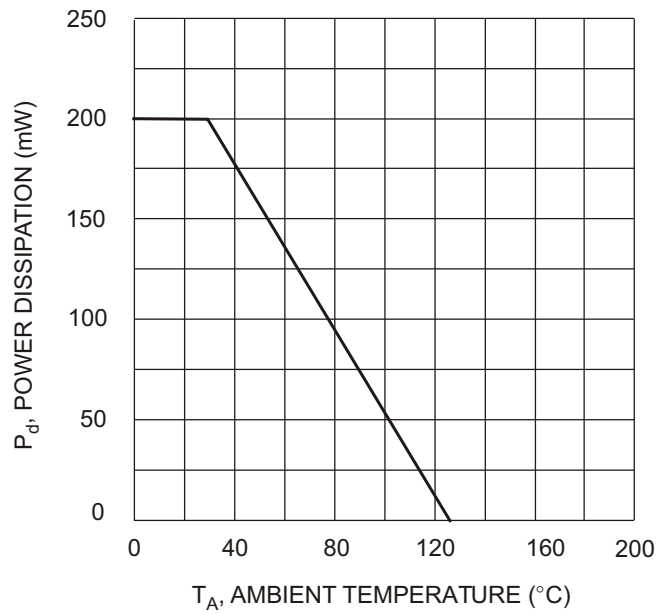

Fig. 4 Power Derating Curve, Total Package

**Ordering Information** (Note 4)

| Device        | Packaging | Shipping         |
|---------------|-----------|------------------|
| BAS70-7-F     | SOT-23    | 3000/Tape & Reel |
| BAS70-04-7-F  | SOT-23    | 3000/Tape & Reel |
| BAS70-05--7-F | SOT-23    | 3000/Tape & Reel |
| BAS70-06-7-F  | SOT-23    | 3000/Tape & Reel |

Notes: 4. For Packaging Details, go to our website at <http://www.diodes.com/datasheets/ap02007.pdf>.

**Marking Information**

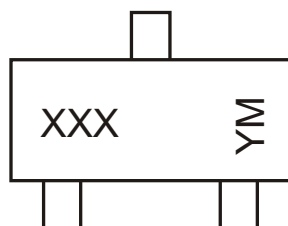

XXX = Product Type Marking Code (See Page 1)  
 YM = Date Code Marking  
 Y = Year ex: T = 2006  
 M = Month ex: 9 = September

Date Code Key

| Year | 2001 | 2002 | 2003 | 2004 | 2005 | 2006 | 2007 | 2008 | 2009 | 2010 | 2011 | 2012 |
|------|------|------|------|------|------|------|------|------|------|------|------|------|
| Code | M    | N    | P    | R    | S    | T    | U    | V    | W    | X    | Y    | Z    |

| Month | Jan | Feb | Mar | Apr | May | Jun | Jul | Aug | Sep | Oct | Nov | Dec |
|-------|-----|-----|-----|-----|-----|-----|-----|-----|-----|-----|-----|-----|
| Code  | 1   | 2   | 3   | 4   | 5   | 6   | 7   | 8   | 9   | O   | N   | D   |

**IMPORTANT NOTICE**

Diodes Incorporated and its subsidiaries reserve the right to make modifications, enhancements, improvements, corrections or other changes without further notice to any product herein. Diodes Incorporated does not assume any liability arising out of the application or use of any product described herein; neither does it convey any license under its patent rights, nor the rights of others. The user of products in such applications shall assume all risks of such use and will agree to hold Diodes Incorporated and all the companies whose products are represented on our website, harmless against all damages.

**LIFE SUPPORT**

Diodes Incorporated products are not authorized for use as critical components in life support devices or systems without the expressed written approval of the President of Diodes Incorporated.