

Bussmann CC06H Series

High I²t Chip™ 0603 size fuses

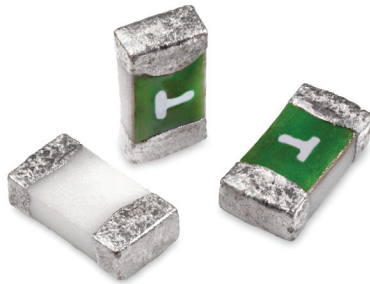

Product description:

- Halogen free, lead free and RoHS compliant
- High inrush withstand capability
- Fast-acting performance
- Ampacity alpha mark on fuse for easy identification
- Standard termination design for easy solderability
- Compatible with standard lead-free solder reflow and wave soldering processes
- Excellent environmental integrity

Applications

For secondary protection in space constrained applications such as:

- LCD Backlight inverters
- Digital cameras
- DVD Players
- Bluetooth headsets
- Battery packs

Agency information

- cURus Recognized Guide and Card JDXY2/JDYX8, File E19180

Packaging

- TR - Packaging code suffix for tape-and-reel (8mm wide tape on 178mm diameter reel - specification EIA 481-1)
- Quantity = 5000 fuses



Electrical characteristics

Amp Rating	% of Amp Rating	Opening Time
1-8A	100	4 Hours
1-7A	200	1-60 Seconds
1-8A	250	5 Seconds Max

Specifications

Catalog Number	Amp Rating ⁵	Voltage Rating (Vdc)	Interrupting Rating ^{1,4} (amps)	Typical Cold Resistance ² (Ω)	Typical Pre-Arcing ³ (I ² t)	Typical Voltage Drop (mV)	Typical Power Dissipation (W)	Alpha Marking	Agency Information (cURus)
CC06H1A	1	32	50	0.25	0.02	310	0.32	B	x
CC06H1.5A	1.5	32	50	0.13	0.07	250	0.38	H	x
CC06H2A	2	32	50	0.068	0.14	170	0.38	K	x
CC06H2.5A	2.5	32	50	0.05	0.25	155	0.38	L	x
CC06H3A	3	32	50	0.035	0.30	130	0.38	O	x
CC06H3.5A	3.5	32	50	0.023	0.50	100	0.35	R	x
CC06H4A	4	32	50	0.02	0.8	110	0.45	S	x
CC06H5A	5	32	50	0.013	1.6	95	0.48	T	x
CC06H6A	6	32	50	0.0076	2.6	80	0.48	V	x
CC06H7A	7	32	50	0.0056	3.3	80	0.56	X	x
CC06H8A	8	32/24	50/80	0.0040	4.5	75	0.60	Z	x

- DC Interrupting Rating (measured at rated voltage, time constant of less than 50 microseconds, battery source).
- DC Cold Resistance are measured at <10% of rated current in ambient temperature of 20°C -
FOR REFERENCE ONLY - CONTROLLED VALUES HELD BY PLANT AND SUBJECT TO CHANGE WITHOUT NOTICE.
- Typical Pre-arcing I²t are measured at rated DC voltage, 10I_n current (not to exceed interrupting rating).
- The insulation resistance after breaking capacity test is higher than 0.1MΩ when measured by 2X rated voltage.
- Device designed to carry rated current for 4 hours minimum. An operating current 80% or less of rated current is recommended, with further design derating required at elevated ambient temperature. See Temperature Derating Curve on next page.

Time-current curves — average melt

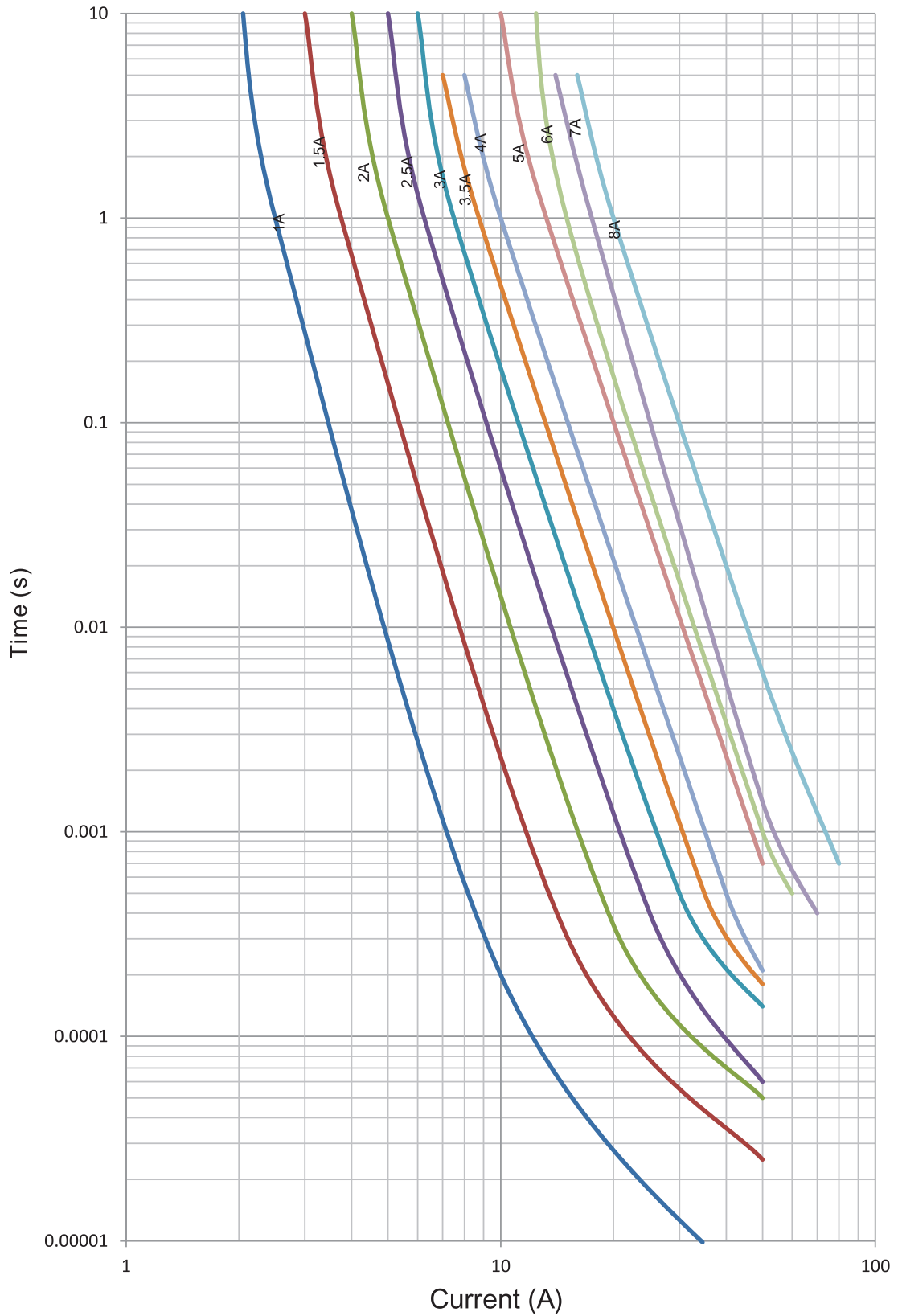

I²t vs. time curves

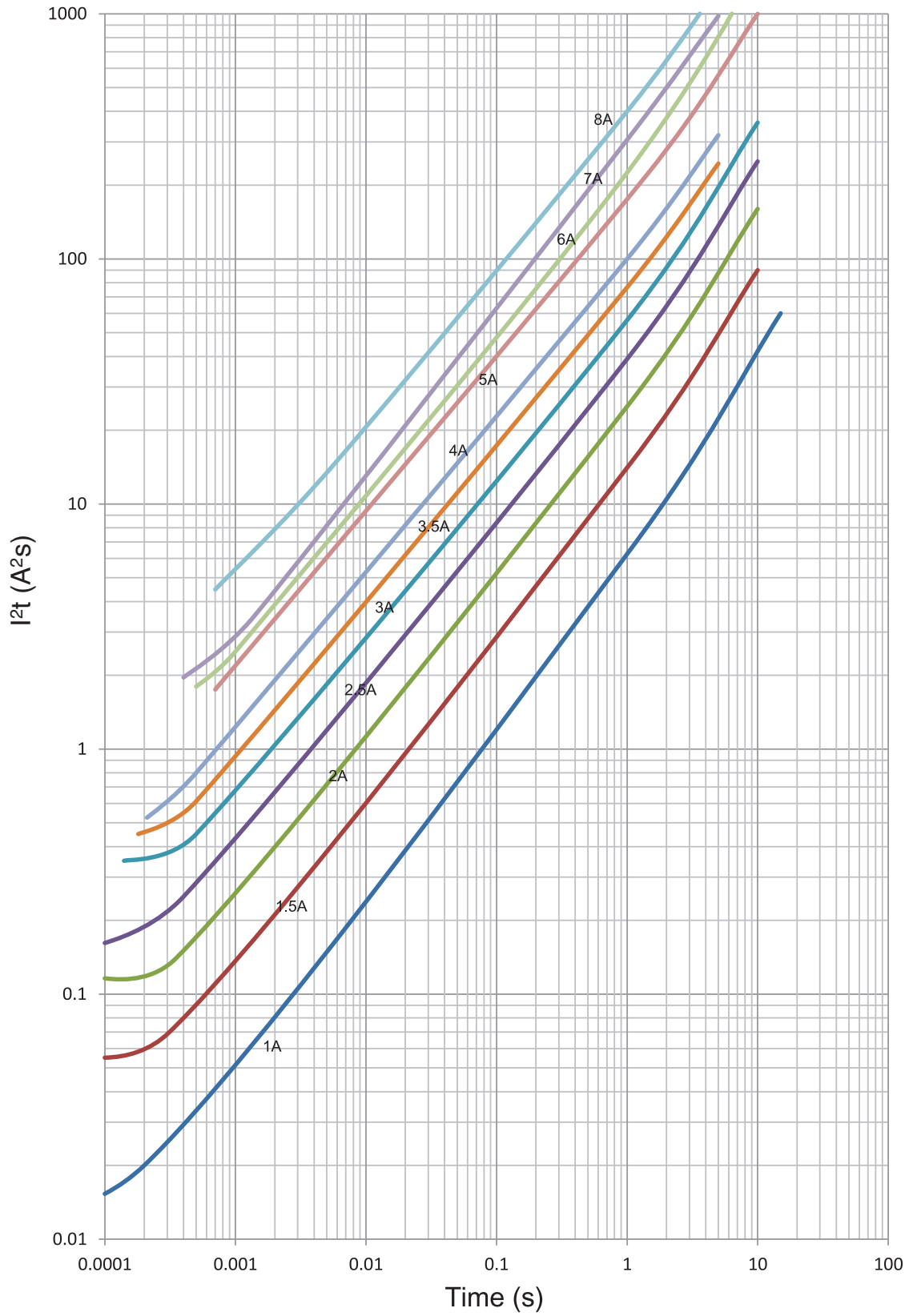

I²t vs. current curves

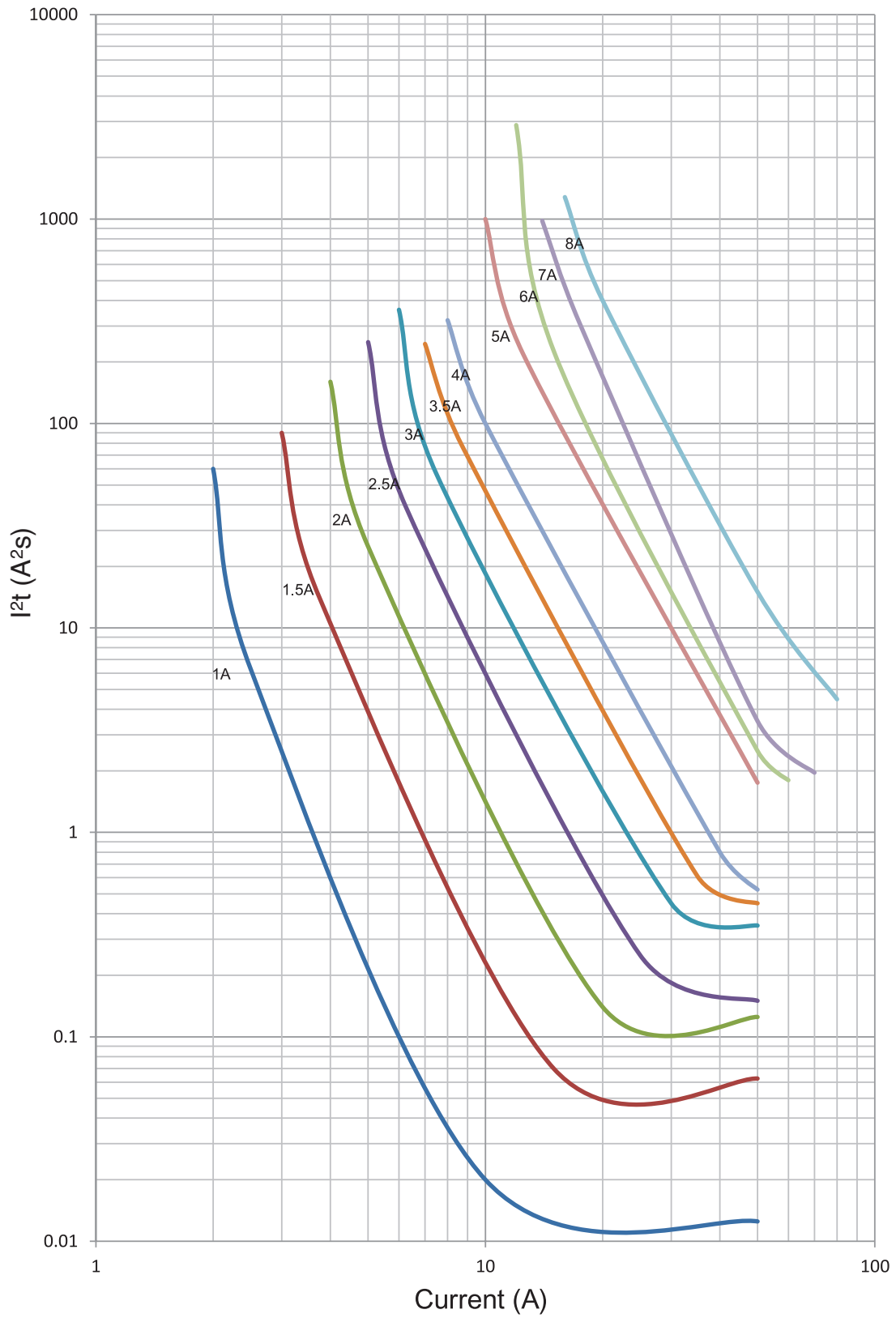

Temperature derating curve

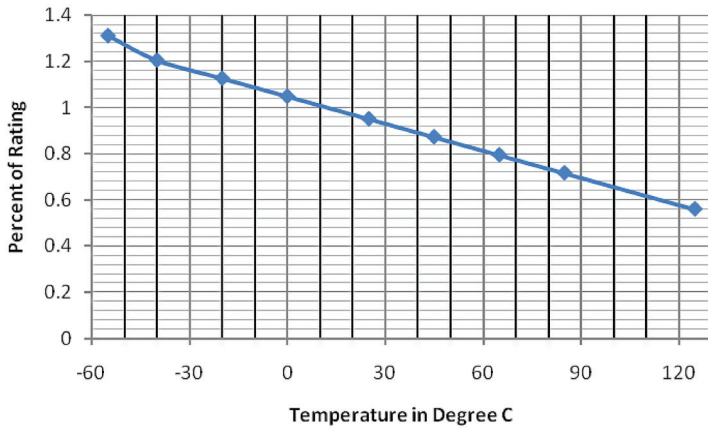

Pad layout

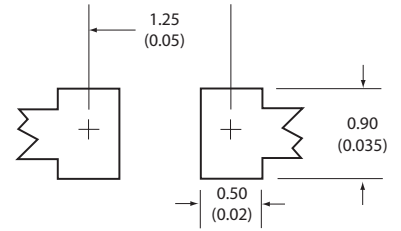

Dimensions - mm (in)

Drawing not to scale.

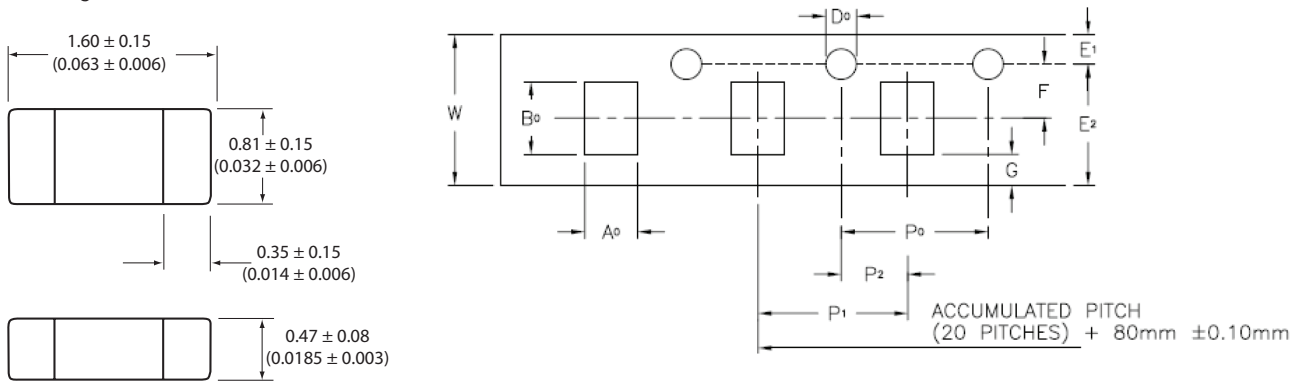

A ₀	B ₀	D ₀	E ₁	E ₂	F	G	P ₀	P ₁	P ₂	T	W
0.95 ±0.05	1.80 ±0.05	1.50 +0.10, -0.0	1.75 ±0.10	6.25 ±0.30	3.50 ±0.05	0.75 min.	4.00 ±0.10	4.00 ±0.10	2.00 ±0.05	0.060 ±0.05	8.00 ±0.20

Product characteristics

Operating temperature	-40°C to 85°C , with proper derating factor applied
Storage temperature	-40°C to 85°C
Load humidity	MIL-STD-202G, Method 103B (1000 hr @ 85°C / 85% RH & 10% rated current)
Moisture resistance	MIL-STD-202, Method 106E (50 cycles)
Thermal shock	MIL-STD-202, Method 107D (-65°C to +125°C, 100 cycles)
Vibration test	MIL-STD-202, Method 204D, Test Condition D (10-2,000Hz)
Mechanical shock resistance	MIL-STD-202, Method 213B (3000G / 0.3ms)
Salt spray resistance	MIL-STD-202, Method 101, Test Condition B (48 hr exposure)
Insulation resistance	The insulation resistance after breaking capacity test is higher than 0.1MW when measured by 2X rated voltage
Solderability	J-STD-002C Method B1 (Dip and Look Test), Method G1 (Wetting Balance Test), Method D (Resistance to Dissolution / Dewetting of Metalization)
Resistance to soldering heat	MIL-STD-202, Method 210F (Solder dip - 260°C, 60 seconds / Solder Iron - 350°C, 3-5 seconds)
High temperature life test	MIL-STD-202G, Method 108A (1000 Hours @ 70°C & 60% rated current)
Resistance to solvents	MIL-STD-202, Method 215K

Solder reflow profile

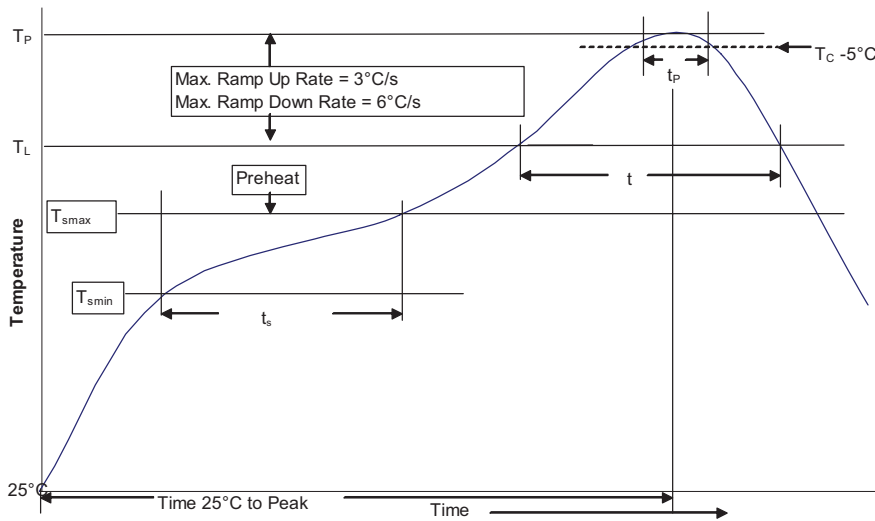

Table 1 - Standard SnPb Solder (T_C)

Package Thickness	Volume <350 mm ³	Volume ≥350 mm ³
<2.5mm	235°C	220°C
≥2.5mm	220°C	220°C

Table 2 - Lead (Pb) Free Solder (T_C)

Package Thickness	Volume <350 mm ³	Volume 350 - 2000 mm ³	Volume >2000 mm ³
<1.6mm	260°C	260°C	260°C
1.6 - 2.5mm	260°C	250°C	245°C
>2.5mm	250°C	245°C	245°C

Reference JDEC J-STD-020D

Profile Feature	Standard SnPb Solder	Lead (Pb) Free Solder
Preheat and Soak	100°C	150°C
• Temperature min. (T_{smin})	150°C	200°C
• Temperature max. (T_{smax})	60-120 Seconds	60-120 Seconds
• Time (T_{smin} to T_{smax}) (t_s)	3°C/ Second Max.	3°C/ Second Max.
Average ramp up rate T_{smax} to T_P	183°C	217°C
Liquidous temperature (T_L)	60-150 Seconds	60-150 Seconds
Time at liquidous (t_L)	Table 1	Table 2
Peak package body temperature (T_P)*	20 Seconds**	30 Seconds**
Time (t_p)** within 5 °C of the specified classification temperature (T_C)	6°C/ Second Max.	6°C/ Second Max.
Average ramp-down rate (T_P to T_{smax})	6 Minutes Max.	8 Minutes Max.
Time 25°C to Peak Temperature		

* Tolerance for peak profile temperature (T_P) is defined as a supplier minimum and a user maximum.

** Tolerance for time at peak profile temperature (t_p) is defined as a supplier minimum and a user maximum.

North America

Eaton's Electrical Group
Electronics Division
1225 Broken Sound Parkway NW
Suite F
Boca Raton, FL 33487-3533
Tel: 1-561-998-4100
Fax: 1-561-241-6640
Toll Free: 1-888-414-2645

Eaton's Electrical Group
Electronics Division
P.O. Box 14460
St. Louis, MO 63178-4460
Tel: 1-636-394-2877
Fax: 1-636-527-1607

Europe

Eaton's Electrical Group
Electronics Division
Burton-on-the-Wolds
Leicestershire, LE 12 5th UK
Phone: +44 (0) 1509 882 600
Fax: +44 (0) 1509 882 786

Eaton's Electrical Group
Electronics Division
Avda Santa Eulalia, 290
Terrassa, Barcelona 08223 Spain
Phone: +34-93-736-2813
Fax: +34-93-783-5055

Asia Pacific

Eaton's Electrical Group
Electronics Division
No.2, #06-01
Serangoon North Avenue 5
Singapore 554911
Tel: +65 6645 9888
Fax: +65 6728 3155

The only controlled copy of this Data Sheet is the electronic read-only version located on the Bussmann Network Drive. All other copies of this document are by definition uncontrolled. This bulletin is intended to clearly present comprehensive product data and provide technical information that will help the end user with design applications. Bussmann reserves the right, without notice, to change design or construction of any products and to discontinue or limit distribution of any products. Bussmann also reserves the right to change or update, without notice, any technical information contained in this bulletin. Once a product has been selected, it should be tested by the user in all possible applications.

Life Support Policy: Bussmann does not authorize the use of any of its products for use in life support devices or systems without the express written approval of an officer of the Company. Life support systems are devices which support or sustain life, and whose failure to perform, when properly used in accordance with instructions for use provided in the labeling, can be reasonably expected to result in significant injury to the user.

**Eaton's Electrical Group
Electronics Division**
114 Old State Road
Ellisville, MO 63021
United States
www.eaton.com/elx



Powering Business Worldwide

© 2014 Eaton
All Rights Reserved
Publication No. 4346 — BU-SB14476
June 2014

Eaton is a registered trademark.

All other trademarks are property of their respective owners.

www.eaton.com/elx

Mouser Electronics

Authorized Distributor

Click to View Pricing, Inventory, Delivery & Lifecycle Information:

[Eaton:](#)

[CC06H1-5A-TR](#) [CC06H1A-TR](#) [CC06H2-5A-TR](#) [CC06H2A-TR](#) [CC06H3-5A-TR](#) [CC06H3A-TR](#) [CC06H4A-TR](#)
[CC06H5A-TR](#) [CC06H1.5A-TR](#) [CC06H2.5A-TR](#) [CC06H3.5A-TR](#) [UP2-150-R](#) [UP2-6R8-R](#)