

## CZRER2V4B-HF Thru CZRER39VB-HF

Voltage 2.4 to 39 Volts

Power 150 mWatts

RoHS Device

Halogen free

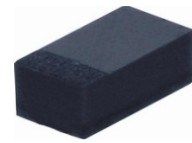

### Features

- 150mW Power Dissipation.
- High Voltages from 2.4 ~ 39 V.
- Designed for mounting on small surface.
- Extremely thin/leadless package.
- Constant voltage control.
- Pb free product.

### Mechanical data

- Case: 0503/SOD-723F Standard package  
Molded plastic.
- Terminals: Gold plated, solderable per MIL-STD-750,method 2026.
- Polarity: Indicated by cathode band.
- Weight: 0.002 gram(approx.).

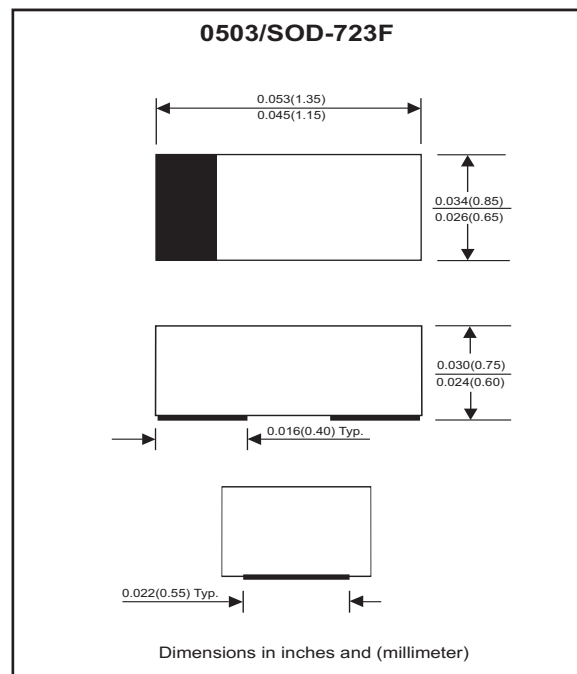

### Maximum Rating AND Electrical Characteristics

Parameter	Symbol	Value	Unit
Maximum Forward Voltage Drop at $I_F = 10 \text{ mA}$	$V_F$	0.9	V
Maximum Power Dissipation at $25 \text{ C}^\circ$	$P_D$	150	mW
Forward current , surge peak 8.3 ms single half sine-wave superimposed on rate load( JEDEC method )	$I_{FSM}$	2.0	A
Peak ESD voltage capability (IEC 61000-4-2)	$V_{PV}$	8	kV
Operating Junction and Storage Temperature Range	$T_J$	-55 to +125	$^\circ\text{C}$

## Electrical Characteristics(Ta = 25C) °

Part Number	Marking Code	Zener Voltage			Operating resistance		Rising operating Resistance		Reverse current	
		Vz(V)			ZZT(Ohm)		ZZK(Ohm)		IR(uA)	
		Min	Max	Iz(mA)	Max	Iz(mA)	Max	Iz(mA)	Max	VR(V)
CZRER2V4B-HF	U2	2.34	2.46	5	100	5	1800	0.25	100	1
CZRER2V7B-HF	U3	2.63	2.77	5	100	5	1900	0.25	75	1
CZRER3V0B-HF	U4	2.93	3.08	5	95	5	2000	0.25	50	1
CZRER3V3B-HF	U5	3.22	3.38	5	95	5	2200	0.25	25	1
CZRER3V6B-HF	U6	3.51	3.69	5	90	5	2300	0.25	15	1
CZRER3V9B-HF	U7	3.80	4.00	5	90	5	2400	0.25	10	1
CZRER4V3B-HF	U8	4.19	4.41	5	88	5	2500	0.25	5	1
CZRER4V7B-HF	U9	4.58	4.82	5	70	5	2200	0.25	3	1.5
CZRER5V1B-HF	UA	4.97	5.23	5	50	5	2050	0.25	2	2
CZRER5V6B-HF	UB	5.46	5.74	5	25	5	1800	0.25	2	3
CZRER6V2B-HF	UC	6.05	6.36	5	10	5	1300	0.25	1	4
CZRER6V8B-HF	UE	6.63	6.97	5	8	5	750	0.25	1	5.2
CZRER7V5B-HF	UF	7.31	7.69	5	7	5	600	0.25	0.5	6
CZRER8V2B-HF	UG	8.00	8.41	5	7	5	600	0.25	0.5	6.5
CZRER9V1B-HF	UH	8.87	9.33	5	10	5	600	0.25	0.1	7
CZRER10VB-HF	UJ	9.75	10.25	5	15	5	600	0.25	0.1	8
CZRER11VB-HF	UK	10.73	11.27	5	18	5	600	0.25	0.1	8.4
CZRER12VB-HF	UM	11.70	12.30	5	22	5	600	0.25	0.1	9.1
CZRER13VB-HF	UN	12.68	13.32	5	25	5	600	0.25	0.1	9.9
CZRER15VB-HF	UP	14.63	15.37	5	32	5	600	0.25	0.1	11
CZRER16VB-HF	UQ	15.60	16.40	5	36	5	600	0.25	0.1	12
CZRER18VB-HF	UR	17.55	18.45	5	42	5	600	0.25	0.1	14
CZRER20VB-HF	US	19.50	20.50	5	48	5	600	0.25	0.1	15
CZRER22VB-HF	UT	21.45	22.55	5	55	5	600	0.25	0.1	17
CZRER24VB-HF	UU	23.40	24.60	5	62	5	600	0.25	0.1	18
CZRER27VB-HF	UV	26.33	27.67	5	70	5	600	0.25	0.1	21
CZRER30VB-HF	UW	29.25	30.75	5	78	5	600	0.25	0.1	23
CZRER33VB-HF	UX	32.18	33.82	5	88	5	700	0.25	0.1	25
CZRER36VB-HF	UY	35.10	36.90	5	95	5	700	0.25	0.1	27
CZRER39VB-HF	UZ	38.03	39.97	5	130	5	800	0.25	0.1	30

## RATING AND CHARACTERISTIC CURVES (CZRER2V4B-HF Thru CZRER39VB-HF)

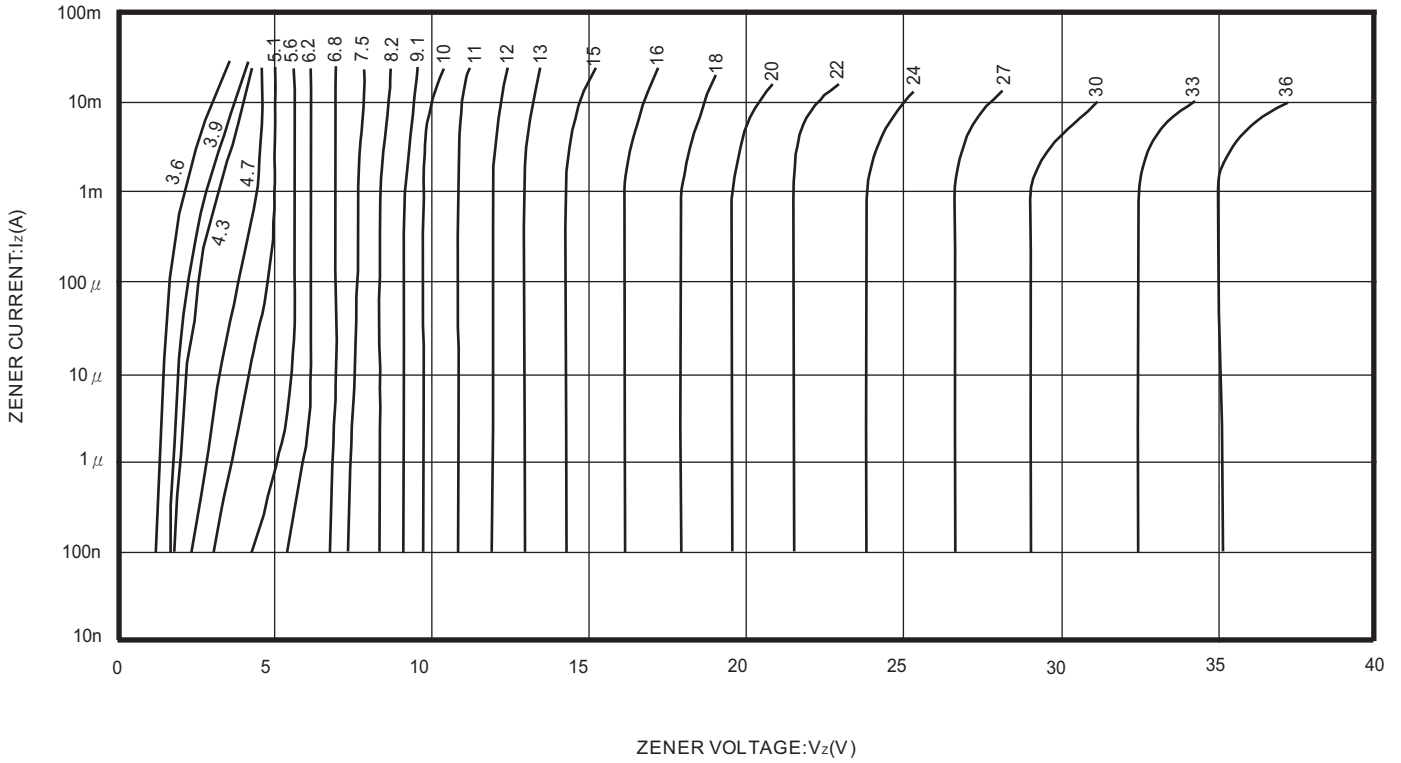

ZENER VOLTAGE:  $V_z$ (V)  
Fig. 1 Zener voltage characteristics

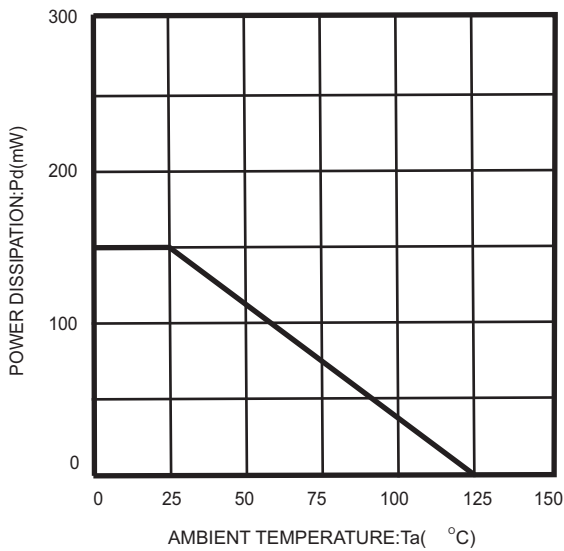

Fig. 2 Derating curve

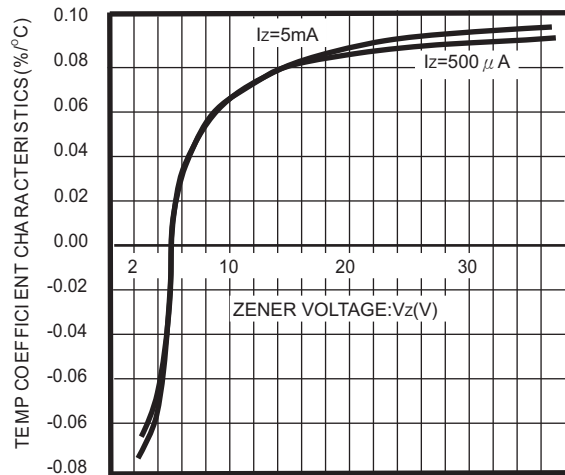
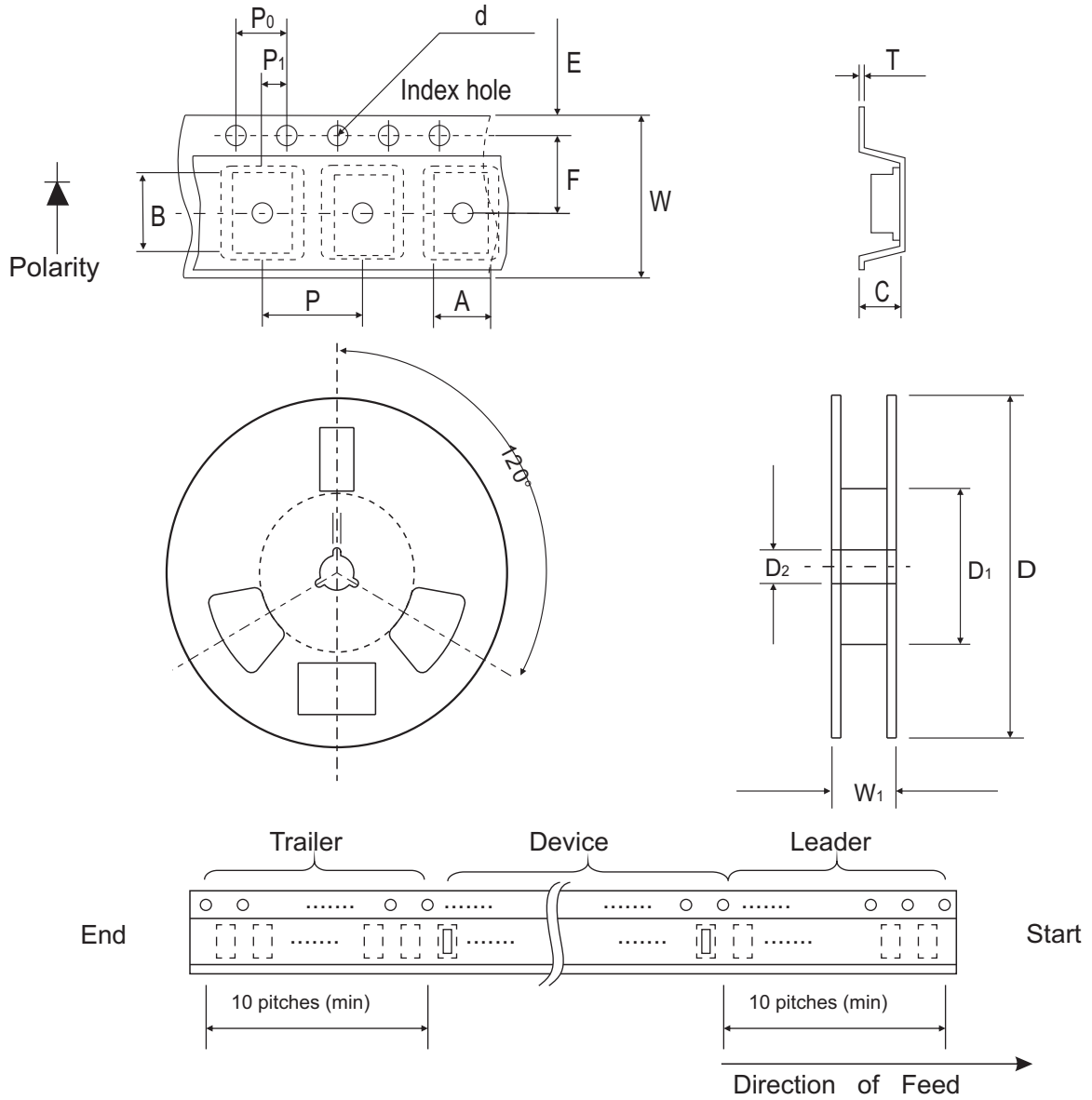

Fig. 3 Zener voltage-temp. Coefficient characteristics

## Reel Taping Specification



0503 (SOD-723F)	SYMBOL	A	B	C	d	D	D <sub>1</sub>	D <sub>2</sub>
	(mm)	0.90 ± 0.10	1.46 ± 0.10	0.80 ± 0.10	1.55 ± 0.05	178 ± 1	60.0 MIN.	13.0 ± 0.20
	(inch)	0.035 ± 0.004	0.057 ± 0.004	0.031 ± 0.004	0.061 ± 0.002	7.008 ± 0.04	2.362 MIN.	0.512 ± 0.008

0503 (SOD-723F)	SYMBOL	E	F	P	P <sub>0</sub>	P <sub>1</sub>	T	W	W <sub>1</sub>
	(mm)	1.75 ± 0.10	3.50 ± 0.05	4.00 ± 0.10	4.00 ± 0.10	2.00 ± 0.10	0.22 ± 0.05	8.00 ± 0.20	13.5 MAX.
	(inch)	0.069 ± 0.004	0.138 ± 0.002	0.157 ± 0.004	0.157 ± 0.004	0.079 ± 0.004	0.008 ± 0.002	0.315 ± 0.008	0.531 MAX.

## Suggested PAD Layout

SIZE	0503/SOD-723F	
	(mm)	(inch)
A	0.85	0.033
B	0.55	0.022
C	0.85	0.033
D	1.40	0.055
E	0.30	0.012

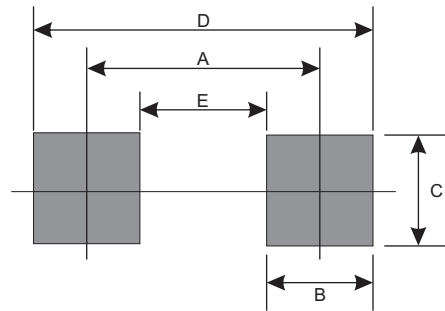

## Standard Package

Case Type	Qty per Reel	Reel Size
	(Pcs)	(inch)
0503/SOD-723F	4000	7

# Mouser Electronics

Authorized Distributor

Click to View Pricing, Inventory, Delivery & Lifecycle Information:

## Comchip Technology:

[CZRER10VB-HF](#) [CZRER11VB-HF](#) [CZRER12VB-HF](#) [CZRER13VB-HF](#) [CZRER15VB-HF](#) [CZRER16VB-HF](#)  
[CZRER18VB-HF](#) [CZRER20VB-HF](#) [CZRER22VB-HF](#) [CZRER24VB-HF](#) [CZRER27VB-HF](#) [CZRER2V4B-HF](#)  
[CZRER2V7B-HF](#) [CZRER30VB-HF](#) [CZRER33VB-HF](#) [CZRER36VB-HF](#) [CZRER39VB-HF](#) [CZRER3V0B-HF](#)  
[CZRER3V3B-HF](#) [CZRER3V6B-HF](#) [CZRER3V9B-HF](#) [CZRER4V3B-HF](#) [CZRER4V7B-HF](#) [CZRER5V1B-HF](#)  
[CZRER5V6B-HF](#) [CZRER6V2B-HF](#) [CZRER6V8B-HF](#) [CZRER7V5B-HF](#) [CZRER8V2B-HF](#) [CZRER9V1B-HF](#)