

# DELPHI SERIES



## FEATURES

- High efficiency:  
91.5% @ 11Vin, 1.8V/30A out  
88% @ 11Vin, 1.0V/30A out
- Small size and low profile:  
(1.0" x 0.5" x 0.48") (SMD)
- Surface mount
- No minimum load required
- Input: UVLO, Output OCP/SCP, OVP, OTP
- Parallel Units
- ISO 9000, TL 9000, ISO 14001 certified manufacturing facility
- UL/cUL 60950-1 (US & Canada) Recognized, and TUV (EN60950-1) Certified
- CE mark meets 73/23/EEC and 93/68/EEC directives

## D12S1R830, Non-Isolated, Power Block DC/DC Power Modules: 7.0~13.2Vin, 0.8V~1.8V/30Aout

The Delphi D12S1R830, surface mounted, power block is the latest offering from a world leader in power systems technology and manufacturing — Delta Electronics, Inc. The D12S1R830 is the latest offering in the DXP30 family which was developed to address the ever-growing demands of increased current and power densities in networking applications while providing maximum flexibility for system configuration, its benefits can easily be applied to other applications transcending various market segments. The DXP30 family, containing all necessary power components and boasting of a USABLE (55°C, 200LFM) current density of 60A/in<sup>2</sup> and a power density of up to 216W/in<sup>3</sup>, is a building block for a new open Digital Power Architecture developed to work with either digital or analog controllers. Measured at 0.5"Wx1.0"Lx0.48"H and rated at 30A of output current, the D12S1R830 is designed to operate with an input voltage from 7V to 13.2V and provide an output voltage adjustable from 0.8V to 1.8V in digitally defined step resolution of 1.62mV. Multiple D12S1R830 can be used in parallel to serve applications where output currents are in excess of 30A with limitation imposed only by the control circuit, analog or digital. Designed for superior price/performance, the D12S1R830 can provide 1.8V and 30A full load in ambient temperature up to 55°C with 200LFM airflow.

## APPLICATIONS

- Telecom / DataCom
- Distributed power architectures
- Servers and workstations
- LAN / WAN applications
- Data processing applications

DATASHEET  
DS\_D12S1R830D\_01132011

# TECHNICAL SPECIFICATIONS

T<sub>A</sub> = 25°C, airflow rate = 200 LFM, V<sub>in</sub> = 7~13.2Vdc, nominal V<sub>out</sub> unless otherwise noted.

PARAMETER	NOTES and CONDITIONS	D12S1R830			
		Min.	Typ.	Max.	Units
<b>ABSOLUTE MAXIMUM RATINGS</b>					
Input Voltage (Continuous)		0		15	Vdc
Operating Temperature	Refer to Fig.15 for the measuring point	0		113	°C
Storage Temperature		-40		125	°C
<b>INPUT CHARACTERISTICS</b>					
Operating Input Voltage		7.0	11.0	13.2	V
Maximum Input Current	V <sub>in</sub> =7V, V <sub>out</sub> =1.8V, I <sub>out</sub> =30A			8.7	A
PWM	Pin 3	4.5	5.0	5.5	V
Gate Voltage	Pin 5 (reference to ground)	6.7	7.0	7.5	Vdc
<b>OUTPUT CHARACTERISTICS</b>					
Output Voltage Adjustable Range	V <sub>in</sub> =11.0V	0.8		1.8	V
Total Output Voltage Regulation	Total Regulation over load, line and temperature	-1		+1	%V
Output Voltage Ripple and Noise	3x 560µF OSCON and 320µF ceramic capacitor,		15		mVpp
Output Voltage Overshoot	@ turn on		0	0.5	%V
Output Current Range		0		30	A
Transient Response	V <sub>in</sub> = 11.0V; I <sub>out</sub> Step: 0~30A; Slew/Rate: 10A/µS		200		mVpp
Inductor Value			375		nH
Inductor DCR			0.54		mΩ
Inductor Peak Current	Inductor temperature of 125°C			40	A
Temperature sense	25°C, 495µA bias current	1.345	1.35	1.355	V
<b>EFFICIENCY</b>					
	V <sub>in</sub> =7V, V <sub>o</sub> =1.0V, I <sub>o</sub> =30A		87.9		%
	V <sub>in</sub> =11.0V, V <sub>o</sub> =1.0V, I <sub>o</sub> =30A		88.0		%
	V <sub>in</sub> =13.2V, V <sub>o</sub> =1.0V, I <sub>o</sub> =30A		87.8		%
	V <sub>in</sub> =7.0V, V <sub>o</sub> =1.8V, I <sub>o</sub> =30A		90.9		%
	V <sub>in</sub> =11.0V, V <sub>o</sub> =1.8V, I <sub>o</sub> =30A		91.5		%
	V <sub>in</sub> =13.2V, V <sub>o</sub> =1.8V, I <sub>o</sub> =30A		91.4		%
<b>FEATURE CHARACTERISTICS</b>					
Operating Frequency			400		kHz
<b>GENERAL SPECIFICATIONS</b>					
MTBF	V <sub>o</sub> =1.8V, I <sub>o</sub> =30A, T <sub>a</sub> =25 °C, 100LFM		22.49		M hours
Weight			6.4		grams

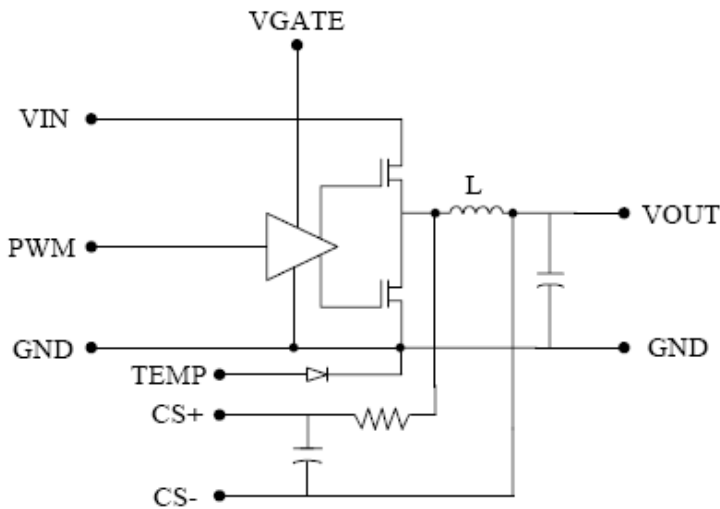

Block diagram of D12S1R830D



## ELECTRICAL CHARACTERISTICS CURVES

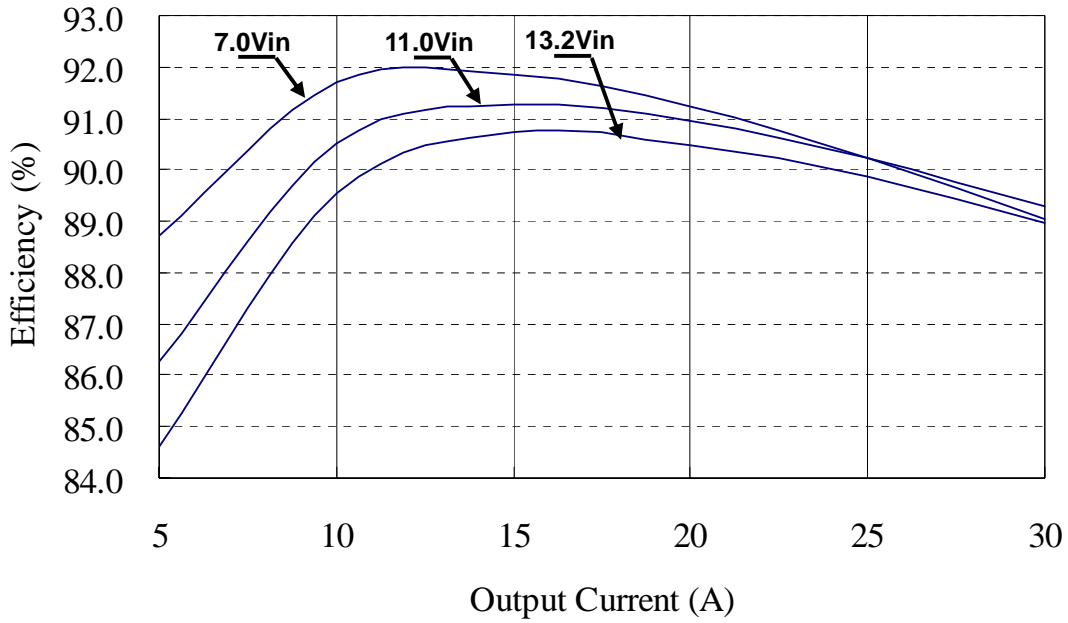

Figure 1: Efficiency vs. load current for minimum, nominal, and maximum input voltage, 1.0V output voltage at 25°C.

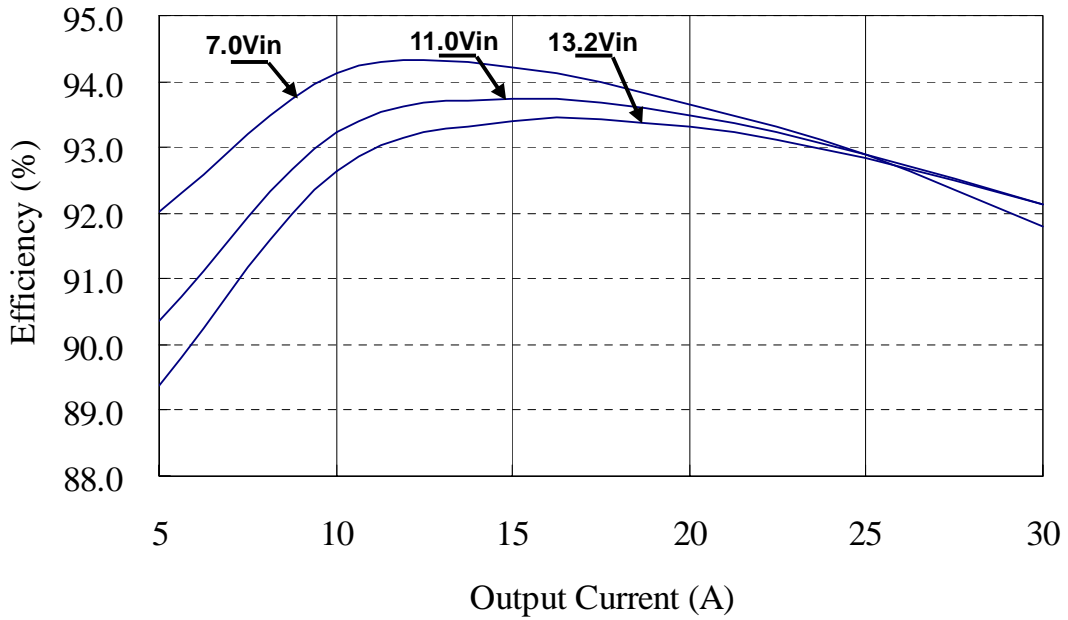
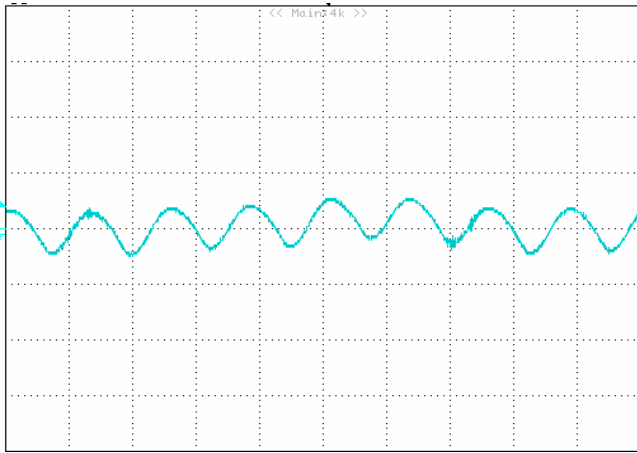

Figure 2: Efficiency vs. load current for minimum, nominal, and maximum input voltage, 1.8V output voltage at 25°C.



## ELECTRICAL CHARACTERISTICS CURVES



**Figure 3: Output Ripple & Noise**  
Input Voltage=11V, Vout=1.0V, Iout=0 A, 2uS/div, 10mV/div

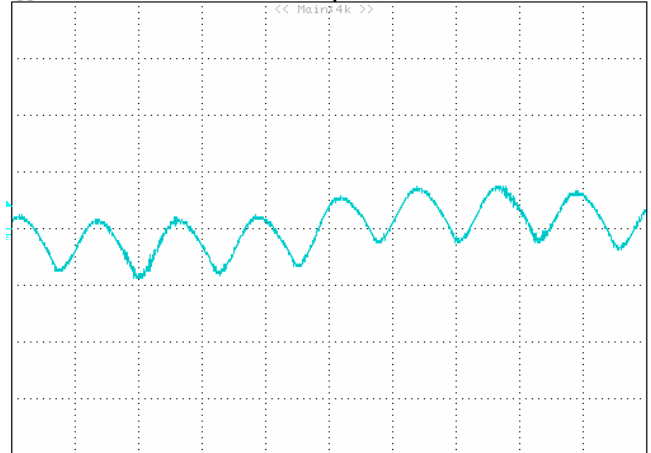

**Figure 4: Output Ripple & Noise**  
Input Voltage=11V, Vout=1.0V, Iout=30 A, 2uS/div, 10mV/div

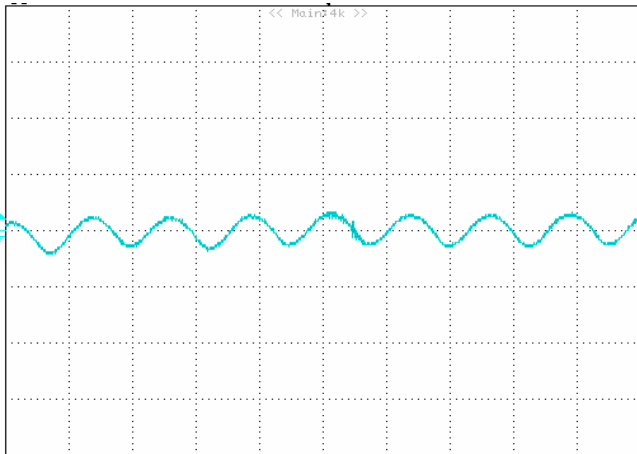

**Figure 5: Output Ripple & Noise**  
Input Voltage=11V, Vout=1.8V, Iout=0 A, 2uS/div, 10mV/div

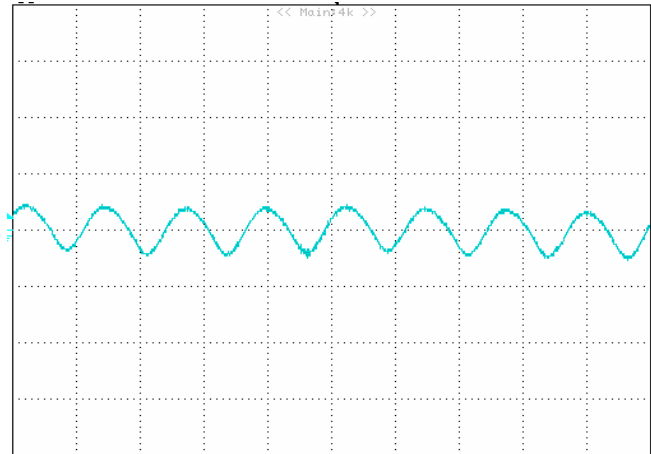

**Figure 6: Output Ripple & Noise**  
Input Voltage=11V, Vout=1.8V, Iout=30 A, 2uS/div, 10mV/div



## ELECTRICAL CHARACTERISTICS CURVES

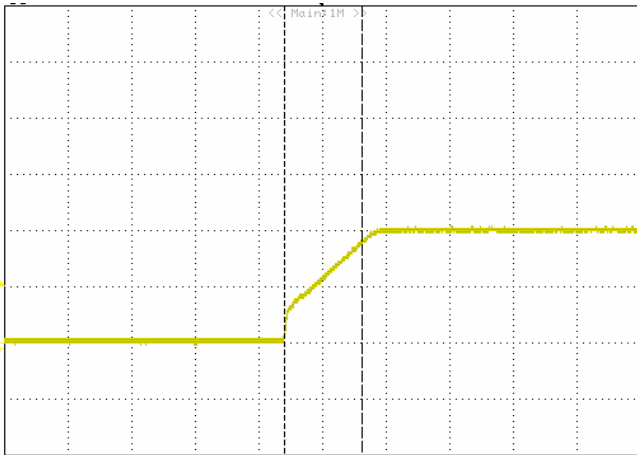

**Figure 7:** Output Rise Time: 1 pcs Converter on test board.  
( $V_{in} = 11.0V$ ; 1V Output Voltage;  $I_{out} = 30A$ ), 1mS/div, 0.5V/div

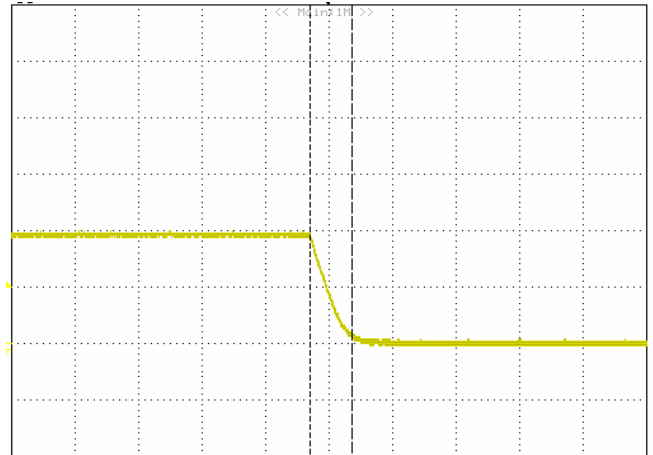

**Figure 8:** Output Fall Time: 1 pcs Converter on test board.  
( $V_{in} = 11.0V$ ; 1V Output Voltage;  $I_{out} = 30A$ ), 500uS/div, 0.5V/div

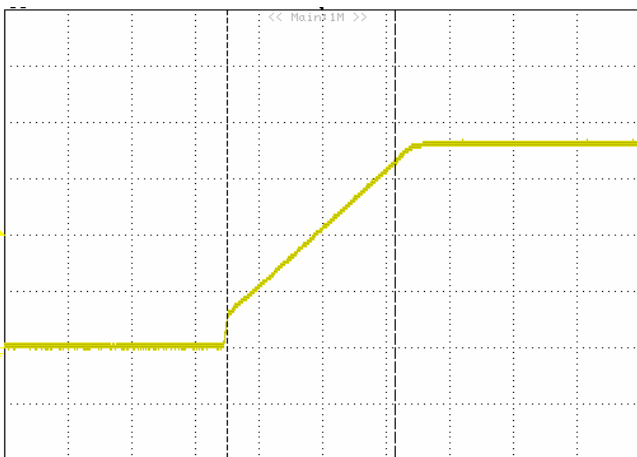

**Figure 9:** Output Rise Time: 1 pcs Converter on test board.  
( $V_{in} = 11.0V$ ; 1.8V Output Voltage;  $I_{out} = 30A$ )  
1mS/div, 0.5V/div

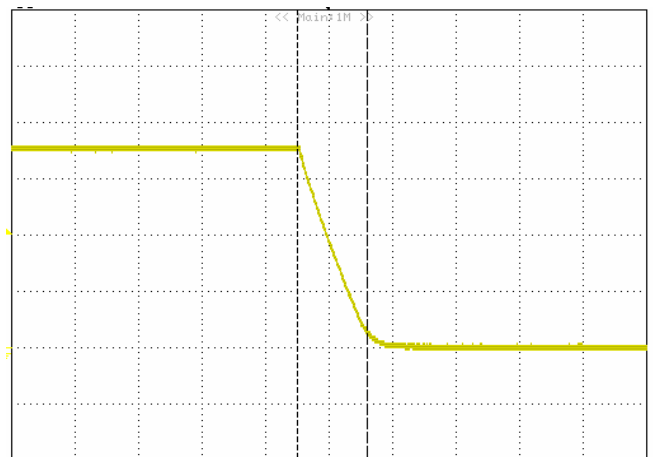

**Figure 10:** Output Fall Time: 1 pcs Converter on test board.  
( $V_{in} = 11.0V$ ; 1.8V Output Voltage;  $I_{out} = 30A$ )  
500uS/div, 0.5V/div



## TEST CONFIGURATIONS

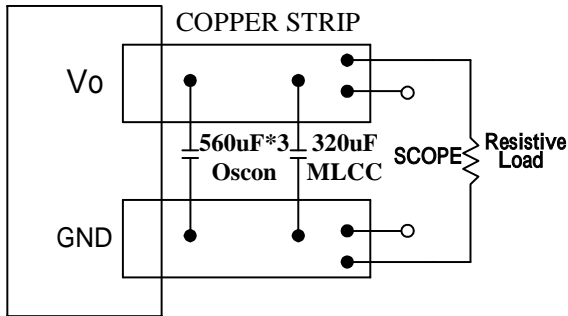

**Figure 11:** Peak-peak output ripple & noise and startup transient measurement test setup

Note: 3pcs 560µF OSCON and 320µF MLCC capacitor in the module output. Scope measurement should be made by using a BNC connector.

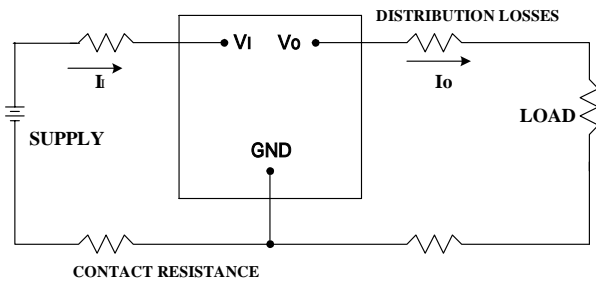

**Figure 12:** Output voltage and efficiency measurement test setup

Note: All measurements are taken at the module terminals. When the module is not soldered (via socket), place Kelvin connections at module terminals to avoid measurement errors due to contact resistance.

$$\eta = \left( \frac{V_o \times I_o}{V_i \times I_i} \right) \times 100 \quad \%$$

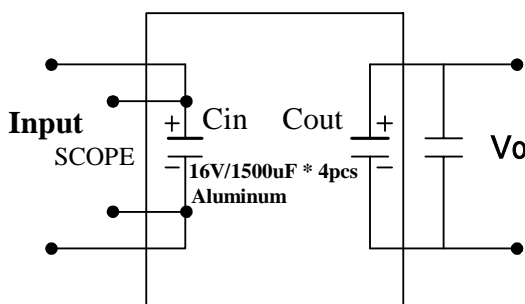

**Figure 13:** Peak-peak Input ripple & noise measurement test setup

Note: 4pcs 1,000µF Aluminum in the module input. Scope measurement should be made by using a BNC connector.

## DESIGN CONSIDERATIONS

The power module should be connected to a low ac-impedance input source. Highly inductive source impedances can affect the stability of the module. An input capacitance must be placed close to the modules input pins to filter ripple current and ensure module stability in the presence of inductive traces that supply the input voltage to the module.

### Safety Considerations

For safety-agency approval the power module must be installed in compliance with the spacing and separation requirements of the end-use safety agency standards.

For the converter output to be considered meeting the requirements of safety extra-low voltage (SELV), the input must meet SELV requirements. The power module has extra-low voltage (ELV) outputs when all inputs are ELV.

The input to these units is to be provided with a maximum 15A time-delay fuse in the ungrounded lead.

## FEATURES DESCRIPTIONS

### Over-Current Protection

To provide protection in an output over load fault condition, the unit is equipped with internal over-current protection. When the over-current protection is triggered, the unit will be shutdown and restart by input or OUTEN on/off. The units operate normally once the fault condition is removed.

### Over-Temperature Protection

To provide additional over-temperature protection in a fault condition, the unit is equipped with a latching thermal shutdown circuit. The shutdown circuit engages when the temperature of monitored component exceeds approximately 130 . The shutdown unit will restart by input or OUTEN on/off while the temperature lower than 125C.



## THERMAL CONSIDERATIONS

Thermal management is an important part of the system design. To ensure proper, reliable operation, sufficient cooling of the power module is needed over the entire temperature range of the module. Convection cooling is usually the dominant mode of heat transfer.

Hence, the choice of equipment to characterize the thermal performance of the power module is a wind tunnel.

### Thermal Testing Setup

Delta's DC/DC power modules are characterized in heated wind tunnels that simulate the thermal environments encountered in most electronics equipment.

The following figures show the wind tunnel characterization setup. The power module is mounted on Primarion test board and is horizontally positioned within the wind tunnel.

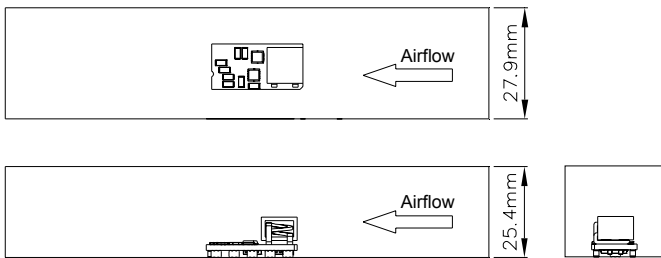

Figure 14: Wind Tunnel Test Setup

## Thermal De-rating

The module's maximum hot spot temperature is +113°C. To enhance system reliability, the power module should always be operated below the maximum operating temperature. If the temperature exceeds the maximum module temperature, reliability of the unit may be affected.

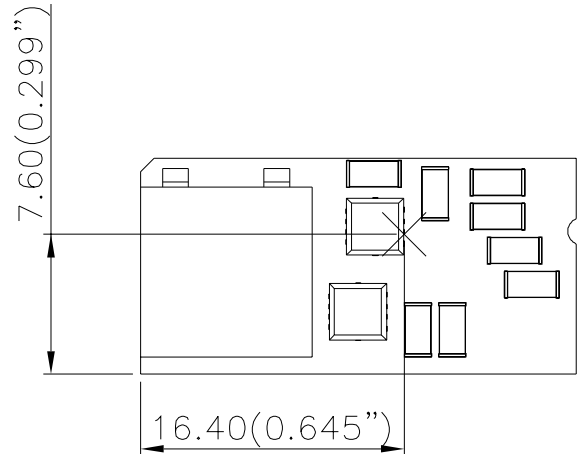

Figure 15: Temperature measurement location  
The allowed maximum hot spot temperature is defined at 113



# THERMAL CURVES

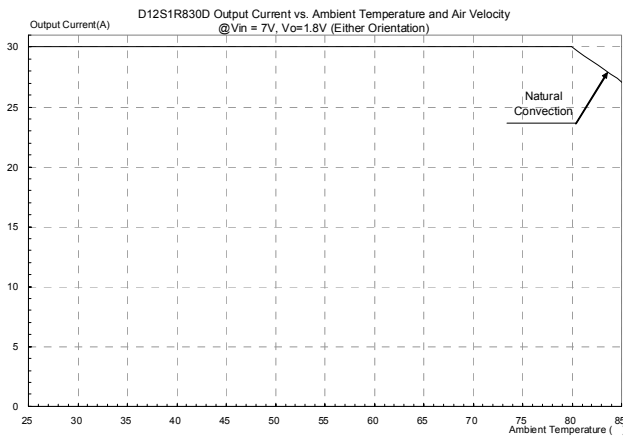

Figure 16: Output current vs. ambient temperature and air velocity @ V<sub>in</sub>=7V, V<sub>out</sub>=1.8V (Either Orientation)

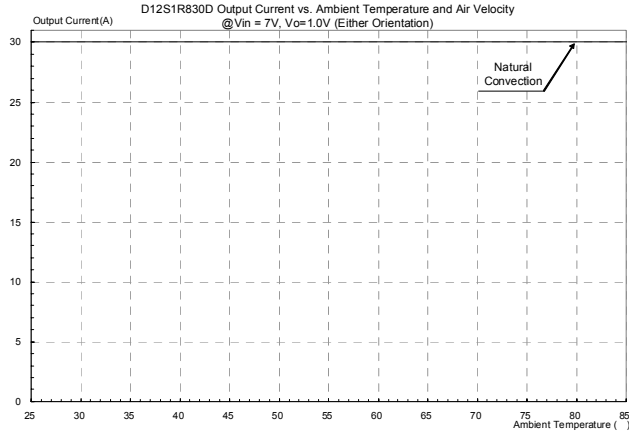

Figure 17: Output current vs. ambient temperature and air velocity @ V<sub>in</sub>=7V, V<sub>out</sub>=1.0V (Either Orientation)

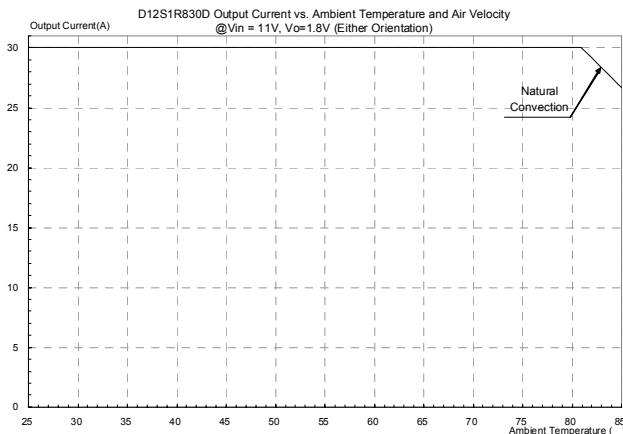

Figure 18: Output current vs. ambient temperature and air velocity @ V<sub>in</sub>=11V, V<sub>out</sub>=1.8V (Either Orientation)

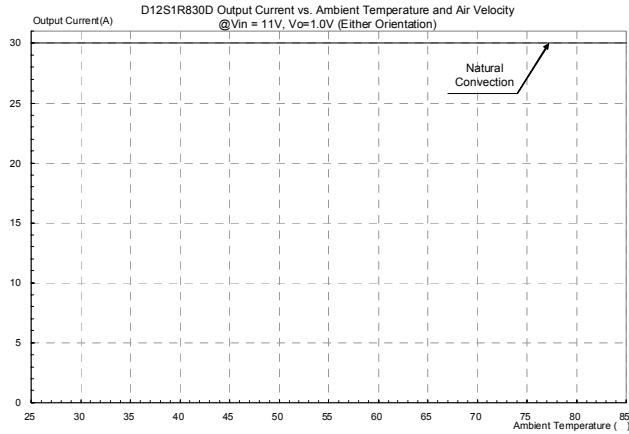

Figure 19: Output current vs. ambient temperature and air velocity @ V<sub>in</sub>=11V, V<sub>out</sub>=1.0V (Either Orientation)

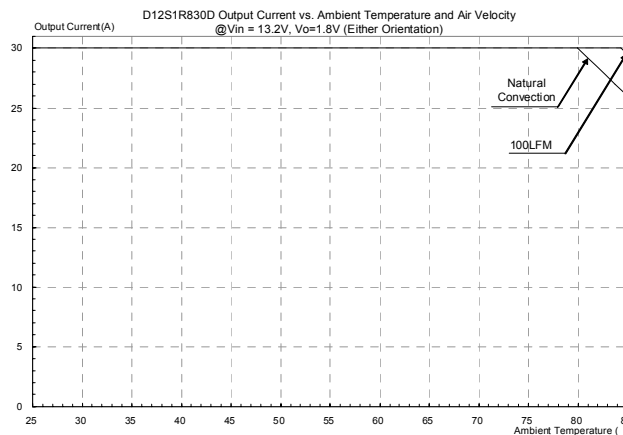

Figure 20: Output current vs. ambient temperature and air velocity @ V<sub>in</sub>=13.2V, V<sub>out</sub>=1.8V (Either Orientation)

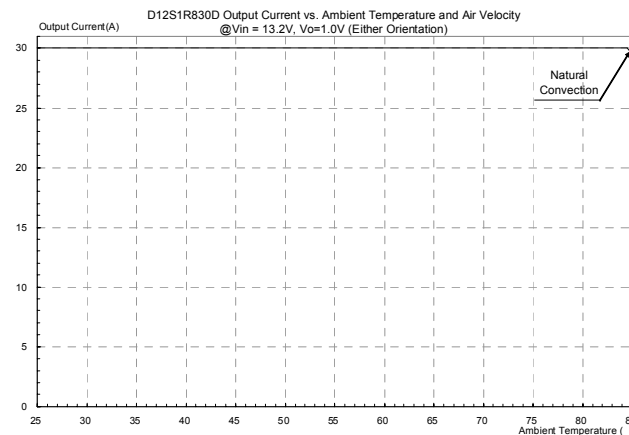
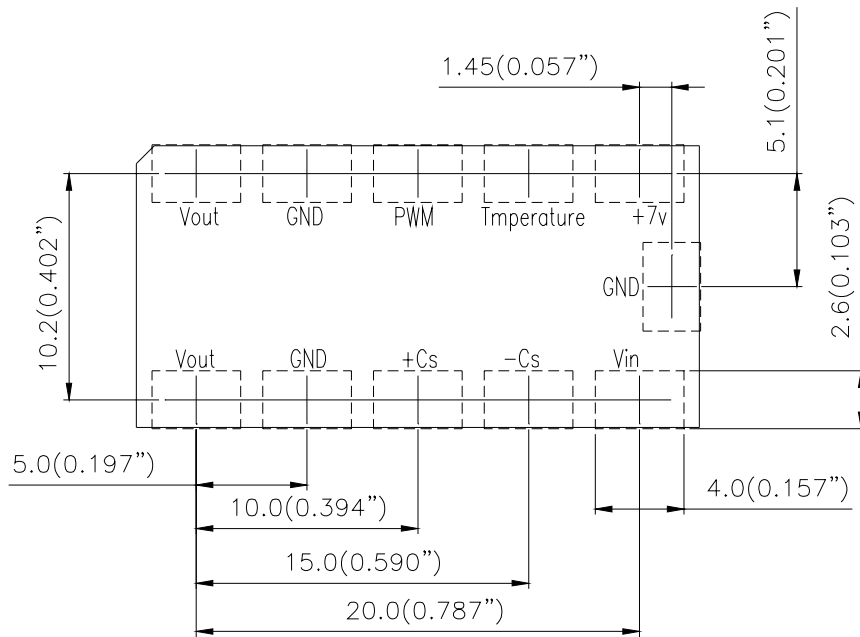
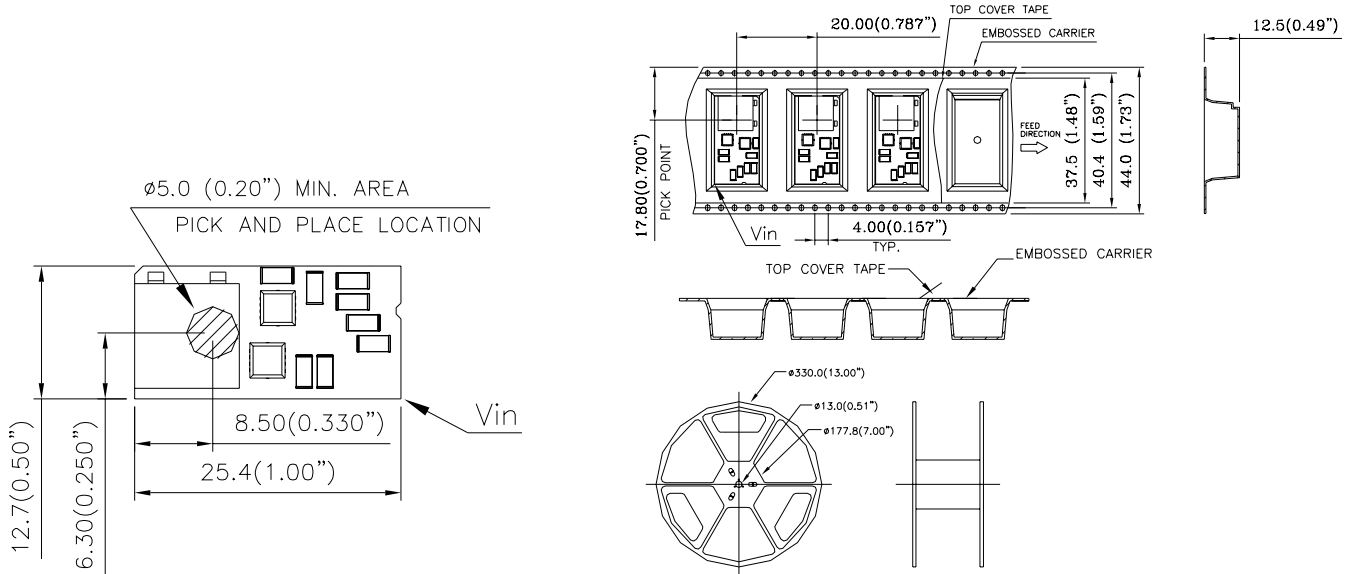

Figure 21: Output current vs. ambient temperature and air velocity @ V<sub>in</sub>=13.2V, V<sub>out</sub>=1.0V (Either Orientation)



# MECHANICAL CONSIDERATIONS

## SURFACE-MOUNT TAPE & REEL



RECOMMENDED P.W.B PAD LAYOUT



# MECHANICAL DRAWING

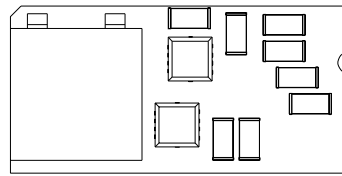

TOP VIEW

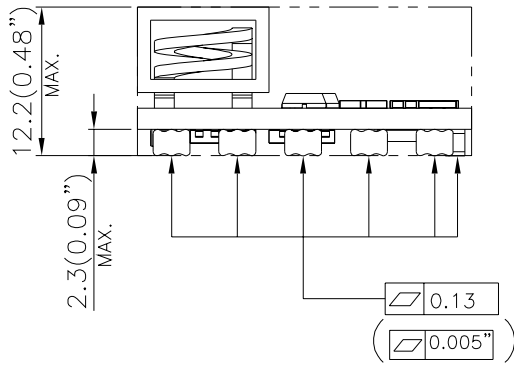
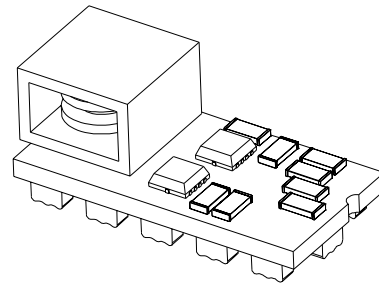

SIDE VIEW

PIN#	Function
1	Vout
2	GND
3	PWM
4	Temperature
5	+7V
6	Vin
7	-Cs
8	+Cs
9	GND
10	Vout
11	GND

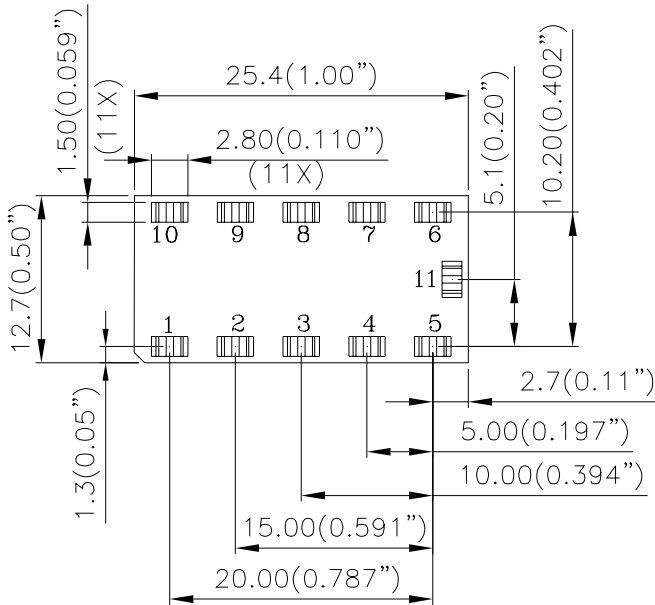

BOTTOM VIEW

NOTES:  
 DIMENSIONS ARE IN MILLIMETERS AND (INCHES)  
 TOLERANCES: X.Xmm±0.5mm(X.XX in.±0.02 in.)  
 X.XXmm±0.25mm(X.XXX in.±0.010 in.)



## PART NUMBERING SYSTEM

<b>D</b>	<b>12</b>	<b>S</b>	<b>1R8</b>	<b>30</b>	<b>D</b>
<b>Type of Product</b>	<b>Input Voltage</b>	<b>Number of Outputs</b>	<b>Output Voltage</b>	<b>Output Current</b>	<b>Option Code</b>
D - DC/DC modules	12 - 7 ~13.2V	S - Single	1R8 - 0.8~1.8V	30 - 30A max	D- Standard P Block

## MODEL LIST

Model Name	Input Voltage	Output Voltage	Output Current	RoHS	Total Height	Efficiency 9.6Vin, 1.8Vout @ 100% load
D12S1R830D	7.0 ~ 13.2Vdc	0.8V ~ 1.8V	30A	RoHS 5/6	0.48"	91.5%

### CONTACT: [www.delta.com.tw/dcdc](http://www.delta.com.tw/dcdc)

#### USA:

Telephone:  
 East Coast: (888) 335 8201  
 West Coast: (888) 335 8208  
 Fax: (978) 656 3964  
 Email: [DCDC@delta-corp.com](mailto:DCDC@delta-corp.com)

#### Europe:

Phone: +41 31 998 53 11  
 Fax: +41 31 998 53 53  
 Email: [DCDC@delta-es.com](mailto:DCDC@delta-es.com)

#### Asia & the rest of world:

Telephone: +886 3 4526107  
 ext 6220~6224  
 Fax: +886 3 4513485  
 Email: [DCDC@delta.com.tw](mailto:DCDC@delta.com.tw)

## WARRANTY

Delta offers a two (2) year limited warranty. Complete warranty information is listed on our web site or is available upon request from Delta.

Information furnished by Delta is believed to be accurate and reliable. However, no responsibility is assumed by Delta for its use, nor for any infringements of patents or other rights of third parties, which may result from its use. No license is granted by implication or otherwise under any patent or patent rights of Delta. Delta reserves the right to revise these specifications at any time, without notice.