

Digi Connect ME[®] Family

Wired and Wireless Device Server Modules

The industry's first interchangeable, secure wired and wireless device server modules with plug-and-play functionality and professional development tools for custom applications.



Overview

The Digi Connect ME family of secure device server modules delivers complete and versatile embedded IPv6-ready network connectivity. The modules are cost effective and easy to use in existing and new product designs, while powerful enough to meet future product performance needs. Target applications include retail systems, security/access control, medical devices and building/industrial automation.

Form factor compatibility allows the drop-in replacement of a wired or wireless module in your product design. The modules offer true long-term product availability and state-of-the-art wired and wireless security capabilities such as SSL/TLS and WPA2/802.11i.

Built on Digi's 32-bit NET+ARM processors, the modules deliver off-the-shelf serial-to-network functionality through Digi's plug-and-play firmware, and the freedom and flexibility of professional embedded development provided by the easy-to-use and cost-effective Digi JumpStart Kits[®] for NET+OS[®] and .NET Micro Framework.

Block Diagram

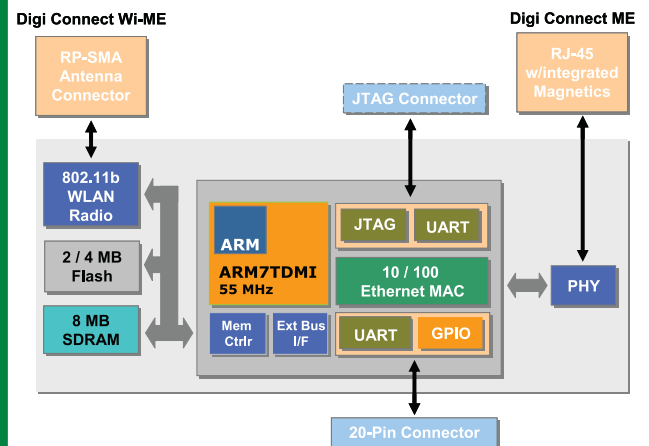

Features/Benefits

- Compact and secure 32-bit device server modules
- Complete family of pin-compatible module solutions
- 10/100 Ethernet interface or 802.11b WLAN interface
- Strong WPA2/802.11i security (PSK and Enterprise)
- Highly integrated low emission design (FCC Class B)
- Extended and industrial operating temperature
- Digi processor and WLAN technology for true long-term availability
- Seamless migration path to NET+ARM chip design

Platforms and Services



Design Services



Accessory Kits



Support

NET+OS

PLUG-and-PLAY
FIRMWARE



Microsoft
.NET
Micro
Framework

Supported Software Platforms



www.digi.com

Integration Kits and Digi JumpStart Kits®: Overview

Plug-and-Play Integration Kits	Digi JumpStart Kit® for NET+OS®	Digi JumpStart Kit® for Microsoft .NET Micro Framework
<p>Digi Integration Kits provide everything needed for evaluation, rapid prototyping and integration of Digi Connect device server modules using the feature-rich Digi plug-and-play device server firmware. They deliver fully transparent wired and wireless serial-to-network functionality and allow you to quickly network-enable your existing and new product designs.</p> <p>Digi plug-and-play firmware offers industry-leading features such as a robust IPv6-ready TCP/IP stack, fully-featured serial tunneling, Modbus/TCP, web user interface with private labeling/branding options, user management, file system, SSL/TLS, SSH, Modbus/TCP, intelligent device management via SNMP, configurable e-mail alarms, and patented RealPort® COM/TTY port redirection.</p> <ul style="list-style-type: none"> • Complete kit for product evaluation, rapid prototyping, and integration • Digi plug-and-play firmware eliminates embedded software development • Transparent wired and wireless device server functionality • Full private-labeling/branding supported out-of-the-box 	<p>This royalty-free turnkey solution for embedded software development is based on the ThreadX Real-Time Operating System (RTOS), one of the most reliable and field-proven RTOS solutions available. In addition to ThreadX, NET+OS provides the integrated building blocks needed to create product solutions with leading network security using Digi embedded modules and microprocessors.</p> <p>For professional NET+OS software development, the Microsoft Windows based Digi ESP™ Integrated Development Environment (IDE), with graphical user interface and a high-speed USB 2.0 hardware debugger, is provided out-of-the-box.</p> <ul style="list-style-type: none"> • Royalty-free turnkey solution for embedded software development • Built on field-proven and compact ThreadX RTOS • Fully integrated support for secure, IPv4/IPv6 networking applications • Professional software development using Windows-based Digi ESP IDE 	<p>This complete off-the-shelf development solution enables easy Microsoft .NET Micro Framework embedded software development. The kit includes a fully functional 90-day trial of Microsoft Visual Studio® 2005.</p> <p>Built on the .NET foundation and optimized for use in small intelligent devices, the .NET Micro Framework combines the reliability and efficiency offered by a .NET enabled C# managed code environment with the professional Visual Studio development tools. It makes rapid embedded application development accessible to software designers with experience on Microsoft desktop and server operating system platforms.</p> <ul style="list-style-type: none"> • Complete and royalty-free embedded development solution • Robust managed code environment based on .NET programming model • Digi TCP/IP network stack and platform-specific extensions • State-of-the-art software development using Microsoft Visual Studio 2005 

Digi JumpStart Kit® and Integration Kit Contents

Software Platform	Digi Plug-and-Play Device Server Firmware	NET+OS®	.NET Micro Framework
Module	Digi Connect ME or Digi Connect Wi-ME module w/ 2 MB Flash, 8 MB SDRAM		Digi Connect ME module w/ 2 MB Flash, 8 MB SDRAM
Development Board	1 RS-2323 serial port, GPIO configuration switches, Screw terminal for GPIO signals, Prototyping area, Status LEDs (serial, GPIO, power), Logic signal header, Test points, Reset button, User buttons, PoE module header, 9-30VDC power supply, JTAG header and RS-232 console/debug port for JTAG-equipped modules		
CD/DVD	Digi Connect Integration Kit CD: Device discovery tool w/source code, Device discovery library, Java applet sample source code, C/C++ samples, (TCP, UDP, SSL)	Digi NET+OS CD: NET+OS 7, Digi ESP IDE, BSP source code, Sample code, Green Hills MULTI IDE support files, User documentation	Digi .NET Micro Framework CD: Platform support, Templates and samples, Documentation Microsoft Visual Studio 2005 CD with 90-day trial license
Documentation	Getting started, Hardware reference manual, Development board schematics Digi Connect user's guide, Command line reference, RCI specification	Quick start guide, Digi ESP tutorial, NET+OS porting guide, NET+OS API documentation, Advanced Web Server, Hardware reference manual, Development board schematics	Quick start guide, Getting started guide, Hardware reference manual, Development board schematics
Power Supplies	External wall power supply (110/240VAC to 12VDC @ 850 mA) with interchangeable outlet adapters (North America, EU, UK, and Australia)		
Accessories	Crossover serial cable, Ethernet cable or 2 dBi dipole antenna		
Other	-	Digi JTAG link USB 2.0 hardware debugger	-
Kit Part Numbers			
Ethernet Only	DC-ME-KT	DC-ME-NET	DC-ME-MF
WLAN + Ethernet	DC-WME-KT	DC-WME-NET	-

Please refer to the feature specs on our website for detailed information about the specific software platform capabilities.

Hardware		
Processor Type	32-bit Digi NS7520 processor	
ARM Core	ARM7TDMI	
Processor Speed	55 MHz	
Memory Base Population	2/4 MB NOR flash	4 MB NOR flash
	8 MB SDRAM	
Pins/Form Factor	RJ-45 connector style with 20-pin micro pin header (Samtec FTS-110-01-F-DV-TR)	
High-Speed TTL Serial Interface	Up to 230 Kbps data rate Full signal support for TXD, RXD, RTS, CTS, DTR, DSR and DCD Hardware/Software flow control	
GPIO	Up to 10 shared with 1 external IRQ	
On-module Power Supervisor	•	
JTAG Interface	NET+OS development modules only (P/N DC-ME-01T-JT, DC-ME4-01T-JT)	
Wave-Solderable Design	No clean flux process	
Dimensions (L x W x H)	1.445 in (36.7 mm) x 0.75 in (19.05 mm) x 0.854 in (21.69 mm)	1.845 in (46.86 mm) x 0.75 in (19.05 mm) x 0.854 in (21.69 mm)
Network Interface - Wired		
Standard	IEEE 802.3	—
Physical Layer	10/100Base-T	—
Data Rate	10/100 Mbps (auto-sensing)	—
Mode	Full- or half-duplex (auto-sensing)	—
Connector	RJ-45	—
Integrated Ethernet MAC/PHY	•	—
PoE Power Pass-Through	• See website for available options	—
Network Interface – Wireless LAN		
Standard	—	IEEE 802.11b
Frequency	—	2.4 GHz
Data Rate	—	Up to 11 Mbps with automatic fallback
Modulation	—	CCK (11/5.5 Mbps), DQPSK (2 Mbps), DBPSK (1 Mbps)
Typical Transmit Power	—	16 dBm typical
Receive Sensitivity	—	-82 dBm @ 11 Mbps
Connector	—	1 x RP-SMA
WLAN Security		
WEP (Wired Equivalent Privacy)	—	64/128-bit encryption (RC4)
WPA/WPA2/802.11i	—	128-bit TKIP/CCMP (AES) encryption Enterprise mode (802.1X): LEAP (WEP only), PEAP, TTLS, TLS; EAP-FAST, GTC, MD5, OTP, PAP, CHAP, MSCHAP, MSCHAPv2, TTLS-MSCHAPv2 Pre-shared key mode (PSK/Personal)

Platform	Digi Connect ME®	Digi Connect® Wi-ME
Environmental		
Operating Temperature	-40° C to +85° C (-40° F to +185° F)	-30° C to +75° C (-22° F to +167° F)
Storage Temperature	-50° C to +125° C (-58° F to +257° F)	
Relative Humidity	5% to 90% (non-condensing)	
Altitude	12,000 feet (3,658 meters)	
Power Requirements (3.3V)		
Maximum	270 mA (891 mW)	400 mA (1.32 W)
Regulatory Approvals		
FCC Part 15 Class B, EN 55022 Class B		•
EN 61000-3-2 and EN 61000-3-3		•
ICES-003 Class B, VCCI Class II, AS 3548		•
FCC Part 15 Sub C Section 15.247		•
IC RSS-210 Issue 5 Section 6.2.2(o)		•
EN 300 328, EN 301 489-17		•
UL 60950-1, EN 60950 (EU)		•
CSA C22.2, No. 60950		•
EN 55024		•

• Module Feature

Digi Connect ME® - Side

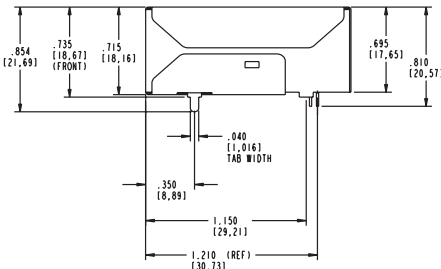

Digi Connect® Wi-ME - Bottom

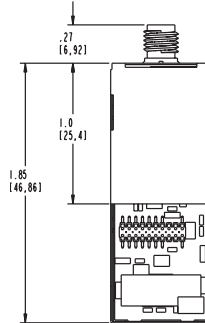

Recommended PCB Layout

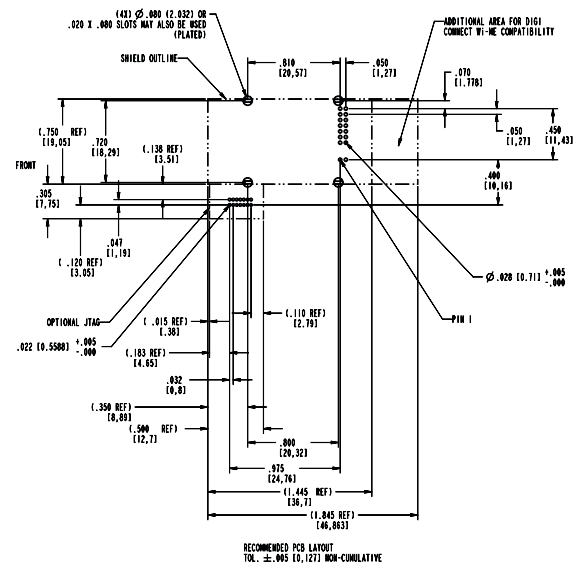

Visit www.digiembedded.com for part numbers.

DIGI SERVICE AND SUPPORT - You can purchase with confidence knowing that Digi is here to support you with expert technical support and a strong five-year warranty. www.digi.com/support

Digi International
877-912-3444
952-912-3444
info@digi.com

Digi International France
+33-1-55-61-98-98
www.digi.fr

Digi International KK
+81-3-5428-0261
www.digi-intl.co.jp

Digi International (HK) Limited
+852-2833-1008
www.digi.cn

BUY ONLINE • www.digiembedded.com



91001258
E2/1009



© 2004-2009 Digi International Inc. Digi, Digi International, the Digi logo, the Making Wireless M2M Easy logo, Digi Connect, Digi Connect ME, Digi JumpStart Kit, Digi ESP, NET+, NET+OS and RealPort are trademarks or registered trademarks of Digi International Inc. in the United States and other countries worldwide. ARM and NET+ARM are trademarks or registered trademarks of ARM Limited. All other trademarks are the property of their respective owners.