

Features

- Very Tight Tolerance on V_Z
- Ideally Suited for Automated Assembly Processes
- 500mW Power Dissipation on FR-4 PCB (Note 1)
- **Totally Lead-Free & Fully RoHS Compliant (Notes 2 & 3)**
- **Halogen and Antimony Free. "Green" Device (Notes 4)**
- **Qualified to AEC-Q101 Standards for High Reliability**
- **PPAP Capable (Note 5)**

Mechanical Data

- Case: SOD123
- Case Material: Molded Plastic, "Green Molding Compound". UL Flammability Classification Rating 94V-0
- Moisture Sensitivity: Level 1 per J-STD-020
- Terminal Connections: Cathode Band
- Terminals: Finish - Matte Tin Annealed over Alloy 42 Leadframe. Solderable per MIL-STD-202, Method 208
- Weight: 0.01 grams (Approximate)

SOD123



Top View

Ordering Information (Notes 5 & 6)

Part Number	Qualification	Case	Packaging
DDZ(V_Z Rank)-7*	Commercial	SOD123	3,000/Tape & Reel
DDZ(V_Z Rank)Q-7*	Automotive	SOD123	3,000/Tape & Reel

* Example: The part number for the 6.2 Volt device would be DDZ6V2B-7.

- Notes:
1. Device mounted on FR-4 PC board with 4" x 4" copper pads.
 2. No purposely added lead. Fully EU Directive 2002/95/EC (RoHS) & 2011/65/EU (RoHS 2) compliant.
 3. See http://www.diodes.com/quality/lead_free.html for more information about Diodes Incorporated's definitions of Halogen- and Antimony-free, "Green" and Lead-free.
 4. Halogen- and Antimony-free "Green" products are defined as those which contain <900ppm bromine, <900ppm chlorine (<1500ppm total Br + Cl) and <1000ppm antimony compounds.
 5. Automotive products are AEC-Q101 qualified and are PPAP capable. Automotive, AEC-Q101 and standard products are electrically and thermally the same, except where specified. For more information, please refer to http://www.diodes.com/quality/product_compliance_definitions/.
 6. For packaging details, go to our website at <http://www.diodes.com/products/packages.html>.

Marking Information

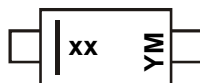

xx = Product Type Marking Code
(See Electrical Characteristics Table)
YM = Date Code Marking
Y = Year (ex: D = 2016)
M = Month (ex: 9 = September)

Date Code Key

Year	2003	2004	...	2012	2013	2014	2015	2016	2017	2018	2019	2020
Code	P	R	...	Z	A	B	C	D	E	F	G	H
Month	Jan	Feb	Mar	Apr	May	Jun	Jul	Aug	Sep	Oct	Nov	Dec
Code	1	2	3	4	5	6	7	8	9	O	N	D

Maximum Ratings (@T_A = +25°C, unless otherwise specified.)

Characteristic	Symbol	Value	Unit
Forward Voltage @ I _F = 10mA	V _F	0.9	V

Thermal Characteristics

Characteristic	Symbol	Value	Unit
Power Dissipation (Note 7) @T _L = +75°C	P _D	500	mW
Power Dissipation (Note 8) @T _A = +25°C	P _D	410	mW
Power Dissipation (Note 9) @T _A = +25°C	P _D	310	mW
Thermal Resistance, Junction to Ambient Air (Note 8)	R _{θJA}	305	°C/W
Thermal Resistance, Junction to Ambient Air (Note 9)	R _{θJA}	403	°C/W
Operating and Storage Temperature Range	T _J , T _{STG}	-65 to +150	°C

Electrical Characteristics (@T_A = +25°C, unless otherwise specified.)

Type Number	Marking Code	Zener Voltage Range (Note 10)			Maximum Zener Impedance f = 1kHz			Maximum Reverse Current (Note 10)	
		V _Z @ I _{ZT}		I _{ZT}	Z _{ZT} @ I _{ZT}	Z _{ZK} @ I _{ZK}	I _{ZK}	I _R	@ V _R
		Min (V)	Max (V)	mA	Ω		mA	μA	V
DDZ5V1B	KM	4.94	5.20	20	17	480	1	5	1.5
DDZ5V6B	KN	5.45	5.73	20	11	400	1	0.5	2.5
DDZ6V2B	KO	5.96	6.27	20	7	150	1	0.5	4.0
DDZ6V8B	KP	6.49	6.83	20	5	150	0.5	0.1	5.0
DDZ6V8C	YP	6.66	7.01	20	5	150	0.5	0.1	5.0
DDZ7V5B	KQ	7.07	7.45	20	6	120	0.5	0.1	6.0
DDZ7V5C	YQ	7.29	7.67	20	6	120	0.5	0.1	6.0
DDZ8V2B	KR	7.78	8.19	20	8	120	0.5	0.1	6.5
DDZ8V2C	YR	8.03	8.45	20	8	120	0.5	0.1	6.5
DDZ9V1B	KS	8.57	9.01	20	8	120	0.5	0.1	7.0
DDZ9V1C	YS	8.83	9.30	20	8	120	0.5	0.1	7.0
DDZ10B	KT	9.41	9.90	20	8	120	0.5	0.1	8.0
DDZ10C	YT	9.70	10.20	20	8	120	0.5	0.1	8.0
DDZ11B	KU	10.50	11.05	10	10	120	0.5	0.1	8.4
DDZ11C	YU	10.82	11.38	10	10	120	0.5	0.1	8.4
DDZ12B	KV	11.44	12.03	10	12	110	0.5	0.1	9.1
DDZ12C	YV	11.74	12.35	10	12	110	0.5	0.1	9.1
DDZ13B	KW	12.55	13.21	10	14	110	0.5	0.1	10.0
DDZ14	GX	13.65	14.35	10	16	110	0.5	0.05	11.0
DDZ14B	KX	13.89	14.62	10	16	110	0.5	0.05	11.0
DDZ15	GY	14.80	15.57	10	18	150	0.5	0.05	12.0
DDZ16B	KY	15.25	16.04	10	18	150	0.5	0.05	12.0
DDZ16	YY	15.69	16.51	10	18	150	0.5	0.05	12.0
DDZ17	KZ	16.82	17.70	10	23	150	0.5	0.05	14.0
DDZ18C	YZ	17.42	18.33	10	23	150	0.5	0.05	14.0
DDZ19	ZJ	18.63	19.59	10	28	200	0.5	0.05	15.0
DDZ20C	PJ	19.23	20.22	10	28	200	0.5	0.05	15.0
DDZ21	ZK	20.64	21.71	5	30	200	0.5	0.05	17.0
DDZ22D	2K	21.52	22.63	5	30	200	0.5	0.05	17.0
DDZ23	ZL	22.61	23.77	5	35	200	0.5	0.05	19.0
DDZ24C	PL	23.12	24.31	5	35	200	0.5	0.05	19.0
DDZ26	ZM	24.97	26.26	5	45	250	0.5	0.05	21.0
DDZ27D	2M	26.29	27.64	5	45	250	0.5	0.05	21.0
DDZ28	ZN	27.70	29.13	5	55	250	0.5	0.05	23.0
DDZ30D	2N	29.02	30.51	5	55	250	0.5	0.05	23.0
DDZ31	ZO	30.32	31.88	5	65	250	0.5	0.05	25.0
DDZ33	RP	32.14	33.79	5	75	250	0.5	0.05	27.0
DDZ34	ZP	32.79	34.49	5	75	250	0.5	0.05	27.0
DDZ36	ZQ	35.36	37.19	5	85	250	0.5	0.05	30.0
DDZ39F	5Q	38.02	39.98	5	85	250	0.5	0.05	30.0
DDZ43	ZR	42.14	43.86	5	90	—	—	0.05	33.0

- Notes:
- R_{θJL} = 132°C/W
 - Device mounted on Alumina ceramic PC board, single-sided, 14mm x 14mm x 1.0mm, 2oz copper traces, with copper pad area 40mm².
 - Device mounted on FR-4 PC board, single-sided, 25mm x 25mm x 1.6mm, 2oz copper traces with 1x minimum recommended pad layout.
 - Short duration pulse test used to minimize self-heating effect.

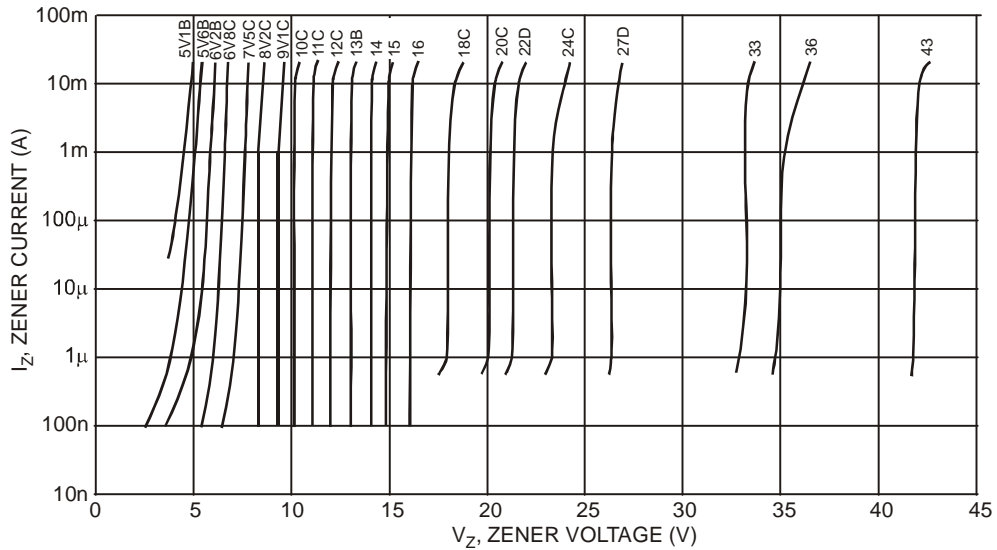
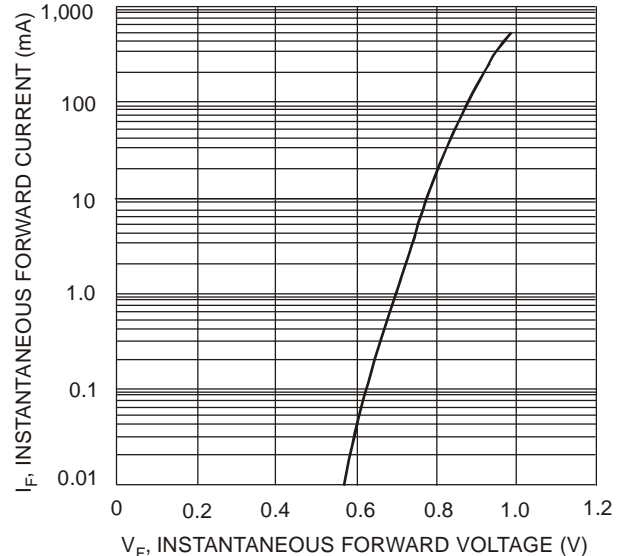
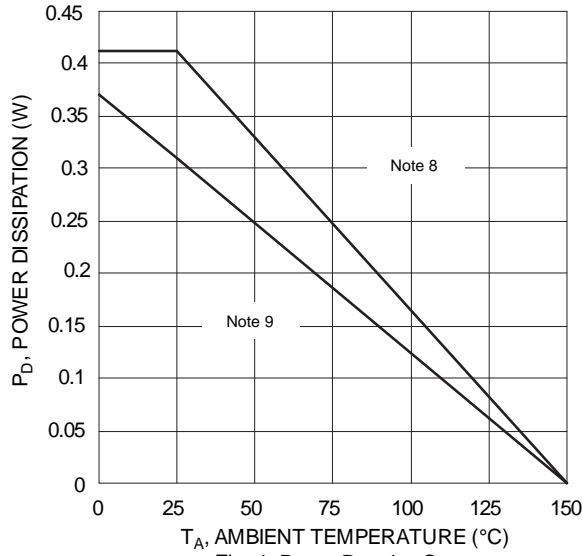

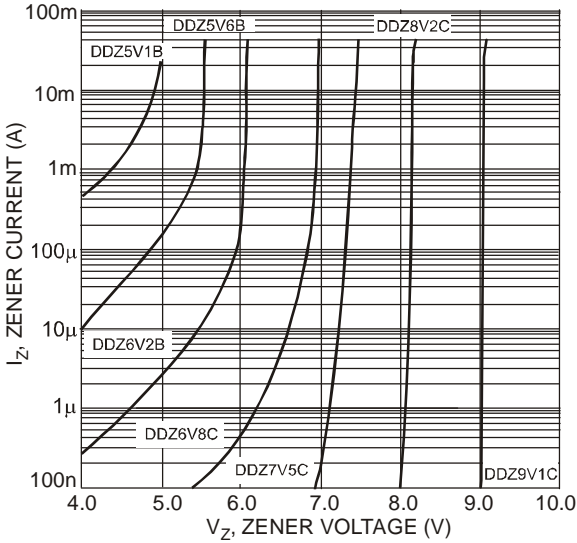

Fig. 4 Typical Zener Breakdown Characteristics, DDZ5V1B - DDZ9V1C

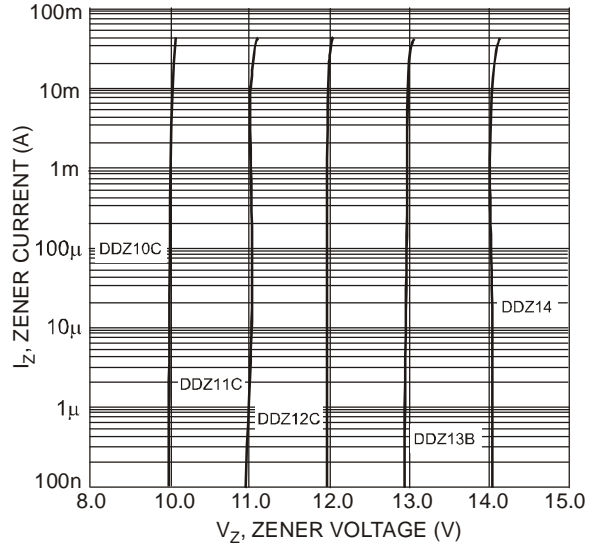

Fig. 5 Typical Zener Breakdown Characteristics, DDZ10C - DDZ14

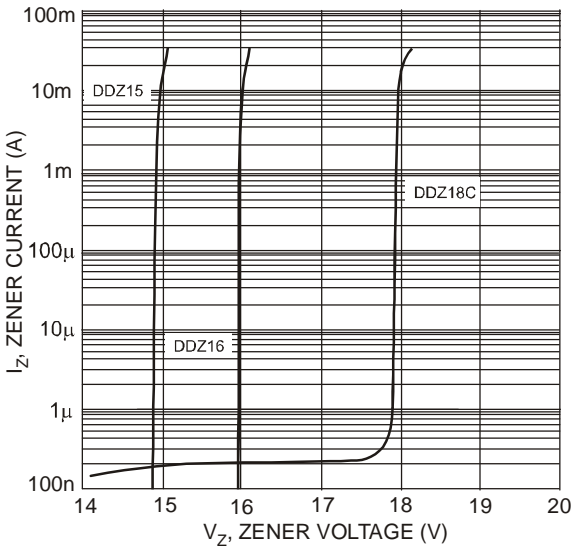

Fig. 6 Typical Zener Breakdown Characteristics, DDZ15 - DDZ18C

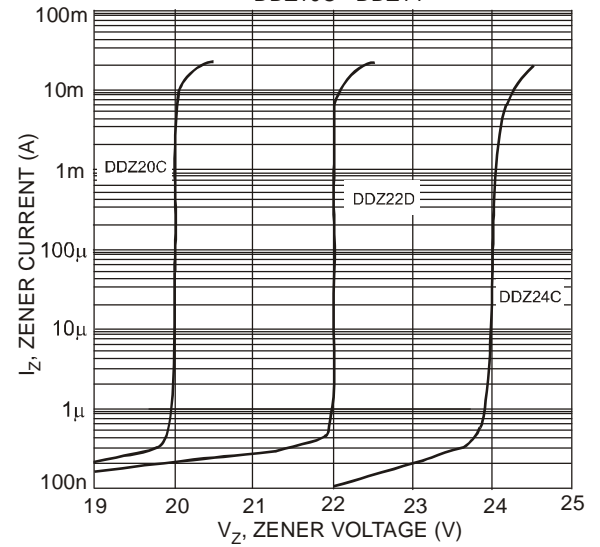

Fig. 7 Typical Zener Breakdown Characteristics, DDZ20C - DDZ24C

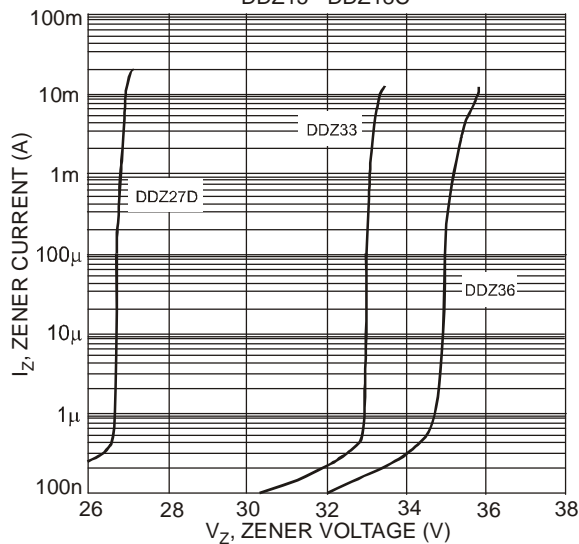

Fig. 8 Typical Zener Breakdown Characteristics, DDZ27D - DDZ36

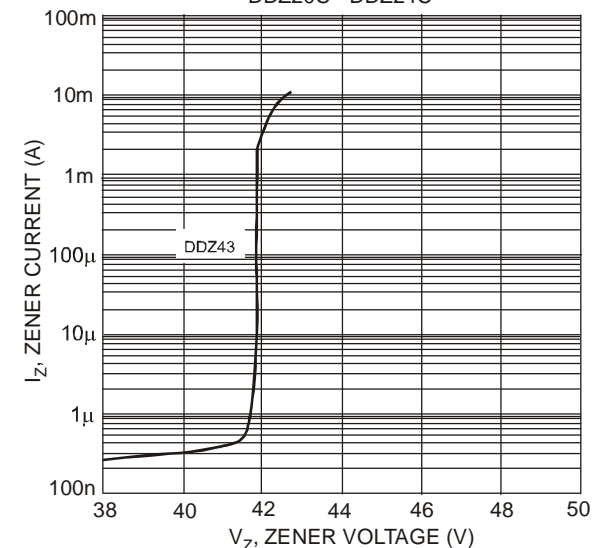

Fig. 9 Typical Zener Breakdown Characteristics, DDZ43

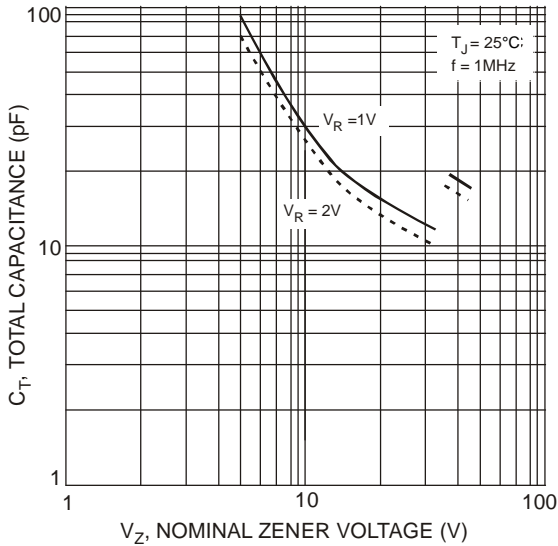

Fig. 10 Typical Total Capacitance vs. Nominal Zener Voltage

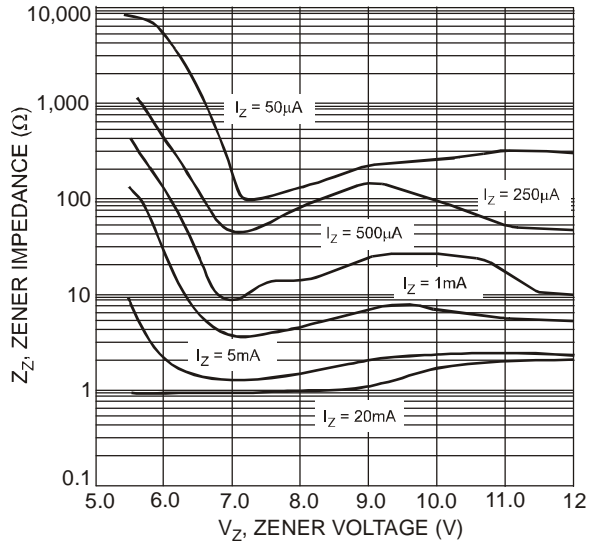

Fig. 11 Typical Zener Impedance Characteristics, DDZ5V6B - DDZ12C

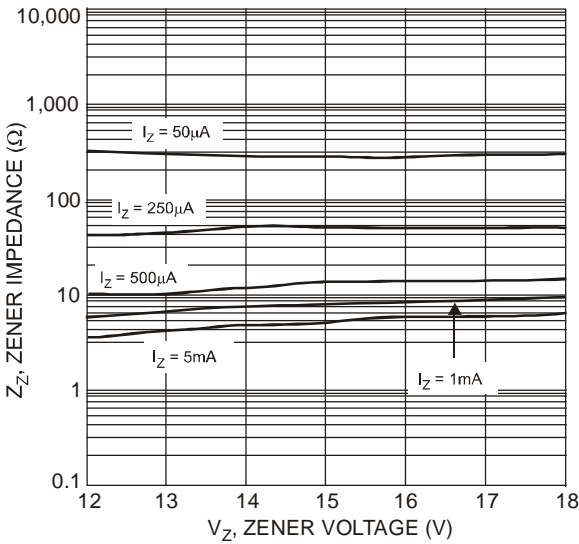

Fig. 12 Typical Zener Impedance Characteristics, DDZ12C - DDZ18C

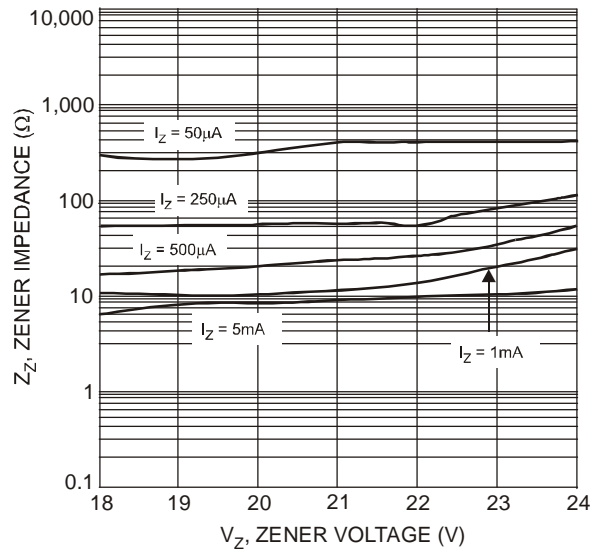

Fig. 13 Typical Zener Impedance Characteristics, DDZ18C - DDZ24C

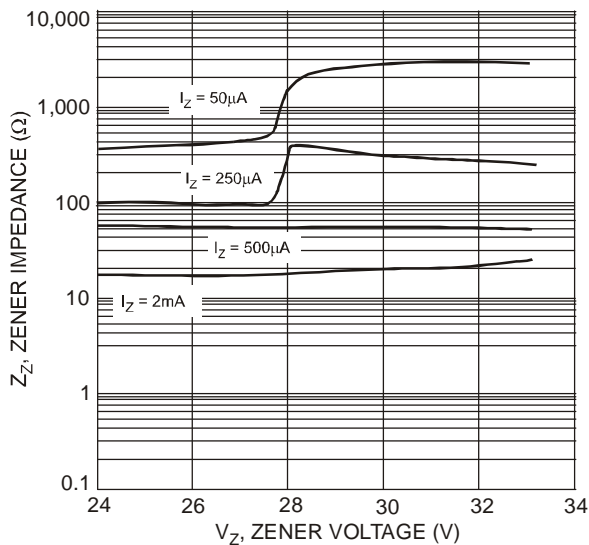

Fig. 14 Typical Zener Impedance Characteristics, DDZ24C - DDZ33

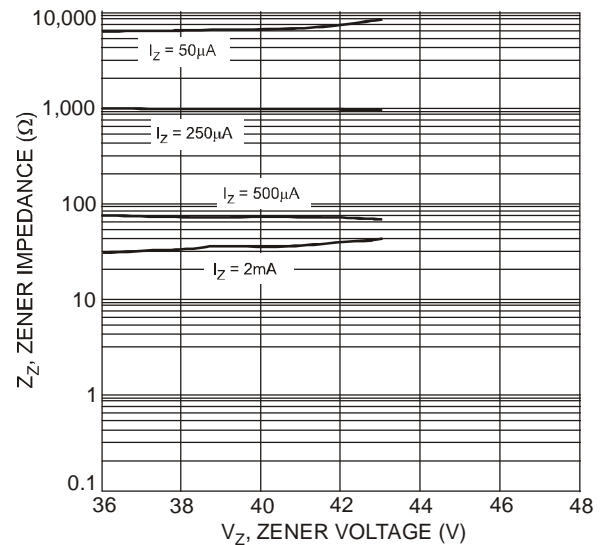

Fig. 15 Typical Zener Impedance Characteristics, DDZ36 - DDZ43

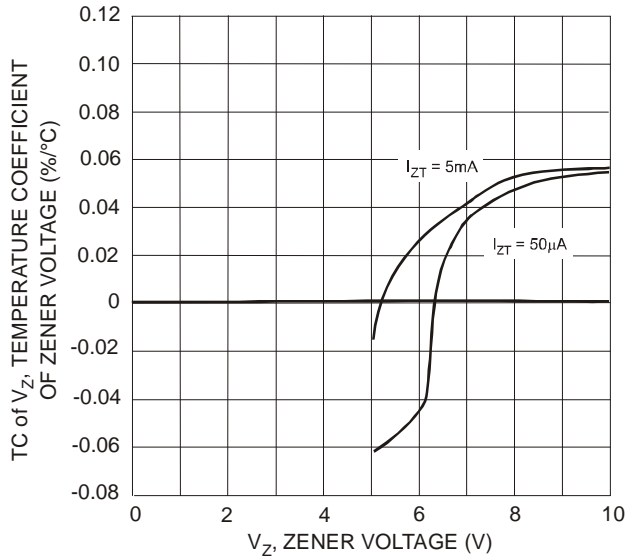

Fig. 16 Typical Temperature Coefficient of Zener Voltage vs. Zener Voltage, DDZ5V1B-DDZ10C

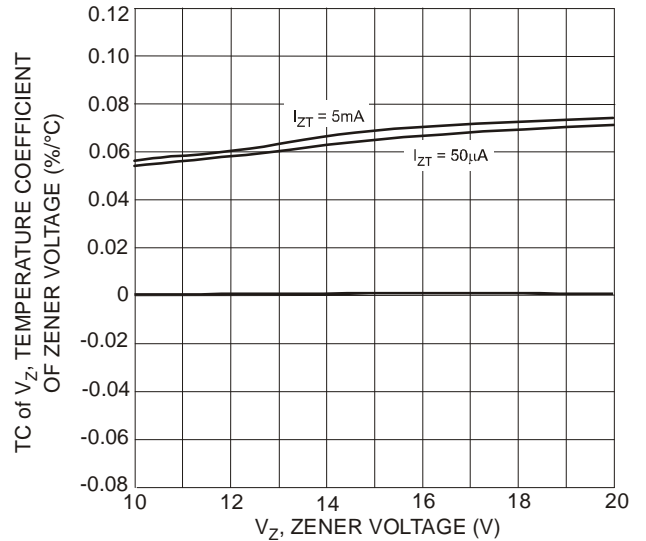

Fig. 17 Typical Temperature Coefficient of Zener Voltage vs. Zener Voltage, DDZ10C-DDZ20C

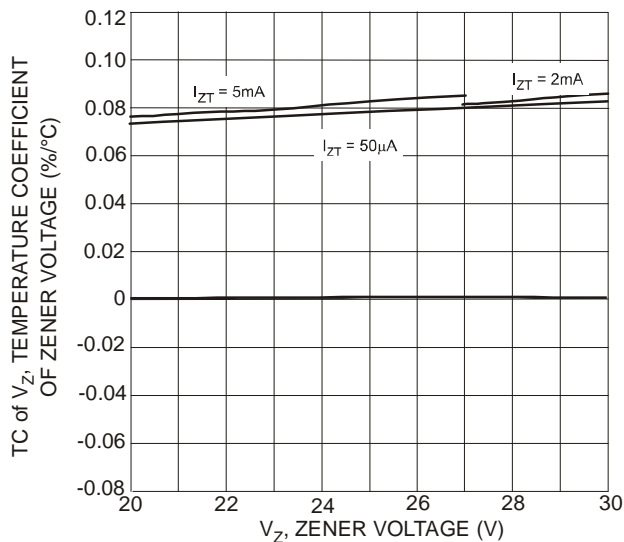

Fig. 18 Typical Temperature Coefficient of Zener Voltage vs. Zener Voltage, DDZ20C-DDZ30D

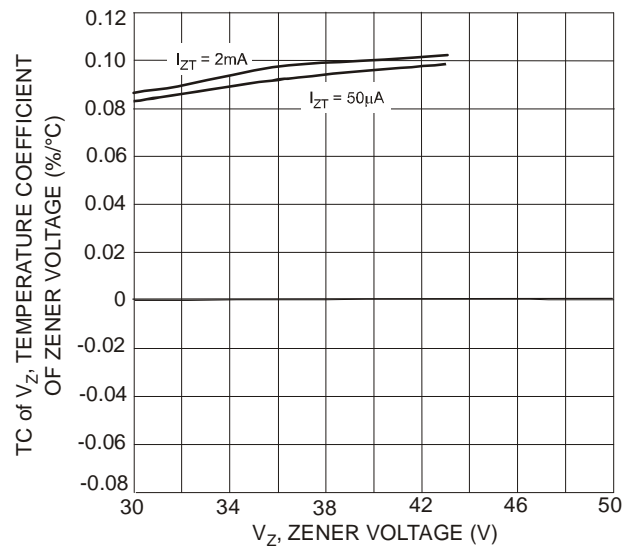
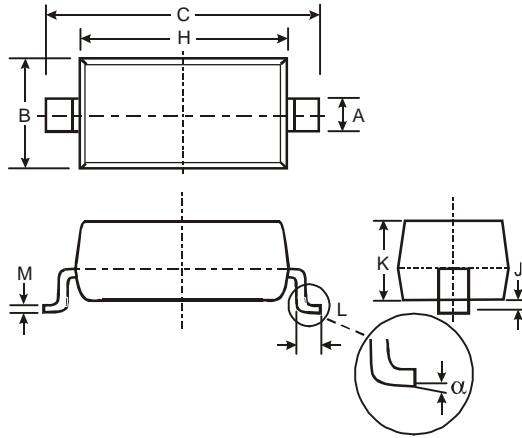

Fig. 19 Typical Temperature Coefficient of Zener Voltage vs. Zener Voltage, DDZ30D-DDZ43

Package Outline Dimensions

Please see <http://www.diodes.com/package-outlines.html> for the latest version.

SOD123



SOD123		
Dim	Min	Max
A	0.55 Typ	
B	1.40	1.70
C	3.55	3.85
H	2.55	2.85
J	0.00	0.10
K	1.00	1.35
L	0.25	0.40
M	0.10	0.15
α	0	8°
All Dimensions in mm		

Suggested Pad Layout

Please see <http://www.diodes.com/package-outlines.html> for the latest version.

SOD123

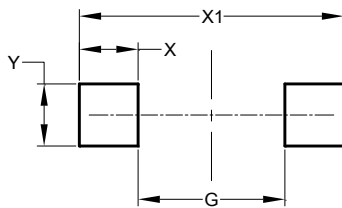

Dimensions	Value (in mm)
G	2.250
X	0.900
X1	4.050
Y	0.950

IMPORTANT NOTICE

DIODES INCORPORATED MAKES NO WARRANTY OF ANY KIND, EXPRESS OR IMPLIED, WITH REGARDS TO THIS DOCUMENT, INCLUDING, BUT NOT LIMITED TO, THE IMPLIED WARRANTIES OF MERCHANTABILITY AND FITNESS FOR A PARTICULAR PURPOSE (AND THEIR EQUIVALENTS UNDER THE LAWS OF ANY JURISDICTION).

Diodes Incorporated and its subsidiaries reserve the right to make modifications, enhancements, improvements, corrections or other changes without further notice to this document and any product described herein. Diodes Incorporated does not assume any liability arising out of the application or use of this document or any product described herein; neither does Diodes Incorporated convey any license under its patent or trademark rights, nor the rights of others. Any Customer or user of this document or products described herein in such applications shall assume all risks of such use and will agree to hold Diodes Incorporated and all the companies whose products are represented on Diodes Incorporated website, harmless against all damages.

Diodes Incorporated does not warrant or accept any liability whatsoever in respect of any products purchased through unauthorized sales channel. Should Customers purchase or use Diodes Incorporated products for any unintended or unauthorized application, Customers shall indemnify and hold Diodes Incorporated and its representatives harmless against all claims, damages, expenses, and attorney fees arising out of, directly or indirectly, any claim of personal injury or death associated with such unintended or unauthorized application.

Products described herein may be covered by one or more United States, international or foreign patents pending. Product names and markings noted herein may also be covered by one or more United States, international or foreign trademarks.

This document is written in English but may be translated into multiple languages for reference. Only the English version of this document is the final and determinative format released by Diodes Incorporated.

LIFE SUPPORT

Diodes Incorporated products are specifically not authorized for use as critical components in life support devices or systems without the express written approval of the Chief Executive Officer of Diodes Incorporated. As used herein:

A. Life support devices or systems are devices or systems which:

1. are intended to implant into the body, or
2. support or sustain life and whose failure to perform when properly used in accordance with instructions for use provided in the labeling can be reasonably expected to result in significant injury to the user.

B. A critical component is any component in a life support device or system whose failure to perform can be reasonably expected to cause the failure of the life support device or to affect its safety or effectiveness.

Customers represent that they have all necessary expertise in the safety and regulatory ramifications of their life support devices or systems, and acknowledge and agree that they are solely responsible for all legal, regulatory and safety-related requirements concerning their products and any use of Diodes Incorporated products in such safety-critical, life support devices or systems, notwithstanding any devices- or systems-related information or support that may be provided by Diodes Incorporated. Further, Customers must fully indemnify Diodes Incorporated and its representatives against any damages arising out of the use of Diodes Incorporated products in such safety-critical, life support devices or systems.

Copyright © 2016, Diodes Incorporated

www.diodes.com

Mouser Electronics

Authorized Distributor

Click to View Pricing, Inventory, Delivery & Lifecycle Information:

Diodes Incorporated:

[DDZ11CQ-7](#) [DDZ18CQ-7](#) [DDZ12BQ-7](#) [DDZ8V2CQ-7](#) [DDZ12CQ-7](#) [DDZ20CQ-7](#) [DDZ6V8CQ-7](#) [DDZ8V2BQ-7](#)
[DDZ6V8BQ-7](#) [DDZ9V1CQ-7](#) [DDZ6V2BQ-7](#) [DDZ5V6BQ-7](#) [DDZ7V5BQ-7](#) [DDZ7V5CQ-7](#) [DDZ9V1BQ-7](#) [DDZ5V1BQ-7](#)