

# 12mm Rotary Encoder

## Type DP12 Series

### Type DP12 Series



12mm Rotary incremental encoder for use in electronic equipment. Can be supplied with or without switch with customisation to standard options.

### Key Features

- 12mm Rotary Encoder
- Incremental Type
- Push on Switch Option
- Various Shaft Lengths
- Pulse Options
- Detent Options

### Characteristics - Electrical

<b>Pulses:</b>	12 & 24
<b>Contact Rating:</b>	0.5mA 5VDC
<b>Dielectric Strength:</b>	300VAC / 1mA, 1 minute
<b>Insulation Resistance (min):</b>	100M ohms at 250VAC
<b>Operating Speed (RPM):</b>	60 RPM
<b>Switch Power Rating (where fitted):</b>	5VDC, 10mA (1mA Min)
<b>Switch Contact Resistance:</b>	100m ohm Max
<b>Electrical Travel:</b>	Continuous
<b>Rotational Noise:</b>	t2 = 2.0 ms max (see below)
<b>Chattering:</b>	t1 & t3 = 3.0 ms max (see below)

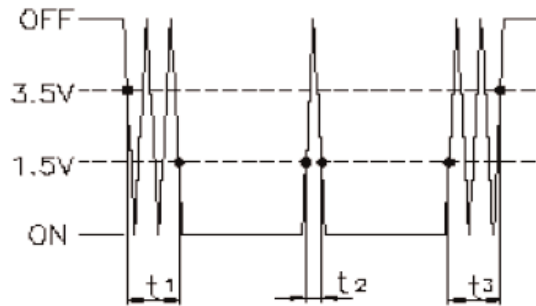

Code Off area V = 3.5V or more. Code on area V=1.5V or less

### Characteristics - Mechanical

<b>Total Mechanical Travel:</b>	Continuous
<b>Detents:</b>	0, 12, 24
<b>Switch Operating Force:</b>	500+/- 100gf
<b>Switch Travel:</b>	0.5mm
<b>Shaft Type:</b>	F – Flatted
<b>Shaft Length (from Mounting Surface):</b>	17.5, 20, 22.5, 25

### Characteristics - Environmental

<b>Operating Temperature</b>	-30 ~ +70 degrees C
<b>Rotational Life</b>	15,000 Cycles

### Output Signal Format

Shaft Rotational Direction	Signal	Format
Clockwise	A (Terminal A-C)	OFF ON
	B (Terminal B-C)	OFF ON
Anticlockwise	A (Terminal A-C)	OFF ON
	B (Terminal B-C)	OFF ON

### Dimensions DP12H

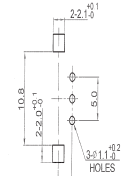
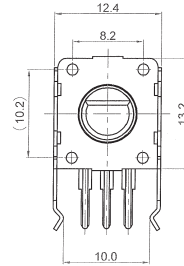
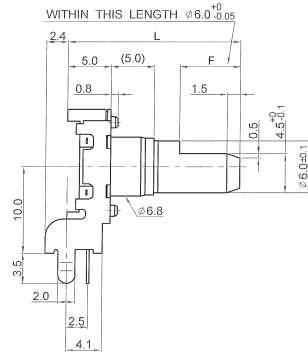

MOUNTING HOLES DETAIL  
VIEWED FROM MOUNTING SIDE  
P.C.B. t=1.6mm

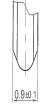

DETAIL OF TERMINALS

### DP12SH

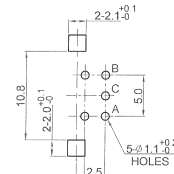
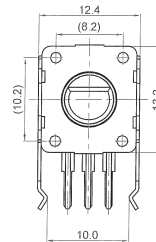
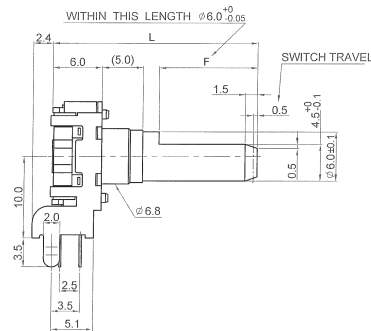

MOUNTING HOLES DETAIL  
VIEWED FROM MOUNTING SIDE  
P.C.B. t=1.6mm



DETAIL OF TERMINALS

### Dimensions DP12V

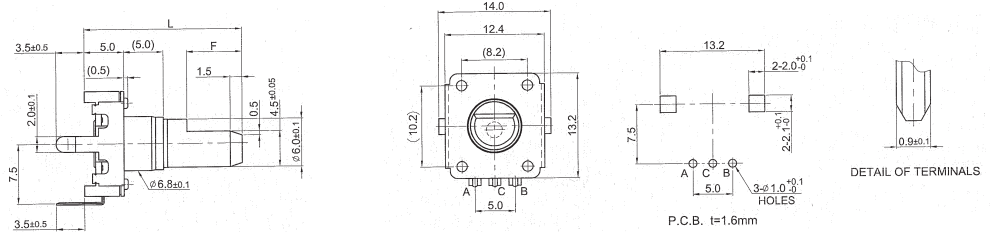

### DP12SV

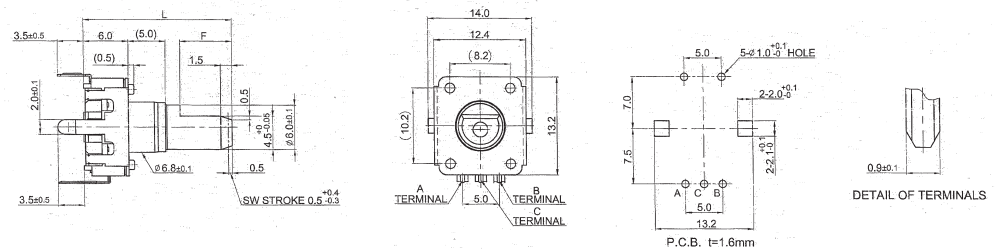

### Shaft Length

L	17.5	20	22.5	25
F	5	7	7	12

### How to Order

DP12	H	N	12	A	20	F
Common Part	Orientation	Detent	Pulses	Bush Details	Shaft Length	Shaft Style
DP12 – No Switch DP12S – With Switch	H - Horizontal V - Vertical	N - None 12 – 12 clicks 24 – 24 Clicks	12 – 12 Pulses 24 – 24 Pulses	A – 5mm V & H Standard	17.5 – 17.5mm 20 – 20mm 22.5 – 22.5mm 25 – 25mm	F - Flatted

# Mouser Electronics

Authorized Distributor

Click to View Pricing, Inventory, Delivery & Lifecycle Information:

[TE Connectivity:](#)

[DP12VN12A22.5F](#)