

FCC
SERIES

FILTER PRODUCTS



Amphenol®

www.amphenol.com

The Company

Amphenol Canada Corp. a subsidiary of Amphenol Corporation, is an international leader in the manufacture of *Filtered Connectors* and *Specialty Interconnect Devices*, and has been pioneering EMI and EMP technologies for more than 40 years.

Located in Toronto, Canada, our ISO 9001 certified facility employs approximately 400 people. Our activities are dedicated to the design, development and manufacture of EMI/EMP filter

connector products which are used in Commercial, Industrial, Communications, Military and Aerospace applications worldwide. Our expertise in understanding and supporting our customers' filter interconnect needs has earned Amphenol Canada a reputation of quality and excellence among the world's leading users of electronic components.

What is a Filtered Connector?

A **filtered connector** is the combination of filter elements in a connector, forming one neat, compact interconnect device that can filter unwanted EMI. The most popular configuration is when

capacitors are mounted inside the connector between each of the contacts and the connector ground shell.

Benefits

Better EMI Control – With minimized lead inductances and short, direct paths to ground of the filter, performance will typically out perform the same filter components on a P.C.B. by a factor of three to one.

PCB Space Savings – Incorporating filter elements into the connector, enables simplification of the required filter schematic for the necessary performance plus a savings of 2-4 square inches.

Cost Savings – Filter elements, such as inductors and capacitors, must no longer be purchased, stocked, assembled or tested. Fewer components means greater reliability at lower cost.

Easy EMI/RFI Upgrade – These compact filtered connectors fit standard non-filtered connector footprints. For improved EMC performance, simply replace the existing connector with a filtered connector.

EMC Compliance & Immunity – EMI that is generated from the electronic device, radiated or conducted, will be re-directed to chassis ground through the connector shell. This same device will also protect the system from external EMI/RFI noise (such as radio transmitters, ESD, or natural phenomena such as lightning) in the same way.

Choosing the Right Capacitance for Your Filter Connector

- (1) Determine the highest frequency that the filter connector needs to pass unaffected.
- (2) Which frequencies are causing trouble, either with emissions or with immunity to interference?

- (3) Scan the Insertion Loss charts on page 2 to select a filter which provides little or no insertion loss (filtering) at the frequency determined from step 1, yet gives the greatest possible insertion loss at the frequencies determined in step 2.

Nominal Insertion Loss values described in this catalog are based on the Mil-STD-220 test method - a 50 ohm balanced load and source impedance. Different systems will differ from this and

hence, the filter connector may perform differently. The final decision will be determined from actual EMI/RFI testing of the equipment in question.

D-Sub Series



FCC17 Series	Electrical Data, Insertion Loss Performance	2
	Mechanical and Environmental Data	3
	Filtered Stacked D-Sub Connectors	4
	Filtered D-Sub Connectors: How To Order	5-10
	Filtered Combo D-Sub Connectors	11-16

Micro-Ribbon Series



FCC57 Series	Electrical Data, Insertion Loss Performance	2
	Mechanical and Environmental Data	3
	Filtered Micro-Ribbon Connectors: How To Order	17-22

RF Series



456 Series	Capacitively Decoupled RF Connectors	23-35
-------------------	---------------------------------------------	--------------

Modular Jacks

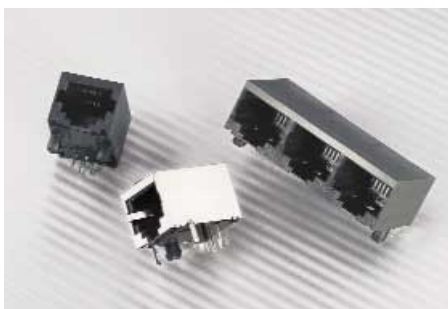

FRJ/FRJA Series	Filtered & Shielded -
	See Modular Jack Catalogue

FCC17 & FCC57 Series

ELECTRICAL DATA

Contact Resistance: 15 milliohms maximum per MIL-STD-1344 Method 3002
Insulation Resistance: 3000 megohms minimum per MIL-STD-1344 Method 3003.1
Current Rating: 5 Amps DC maximum
 2 Amps RF filtering maximum
FCC17 Combo: 20-40 Amps

Filter Performance:

Filter Capacitance (pF) @25°C, 1 kHz, 1.0 VRMS	50	180	330	470	820	1000	1200	2200	5600	47000
	± 15%	± 15%	± 15%	± 15%	± 15%	± 15%	± 15%	± 15%	± 20%	± 20%
Dielectric Material: NPO or X7R										
Insertion Loss (dB) (per MIL-STD-220 @ 25°C)										
.5 MHz									3	15
1 MHz								1	5	20
5 MHz				1	1	1	1	5	11	27
10 MHz			1	2	3	3	4	8	16	32
50 MHz		4	7	11	16	16	17	23	32	32
100 MHz	2	12	15	22	30	30	30	32	32	32
200 MHz	12	27	28	30	32	32	32	32	32	32
1000 MHz	32	32	32	32	32	32	32	32	32	32
Working Voltage (VDC)	300	300	300	300	200	200	200	200	200	50
DWV (VDC) *	600	600	600	600	600	600	600	600	600	150

NOTE: A larger range of capacitors available - consult factory.

* FCC57 connectors can be specified to meet the requirements of FCC Docket 20780, Part 68, Subpart F (1000 VAC for one minute. Consult factory for details).

FCC17 and FCC57 connectors can withstand a transient voltage spike of 700 V with a rise time of 1 µsec (500 V for 47000 pF).

FCC17 and FCC57 connectors can be specified to meet higher DWV and transient voltage requirement (consult factory).

Typical Insertion Loss Performance (dB) (Per MIL-STD-220, no load)

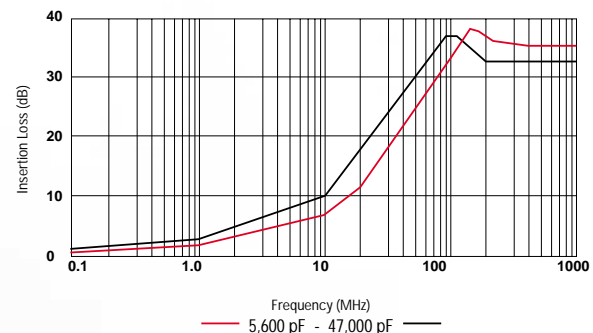
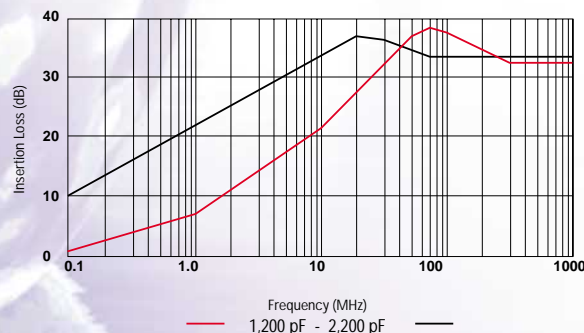
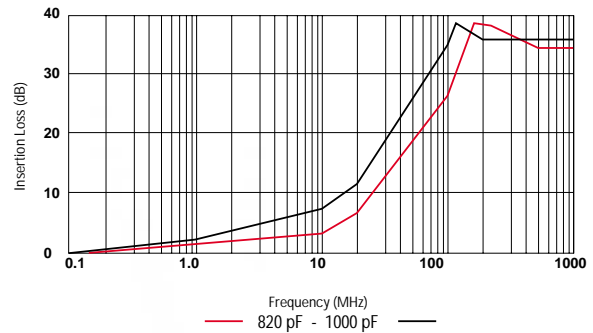
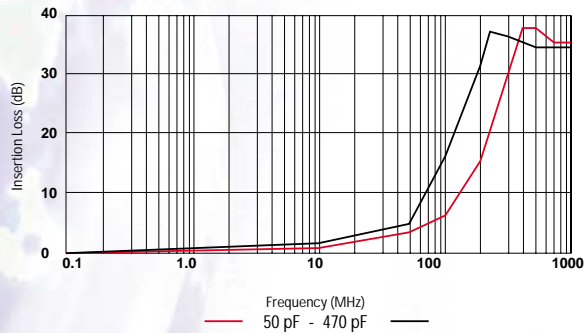

FCC17 & FCC57 Series

MECHANICAL DATA

FCC17 Series Construction

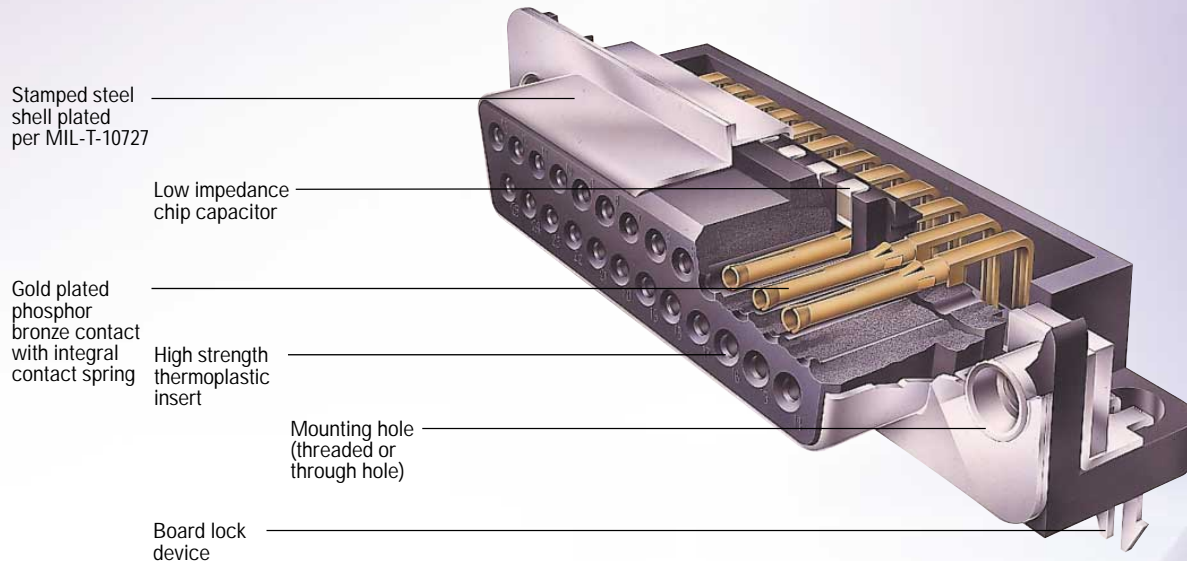

FCC17 & FCC57 Mechanical & Environmental Data

MATERIALS

FCC17

Shell Stamped Steel;
Tin Plated

Contacts Phosphor Bronze;
15 μ inches
[0.38 microns]
Au over Ni
Optional 50 μ inches
[1.27 microns]
Au available

FCC17 Combo

Copper Alloy
30 μ inches
[0.76 microns]
Au over Ni

Inserts High Strength
Thermoplastic.
Complies with UL
flammability
requirements of
94V-0 per UL-STD-94.

FCC57

Shell Stamped Steel,
Zinc or Aluminum
Diecast; Tin Plated

Contacts Phosphor Bronze;
30 μ inches
[0.76 microns]
Au over Ni
Optional 50 μ inches
[1.27 microns]
Au available

Inserts High Strength
Thermoplastic.
Complies with UL
flammability
requirements of
94V-0 per UL-STD-94.

ENVIRONMENTAL

FCC17 & FCC57

OPERATING TEMPERATURE • -40°C to +85°C

TEMPERATURE CYCLING • To MIL-STD-1344,
Method 1003, Test Cond. A

HUMIDITY • To MIL-STD-1344,
Method 1002, Type I,
Test Condition C

VIBRATION • To MIL-STD-1344,
Method 2005, Test Cond. III

DURABILITY • 200 Cycles Minimum,
to MIL-STD-1344,
Method 2016

UL File # E135615
CSA File # LR68598

FCC17 Series

FILTERED STACKED D-SUB CONNECTORS

Ordering Information – Stacked D-Sub

FCC17 – 2 BP BS – 4 5 5 X

FCC17	SERIES DESIGNATION	
2	VERTICAL MOUNTING DIMENSION BETWEEN CONNECTORS 1 = .625" [15.88 mm] 2 = .750" [19.05 mm]	
BP	UPPER CONNECTOR CONFIGURATION (Size and Style) EP: 9 pin BP: 25 pin ES: 9 socket BS: 25 socket AP: 15 pin CP: 37 pin AS: 15 socket CS: 37 socket	
BS	LOWER CONNECTOR CONFIGURATION (Size and Style) same as Upper Connector Configuration	
4	MOUNTING 2: .120" [3.05 mm] Diameter Through Hole on Flanges 4: 4-40 Threaded Inserts on Flanges E: 4-40 Hex Jack Sockets (supplied loose)	
	MODIFIER 0: Standard Product x: Special or Custom Versions	X
	LOWER CONNECTOR FILTER CAPACITANCE same as Upper Connector Filter Capacitance Designation	5
	UPPER CONNECTOR FILTER CAPACITANCE	5

D:	50 pF	5:	1,000 pF
0:	180 pF	E:	2,200 pF
F:	330 pF	7:	1,200 pf
1:	470 pF	9:	5,600 pF
4:	820 pF	8:	47,000 pF

* For Additional Mounting Options and Filter Capacitance - Consult Factory

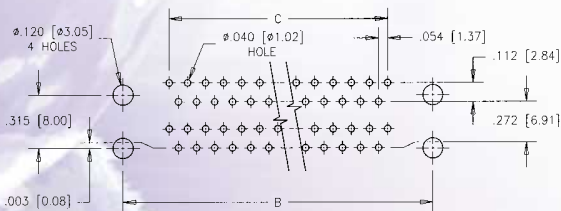
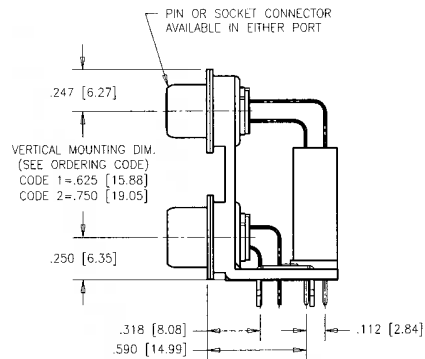
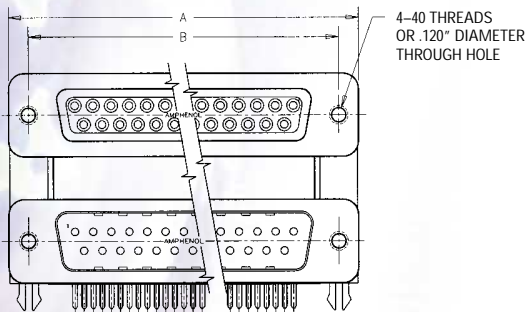

Dimensions

Connector size	A	B	C
9 / 9	1.213 [30.81]	.984 [24.99]	.432 [10.97]
15 / 15	1.541 [39.14]	1.312 [33.32]	.756 [19.20]
25 / 25	2.088 [53.04]	1.852 [47.04]	1.304 [33.12]
37 / 37	2.729 [69.32]	2.500 [63.50]	1.956 [49.68]

Consult factory for alternative arrangements

Specifications

Filter Characteristics: See Page 2
 Electrical Data: See Page 2
 Material and Finishes: See Page 3
 Environmental Data: See Page 3
 UL File # : E135615
 CSA File # : LR68598



These products are protected by U.S. Patent # 4500159

Ordering Information – D-Sub

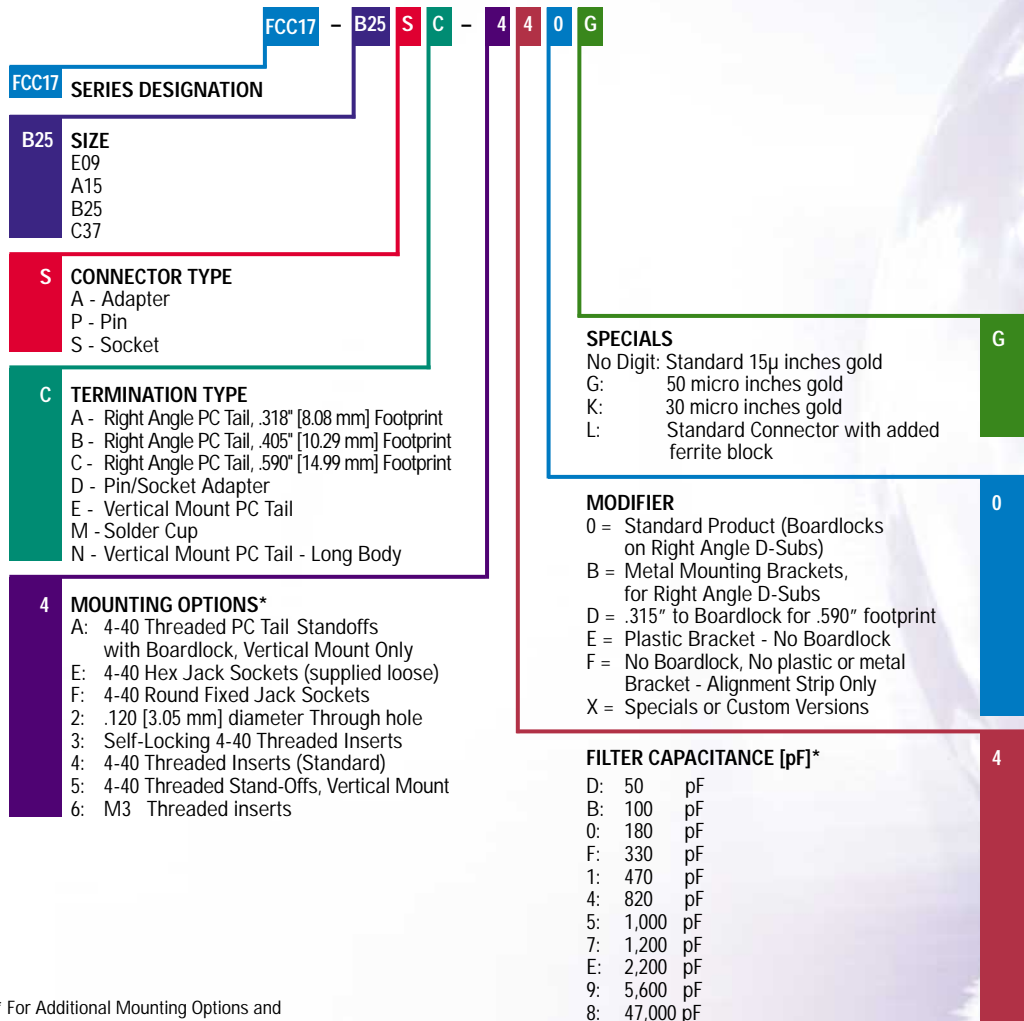

* For Additional Mounting Options and Filter Capacitance - Consult Factory

FCC17 Series

FILTERED D-SUB CONNECTORS

Pin

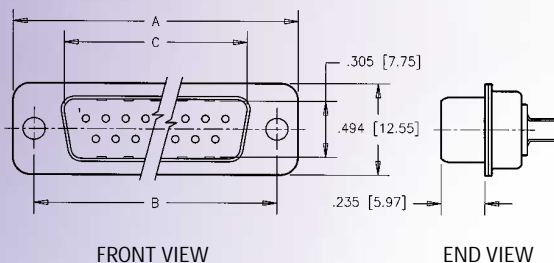

Socket

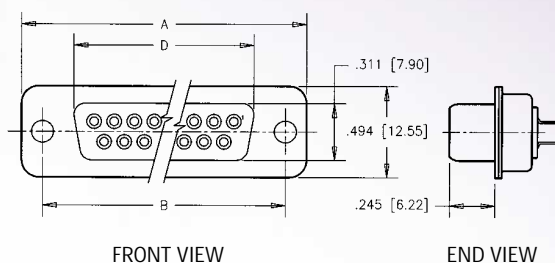

All Dimensions in Inches (mm)

Shell Size	Standard Number of Contacts	A	B	C (for pin connector)	D (for socket connector)
E	9	1.213 [30.81]	.984 [24.99]	.666 [16.92]	.643 [16.33]
A	15	1.541 [39.14]	1.312 [33.32]	.994 [25.25]	.971 [24.66]
B	25	2.088 [53.04]	1.852 [47.04]	1.534 [38.96]	1.511 [38.38]
C	37	2.729 [69.32]	2.500 [63.50]	2.182 [55.42]	2.159 [54.84]

Mounting Dimensions

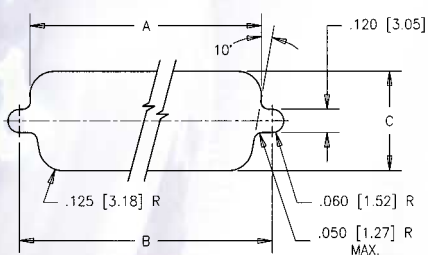

FRONT MOUNTING CUT-OUT

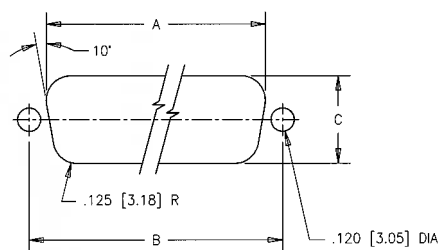

REAR MOUNTING CUT-OUT

Size	Mounting	A	B	C
9	Front	.875 [22.23]	.984 [24.99]	.512 [13.00]
	Rear	.807 [20.50]	.984 [24.99]	.449 [11.40]
15	Front	1.200 [30.48]	1.312 [33.32]	.512 [13.00]
	Rear	1.134 [28.80]	1.312 [33.32]	.449 [11.40]
25	Front	1.744 [44.30]	1.852 [47.04]	.512 [13.00]
	Rear	1.673 [42.49]	1.852 [47.04]	.449 [11.40]
37	Front	2.389 [60.68]	2.500 [63.50]	.512 [13.00]
	Rear	2.326 [59.08]	2.500 [63.50]	.449 [11.40]

FCC17 Series

FILTERED D-SUB CONNECTORS

Vertical Mount

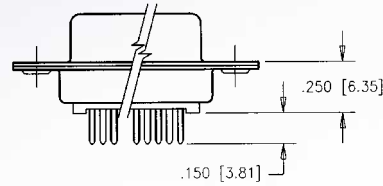

Termination Type E

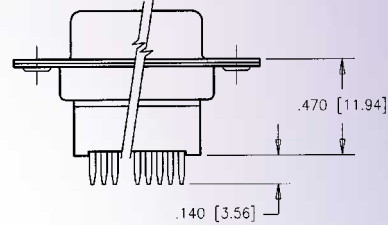

Termination Type N

Right Angle, with Boardlocks & Plastic Mounting Brackets

.318" FOOTPRINT

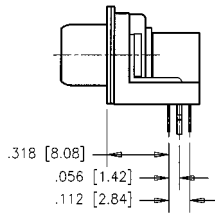

Termination Type A
with Modifier option O

.405" FOOTPRINT

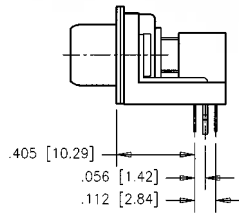

Termination Type B
with Modifier option O

.590" FOOTPRINT

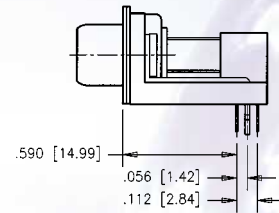

Termination Type C
with Modifier option O

Right Angle, with Metal Mounting Brackets

.318" FOOTPRINT

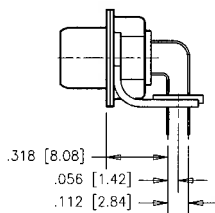

Termination Type A
with Modifier option B

.405" FOOTPRINT

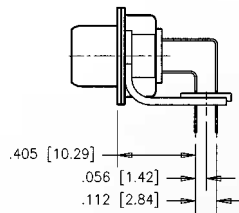

Termination Type B
with Modifier option B

.590" FOOTPRINT

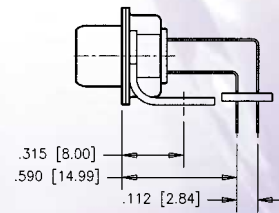

Termination Type C
with Modifier option B

FCC17 Series

FILTERED D-SUB CONNECTORS

Solder Cup Termination

Termination type M

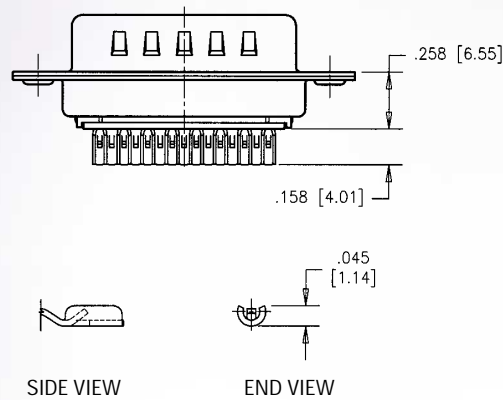

SOLDER CUP DETAIL
(ACCEPTS UP TO 20 AWG WIRE)

Pin-to-Socket Adapter

Termination type D

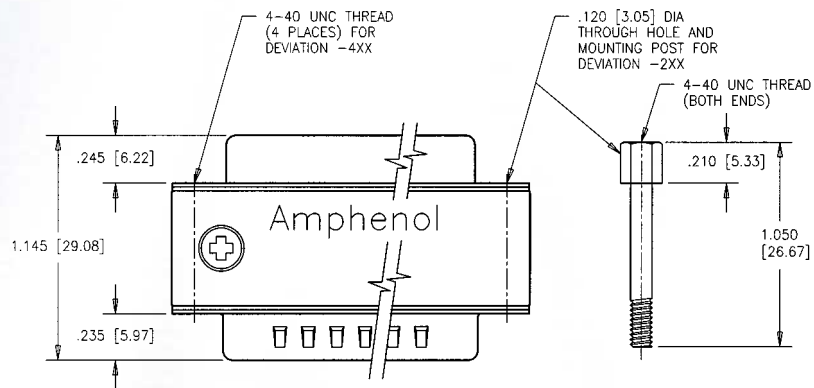

Mounting Options
Through Hole with Mounting Post
4-40 Threaded Inserts

Part No. Example
FCC17-B25AD-2x0
FCC17-B25AD-4x0

x = To complete the P/N, see page 5 to assign Filter Capacitance Code.
For electrical and mechanical specifications, see pages 2 and 3.

FCC17 Series

FILTERED D-SUB CONNECTORS

Mounting Options (on Flange)

Shown for Vertical Mount Connectors. Codes 2, 3, 4, 6, E and F also available on right angle connectors.

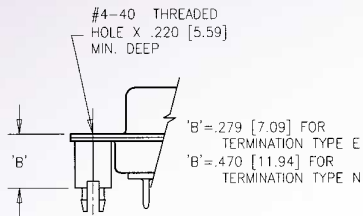

-Axx
4-40 Threaded Standoffs with Boardlocks (Vertical Mount only)
Mounting code A

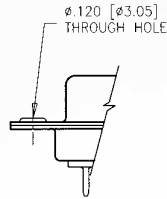

-2xx
.120" (3.05 mm) diameter thru hole
Mounting code 2

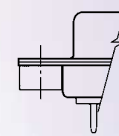

-3xx, 4xx and 6xx
4-40 Threaded Inserts - Self locking
4-40 Threaded inserts (standard)
M3 threaded inserts
Mounting codes 3, 4 and 6

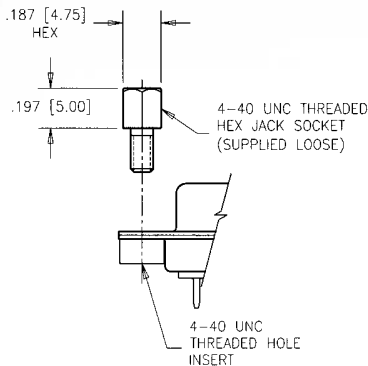

-Exx
4-40 Hex Jack Sockets (supplied loose)
Mounting code E

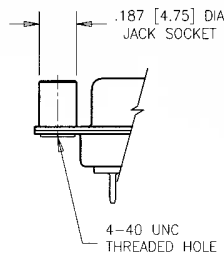

-Fxx
4-40 Round fixed Jack Sockets
Mounting code F

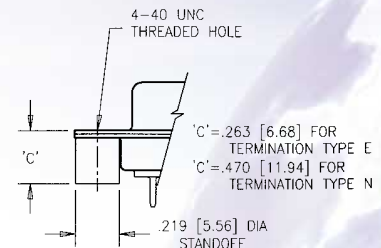

-5xx
4-40 Threaded Standoff (vertical mount only)
Mounting code 5

Bracket Options & Specials

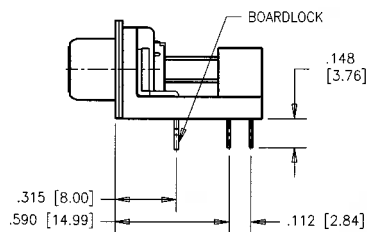

-xxD
.315" to Boardlock
for .590" Footprint only
Modifier option D

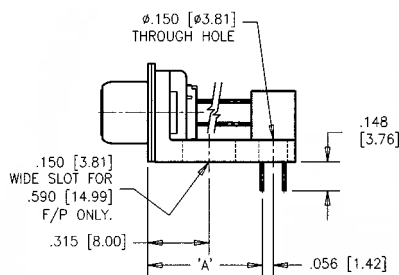

-xxE
Plastic bracket only
Modifier option E

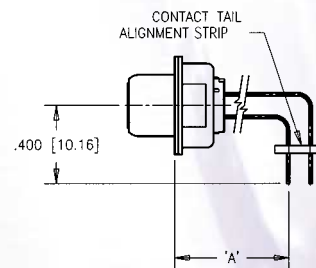

-xxF
Alignment Strip Only
No bracket or boardlocks
Modifier option F

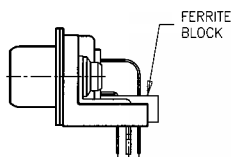

FERRITE
Consult Factory for details

Termination Type	"A" Dimension
A	.318 (8.08)
B	.405 (10.29)
C	.590 (14.99)

FCC17 Series

FILTERED D-SUB CONNECTORS

PCB Layout

9 SIZE

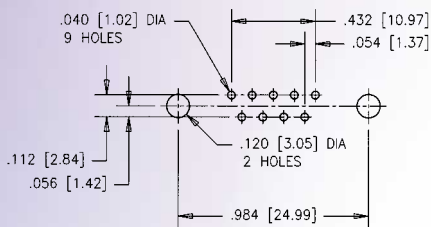

Standard PCB layout

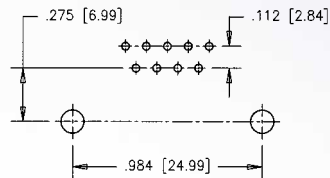

PCB layout for .590° footprint with Modifier Options B or D only

15 SIZE

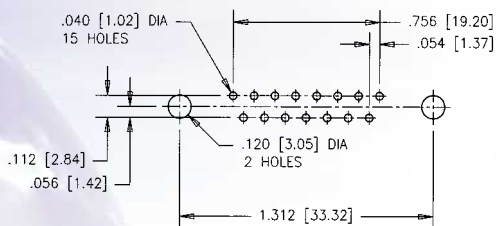

Standard PCB layout

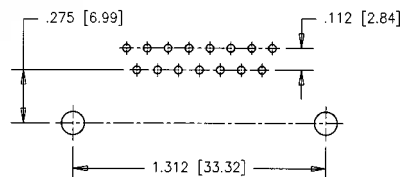

PCB layout for .590° footprint with Modifier Options B or D only

25 SIZE

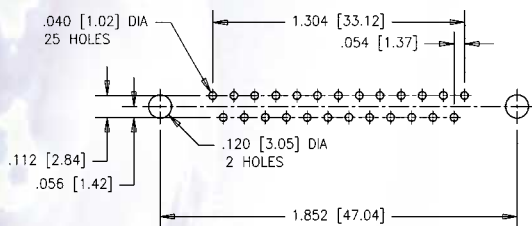

Standard PCB layout

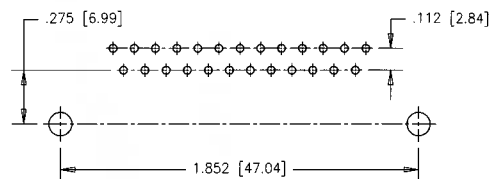

PCB layout for .590° footprint with Modifier Options B or D only

37 SIZE

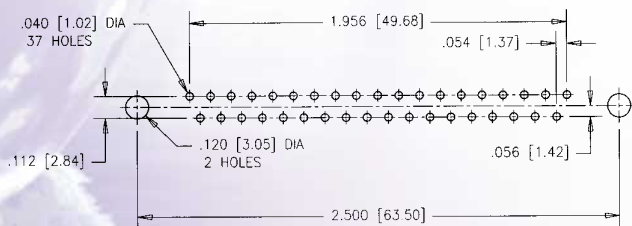

Standard PCB layout

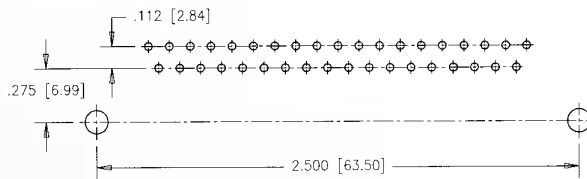

PCB layout for .590° footprint with Modifier Options B or D only

FCC17 Series

COMBO D-SUB FILTER CONNECTORS

Specifications

Filter Characteristics: See Page 2
 Electrical Data: See Page 2
 Material and Finishes: See Page 3
 Environmental Data: See Page 3
 UL File # : E135615
 CSA File # : LR68598



These products are protected by U.S. Patent # 4500159

Ordering Information – Combo D-Sub



* For Additional Mounting Options and Filter Capacitance - Consult Factory

FCC17 Series

COMBO D-SUB FILTER CONNECTORS

Insert Arrangements - Male Front View



Shell Size E
Arrangement 2W2
No. of Signal Contacts 0
No. of Power Contacts 2

Consult factory
for availability

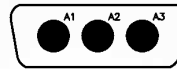

Shell Size A
Arrangement 3W3
No. of Signal Contacts 0
No. of Power Contacts 3

Keyed Version
also available
Consult factory
for availability

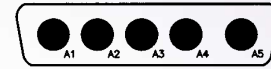

Shell Size B
Arrangement 5W5
No. of Signal Contacts 0
No. of Power Contacts 5

Keyed Version
also available
Consult factory
for availability



Shell Size B
Arrangement 9W4
No. of Signal Contacts 5
No. of Power Contacts 4

Consult factory
for availability

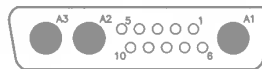

Shell Size B
Arrangement 13W3
No. of Signal Contacts 10
No. of Power Contacts 3

Consult factory
for availability



Shell Size B
Arrangement 17W2
No. of Signal Contacts 15
No. of Power Contacts 2

Consult factory
for availability

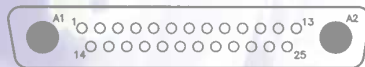

Shell Size C
Arrangement 27W2
No. of Signal Contacts 25
No. of Power Contacts 2

Consult factory
for availability



Shell Size C
Arrangement 8W8
No. of Signal Contacts 0
No. of Power Contacts 8

Consult factory
for availability

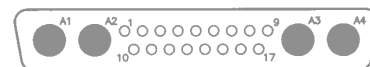

Shell Size C
Arrangement 21WA4
No. of Signal Contacts 17
No. of Power Contacts 4

Consult factory
for availability

Consult Factory for Additional Arrangements and Polarization

FCC17 Series

COMBO D-SUB FILTER CONNECTORS

Pin

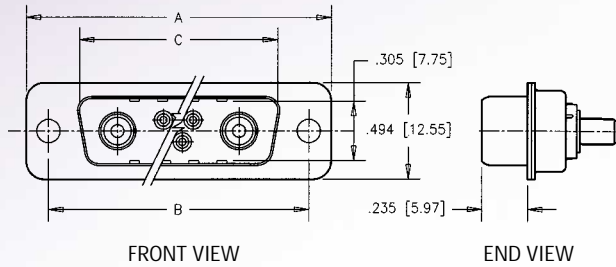

Socket

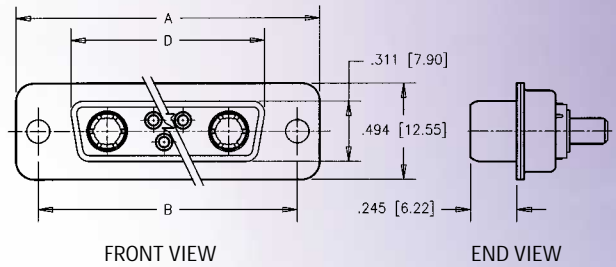

All Dimensions in Inches (mm)

Shell Size	A	B	C (for pin conn. only)	D (for socket conn. only)
E	1.213 [30.81]	.984 [24.99]	.666 [16.92]	.643 [16.33]
A	1.541 [39.14]	1.312 [33.32]	.994 [25.25]	.971 [24.66]
B	2.088 [53.04]	1.852 [47.04]	1.534 [38.96]	1.511 [38.38]
C	2.729 [69.32]	2.500 [63.50]	2.182 [55.42]	2.159 [54.84]

Mounting Dimensions

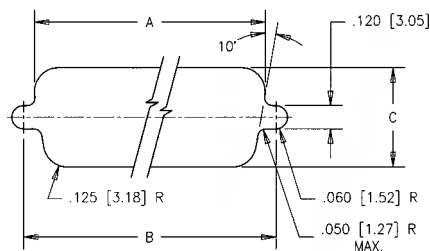

STANDARD CUT-OUT
(FOR FRONT MOUNTING)

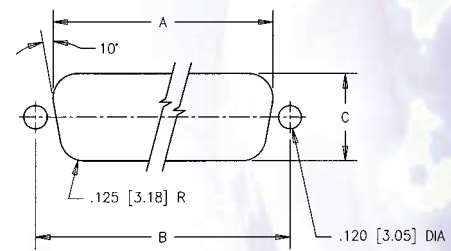

OPTIONAL CUT-OUT
(FOR REAR MOUNTING)

Size	Mounting	A	B	C
E	Front	.875 [22.23]	.984 [24.99]	.512 [13.00]
	Rear	.807 [20.50]	.984 [24.99]	.449 [11.40]
A	Front	1.200 [30.48]	1.312 [33.32]	.512 [13.00]
	Rear	1.134 [28.80]	1.312 [33.32]	.449 [11.40]
B	Front	1.744 [44.30]	1.852 [47.04]	.512 [13.00]
	Rear	1.673 [42.49]	1.852 [47.04]	.449 [11.40]
C	Front	2.389 [60.68]	2.500 [63.50]	.512 [13.00]
	Rear	2.326 [59.08]	2.500 [63.50]	.449 [11.40]

Consult Factory - Shell Size D

FCC17 Series

COMBO D-SUB FILTER CONNECTORS

Straight PCB

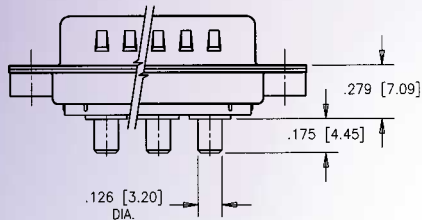

Termination type E

Press Fit

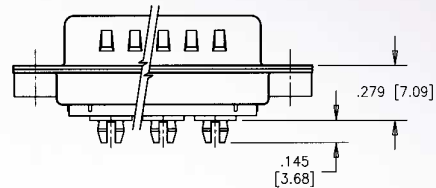

Termination type R

Solder Cup

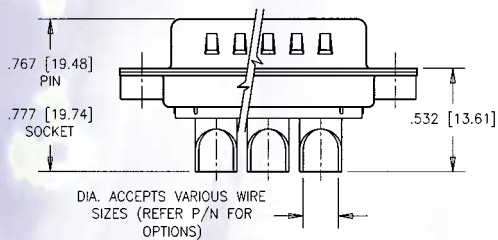

Termination types: K, L, M

Adapter – Pin/Socket

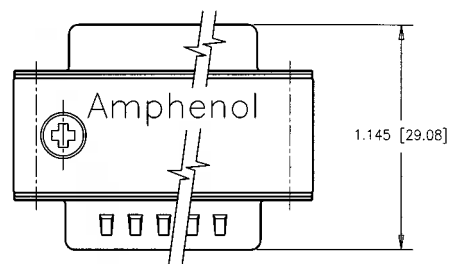

Termination type: D

PCB Layout - Straight PCB & Press Fit

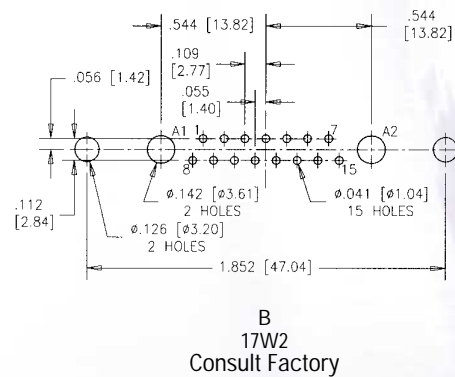
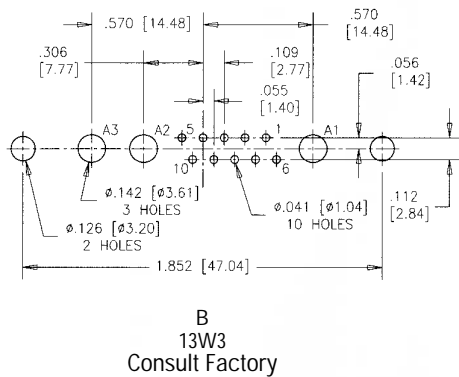
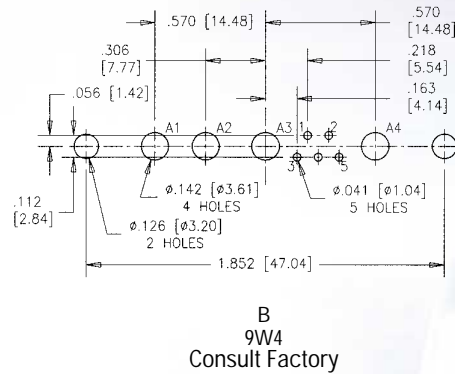
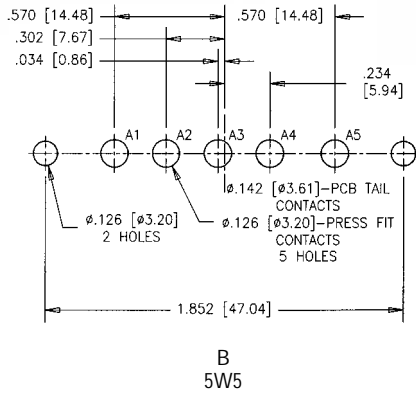
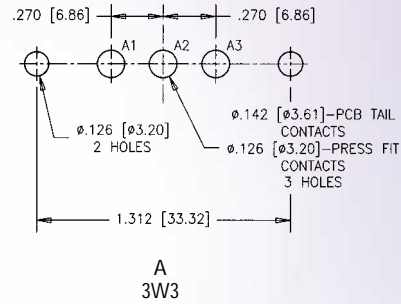
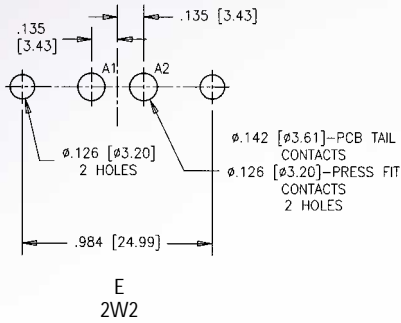

FCC17 Series

COMBO D-SUB FILTER CONNECTORS

PCB Layout - Straight PCB & Press Fit

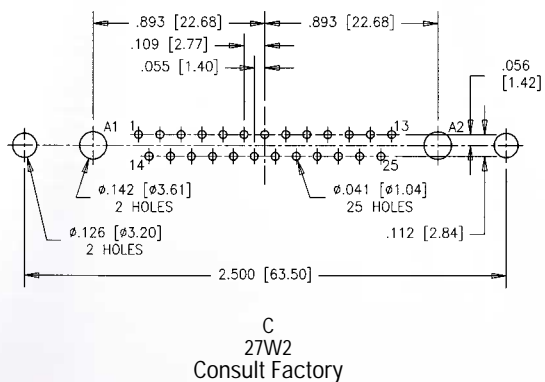
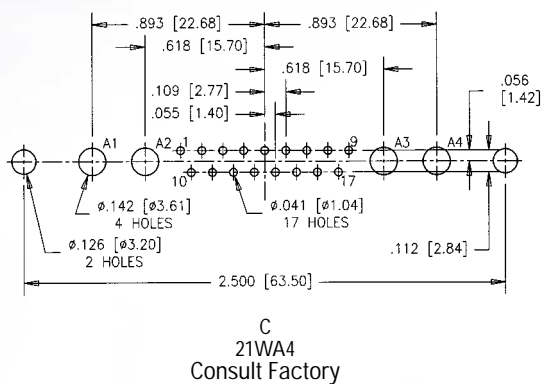
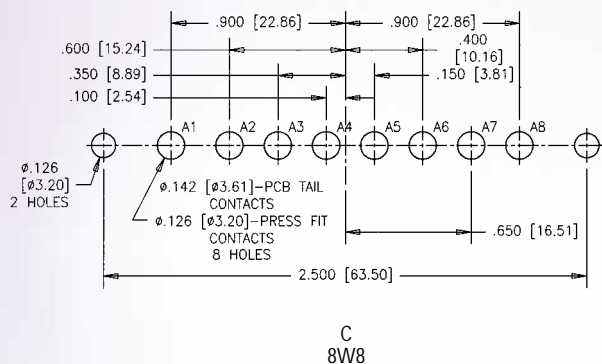

FCC57 Series

FILTERED MICRO-RIBBON CONNECTORS

Specifications

Filter Characteristics: See Page 2
 Electrical Data: See Page 2
 Material and Finishes: See Page 3
 Environmental Data: See Page 3
 UL File # : E135615
 CSA File # : LR68598

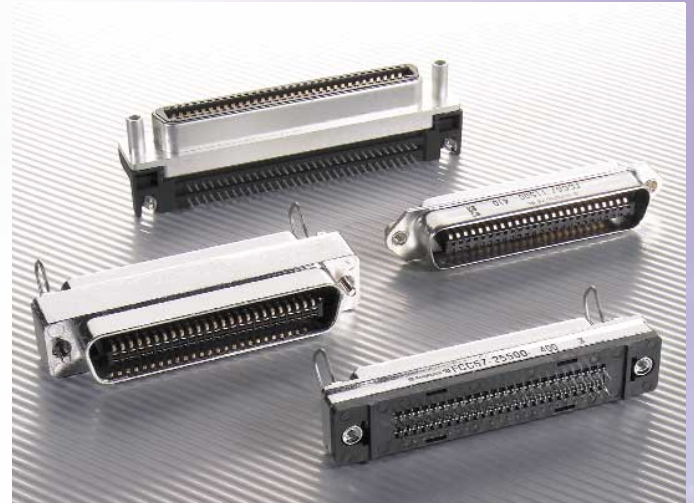

These products are protected by U.S. Patent # 4500159

Ordering Information

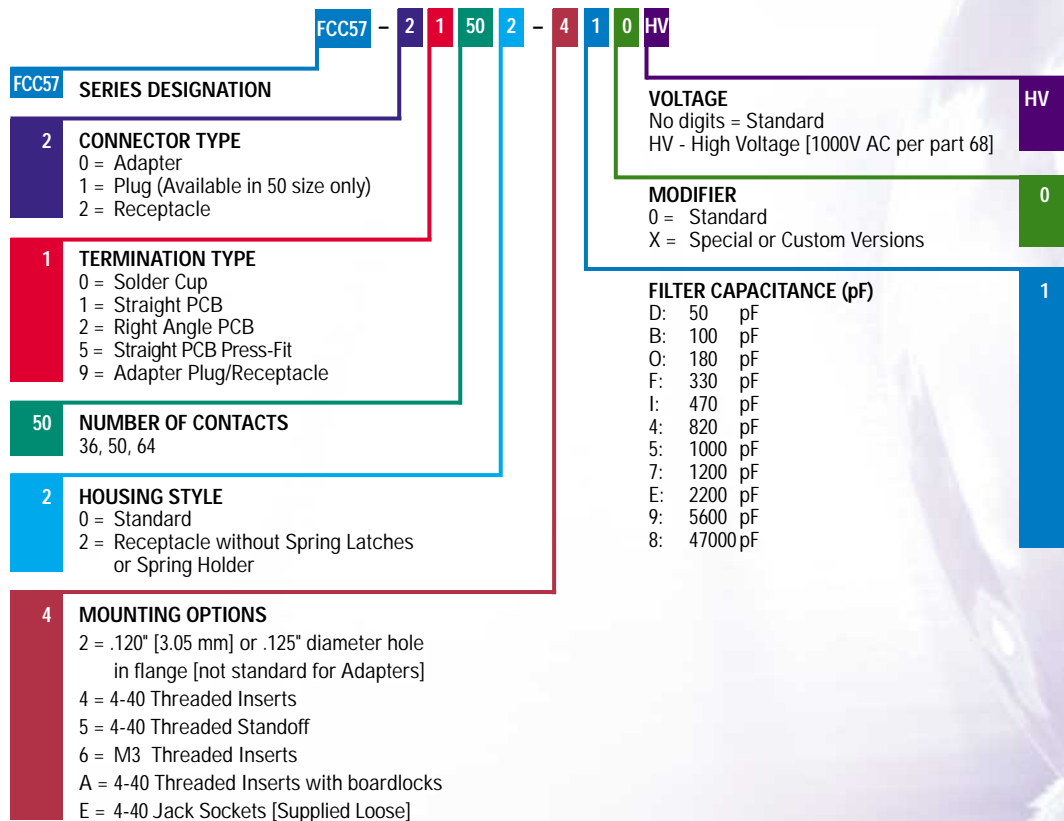

High voltage capacitors available (contact factory)

FCC57 Series

FILTERED MICRO-RIBBON CONNECTORS

Receptacle - 36, 50, 64 Size

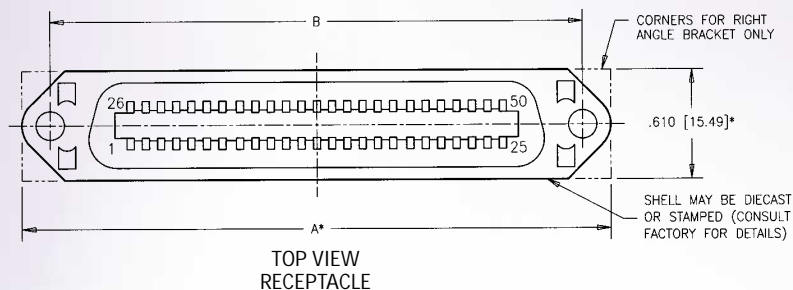

Connector Size	A	B
36	2.637 [66.98]	2.350 [59.69]
50	3.260 [82.80]	2.947 [74.85]
64	3.835 [97.41]	3.542 [89.97]

Dimensions are different for DieCast Shells
Consult Factory for details

Panel Mounting Dimensions - 36 / 50 / 64 size

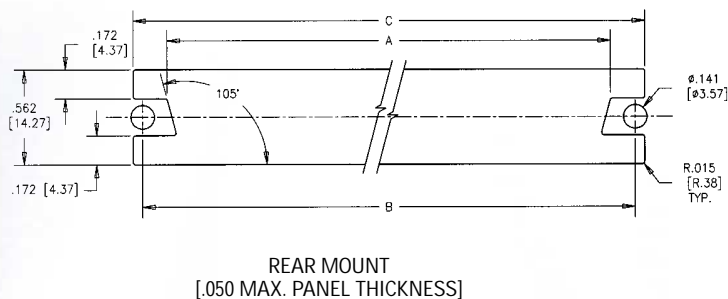

Connector Size	A	B	B
36	2.043 [71.05]	2.350 [59.69]	2.450 [85.20]
50	2.656 [92.36]	2.947 [74.85]	3.062 [106.48]
64	3.251 [113.06]	3.542 [89.97]	3.657 [127.18]

FCC57 Series 36 Size

FILTERED MICRO-RIBBON CONNECTORS

Receptacle

STRAIGHT PCB (FCC57 - 21360 - 1 x 0)

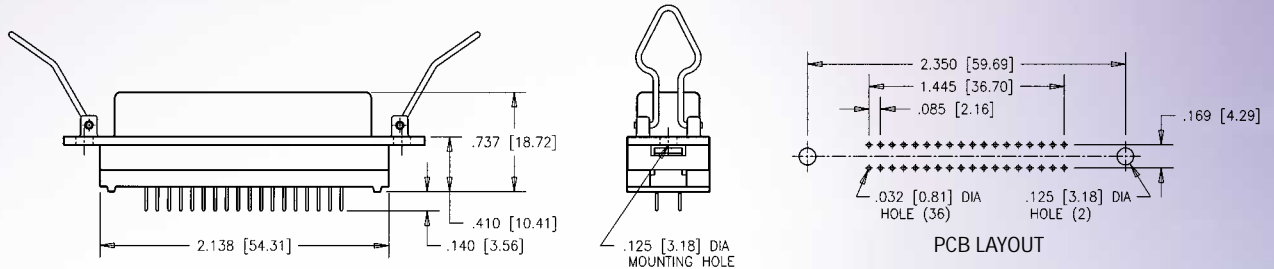

STRAIGHT PRESS-FIT (FCC57 - 25360 - 1 x 0)

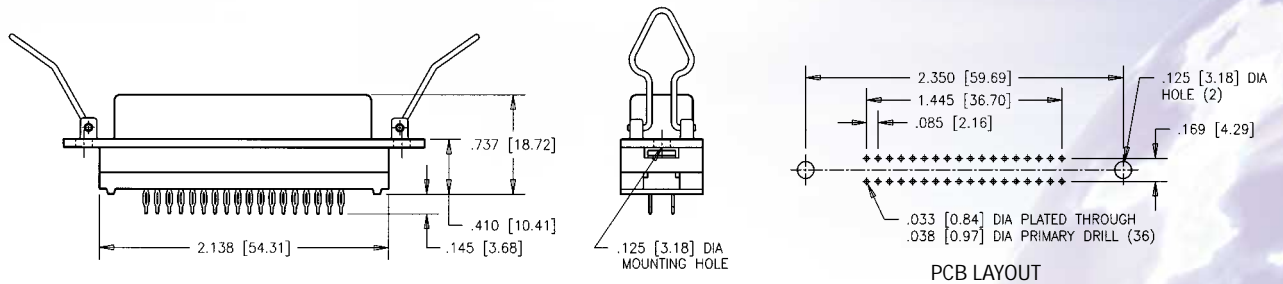

RIGHT ANGLE PCB (FCC57 - 22360 - 1 x 0)

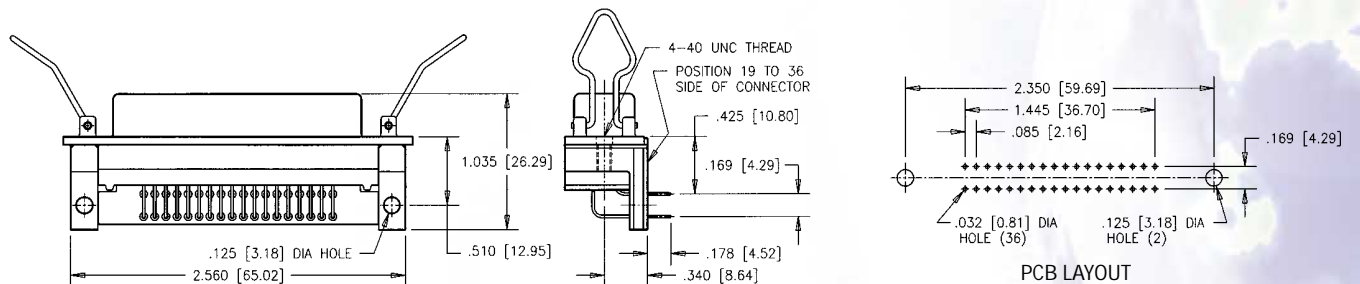

Adapter

PLUG/RECEPTACLE (FCC57 - 09360 - 1 X 0)

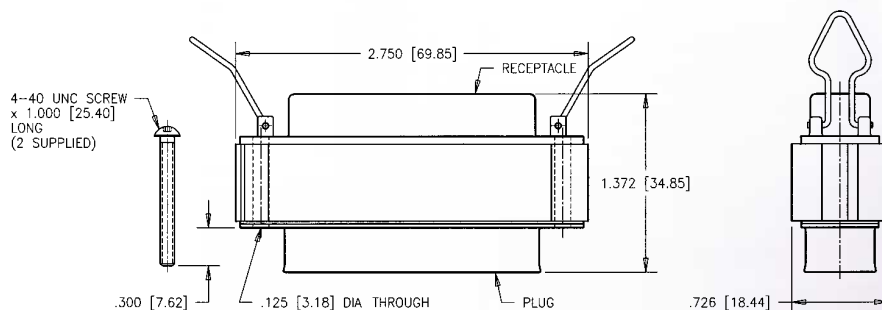

FCC57 Series 50 Size

FILTERED MICRO-RIBBON CONNECTORS

Receptacle

STRAIGHT PCB (FCC57 - 21500 - × × 0)

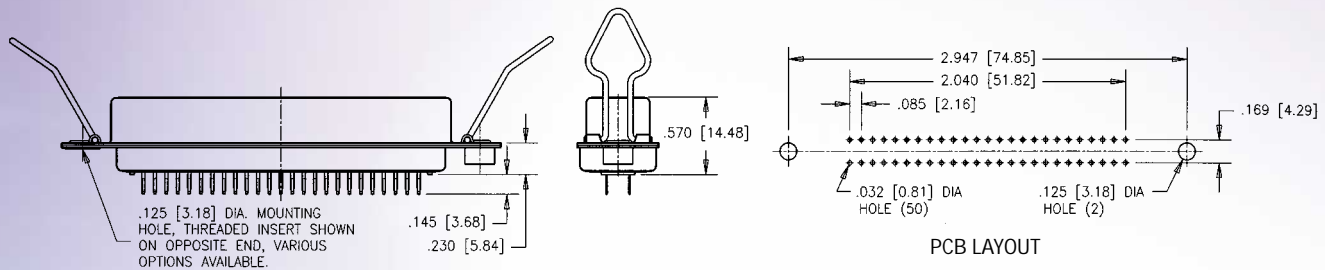

STRAIGHT PRESS-FIT (FCC57 - 25500 - × × 0)

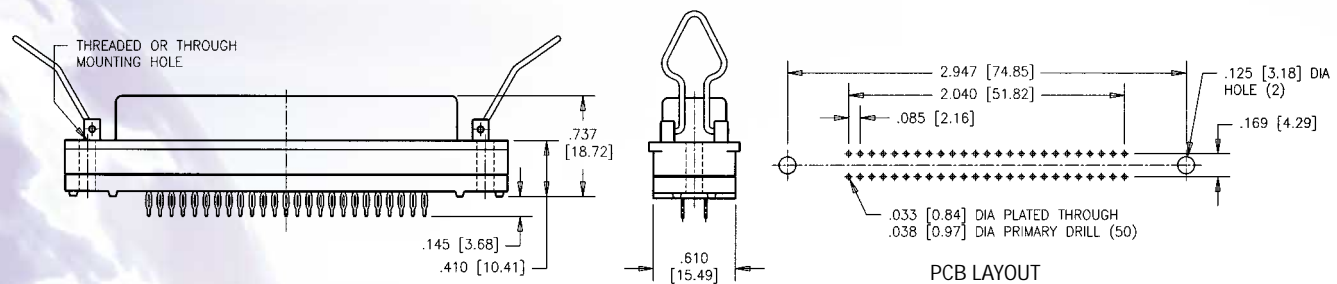

RIGHT ANGLE PCB (FCC57 - 22500 - × × 0)

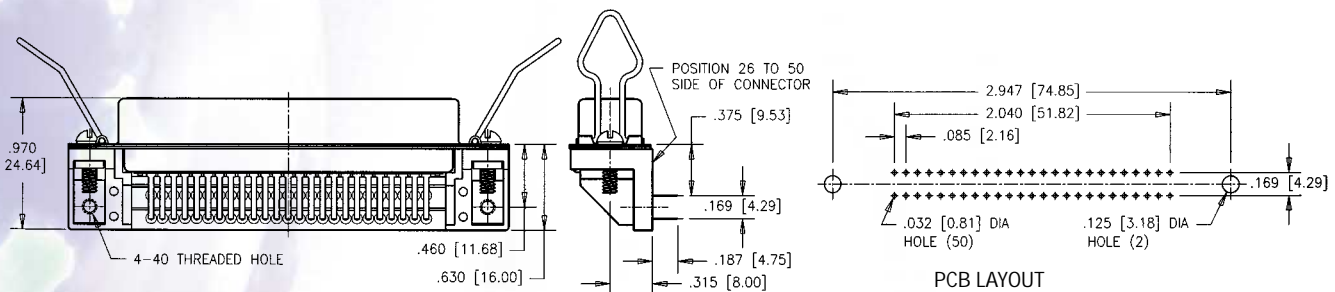

SOLDER CUP (FCC57 - 20500 - × × 0)

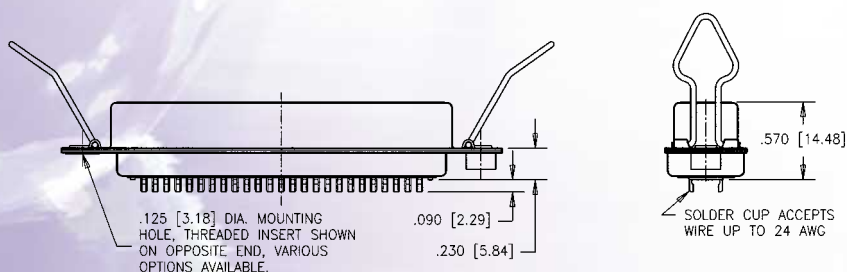

FCC57 Series 50 Size

FILTERED MICRO-RIBBON CONNECTORS

Plug

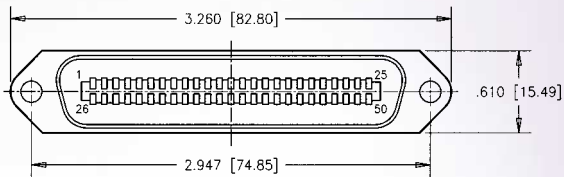

TOP VIEW
PLUG

STRAIGHT PCB (FCC57 - 11500 - × × 0)

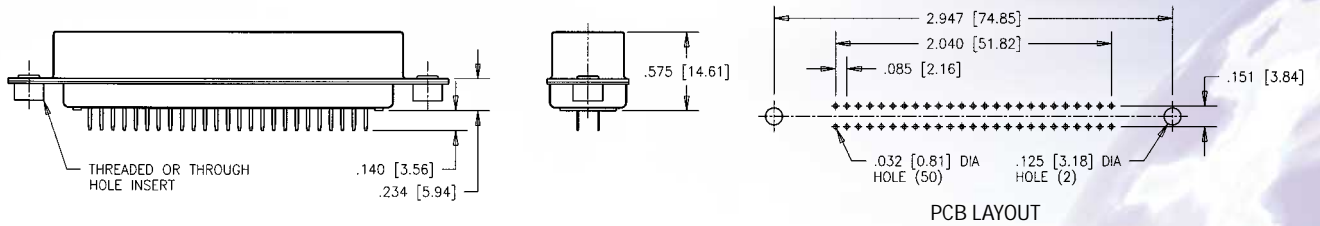

SOLDER CUP (FCC57 - 10500 - × × 0)

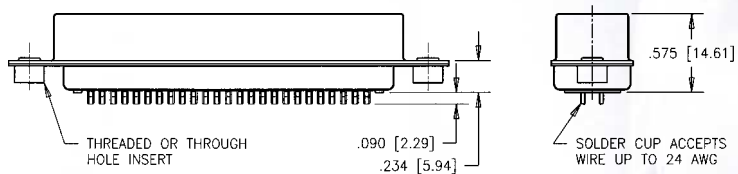

Adapter

PLUG/RECEPTACLE (FCC57 - 09500 - × × 0)

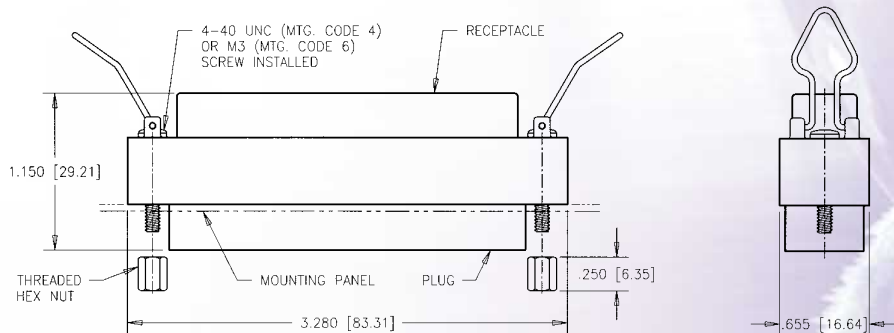

FCC57 Series 64 Size

FILTERED MICRO-RIBBON CONNECTORS

Receptacle

STRAIGHT PCB (FCC57 - 21640 - × 0)

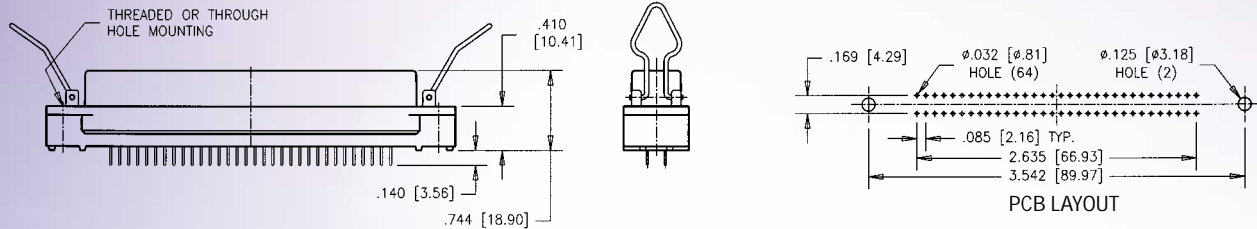

STRAIGHT PRESS-FIT (FCC57 - 25640 - × × 0)

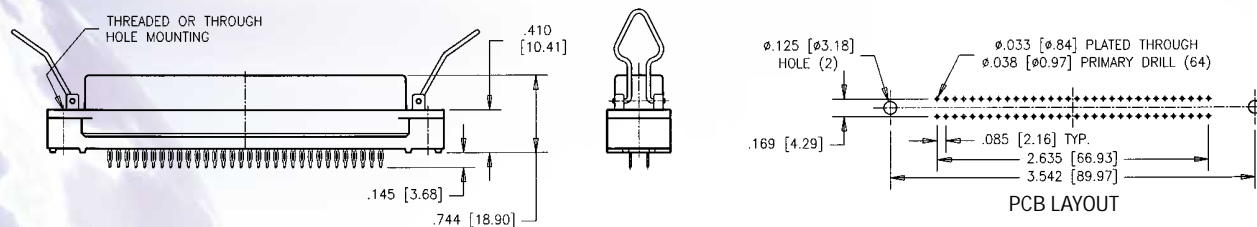

RIGHT ANGLE PCB (FCC57 - 22640 - × × 0)

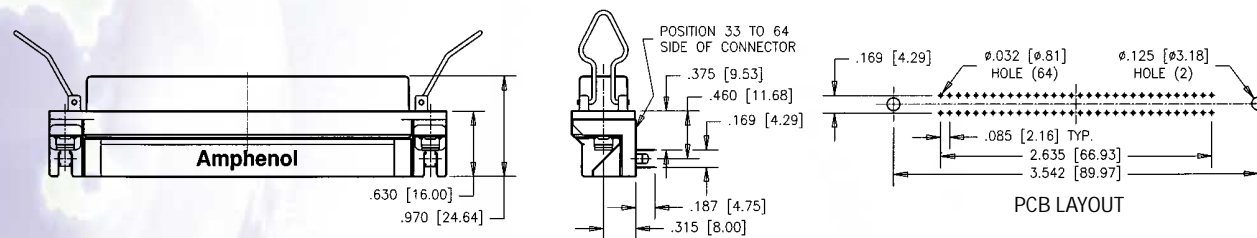

ADAPTER * (FCC57 - 09640 - × × 0)

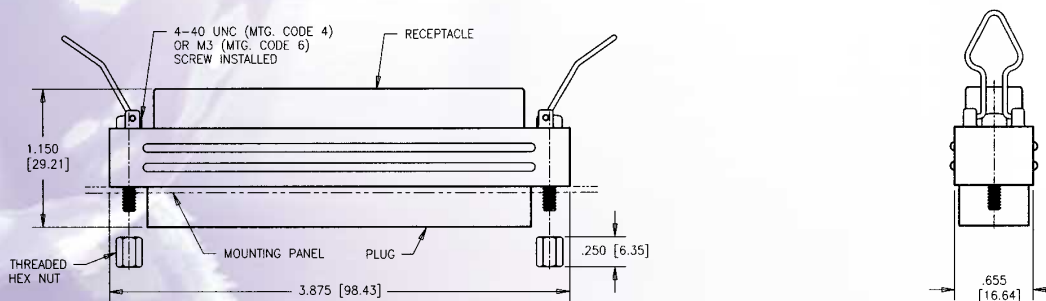

*Consult Factory

456 Series

CAPACITIVELY DECOUPLED RF CONNECTORS

Specifications

Mechanical Data:

Shell:	Zinc Diecast or Brass; Nickel plated
Insulator Body:	Thermoplastic
Contact Insulator:	Nylon or Teflon
Center Contact:	Phosphor Bronze or Beryllium Copper; Gold plated (456-107S is silver plated)
UL File # :	E135615
CSA File # :	LR68598

Filter Performance:

Capacitance	10,000 pF	
Working Voltage	200 VDC (500AC Rear Mt)	
DWV	600 VDC (1000VDC for Rear Mt)	
Filter Insertion Loss (dB)	1 MHz	4
(per MIL-STD-220	5 MHz	16
@ 25°C and	10 MHz	18
no load)	30 MHz	25
	50 MHz	30
	1000 MHz	30

* OTHER CAPACITANCE VALUES ARE AVAILABLE. CONSULT THE FACTORY FOR DETAILS.



These products are protected by U.S. Patent # 4,772,221.

Amphenol's 456 Series of RF connectors provides capacitive decoupling between the connector body and the mounting panel. EMI on the coaxial shield is shunted to the chassis ground through capacitors, while not affecting the DC and power supply frequencies. This reduces ground loop problems and provides a mechanism to harmlessly dissipate ESD to chassis ground.

The RF parameters of these connectors are the same as their non-filtered counterparts. Filtering does not affect the signal contact, but only the shell-to-ground connection. Capacitively decoupled RF connectors are intermateable and inter-changeable with standard non-filtered versions.

456 Series Construction

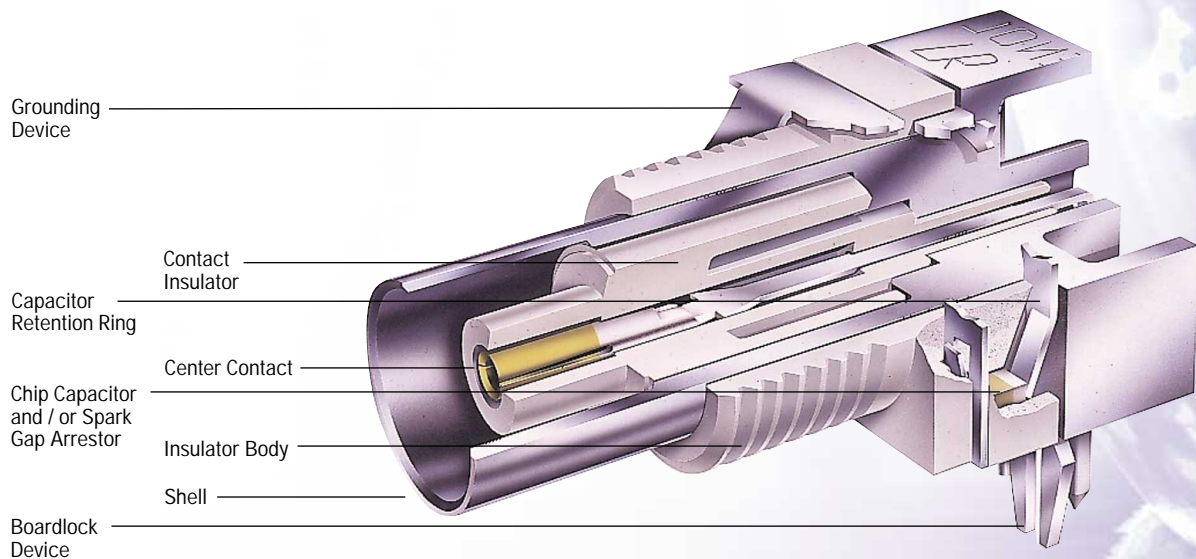

456 Series

CAPACITIVELY DECOUPLED RF CONNECTORS

Rear Mount BNC, Right Angle, PCB

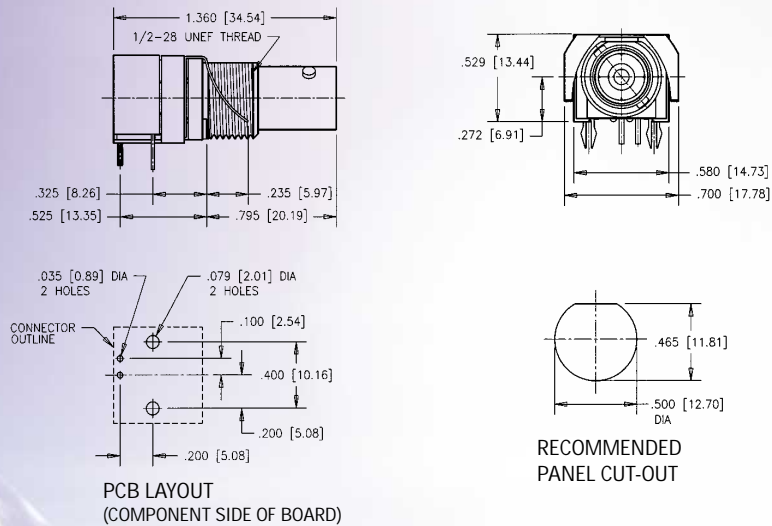

Type	50 Ω	75 Ω
Filtered	456-117	456-717
Filtered (10,000pF), 1000V Spark Gap	456-117S	456-717S
Filtered (10,000pF), 1000V Spark Gap, 1 M Ω Resistor	456-117F	456-717F
Grounded	456-117G	456-717G
Non-Filtered, Panel Insulated (no ground spring)	456-117NF	456-717NF

Rear Mount BNC, Crimp, Cable Size RG179

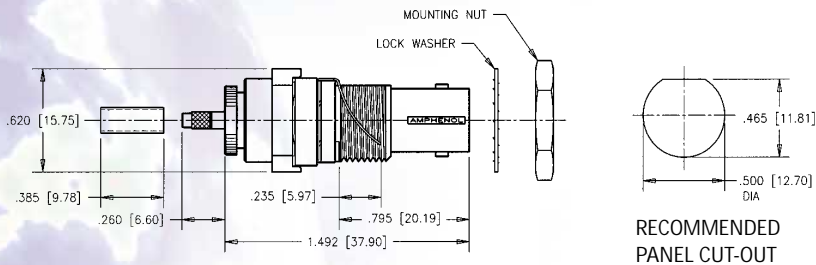

Type	50 Ω	75 Ω
Filtered	456-208	456-218
Grounded	456-208G	456-218G

Note: Also available with Spark gap and / or resistor
* Other Cable Sizes Available. Consult Factory.

Vertical Mount BNC, Press-Fit

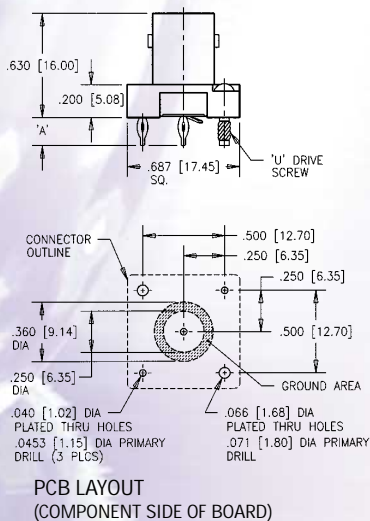

Type	50 Ω	75 Ω	Board Thickness	"A"
Filtered	--	456-107A	.125 (3.18)	.170 (4.32)
Non-Filtered	--	456-107ANF	.125 (3.18)	.170 (4.32)
Filtered	--	456-107B	.200 (5.08)	.255 (6.48)
Non-Filtered	--	456-107BNF	.200 (5.08)	.255 (6.48)

-- Consult Factory for Part Number

456 Series

CAPACITIVELY DECOUPLED RF CONNECTORS

Front Mount BNC, Right Angle PCB

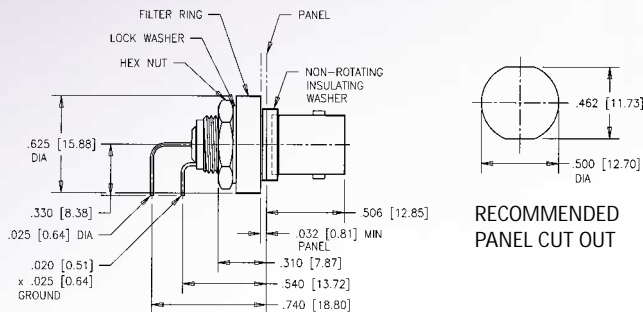

Type	50 Ω	75 Ω
Filtered	--	456-107

-- Consult factory for part number

Front Mount BNC packaging consists of connector, insulating washer, filter ring, lock washer and hex nut.

Front Mount BNC, Solder-Cup

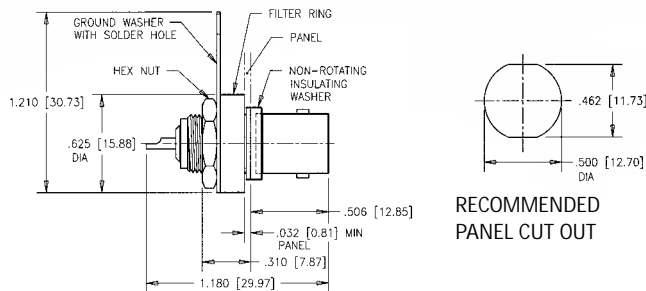

Type	50 Ω	75 Ω
Filtered	456-107SG	456-107TG

456-107S has silver plated contact (50 Ω).

* Overall part length
1.180 (29.97) for 456-107S
1.245 (31.62) for 456-107SG & 456-107TG.

Front Mount BNC packaging consists of connector, insulating washer, filter ring, ground washer and hex nut.

Jack-to-Jack Adapter

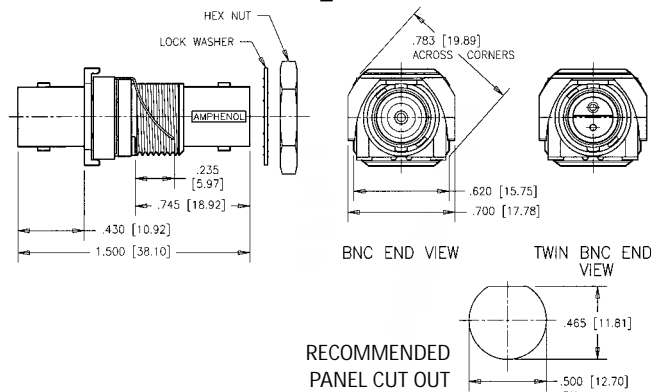

Type	50 Ω	75 Ω
BNC:	Filtered	456-915
Twin BNC:	Filtered	456-920

TNC Bulkhead Jack, Crimp (RG58/U Cable)

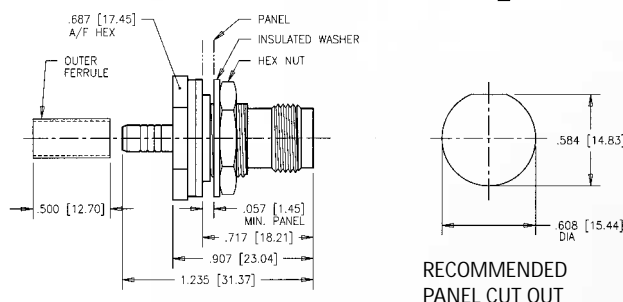

Type	50 Ω	75 Ω
Filtered	456-102	--

-- Consult factory for part number

Packaging consists of connector, mounting hardware, panel insulator, crimp ferrule and heat shrink tubing.

Amphenol Catalogues

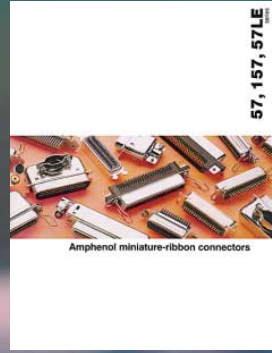
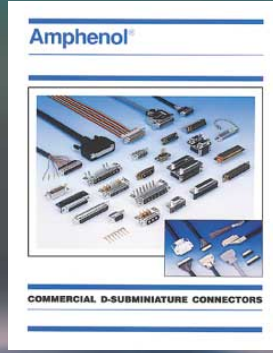

DATA /TELECOM PRODUCTS

20 Melford Drive
Scarborough, Ontario
Canada M1B 2X6

Telephone 416 754-5656
Facsimile 416 754-8668

Amphenol®

© Amphenol Canada Corp.
Specifications subject to change without notice
Printed in Canada
Design: Macrae Design Inc.

CATALOGUE NR. ADT 0001/01-06

Mouser Electronics

Authorized Distributor

Click to View Pricing, Inventory, Delivery & Lifecycle Information:

Amphenol:

[FCC17-C37PN-540](#) [FCC17-A15SA-410](#) [FCC17-A15SA-450](#) [FCC17-E09PA-440](#) [FCC17-E09AD-250](#) [FCC17-B25SA-440](#) [FCC17-B25SA-410](#) [FCC17-B25SA-490](#) [FCC17-E09PC-44B](#) [FCC17-E09PC-49B](#) [FCC17-B25PA-410](#) [FCC17-B25PA-490](#) [FCC17-A15AD-3E0](#) [FCC17-C37PA-490](#) [FCC17-C37PA-440](#) [FCC17-C37SA-440](#) [FCC17-A15SC-44B](#) [FCC17-E09PM-490](#) [FCC17-E09SA-450](#) [FCC17-E09SA-410](#) [FCC17-E09SA-440](#) [FCC17-E09SA-490](#) [FCC17-A15SM-240](#) [FCC17-A15SM-210](#) [FCC17-E09AD-410](#) [FCC17-E09PA-40BL](#) [FCC17-A15SB-410](#) [FCC17-B25SN-410](#) [FCC17-B25PC-49F](#) [FCC17-B25SM-290](#) [FCC17-A15AD-210](#) [FCC17-A15AD-250](#) [FCC17-B25SC-4E0](#) [FCC17-E09PE-410](#) [FCC17-A15PA-410](#) [FCC17-A15PA-440](#) [FCC17-A15PA-490](#) [FCC17-A15SN-400](#) [FCC17-B25SM-250](#) [FCC17-E09PA-490](#) [FCC17-B25AD-250](#) [FCC17-B25AD-210](#) [FCC17-E09PA-410](#) [FCC17-C37SA-4EB](#) [FCC17-B25SC-41B](#) [FCC17-B25SC-49B](#) [FCC17-B25SC-44B](#) [FCC17-E09AD-210](#) [FCC17-A15PM-210](#) [FCC17-A15PM-240](#) [FCC17-B25PM-240](#) [FCC17-A15SA-440](#) [FCC17-E09SN-490](#) [FCC17-A15PE-410](#) [FCC17-A15PE-490](#) [FCC17-B25PA-440](#) [FCC17-B25AD-240](#) [FCC17-B25SM-390](#) [FCC17-E09SE-410](#) [FCC17-E09SM-210](#) [FCC17-E09SM-240](#) [FCC17-E09SM-290](#) [FCC17-B25PM-210](#) [FCC17-B25PM-290](#) [FCC17-E09SC-44B](#) [FCC17-E09PE-A50](#) [FCC17-A15SE-410](#) [FCC17-E09PM-240](#) [FCC17-E09PM-290](#) [FCC17-E09PM-210](#) [FCC17-E09PM-250](#) [FCC17-A15PC-44B](#) [FCC17-A15PC-49F](#) [FCC17-A15PC-49B](#) [FCC17-E09SN-A10](#) [FCC17-B25PN-2E0](#) [FCC17-E09SA-41B](#) [FCC17-A15PC-34B](#) [FCC17-A3W3PR-K81](#) [FCC17-B25PC-3EB](#) [FCC17-C37PA-E50](#) [FCC17-E09PA-450L](#) [FCC17-E09SM-490](#) [FCC17A15PA640](#) [FCC17A15PA64B](#) [FCC17A15PA650](#) [FCC17A15PA65B](#) [FCC17A15PA680](#) [FCC17A15PA68B](#) [FCC17A15PA690](#) [FCC17A15PA69B](#) [FCC17A15PA6D0](#) [FCC17A15PA6DB](#) [FCC17A15PA6E0](#) [FCC17A15PA6EB](#) [FCC17A15PB200](#) [FCC17A15PB20B](#) [FCC17A15PB210](#) [FCC17A15PB21B](#) [FCC17A15PB240](#)