

Coiltronics HCV1206 Family

High current power inductors

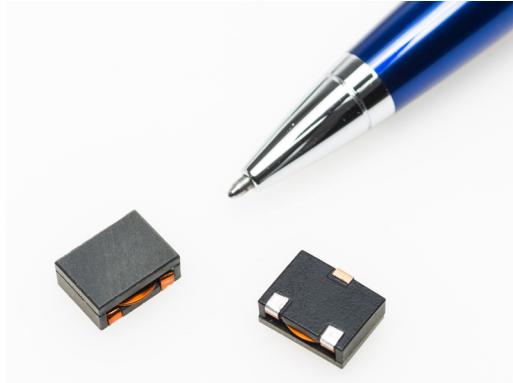

Applications

- Compatible with Picor® Cool-Power® ZVS Buck and Buck-Boost Regulator Families (Picor part number series PI37xx and PI35xx)

Environmental Data

- Storage temperature range (component): -55°C to +125°C
- Operating temperature range: -55°C to +125°C (ambient plus self-temperature rise)
- Solder reflow temperature: J-STD-020D compliant

Description

- Flat-wire construction
- Low DCR, high efficiency
- Secure 3 terminal mounting
- 12.7 x 10.15mm footprint surface mount package in a 5.1mm height
- Ferrite core material
- Halogen free, lead free, RoHS compliant



Picor® and Cool-Power® are trademarks of Vicor Corporation.



Product Specifications

Part Number ⁴	OCL ¹ (μH) $\pm 10\%$	I_{rms}^2 (amps)	I_{sat}^3 (amps)	DCR (m Ω) @ 20°C $\pm 10\%$
HCV1206-R42-R	0.42	16	42	3.15
HCV1206-R48-R	0.48	16	37	3.15
HCV1206-R90-R	0.90	14	28	4.6
HCV1206-1R0-R	1.0	14	24.5	4.6
HCV1206-1R5-R	1.5	12	21	6.0
HCV1206-2R0-R	2.0	12	16	6.0
HCV1206-3R0-R	3.0	11	13	7.4

1. Open Circuit Inductance (OCL) Test Parameters: 100kHz, 0.1Vrms, 0.0Adc, 25°C

2. I_{rms} : DC current for an approximate temperature rise of 40°C without core loss. Derating is necessary for AC currents. PCB layout, trace thickness and width, air-flow, and proximity of other heat generating components will affect the temperature rise. It is recommended that the temperature of the part not exceed 125°C under worst case operating conditions verified in the end application.

3. I_{sat} : Peak current for approximately 5% rolloff @ +25°C

4. Part Number Definition: HCV1206-xxx-R
HCV1206 = Product code and size
xxx=Inductance value in μH ,
-R suffix = RoHS compliant

Dimensions (mm)

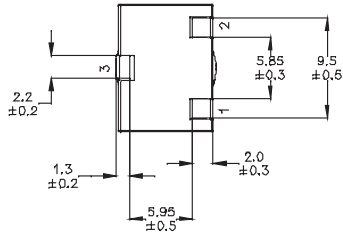
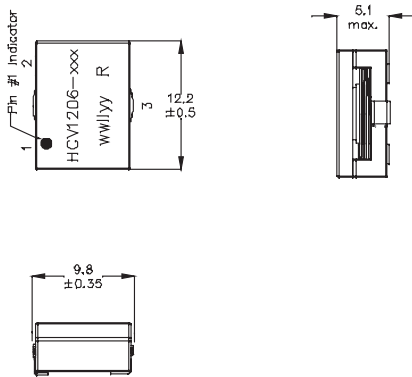

Recommended Pad Layout

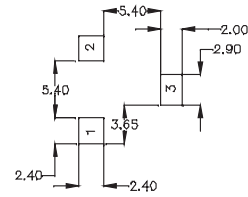

Schematic

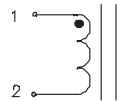

Part marking: HCV1206-xxx, xxx=inductance value in μH , R=decimal point, wwlllyy= date code, R=revision level
Soldering surfaces to be coplanar within 0.1 millimeters
Pin 3 is for mounting stability. No connection.
Do no route traces or vias underneath the inductor.

Packaging information (mm)

Supplied in tape and reel packaging, 550 parts per 13" diameter reel

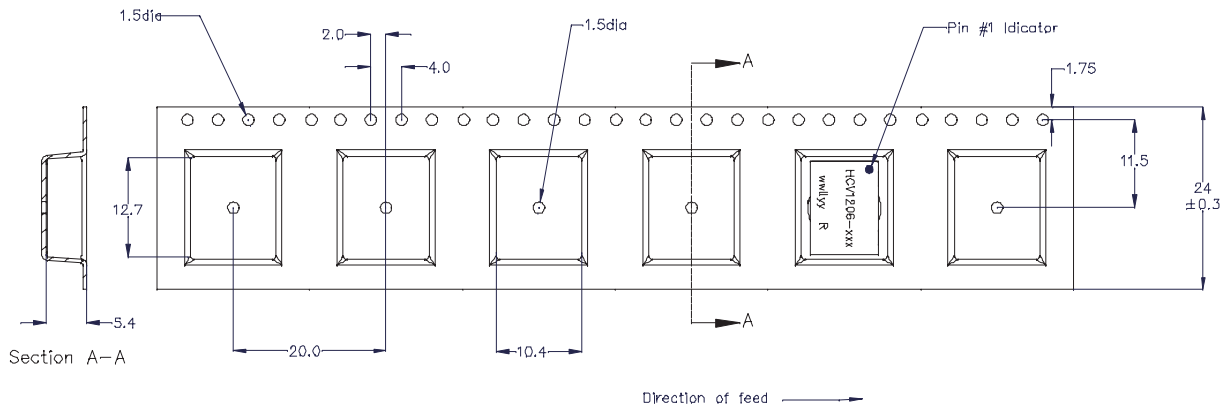

Inductance characteristics

HCV1206-R42-R

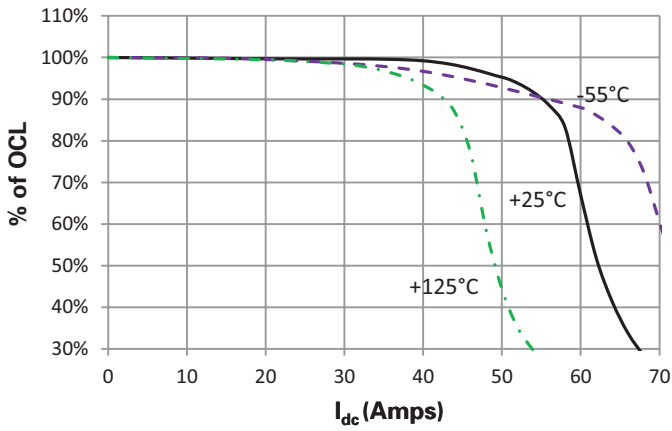

HCV1206-R48-R

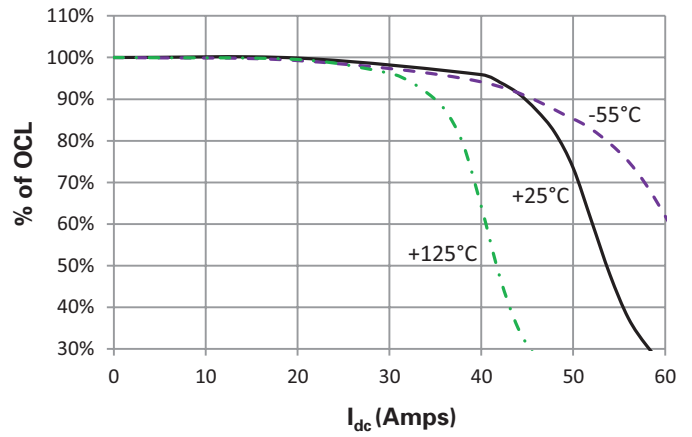

HCV1206-R90-R

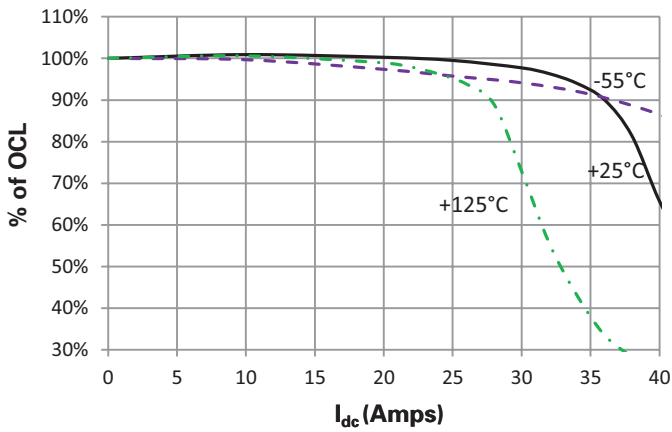

HCV1206-1R0-R

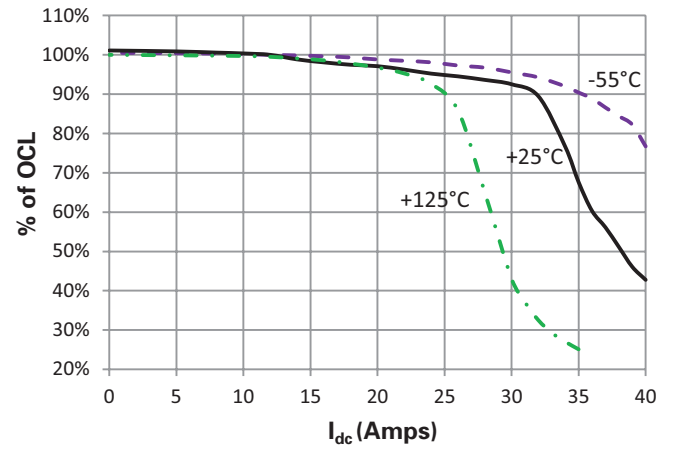

Inductance characteristics

HCV1206-1R5-R

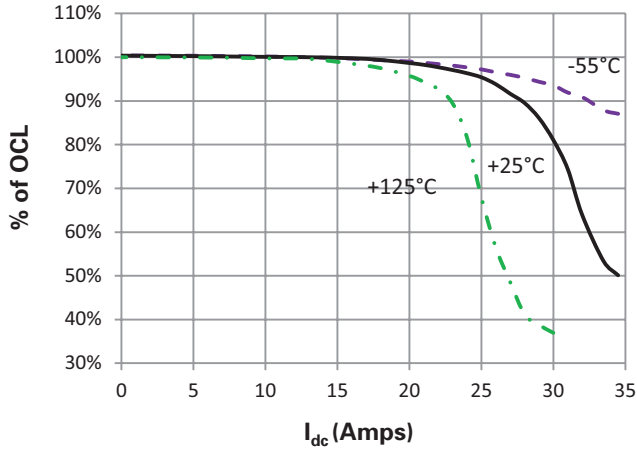

HCV1206-2R0-R

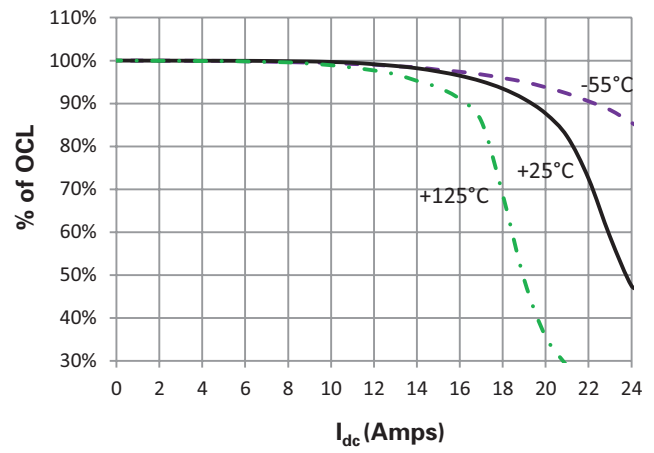

HCV1206-3R0-R

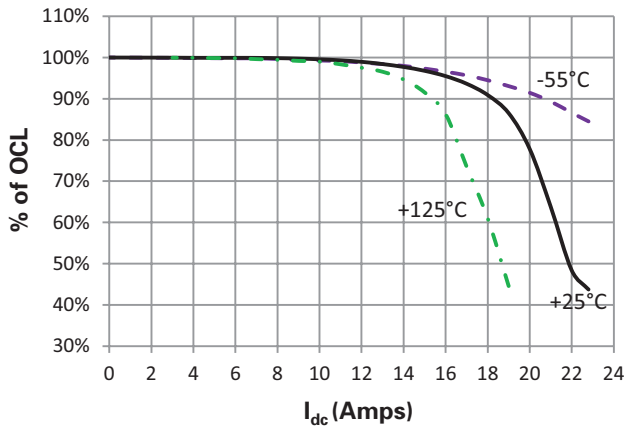

Solder reflow profile

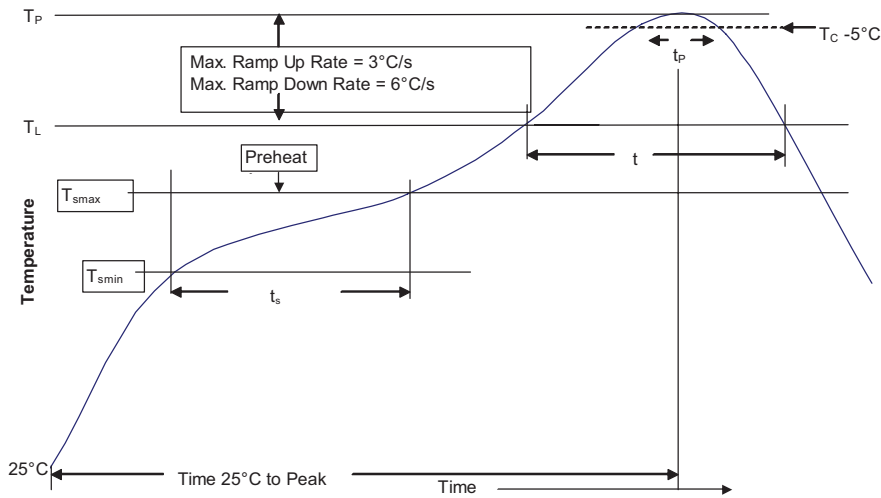

Table 1 - Standard SnPb Solder (T_c)

Package Thickness	Volume mm ³ <350	Volume mm ³ ≥350
<2.5mm)	235°C	220°C
≥2.5mm	220°C	220°C

Table 2 - Lead (Pb) Free Solder (T_c)

Package Thickness	Volume mm ³ <350	Volume mm ³ 350 - 2000	Volume mm ³ >2000
<1.6mm	260°C	260°C	260°C
1.6 - 2.5mm	260°C	250°C	245°C
>2.5mm	250°C	245°C	245°C

Reference JDEC J-STD-020D

Profile Feature	Standard SnPb Solder	Lead (Pb) Free Solder
Preheat and Soak	• Temperature min. (T _{smin})	100°C
	• Temperature max. (T _{smax})	150°C
	• Time (T _{smin} to T _{smax}) (t _s)	60-120 Seconds
Average ramp up rate T _{smax} to T _p	3°C/ Second Max.	3°C/ Second Max.
Liquidous temperature (T _L)	183°C	217°C
Time at liquidous (t _L)	60-150 Seconds	60-150 Seconds
Peak package body temperature (T _p)*	Table 1	Table 2
Time (t _p)** within 5 °C of the specified classification temperature (T _c)	20 Seconds**	30 Seconds**
Average ramp-down rate (T _p to T _{smax})	6°C/ Second Max.	6°C/ Second Max.
Time 25°C to Peak Temperature	6 Minutes Max.	8 Minutes Max.

* Tolerance for peak profile temperature (T_p) is defined as a supplier minimum and a user maximum.

** Tolerance for time at peak profile temperature (t_p) is defined as a supplier minimum and a user maximum.

Life Support Policy: Eaton does not authorize the use of any of its products for use in life support devices or systems without the express written approval of an officer of the Company. Life support systems are devices which support or sustain life, and whose failure to perform, when properly used in accordance with instructions for use provided in the labeling, can be reasonably expected to result in significant injury to the user.

Eaton
Electronics Division
1000 Eaton Boulevard
Cleveland, OH 44122
United States
www.eaton.com/elx

© 2015 Eaton
All Rights Reserved
Printed in USA
Publication No. 10354-BU-SB15161
April 2015

Eaton is a registered trademark.

All other trademarks are property of their respective owners.

Mouser Electronics

Authorized Distributor

Click to View Pricing, Inventory, Delivery & Lifecycle Information:

[Eaton:](#)

[HCV1206-3R0-R](#) [HCV1206-R90-R](#) [HCV1206-1R5-R](#) [HCV1206-2R0-R](#) [HCV1206-R42-R](#) [HCV1206-1R0-R](#)
[HCV1206-R48-R](#)