



TECHNICAL DATA



RELATIVE HUMIDITY SENSOR

HS 1100 / HS 1101

Based on a unique capacitive cell, these relative humidity sensors are designed for high volume, cost sensitive applications such as **office automation, automotive cabin air control, home appliances, and industrial process control systems**. They are also useful in all applications where humidity compensation is needed.

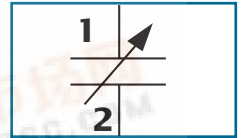

FEATURES

- Full interchangeability with no calibration required in standard conditions
- Instantaneous desaturation after long periods in saturation phase
- Compatible with automatized assembly processes, including wave soldering, reflow and water immersion (1)
- High reliability and long term stability
- Patented solid polymer structure
- Suitable for linear voltage or frequency output circuitry
- Fast response time
- Individual marking for compliance to stringent traceability requirements

(1) soldering temperature profiles available on request

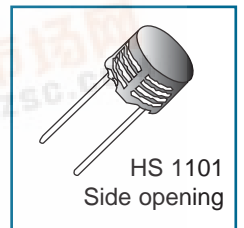

MAXIMUM RATINGS (Ta= 25°C unless otherwise noted)

Ratings	Symbol	Value	Unit
Operating Temperature	Ta	-40 to 100	°C
Storage Temperature	Tstg	-40 to 125	°C
Supply Voltage	Vs	10	Vac
Humidity Operating Range	RH	0 to 100	% RH
Soldering @ T = 260°C	t	10	s

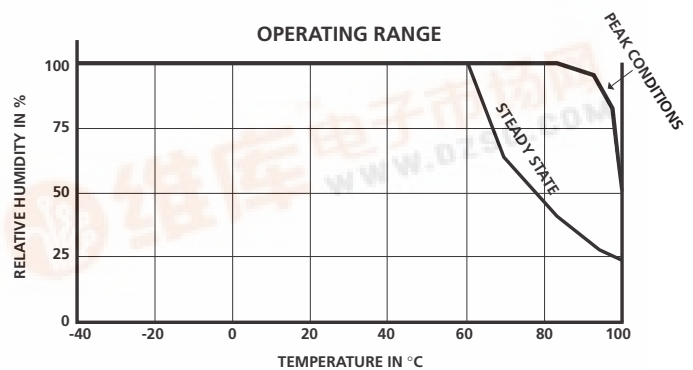

CHARACTERISTICS (Ta = 25°C, measurement frequency @ 10kHz unless otherwise noted)

Characteristics	Symbol	Min.	Typ.	Max.	Unit.
Humidity measuring range	RH	1		99	%
Supply voltage	Vs		5	10	V
Nominal capacitance @ 55% RH*	C	177	180	183	pF
Temperature coefficient	Tcc		0.04		pF/°C
Averaged Sensitivity from 33% to 75% RH	ΔC/%RH		0.34		pF/%RH
Leakage current (Vcc = 5 Volts)	Ix		1		nA
Recovery time after 150 hours of condensation	tr		10		s
Humidity Hysteresis			+/-1.5		%
Long term stability			0.5		%RH/yr
Response time (33 to 76 % RH, still air @ 63%)	ta		5		s
Deviation to typical response curve (10% to 90% RH)			+/-2		% RH

* Tighter specification available on request



CHARACTERISTICS (CONT'D)

**Typical response curve
of HS 1100/HS 1101 in humidity**

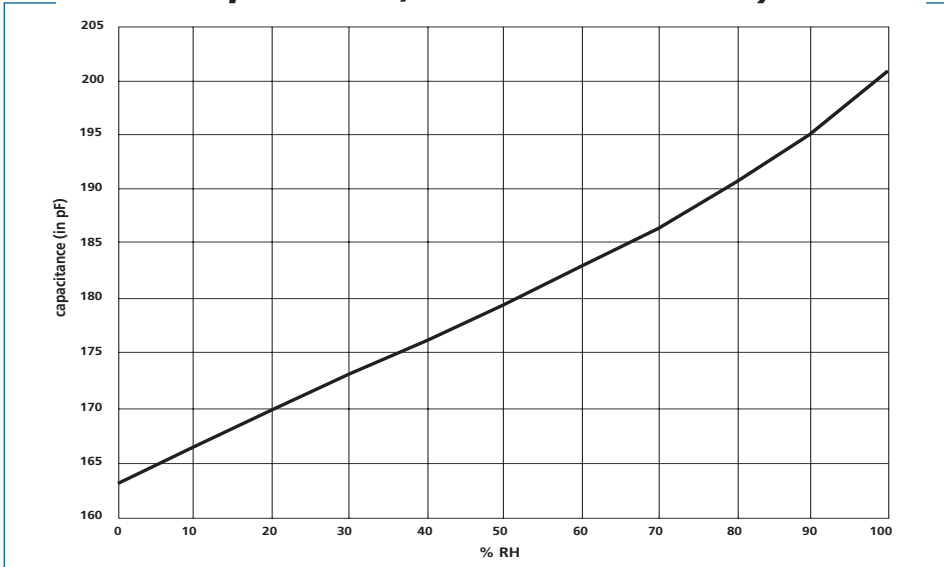

Calibration data are traceable to NIST standards through CETIAT laboratory.

Measurement frequency : 10kHz
Ta = 25°C

Polynomial response : $C(pf) = C@55\% * (1.2510^{-7} RH^3 - 1.3610^{-5} RH^2 + 2.1910^{-3} RH + 9.010^{-1})$
RH in % RH

Measurement frequency influence

In this data sheet, all capacitance measurements are @ 10kHz. However, the sensor can operate without restriction from 5kHz to 100kHz. To calculate the influence of frequency on capacitance measurements :

$$C@fkHz = C@10kHz (1.027 - 0.01185 \ln(fkHz))$$

Polarization

In order to get a better reproducibility during measurements, always connect the case of the header (pin 2) to the ground of the circuit.

The case of the header is located on the opposite side of the tab.

Soldering instructions : see the Application Note HPC007

PROPORTIONAL VOLTAGE OUTPUT CIRCUIT

Internal Block Diagram

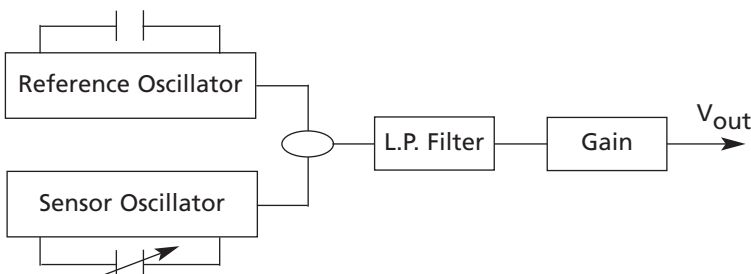

$$V_{out} = V_{cc} * (0.00474 * \%RH + 0.2354)$$

for 5 - 99% RH

Typical temperature coefficient :
+0.1% RH/°C - From 10 to 60°C

DEMO BOARD AVAILABLE ON REQUEST (REF HM1510)

Typical Characteristics for Voltage Output Circuit

At V_{cc} 5V - 25°C

RH Voltage (V)	0	10	20	30	40	50	60	70	80	90	100
	-	1.41	1.65	1.89	2.12	2.36	2.60	2.83	3.07	3.31	3.55

FREQUENCY OUTPUT CIRCUITS

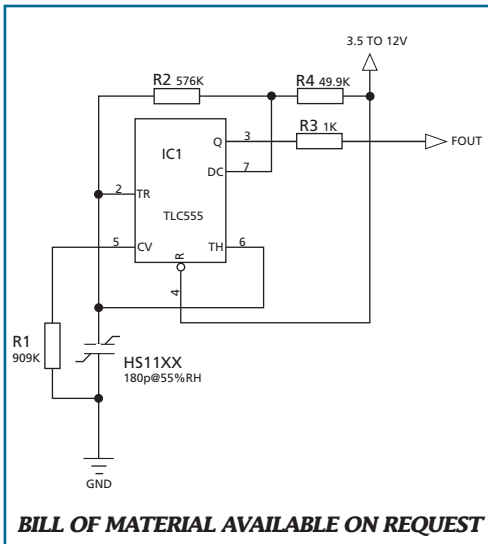

COMMENTS

This circuit is the typical astable design for 555. The HS1100/HS1101, used as variable capacitor, is connected to the TRIG and THRES pin. Pin 7 is used as a short circuit pin for resistor R4.

The HS1100/HS1101 equivalent capacitor is charged through R2 and R4 to the threshold voltage (approximately 0.67Vcc) and discharged through R2 only to the trigger level (approximately 0.33Vcc) since R4 is shorted to ground by pin 7.

Since the charge and discharge of the sensor run through different resistors, R2 and R4, the duty cycle is determined by :

$$t_{high} = C@ \%RH * (R2 + R4) * \ln 2$$

$$t_{low} = C@ \%RH * R2 * \ln 2$$

$$F = 1 / (t_{high} + t_{low}) = 1 / (C@ \%RH * (R4 + 2 * R2) * \ln 2)$$

$$\text{Output duty cycle} = t_{high} * F = R2 / (R4 + 2 * R2)$$

To provide an output duty cycle close to 50%, R4 should be very low compared to R2 but never under a minimum value.

Resistor R3 is a short circuit protection. 555 must be a CMOS version.

REMARK

R1 unbalances the internal temperature compensation scheme of the 555 in order to introduce a temperature coefficient that matches the HS1100/HS1101 temperature coefficient. In all cases, R1 should be a 1% resistor with a maximum of 100ppm coefficient temperature like all other R-C timer resistors. Since 555 internal temperature compensation changes from one trademark to one other, R1 value should be adapted to the specific chip. To keep the nominal frequency of 6660Hz at 55%RH, R2 also needs slight adjustment as shown in the table.

555 Type	R1	R2
TLC555 (Texas)	909kΩ	576kΩ
TSS55 (STM)	100nF capacitor	523kΩ
7555 (Harris)	1732kΩ	549kΩ
LMC555 (National)	1238kΩ	562kΩ

For a frequency of 6660Hz at 55%RH

Typical Characteristics for Frequency Output Circuits

REFERENCE POINT AT 6660Hz FOR 55%RH / 25°C

RH	0	10	20	30	40	50	60	70	80	90	100
Frequency	7351	7224	7100	6976	6853	6728	6600	6468	6330	6186	6033

Typical for a 555 Cmos type. TLC555 (RH : Relative Humidity in %, F : Frequency in Hz)

Polynomial response :

$$F_{mes}(Hz) = F_{55}(Hz) (1.1038 - 1.936810^{-3} * RH + 3.011410^{-6} * RH^2 - 3.440310^{-8} * RH^3)$$

Measurement Error vs Stray Capacitance

A special attention is required in order to minimize stray capacitance in the layout. The added capacitance will act as a parallel capacitance with the sensor and create a measurement error.

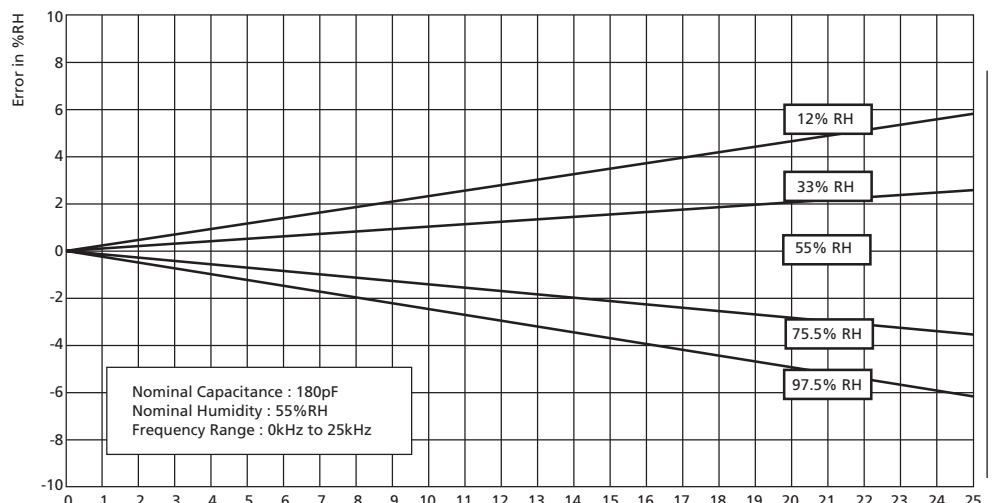

● QUALIFICATION PROCESS

- HS1100/HS1101 sensors have been qualified through a complete qualification process taking in account many of the requirements of the MIL STD750 including :

Solder heat and solderability

Wave soldering at 260°C + DI water clean at 45°C

Mechanical shock - 1500 g, 5 blows, 3 directions

Vibration - Variable (F = 100 - 2000Hz), fixed (F = 35Hz)

Constant acceleration

Marking permanency

ESD - Electrostatic Discharge - Human body & Machine model

Salt Atmosphere MIL STD750/Method 1041/96 hours

Temperature Cycling - 40°C / +85°C

High Temperature / Humidity Operating Life - 93%RH / 60°C for 1000 hours

Low humidity storage life - RH < 10%/23°C - 1000 hours

Resistance to immersion in water at ambient temperature and 80°C - 160 hours

Resistance to acid vapors at 75000 ppm for nitric, sulfuric and chlorhydric acids

Resistance to many chemicals linked with home appliances/ automotive or consumer applications.

All these tests are regularly performed on different lots from production. **More information are available on request**

● Environmental and recycling information :

- HS1100/HS1101 sensors are lead free components

- HS1100/HS1101 sensors are free of Cr (VI), Cd and Hg.

PACKAGE OUTLINE HS1100

Dim	Min (mm)	Max (mm)
A	9.00	9.30
B	8.00	8.50
C	3.50	3.90
D	12.00	14.00
E	0.40	0.50
G	45° BCS	
H	0.70	1.10
J	0.70	0.90
K	4.83	5.33

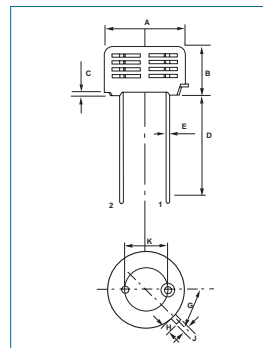
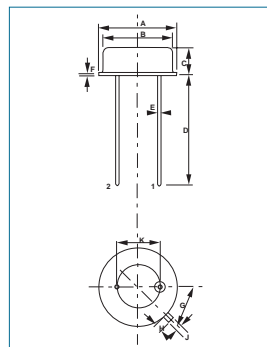

Dim	Min (mm)	Max (mm)
A	9.70	10.20
B	5.70	6.20
C	0.40	0.60
D	12.00	14.00
E	0.40	0.50
G	45° BCS	
H	0.70	1.10
J	0.70	0.90
K	4.83	5.33

PACKAGE OUTLINE HS1101

ORDERING INFORMATION :

HS 1100 : HPP 800 A 001 (MULTIPLE PACKAGE QUANTITY OF 50 PIECES)

HS 1101 : HPP 801 A 001 (MULTIPLE PACKAGE QUANTITY OF 48 PIECES)

CAPACITIVE RELATIVE HUMIDITY SENSOR.

**SAMPLE KIT OF HS1100-HS1101
IS AVAILABLE THROUGH
HUMIREL WEB SITE**

www.humirel.com

email : sales@humirel.com