

HSMM-C110/C120/C150/C170/C190

HSMN-C110/C120/C150/C170/C190/C191

SMT ChipLEDs



Data Sheet



Description

These small chip-type LEDs utilize high efficient InGaN/SiC material to deliver competitively priced high performance blue and green. These 525 nm green and 470 nm blue are unique hues which provide color differentiation to a product.

These ChipLEDs come in either top emitting packages (HSMx-C170, C190, C191, and C150) or in a side emitting package (HSMx-C110 and HSMx-C120). The side emitting package is especially suitable for LCD backlighting application. The top emitting packages with their wide viewing angle are suitable for direct backlighting application or being used with light pipes. In order to facilitate pick and place operation, these ChipLEDs are shipped in tape and reel with 4000 units per reel for HSMx-C120, C170, C190, and C191 packages, and 3000 units per reel for HSMx-C110 and C150 packages. All packages are compatible with IR soldering and binned by both color and intensity.

Features

- High brightness
- Small size
- Industrial standard footprint
- Diffused optics
- Top emitting or right angle emitting
- Compatible with IR soldering
- Compatible for use with light piping
- Available in 8 mm tape on 7" diameter reel
- Reel sealed in zip locked moisture barrier bags

Applications

- LCD backlighting
- Pushbutton backlighting
- Front panel indicator
- Symbol indicator
- Microdisplays
- Small message panel signage

Device Selection Guide

Package Dimension (mm) ^{[1], [2]}	Ingan Green	Ingan Blue	Package Description
3.2 (L) x 1.5 (W) x 1.0 (H)	HSMM-C110	HSMN-C110	Untinted, Non-diffused
1.6 (L) x 1.0 (W) x 0.6 (H)	HSMM-C120	HSMN-C120	Untinted, Nondiffused
3.2 (L) x 1.6 (W) x 1.1 (H)	HSMM-C150	HSMN-C150	Untinted, Diffused
2.0 (L) x 1.25 (W) x 0.8 (H)	HSMM-C170	HSMN-C170	Untinted, Diffused
1.6 (L) x 0.8 (W) x 0.8 (H)	HSMM-C190	HSMN-C190	Untinted, Diffused
1.6 (L) x 0.8 (W) x 0.6 (H)		HSMN-C191	Untinted, Diffused

Notes:

1. Dimensions in mm.

2. Tolerance ± 0.1 mm unless otherwise noted.

CAUTION: HSMM-C1xx and HSMN-C1xx LEDs are Class 1A ESD sensitive per JESD22-A114C.01. Please observe appropriate precautions during handling and processing. Refer to Avago Technologies Application Note AN-1142 for additional details.

Package Dimensions

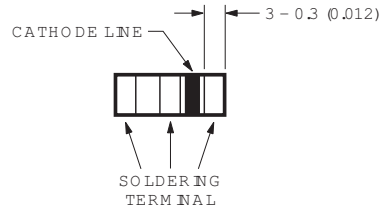
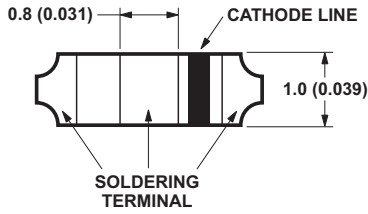
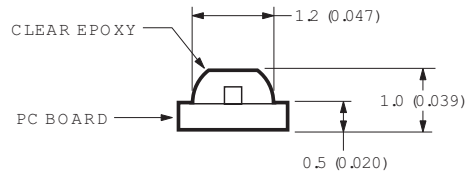
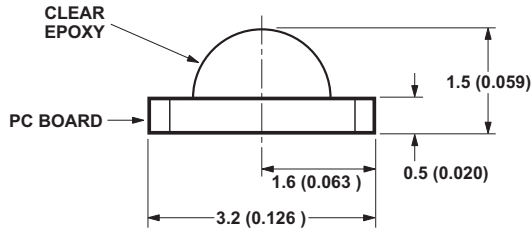
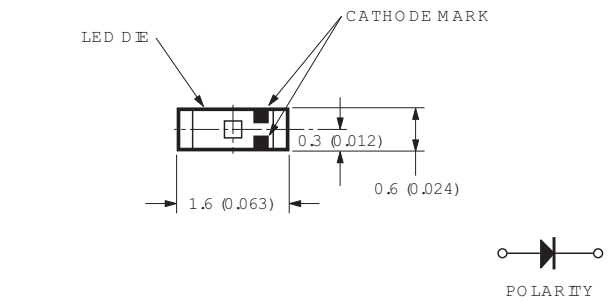
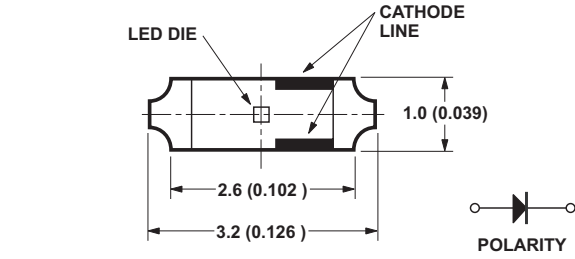

HSMx-C110

HSMx-C120

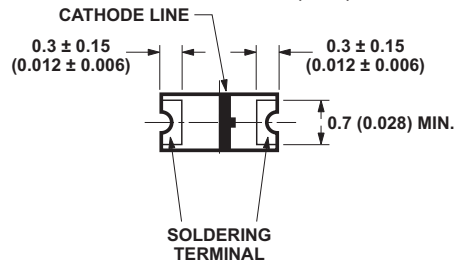
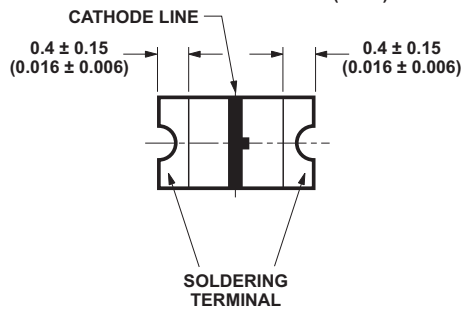
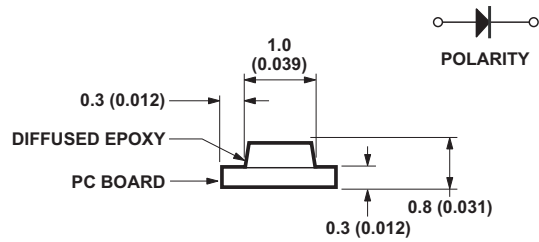
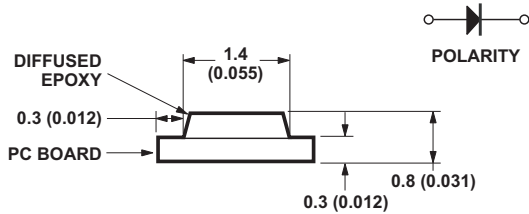
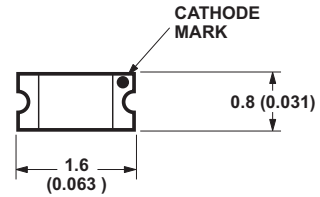
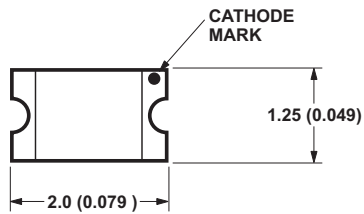

HSMx-C170

HSMx-C190

Package Dimensions, continued

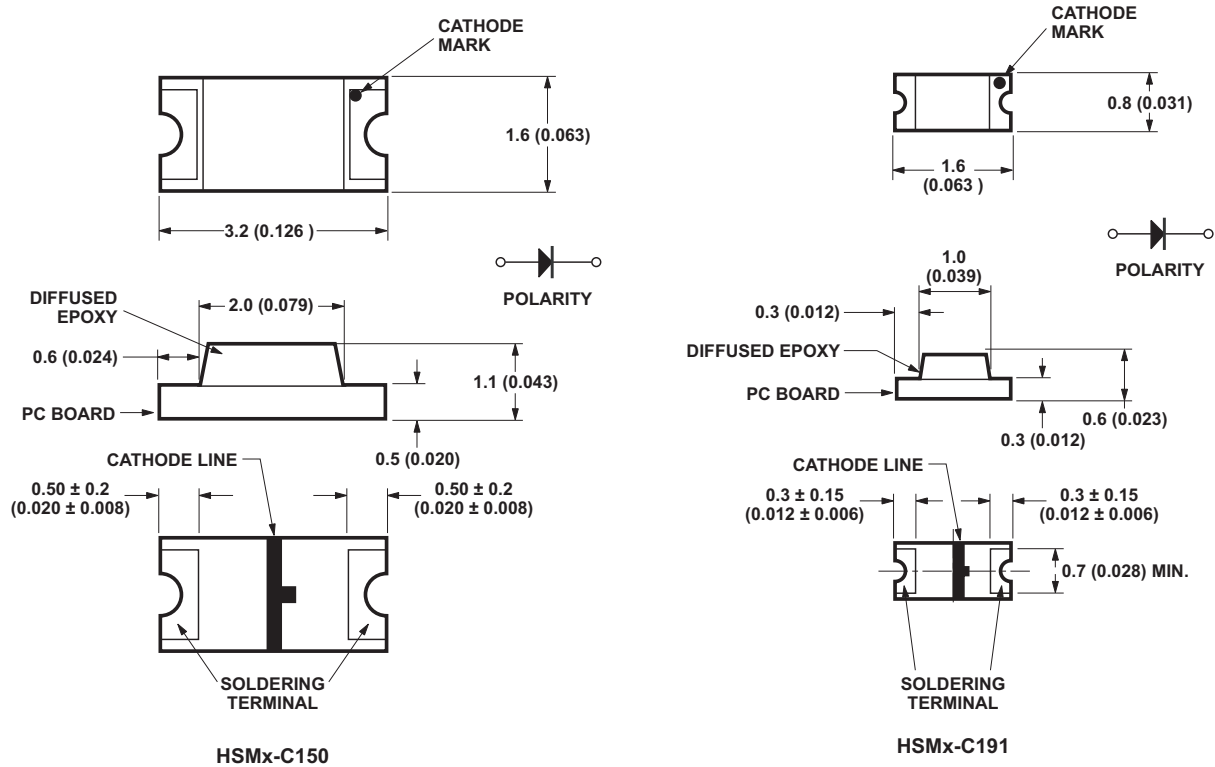

NOTES:

- All dimensions in millimeters (inches).
- Tolerance is ± 0.1 mm (± 0.004 in.) unless otherwise specified.

Absolute Maximum Ratings at $T_A = 25^\circ\text{C}$

Parameter	HSMx-C110/C120/C170/C190/C150	Units
	HSMN-C110/C120/C170/C190/C191/C150	
DC Forward Current ^[1]	20	mA
Power Dissipation	78	mW
Reverse Voltage ($I_R = 100 \mu\text{A}$)	5	V
Led Junction Temperature	95	$^\circ\text{C}$
Operating Temperature Range	-40 to +85	$^\circ\text{C}$
Storage Temperature Range	-40 to +85	$^\circ\text{C}$
Soldering Temperature	See reflow soldering profile (Figure 7)	

Note:

- Derate linearly as shown in Figure 4.

Electrical Characteristics at $T_A = 25^\circ\text{C}$

Part Number	Forward Voltage V_F (Volts) @ $I_F = 20$ mA		Reverse Breakdown V_R (Volts) @ $I_R = 100 \mu\text{A}$	Capacitance C (pF), $V_F = 0$, $f = 1$ MHz	Thermal Resistance $R_{\theta J-PIN}$ ($^\circ\text{C}/\text{W}$)
	Typ.	Max.	Min.	Typ.	Typ.
HSMx-C110/C150	3.3	3.9	5	70	450
HSMN-C110/C150	3.3	3.9	5	70	450
HSMx-C120	3.3	3.9	5	45	450
HSMN-C120	3.3	3.9	5	45	450
HSMx-C170/C190	3.3	3.9	5	70	300
HSMN-C170/C190/C191	3.3	3.9	5	70	300

V_F Tolerance: ± 0.1 V.

Optical Characteristics at $T_A = 25^\circ\text{C}$

Part Number	Color	Luminous Intensity I_v (mcd) @ 20 mA ^[1]		Peak Wavelength λ_{peak} (nm) Typ.	Color, Dominant Wavelength λ_d ^[2] (nm) Typ.	Viewing Angle $2\theta_{1/2}$ Degrees ^[3] Typ.	Luminous Efficacy η_v (lm/w) Typ.
		Min.	Typ.				
HSMM-C110	Green	45	126	523	525	130	490
HSMM-C120	Green	45	120	523	525	155	490
HSMM-C170/C190/ /C150	Green	45	120	523	525	170	490
HSMN-C110	Blue	11.2	39	468	470	130	77
HSMN-C120	Blue	11.2	35	468	470	155	80
HSMN-C170/C190/ C191/C150	Blue	11.2	35	468	470	170	77

Notes:

1. The luminous intensity, I_v , is measured at the peak of the spatial radiation pattern which may not be aligned with the mechanical axis of the lamp package.
2. The dominant wavelength, λ_d , is derived from the CIE Chromaticity Diagram and represents the perceived color of the device.
3. $\theta_{1/2}$ is the off-axis angle where the luminous intensity is 1/2 the peak intensity.

Color Bin Limits^[1]

Bin ID	Blue Color Bins ^[1]	
	Dom. Wavelength (nm)	
	Min.	Max.
A	460.0	465.0
B	465.0	470.0
C	470.0	475.0
D	475.0	480.0

Tolerance: ± 1 nm

Bin ID	InGaN Green Color Bins ^[1]	
	Dom. Wavelength (nm)	
	Min.	Max.
A	515.0	520.0
B	520.0	525.0
C	525.0	530.0
D	530.0	535.0

Tolerance: ± 1 nm

Note:

1. Bin categories are established for classification of products. Products may not be available in all categories. Please contact your Avago representative for information on currently available bins.

Light Intensity (I_v) Bin Limits^[1]

Bin ID	Intensity (mcd)		Bin ID	Intensity (mcd)	
	Min.	Max.		Min.	Max.
A	0.11	0.18	N	28.50	45.00
B	0.18	0.29	P	45.00	71.50
C	0.29	0.45	Q	71.50	112.50
D	0.45	0.72	R	112.50	180.00
E	0.72	1.10	S	180.00	285.00
F	1.10	1.80	T	285.00	450.00
G	1.80	2.80	U	450.00	715.00
H	2.80	4.50	V	715.00	1125.00
J	4.50	7.20	W	1125.00	1800.00
K	7.20	11.20	X	1800.00	2850.00
L	11.20	18.00	Y	2850.00	4500.00
M	18.00	28.50			

Tolerance: $\pm 15\%$

Note:

1. Bin categories are established for classification of products. Products may not be available in all categories. Please contact your Avago representative for information on currently available bins.
2. The I_v binning specification set-up is for lowest allowable I_v binning only. There is no upper I_v bin limits.

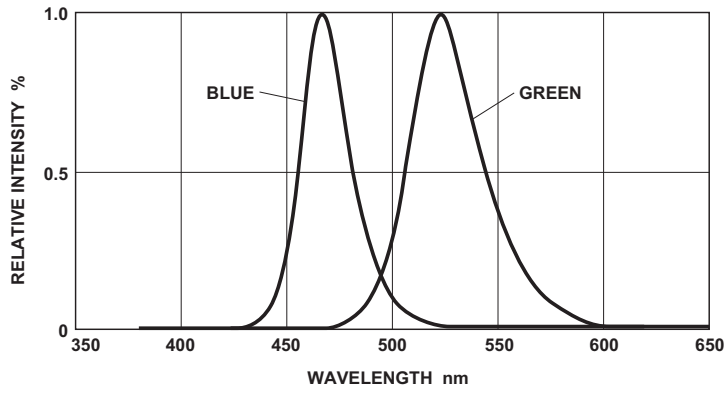

Figure 1. Relative intensity vs. wavelength.

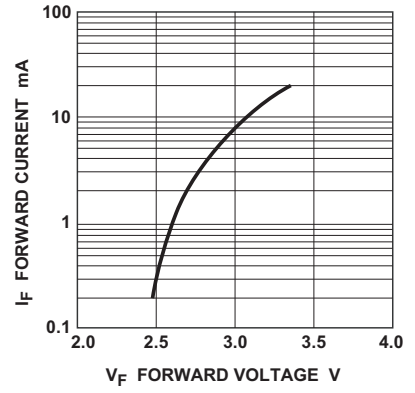

Figure 2. Forward current vs. forward voltage.

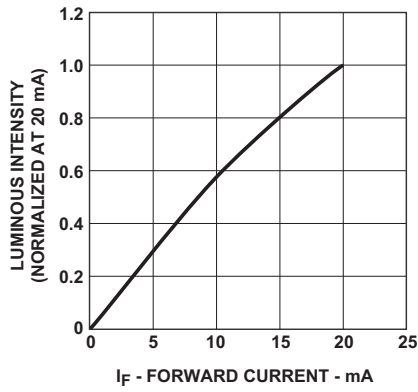

Figure 3. Luminous intensity vs. forward current.

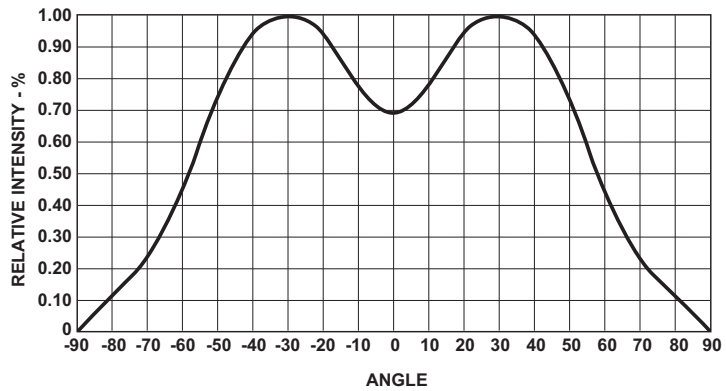
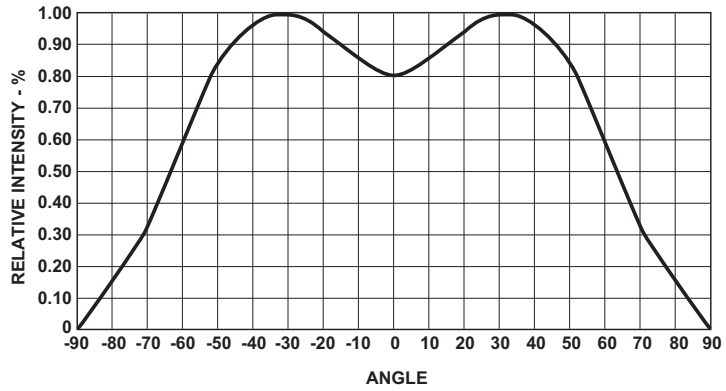

Figure 5. Relative intensity vs. angle for HSMx-C110.

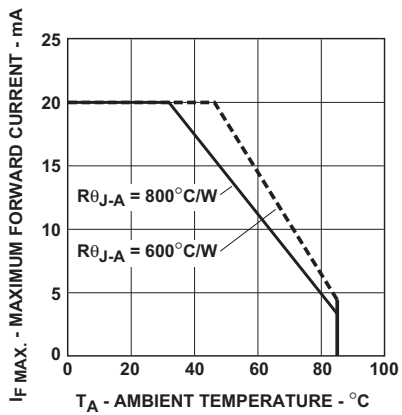

Figure 4. Maximum forward current vs. ambient temperature.

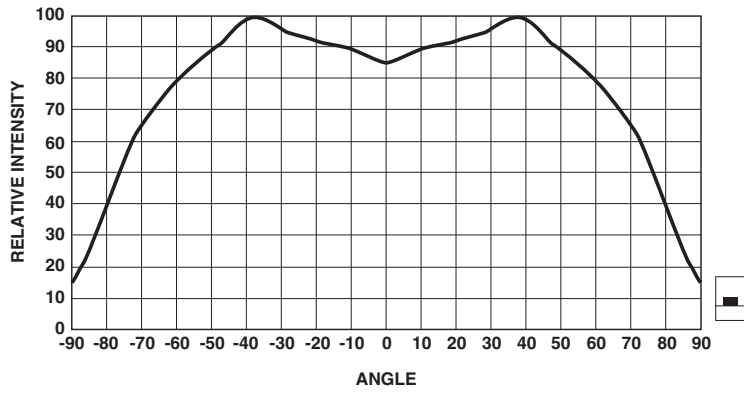
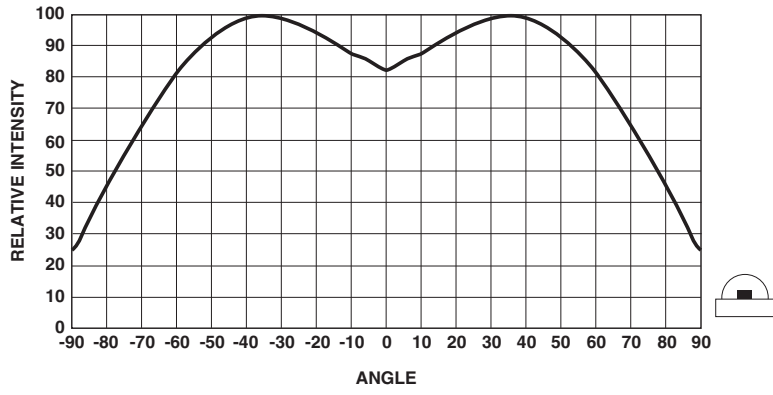

Figure 6. Relative intensity vs. angle for HSMx-C120

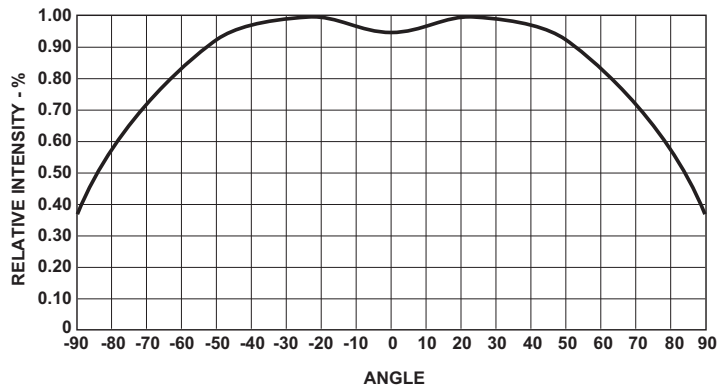

Figure 7. Relative intensity vs. angle for HSMx-C170, C190, C191, and C150.

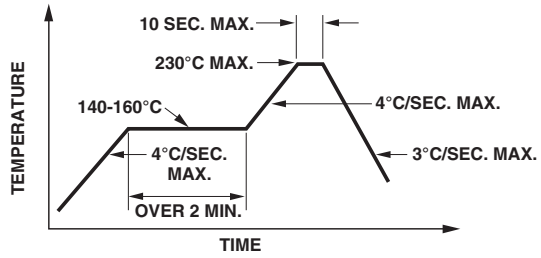

Figure 8. Recommended reflow soldering profile.

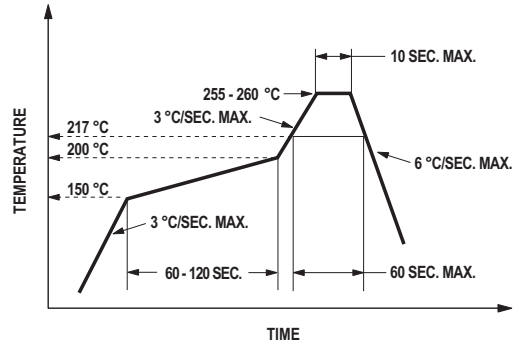

Figure 9. Recommended Pb-free reflow soldering profile.

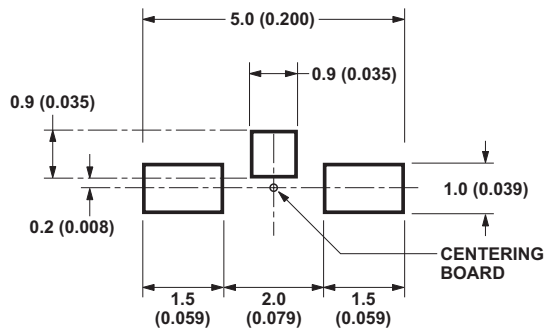

Figure 10. Recommended soldering pattern for HSMx-C110.

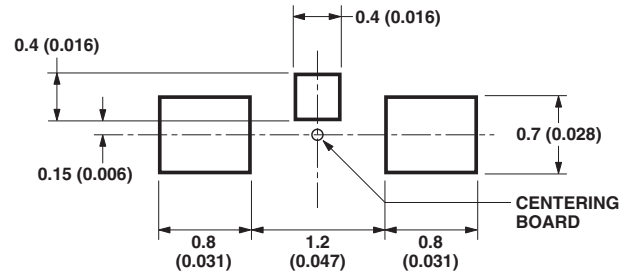

Figure 11. Recommended soldering pattern for HSMx-C120.

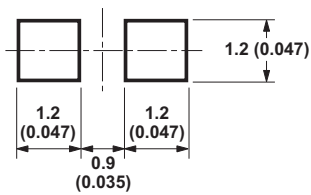

Figure 12. Recommended soldering pattern for HSMx-C170.

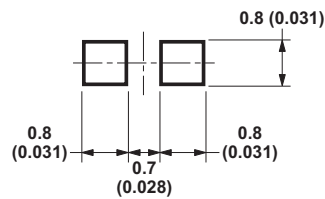

Figure 13. Recommended soldering pattern for HSMx-C190/C191

NOTE:

1. All dimensions in millimeters (inches).

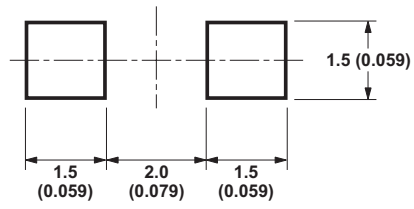

Figure 14. Recommended soldering pattern for HSMx-C150.

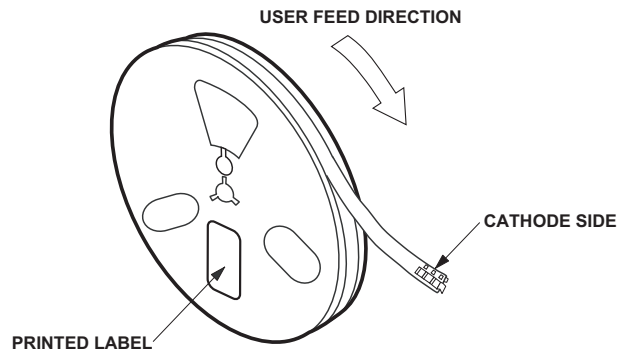
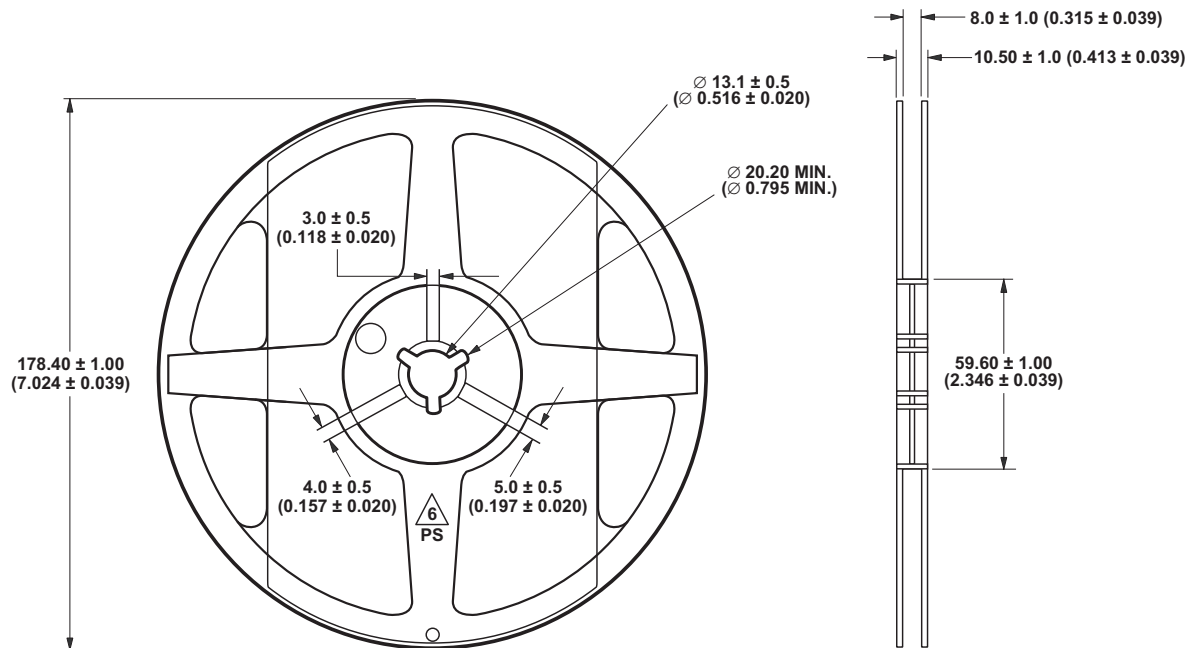

Figure 15. Reeling orientation.



NOTE:

1. All dimensions in millimeters (inches).

Figure 16. Reel dimensions.

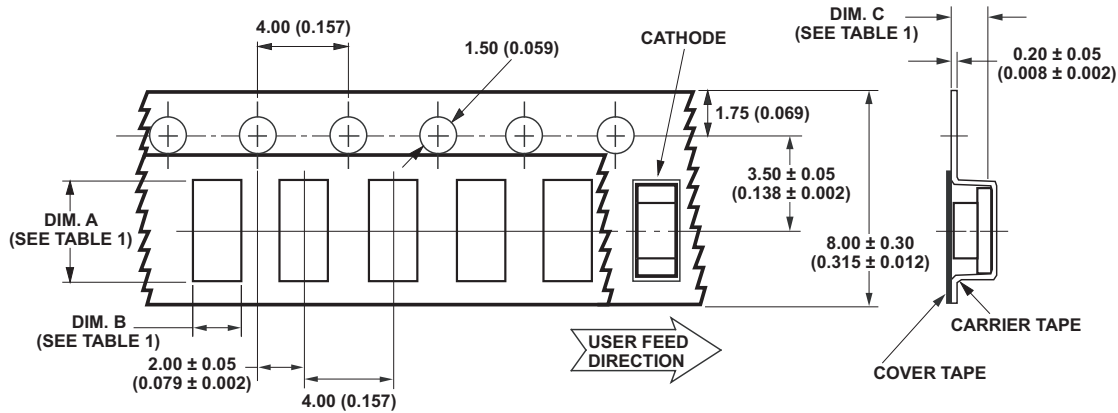

TABLE 1
DIMENSIONS IN MILLIMETERS (INCHES)

PART NUMBER	DIM. A ± 0.10 (± 0.004)	DIM. B ± 0.10 (± 0.004)	DIM. C ± 0.10 (± 0.004)
HSMx-C191 SERIES	1.85 (0.073)	0.88 (0.035)	0.85 (0.033)
HSMx-C190 SERIES	1.75 (0.069)	0.90 (0.035)	0.90 (0.035)
HSMx-C170 SERIES	2.30 (0.091)	1.45 (0.057)	0.95 (0.037)
HSMx-C110 SERIES	3.40 (0.134)	1.70 (0.067)	1.20 (0.047)
HSMx-C120 SERIES	1.90 (0.075)	1.15 (0.045)	0.75 (0.030)
HSMx-C150 SERIES	3.50 (0.138)	1.88 (0.074)	1.27 (0.050)

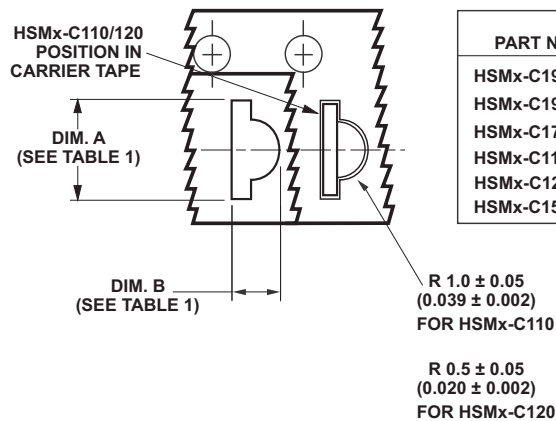
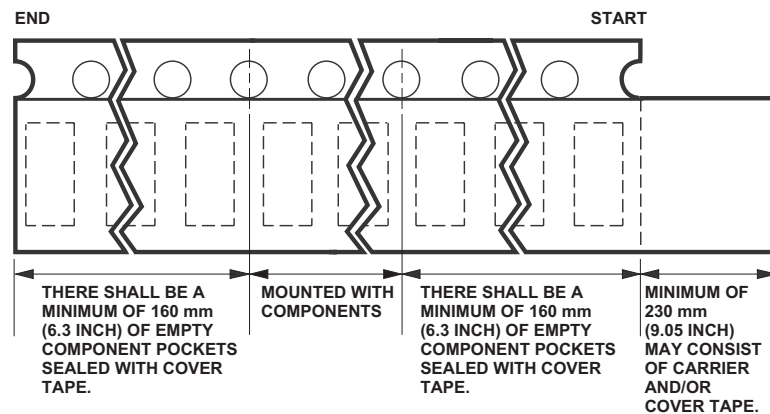

Figure 17. Tape dimensions.



NOTES:
1. All dimensions in millimeters (inches).
2. Tolerance is ± 0.1 mm (± 0.004 in.) unless otherwise specified.

Figure 18. Tape leader and trailer dimensions.

Reflow Soldering:

For more information on reflow soldering, refer to Application Note AN-1060, Surface Mounting SMT LED Indicator Components.

Storage Condition:

5 to 30°C @ 60%RH max.

Baking is required before mounting, if:

1. Humidity Indicator Card is > 10% when read at 23 ± 5°C.
2. Device expose to factory conditions <30°C/60%RH more than 672 hours.

Recommended baking condition:

60±5°C for 20 hours.

For product information and a complete list of distributors, please go to our web site: www.avagotech.com

Avago, Avago Technologies, and the A logo are trademarks of Avago Technologies in the United States and other countries. Data subject to change. Copyright © 2005-2010 Avago Technologies. All rights reserved. AV02-0592EN - May 5, 2010

