

IRS2111(S)PbF

HALF-BRIDGE DRIVER

Features

- Floating channel designed for bootstrap operation
- Fully operational to +600 V
- Tolerant to negative transient voltage, dV/dt immune
- Gate drive supply range from 10 V to 20 V
- Undervoltage lockout for both channels
- CMOS Schmitt-triggered inputs with pull-down
- Matched propagation delay for both channels
- Internally set deadtime
- High-side output in phase with input
- RoHS compliant

Product Summary

| | |
|----------------------------|-----------------|
| V_{OFFSET} | 600 V max. |
| $I_{\text{O}+/-}$ | 200 mA / 420 mA |
| V_{OUT} | 10 V - 20 V |
| $t_{\text{on/off}}$ (typ.) | 750 ns & 150 ns |
| Deadtime (typ.) | 650 ns |

Description

The IRS2111 is a high voltage, high speed power MOSFET and IGBT driver with dependent high-side and low-side referenced output channels designed for half-bridge applications. Proprietary HVIC and latch immune CMOS technologies enable ruggedized monolithic construction. Logic input is compatible with standard CMOS outputs. The output drivers feature a high pulse current buffer stage designed for minimum driver cross-conduction. Internal deadtime is provided to avoid shoot-through in the output half-bridge. The floating channel can be used to drive an N-channel power MOSFET or IGBT in the high-side configuration which operates up to 600 V.

Packages

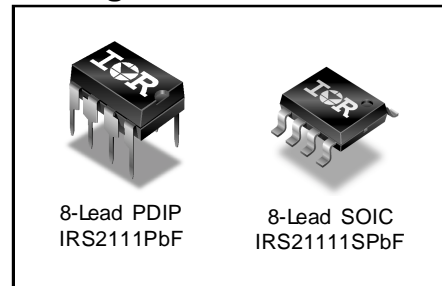

Typical Connection

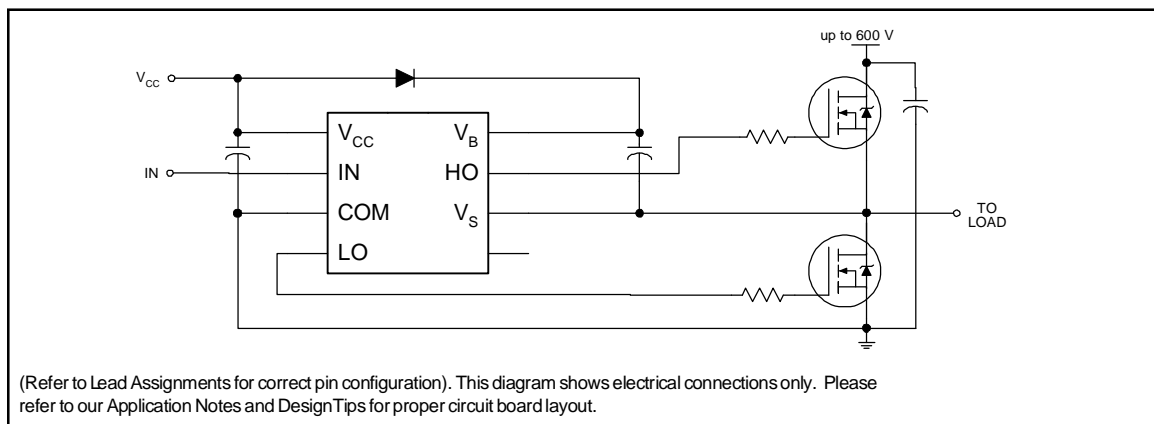

Absolute Maximum Ratings

Absolute maximum ratings indicate sustained limits beyond which damage to the device may occur. All voltage parameters are absolute voltages referenced to COM. The thermal resistance and power dissipation ratings are measured under board mounted and still air conditions. Additional information is shown in Figs. 7 through 10.

| Symbol | Definition | Min. | Max. | Units | |
|------------|--|---------------|----------------|------------------|---------------------------|
| V_B | High-side floating supply voltage | -0.3 | 625 (Note 1) | V | |
| V_S | High-side floating supply offset voltage | $V_B - 25$ | $V_B + 0.3$ | | |
| V_{HO} | High-side floating output voltage | $V_S - 0.3$ | $V_B + 0.3$ | | |
| V_{CC} | Low-side and logic fixed supply voltage | -0.3 | 25 (Note 1) | | |
| V_{LO} | Low-side output voltage | -0.3 | $V_{CC} + 0.3$ | | |
| V_{IN} | Logic input voltage | -0.3 | $V_{CC} + 0.3$ | | |
| dV_S/dt | Allowable offset supply voltage transient (Fig. 2) | — | 50 | V/ns | |
| P_D | Package power dissipation @ $T_A \leq +25\text{ }^\circ\text{C}$ | (8 Lead PDIP) | — | 1.0 | W |
| | | (8 lead SOIC) | — | 0.625 | |
| R_{thJA} | Thermal resistance, junction to ambient | (8 lead PDIP) | — | 125 | $^\circ\text{C}/\text{W}$ |
| | | (8 lead SOIC) | — | 200 | |
| T_J | Junction temperature | — | 150 | $^\circ\text{C}$ | |
| T_S | Storage temperature | -55 | 150 | | |
| T_L | Lead temperature (soldering, 10 seconds) | — | 300 | | |

Note 1: All supplies are fully tested at 25 V, and an internal 20 V clamp exists for each supply

Recommended Operating Conditions

The input/output logic timing diagram is shown in Fig. 1. For proper operation the device should be used within the recommended conditions. The V_S offset rating is tested with all supplies biased at a 15 V differential.

| Symbol | Definition | Min. | Max. | Units |
|----------|--|------------|------------|------------------|
| V_B | High-side floating supply absolute voltage | $V_S + 10$ | $V_S + 20$ | V |
| V_S | High-side floating supply offset voltage | Note 2 | 600 | |
| V_{HO} | High-side floating output voltage | V_S | V_B | |
| V_{CC} | Low-side and logic fixed supply voltage | 10 | 20 | |
| V_{LO} | Low-side output voltage | 0 | V_{CC} | |
| V_{IN} | Logic input voltage | 0 | V_{CC} | |
| T_A | Ambient temperature | -40 | 125 | $^\circ\text{C}$ |

Note 2: Logic operational for V_S of -5 V to +600 V. Logic state held for V_S of -5 V to $-V_{BS}$. (Please refer to the Design Tip DT97-3 for more details).

Dynamic Electrical Characteristics

V_{BIAS} (V_{CC} , V_{BS}) = 15 V, C_L = 1000 pF and T_A = 25 °C unless otherwise specified. The dynamic electrical characteristics are measured using the test circuit shown in Fig. 3.

| Symbol | Definition | Min. | Typ. | Max. | Units | Test Conditions |
|-----------|---|------|------|------|-------|-----------------|
| t_{on} | Turn-on propagation delay | 550 | 750 | 950 | ns | $V_S = 0$ V |
| t_{off} | Turn-off propagation delay | — | 150 | 180 | | $V_S = 600$ V |
| t_r | Turn-on rise time | — | 75 | 130 | | |
| t_f | Turn-off fall time | — | 35 | 65 | | |
| DT | Deadtime, LS turn-off to HS turn-on & HS turn-off to LS turn-on | 480 | 650 | 820 | | |
| MT | Delay matching, HS & LS turn-on/off | — | 30 | — | | |

Static Electrical Characteristics

V_{BIAS} (V_{CC} , V_{BS}) = 15 V and T_A = 25 °C unless otherwise specified. The V_{IN} , V_{TH} , and I_{IN} parameters are referenced to COM. The V_O and I_O parameters are referenced to COM and are applicable to the respective output leads: HO or LO.

| Symbol | Definition | Min. | Typ. | Max. | Units | Test Conditions | |
|-------------|---|------|------|------|----------------------------|--|---------------------|
| V_{IH} | Logic "1" input voltage for HO & logic "0" for LO | 6.4 | — | — | V | $V_{CC} = 10$ V | |
| | | 9.5 | — | — | | $V_{CC} = 15$ V | |
| | | 12.6 | — | — | | $V_{CC} = 20$ V | |
| V_{IL} | Logic "0" input voltage for HO & logic "1" for LO | — | — | 3.8 | | $V_{CC} = 10$ V | |
| | | — | — | 6.0 | | $V_{CC} = 15$ V | |
| | | — | — | 8.3 | | $V_{CC} = 20$ V | |
| V_{OH} | High level output voltage, $V_{BIAS} - V_O$ | — | 0.05 | 0.2 | | | $I_O = 2$ mA |
| V_{OL} | Low level output voltage, V_O | — | 0.02 | 0.1 | | | |
| I_{LK} | Offset supply leakage current | — | — | 50 | | μ A | $V_B = V_S = 600$ V |
| I_{QBS} | Quiescent V_{BS} supply current | — | 50 | 100 | $V_{IN} = 0$ V or V_{CC} | | |
| I_{QCC} | Quiescent V_{CC} supply current | — | 70 | 180 | $V_{IN} = V_{CC}$ | | |
| I_{IN+} | Logic "1" input bias current | — | 30 | 50 | $V_{IN} = 0$ V | | |
| I_{IN-} | Logic "0" input bias current | — | — | 5.0 | | | |
| V_{BSUV+} | V_{BS} supply undervoltage positive going threshold | 7.6 | 8.6 | 9.6 | V | | |
| V_{BSUV-} | V_{BS} supply undervoltage negative going threshold | 7.2 | 8.2 | 9.2 | | | |
| V_{CCUV+} | V_{CC} supply undervoltage positive going threshold | 7.6 | 8.6 | 9.6 | | | |
| V_{CCUV-} | V_{CC} supply undervoltage negative going threshold | 7.2 | 8.2 | 9.2 | | | |
| I_{O+} | Output high short circuit pulsed current | 200 | 290 | — | mA | $V_O = 0$ V, $V_{IN} = V_{CC}$ $PW \leq 10$ μ s | |
| I_{O-} | Output low short circuit pulsed current | 420 | 600 | — | | $V_O = 15$ V, $V_{IN} = 0$ V $PW \leq 10$ μ s | |

Functional Block Diagram

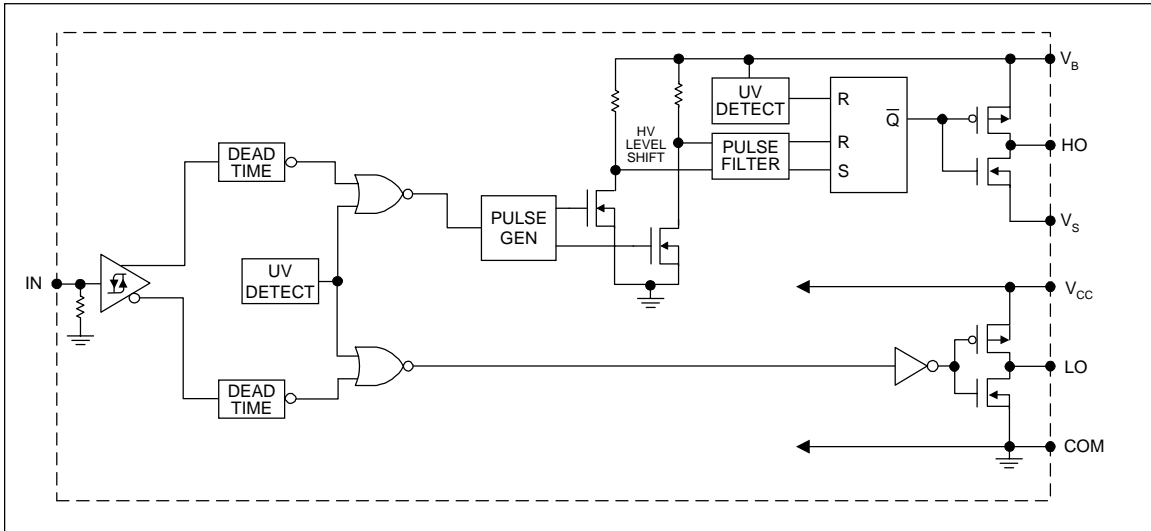

Lead Definitions

| Symbol | Description |
|-----------------|--|
| IN | Logic input for high-side and low-side gate driver outputs (HO & LO), in phase with HO |
| V _B | High-side floating supply |
| HO | High-side gate drive output |
| V _S | High-side floating supply return |
| V _{CC} | Low-side and logic fixed supply |
| LO | Low-side gate drive output |
| COM | Low-side return |

Lead Assignments

| | |
|---|---|
| <p>8 Lead DIP</p> <p>IRS2111</p> | <p>8 Lead SOIC</p> <p>IRS2111S</p> |
| Part Number | |

IRS2111(S)PbF

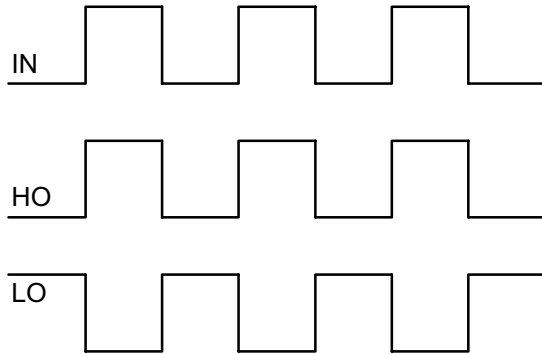

Figure 1. Input/Output Timing Diagram

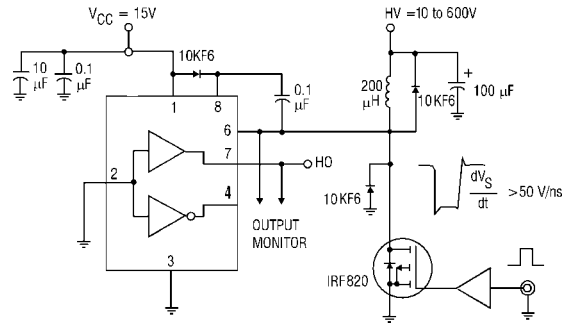

Figure 2. Floating Supply Voltage Transient Test Circuit

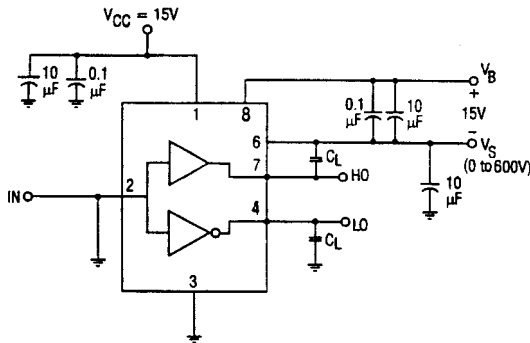

Figure 3. Switching Time Test Circuit

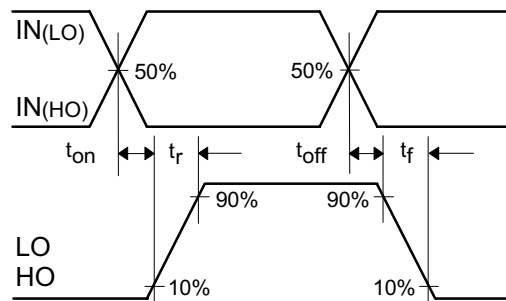

Figure 4. Switching Time Waveform Definition

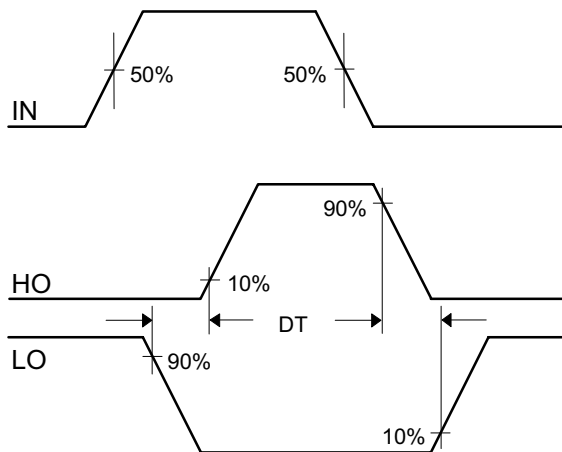

Figure 5. Deadtime Waveform Definitions

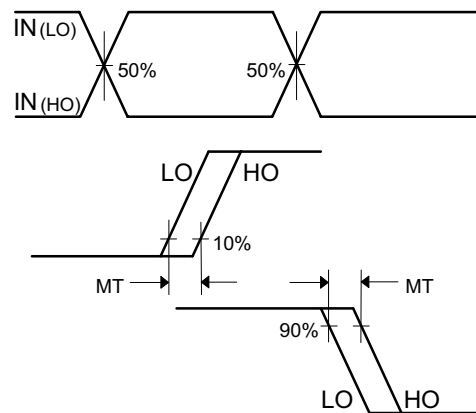

Figure 6. Delay Matching Waveform Definitions

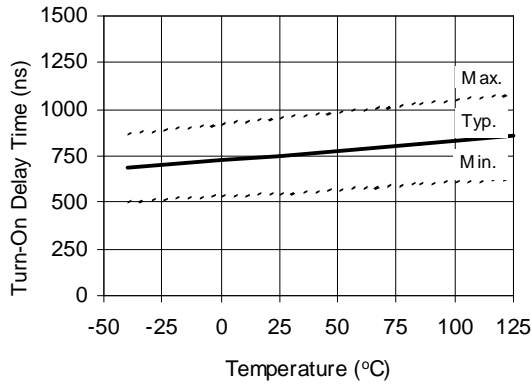

Figure 7A Turn-On Time vs Temperature

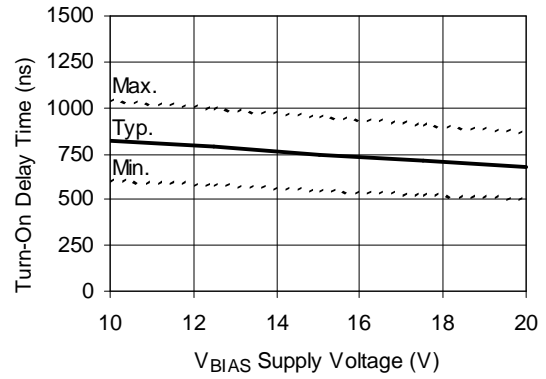

Figure 7B Turn-On Time vs Voltage

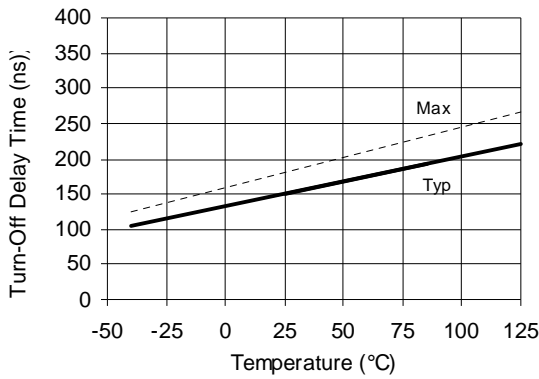

Figure 8A Turn-Off Time vs Temperature

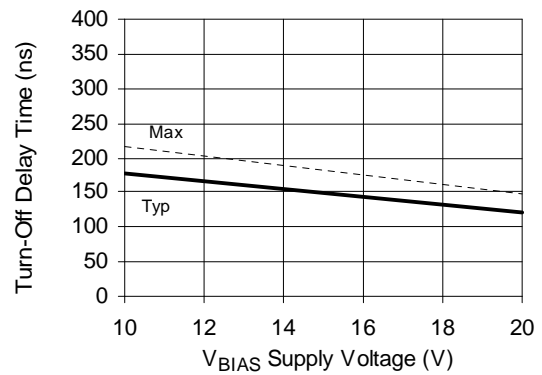

Figure 8B Turn-Off Time vs Voltage

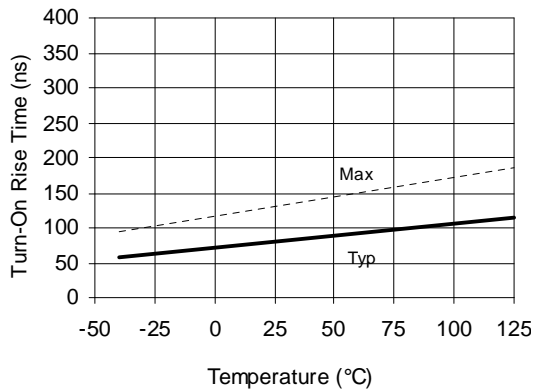

Figure 9A Turn-On Rise Time vs Temperature

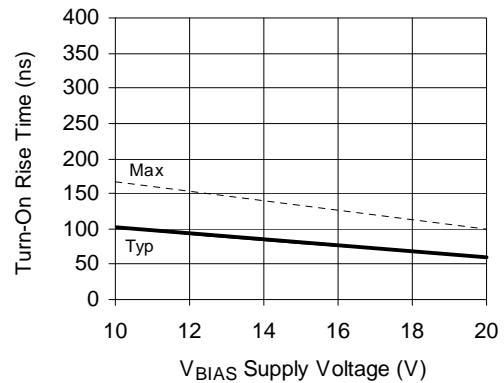

Figure 9B Turn-On Rise Time vs Voltage

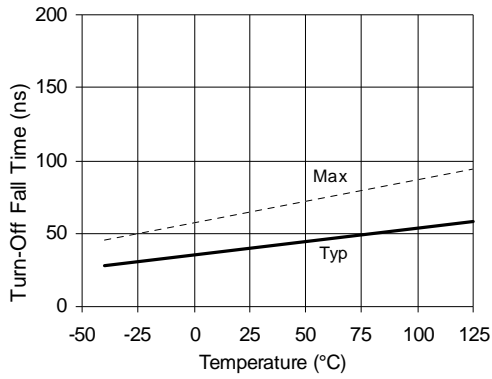

Figure 10A Turn-Off Fall Time vs Temperature

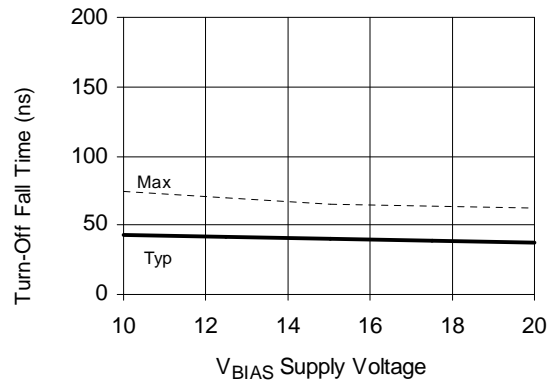

Figure 10B Turn-Off Fall Time vs Voltage

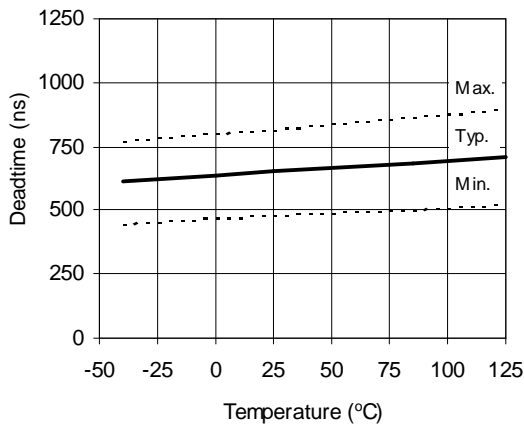

Figure 11A Deadtime vs Temperature

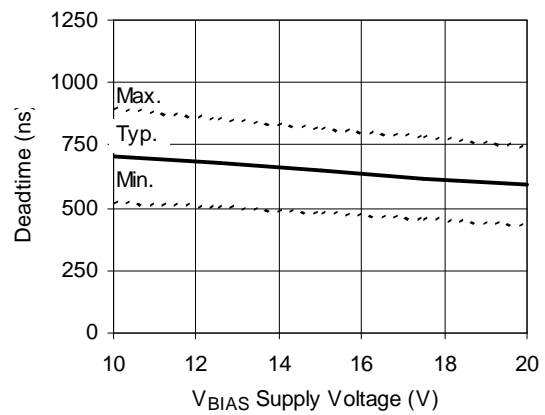

Figure 11B Deadtime vs Voltage

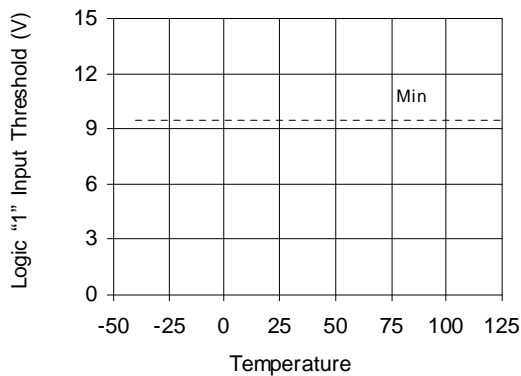

Figure 12A Logic "1" Input voltage for HO & Logic "0" for LO vs Temperature

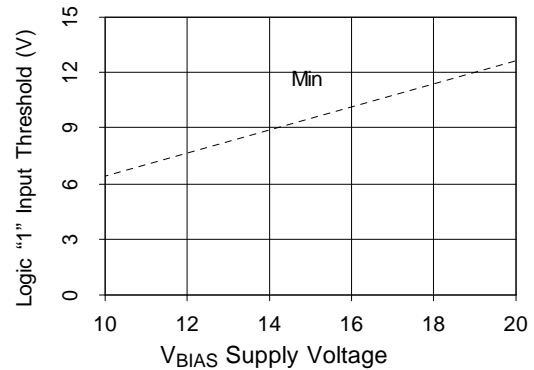

Figure 12B Logic "1" Input voltage for HO & Logic "0" for LO vs Voltage

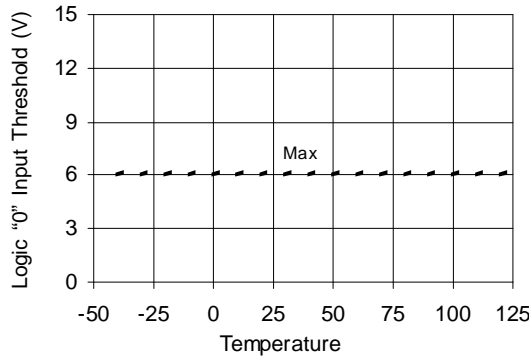

Figure 13A Logic "0" Input voltage for HO & Logic "1" for LO vs Temperature

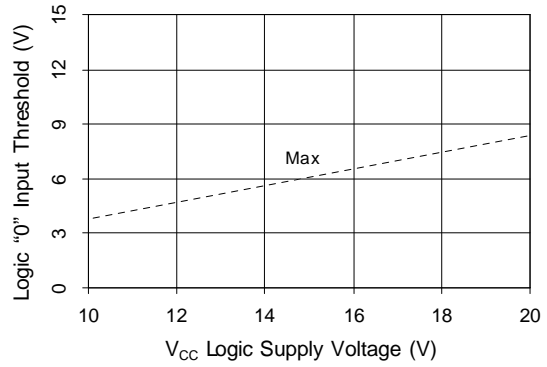

Figure 13B Logic "0" Input voltage for HO & Logic "1" for LO vs Voltage

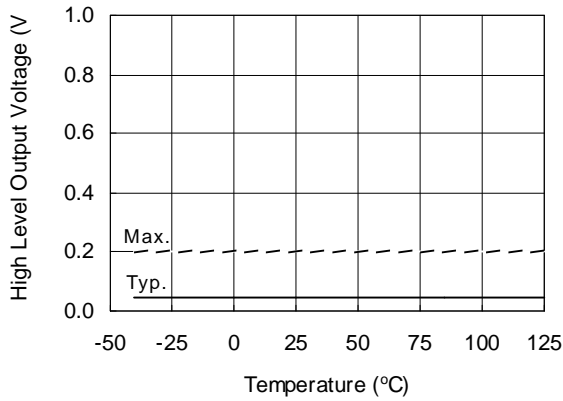

Figure 14A. High Level Output vs. Temperature

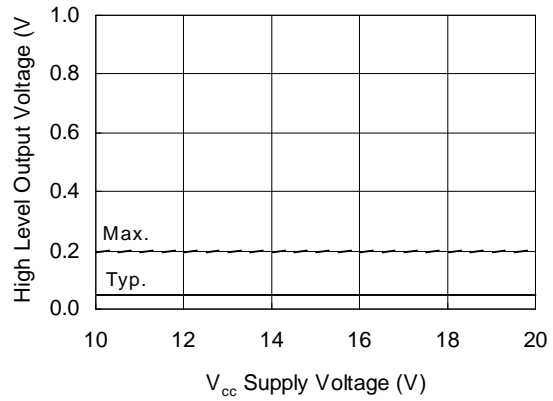

Figure 14B. High Level Output vs. Supply Voltage

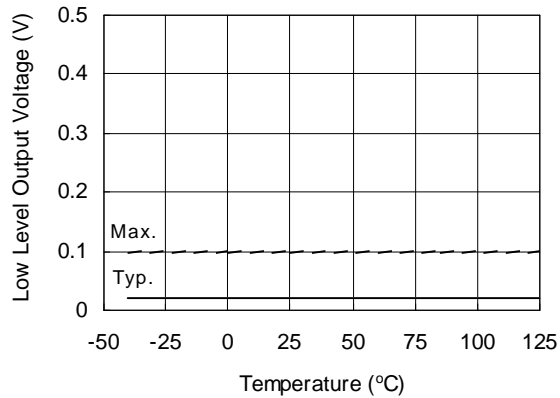

Figure 15A. Low Level Output vs. Temperature

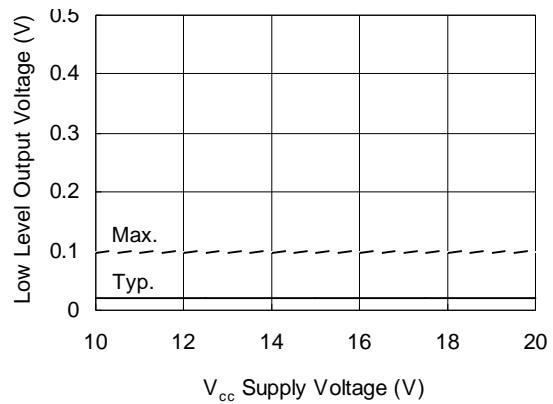

Figure 15B. Low Level Output vs. Voltage

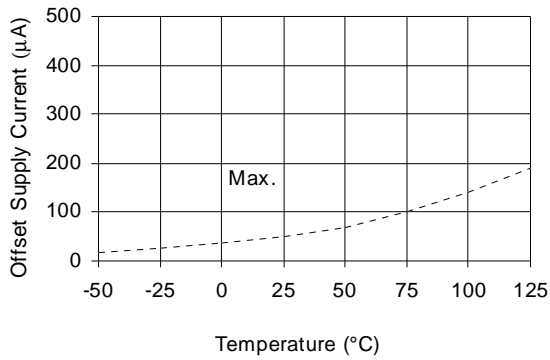

Figure 16A Offset Supply Current vs Temperature

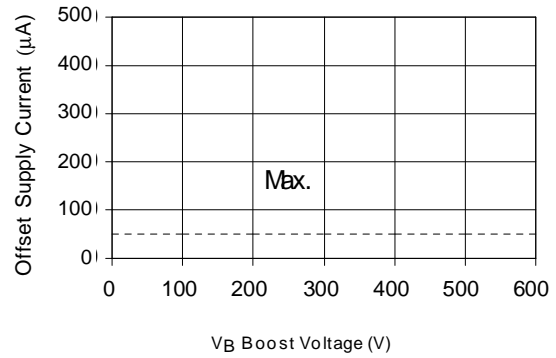

Figure 16B Offset Supply Current vs Voltage

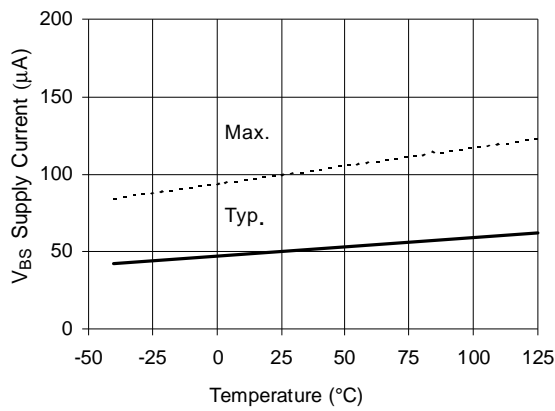

Figure 17A V_{BS} Supply Current vs Temperature

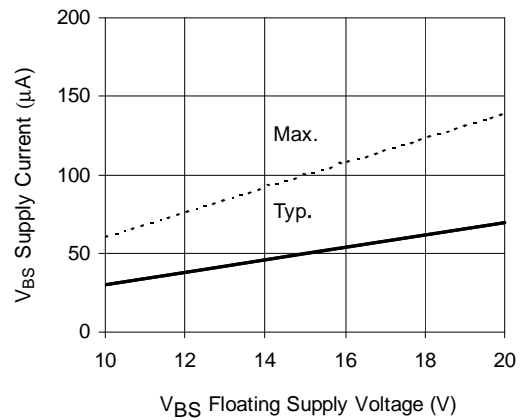

Figure 17B V_{BS} Supply Current vs Voltage

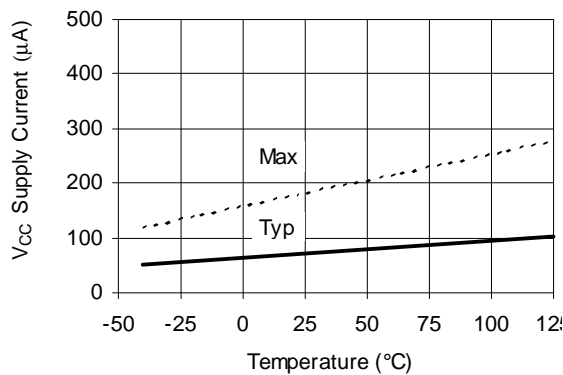

Figure 18A V_{CC} Supply Current vs Temperature

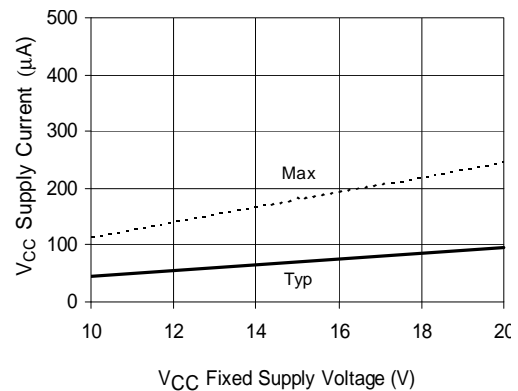

Figure 18B V_{CC} Supply Current vs Voltage

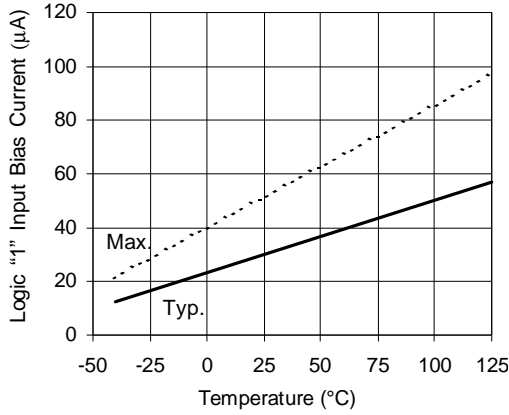

Figure 19A Logic "1" Input Current vs. Temperature

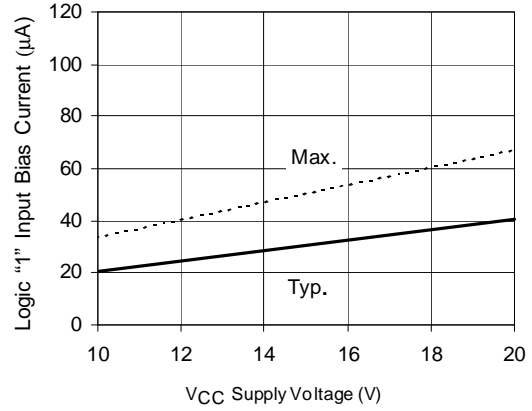

Figure 19B Logic "1" Input Current vs. Vcc Voltage

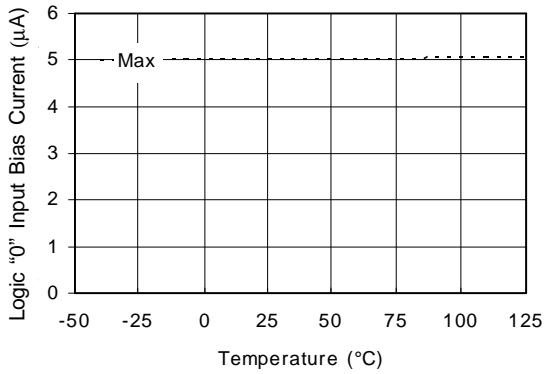

Figure 20A. Logic "0" Input Bias Current vs. Temperature

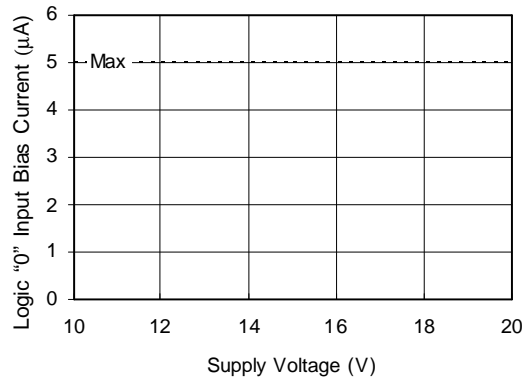

Figure 20B. Logic "0" Input Bias Current vs. Vcc Voltage

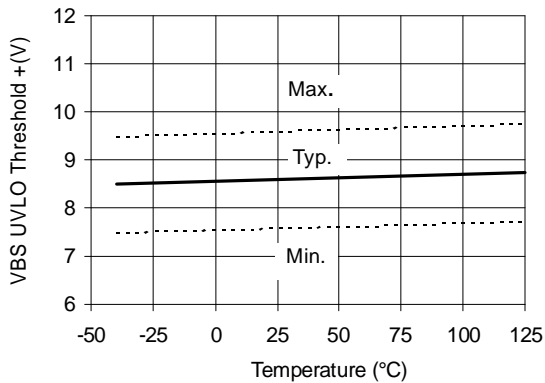

Figure 21 VBS Undervoltage Threshold (+) vs. Temperature

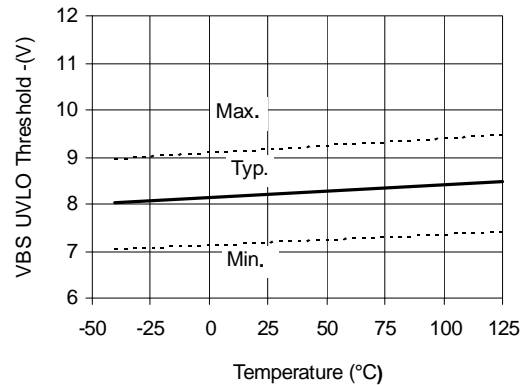

Figure 22 VBS Undervoltage Threshold (-) vs. Temperature

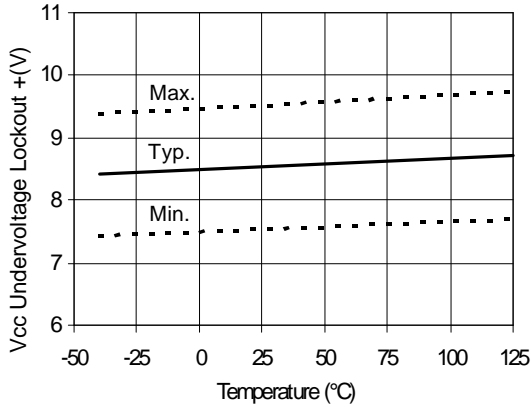

Figure 23 V_{CC} Undervoltage (-) vs Temperature

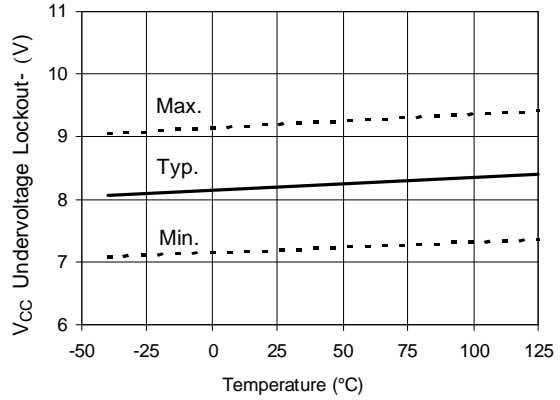

Figure 24 V_{CC} Undervoltage (-) vs Temperature

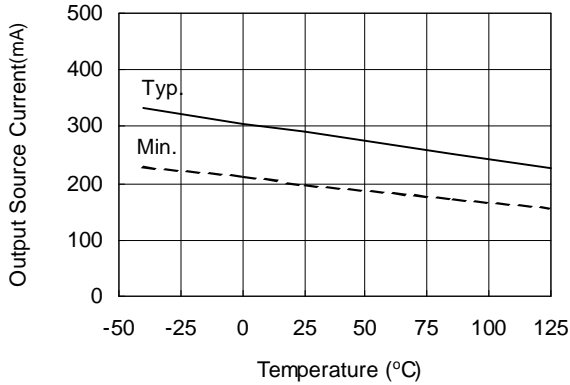

Figure 25A Output Source Current vs Temperature

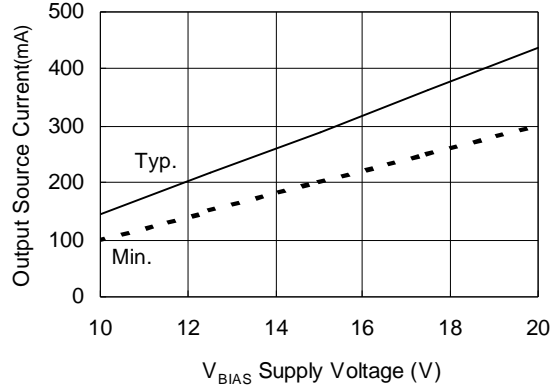

Figure 25B Output Source Current vs Voltage

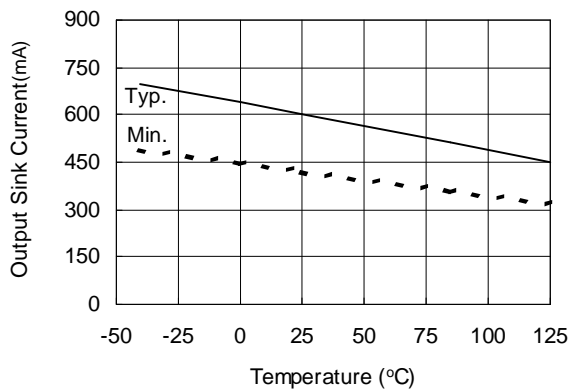

Figure 26A Output Sink Current vs Temperature

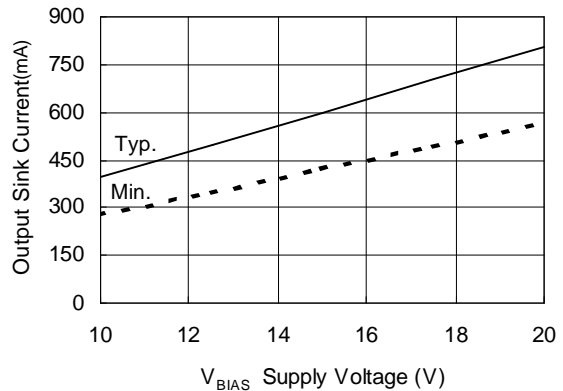

Figure 26B Output Sink Current vs Voltage

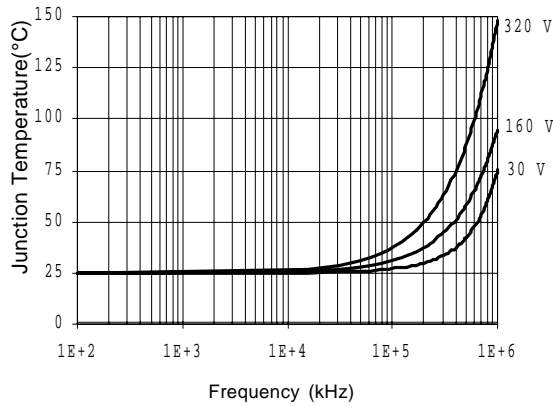

Figure 27. IRS2111 TJ vs. Frequency (IRFBC20)
R_{GATE} = 33 Ω, V_{CC} = 15 V

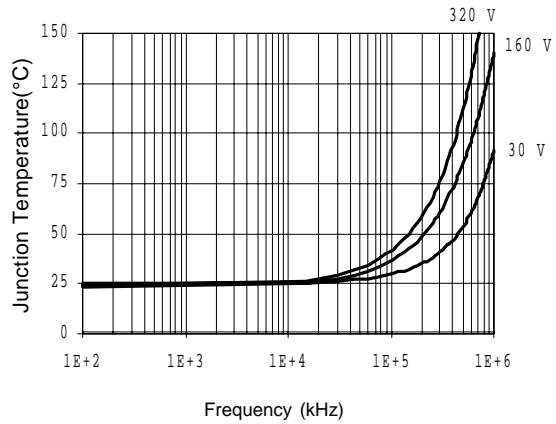

Figure 28. IRS2111 TJ vs. Frequency (IRFBC30)
R_{GATE} = 22 Ω, V_{CC} = 15 V

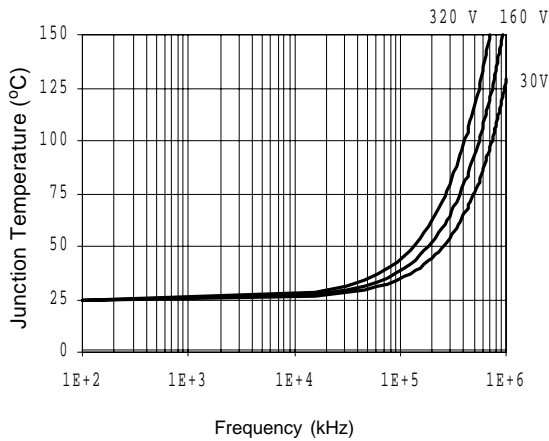

Figure 29. IRS2111 TJ vs. Frequency (IRFBC40)
R_{GATE} = 15 Ω, V_{CC} = 15 V

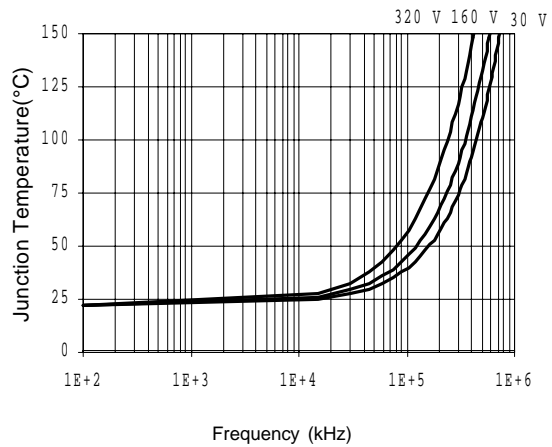

Figure 30. IRS2111 TJ vs. Frequency (IRFPC50)
R_{GATE} = 10 Ω, V_{CC} = 15 V

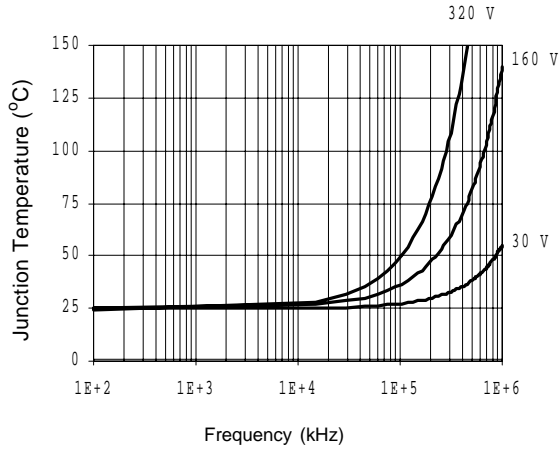

Figure 31. IRS2111S TJ vs. Frequency (IRFBC20)
 $R_{GATE} = 33 \Omega, V_{CC} = 15 V$

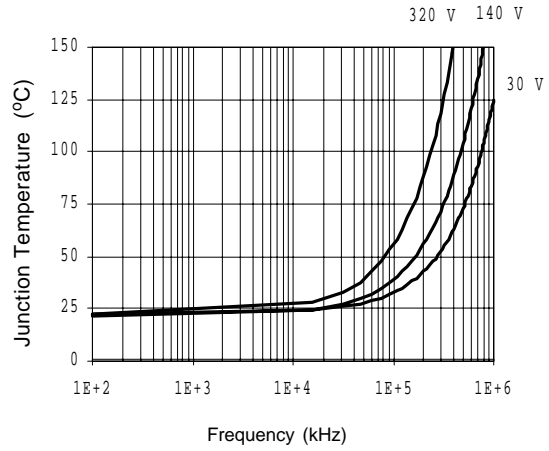

Figure 32. IRS2111S TJ vs. Frequency (IRFBC30)
 $R_{GATE} = 22 \Omega, V_{CC} = 15 V$

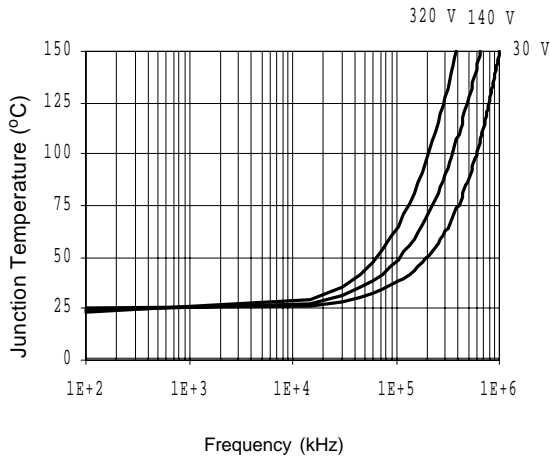

Figure 33. IRS2111S TJ vs. Frequency (IRFBC40)
 $R_{GATE} = 15 \Omega, V_{CC} = 15 V$

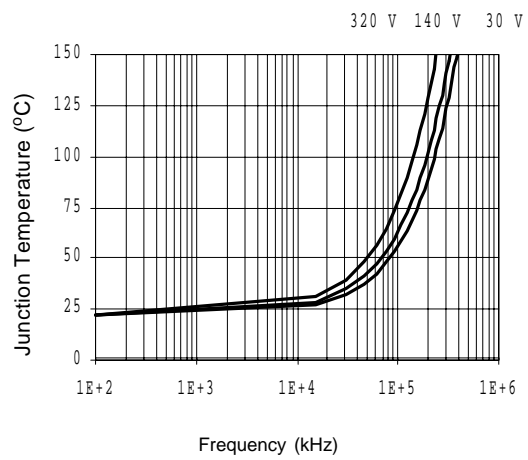
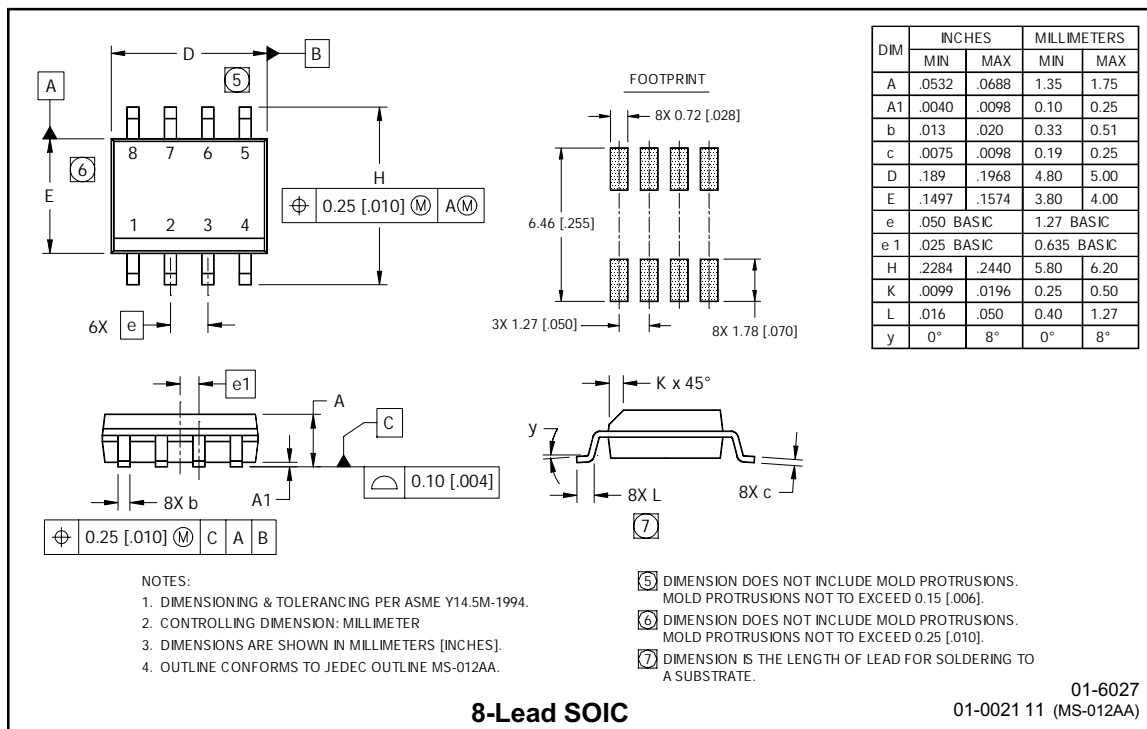
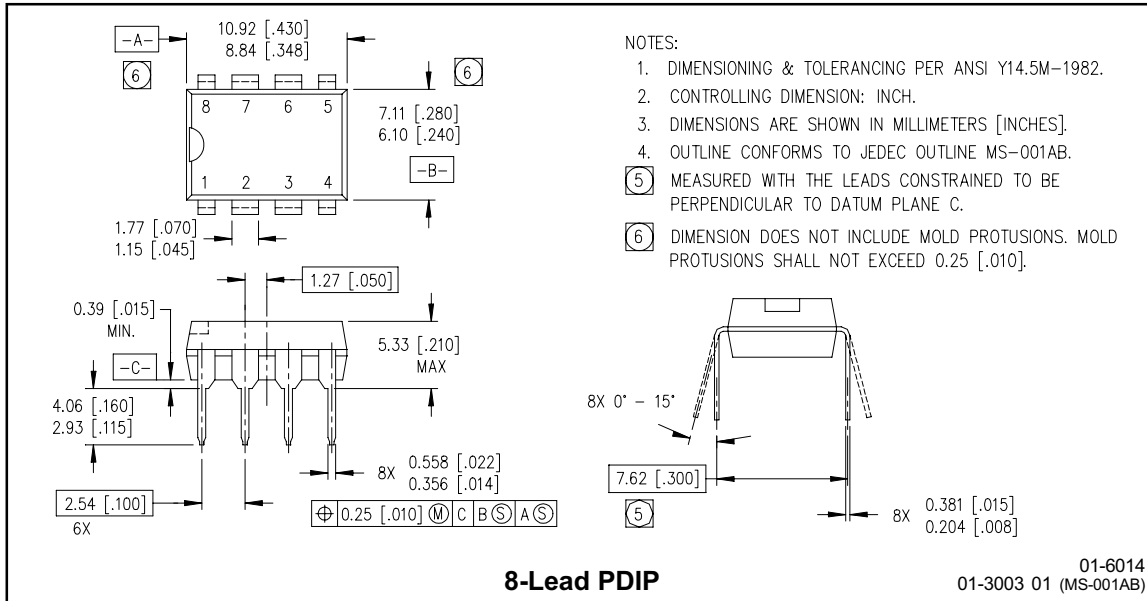
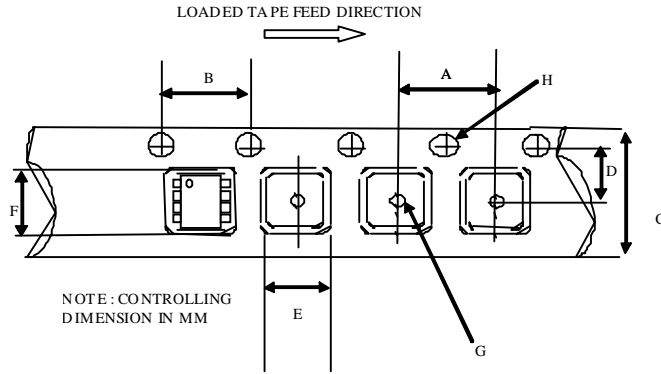

Figure 34. IRS2111S TJ vs. Frequency (IRFPC50)
 $R_{GATE} = 10 \Omega, V_{CC} = 15 V$

Case outlines



**Tape & Reel
8-lead SOIC**



CARRIER TAPE DIMENSION FOR 8SOICN

| Code | Metric | | Imperial | |
|------|--------|-------|----------|-------|
| | Min | Max | Min | Max |
| A | 7.90 | 8.10 | 0.311 | 0.318 |
| B | 3.90 | 4.10 | 0.153 | 0.161 |
| C | 11.70 | 12.30 | 0.46 | 0.484 |
| D | 5.45 | 5.55 | 0.214 | 0.218 |
| E | 6.30 | 6.50 | 0.248 | 0.255 |
| F | 5.10 | 5.30 | 0.200 | 0.208 |
| G | 1.50 | n/a | 0.059 | n/a |
| H | 1.50 | 1.60 | 0.059 | 0.062 |

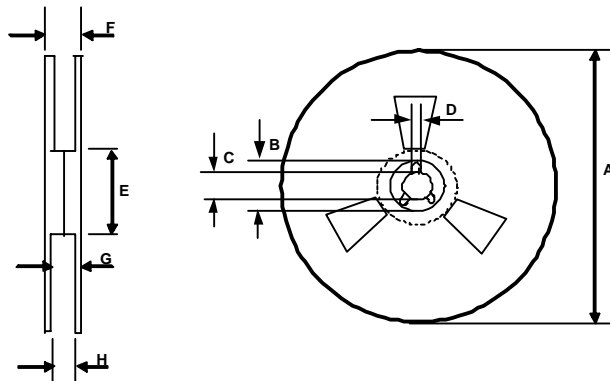

REEL DIMENSIONS FOR 8SOICN

| Code | Metric | | Imperial | |
|------|--------|--------|----------|--------|
| | Min | Max | Min | Max |
| A | 329.60 | 330.25 | 12.976 | 13.001 |
| B | 20.95 | 21.45 | 0.824 | 0.844 |
| C | 12.80 | 13.20 | 0.503 | 0.519 |
| D | 1.95 | 2.45 | 0.767 | 0.096 |
| E | 98.00 | 102.00 | 3.858 | 4.015 |
| F | n/a | 18.40 | n/a | 0.724 |
| G | 14.50 | 17.10 | 0.570 | 0.673 |
| H | 12.40 | 14.40 | 0.488 | 0.566 |

LEADFREE PART MARKING INFORMATION

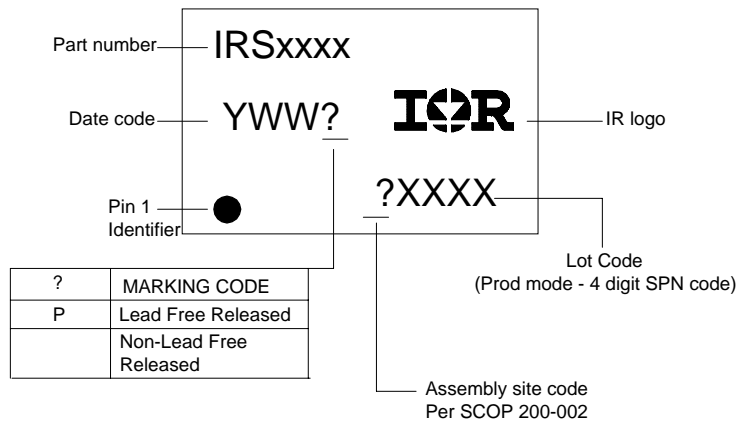

ORDER INFORMATION

- 8-Lead PDIP IRS2111PbF
- 8-Lead SOIC IRS2111SPbF
- 8-Lead SOIC Tape & Reel IRS2111STRPbF

Mouser Electronics

Authorized Distributor

Click to View Pricing, Inventory, Delivery & Lifecycle Information:

[International Rectifier:](#)

[IRS2111PBF](#) [IRS2111STRPBF](#) [IRS2111SPbF](#)