

High Speed IGBT with Diode

IXSA 10N60B2D1 IXSP 10N60B2D1

$$V_{CES} = 600 \text{ V}$$

$$I_{C25} = 20 \text{ A}$$

$$V_{CE(sat)} = 2.5 \text{ V}$$

Short Circuit SOA Capability

Preliminary Data Sheet

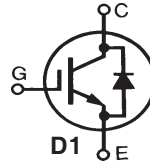

Symbol	Test Conditions	Maximum Ratings	
V_{CES}	$T_J = 25 \text{ C to } 150 \text{ C}$	600	V
V_{CGR}	$T_J = 25 \text{ C to } 150 \text{ C}; R_{GE} = 1 \text{ M}\Omega$	600	V
V_{GES}	Continuous	± 20	V
V_{GEM}	Transient	± 30	V
I_{C25}	$T_C = 25 \text{ C}$	20	A
I_{C110}	$T_C = 110 \text{ C}$	10	A
$I_{F(110)}$		11	A
I_{CM}	$T_C = 25 \text{ C}, 1 \text{ ms}$	30	A
SSOA (RBSOA)	$V_{GE} = 15 \text{ V}, T_J = 125 \text{ C}, R_G = 82\Omega$ Clamped inductive load, $V_{GE} = 20 \text{ V}$	$I_{CM} = 20$ @ $0.8 V_{CES}$	A
t_{SC} (SCSOA)	$V_{GE} = 15 \text{ V}, V_{CE} = 360 \text{ V}, T_J = 125 \text{ C}$ $R_G = 150 \Omega$, non repetitive	10	s
P_C	$T_C = 25 \text{ C}$	100	W
T_J		-55 ... +150	C
T_{JM}		150	C
T_{stg}		-55 ... +150	C
Maximum lead temperature for soldering 1.6 mm (0.062 in.) from case for 10 s		300	C
Plastic Body $t = 10\text{s}$		250	C
M_d	Mounting torque	(TO-220) 1.3/10	Nm/lb. in
Weight		2	g

TO-263 (IXSA)

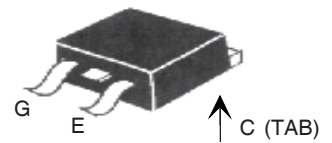

TO-220AB (IXSP)

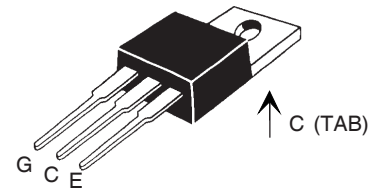

G = Gate C = Collector
E = Emitter TAB = Collector

Features

- International standard packages
- Guaranteed Short Circuit SOA capability
- Low $V_{CE(sat)}$
 - for low on-state conduction losses
- High current handling capability
- MOS Gate turn-on
 - drive simplicity
- Fast fall time for switching speeds up to 20 kHz

Applications

- AC motor speed control
- Uninterruptible power supplies (UPS)
- Welding

Advantages

- High power density

Symbol	Test Conditions	Characteristic Values			
		$(T_J = 25 \text{ C}, \text{ unless otherwise specified})$			
		min.	typ.	max.	
$V_{GE(th)}$	$I_C = 750 \text{ A}, V_{CE} = V_{GE}$	4.0		7.0	V
I_{CES}	$V_{CE} = V_{CES}$ $V_{GE} = 0 \text{ V}$			75	A
I_{GES}	$V_{CE} = 0 \text{ V}, V_{GE} = \pm 20 \text{ V}$			± 100	nA
$V_{CE(sat)}$	$I_C = 10\text{A}, V_{GE} = 15 \text{ V}$			2.5	V

Symbol	Test Conditions	Characteristic Values ($T_J = 25\text{ C}$, unless otherwise specified)		
		min.	typ.	max.
g_{fs}	$I_C = 10\text{ A}$; $V_{CE} = 10\text{ V}$, Note 1	2.0	3.6	S
C_{ies}			400	pF
C_{oes}	$V_{CE} = 25\text{ V}$, $V_{GE} = 0\text{ V}$		50	pF
C_{res}	$f = 1\text{ MHz}$		11	pF
Q_g			17	nC
Q_{ge}	$I_C = 10\text{ A}$, $V_{GE} = 15\text{ V}$, $V_{CE} = 0.5 V_{CES}$		6	nC
Q_{gc}			7.5	nC
$t_{d(on)}$	Inductive load, $T_J = 25\text{ C}$		30	ns
t_{ri}	$I_C = 10\text{ A}$, $V_{GE} = 15\text{ V}$		30	ns
$t_{d(off)}$	$V_{CE} = 0.8 V_{CES}$, $R_G = 30\ \Omega$		180	ns
t_{fi}	Switching times may increase for V_{CE} (Clamp) $> 0.8 \cdot V_{CES}$, higher T_J or increased R_G		165	ns
E_{off}			430	750 J
$t_{d(on)}$			30	ns
t_{ri}			30	ns
E_{on}	Inductive load, $T_J = 125\text{ C}$		0.32	mJ
$t_{d(off)}$	$I_C = 10\text{ A}$, $V_{GE} = 15\text{ V}$		260	ns
t_{fi}	$V_{CE} = 0.8 V_{CES}$, $R_G = 30\ \Omega$		270	ns
E_{off}	Switching times may increase for V_{CE} (Clamp) $> 0.8 \cdot V_{CES}$, higher T_J or increased R_G		790	J
R_{thJC}				1.25 K/W
R_{thCS}	TO-220		0.25	K/W

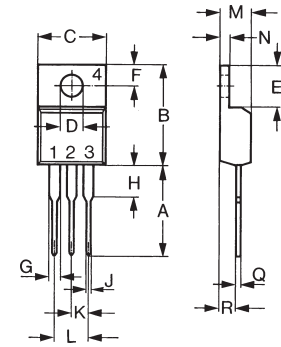
TO-220 AB (IXSP) Outline

Dim.	Millimeter		Inches	
	Min.	Max.	Min.	Max.
A	12.70	13.97	0.500	0.550
B	14.73	16.00	0.580	0.630
C	9.91	10.66	0.390	0.420
D	3.54	4.08	0.139	0.161
E	5.85	6.85	0.230	0.270
F	2.54	3.18	0.100	0.125
G	1.15	1.65	0.045	0.065
H	2.79	5.84	0.110	0.230
J	0.64	1.01	0.025	0.040
K	2.54	BSC	0.100	BSC
M	4.32	4.82	0.170	0.190
N	1.14	1.39	0.045	0.055
Q	0.35	0.56	0.014	0.022
R	2.29	2.79	0.090	0.110

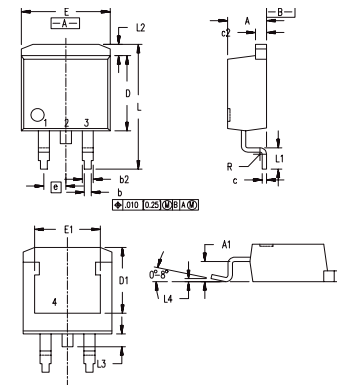
TO-263 (IXSA) Outline

Dim.	Millimeter		Inches	
	Min.	Max.	Min.	Max.
A	4.06	4.83	.160	.190
A1	2.03	2.79	.080	.110
b	0.51	0.99	.020	.039
b2	1.14	1.40	.045	.055
c	0.46	0.74	.018	.029
c2	1.14	1.40	.045	.055
D	8.64	9.65	.340	.380
D1	7.11	8.13	.280	.320
E	9.65	10.29	.380	.405
E1	6.86	8.13	.270	.320
e	2.54	BSC	.100	BSC
L	14.61	15.88	.575	.625
L1	2.29	2.79	.090	.110
L2	1.02	1.40	.040	.055
L3	1.27	1.78	.050	.070
L4	0	0.38	0	.015
R	0.46	0.74	.018	.029

Symbol	Test Conditions	Characteristic Values ($T_J = 25\text{ C}$, unless otherwise specified)		
		min.	typ.	max.
V_F	$I_F = 10\text{ A}$, $V_{GE} = 0\text{ V}$	$T_J = 150\text{ C}$		1.66 V 2.66 V
I_{RM}	$I_F = 12\text{ A}$, $V_{GE} = 0\text{ V}$, $-di_F/dt = 100\text{ A/s}$	$T_J = 100\text{ C}$	1.5	A
t_{rr}	$V_R = 100\text{ V}$	$T_J = 100\text{ C}$	90	ns
t_{rr}	$I_F = 1\text{ A}$; $-di/dt = 100\text{ A/s}$; $V_R = 30\text{ V}$		25	ns
R_{thJC}				2.5 K/W

Note 1: Pulse test, $t \leq 300\ \mu\text{s}$, duty cycle $d \leq 2\%$

IXYS reserves the right to change limits, test conditions, and dimensions.

IXYS MOSFETs and IGBTs are covered by one or more of the following U.S. patents:

4,835,592	4,931,844	5,049,961	5,237,481	6,162,665	6,404,065 B1	6,683,344	6,727,585
4,850,072	5,017,508	5,063,307	5,381,025	6,259,123 B1	6,534,343	6,710,405 B2	
4,881,106	5,034,796	5,187,117	5,486,715	6,306,728 B1	6,583,505	6,710,463	

Fig. 1. Output Characteristics @ 25 °C

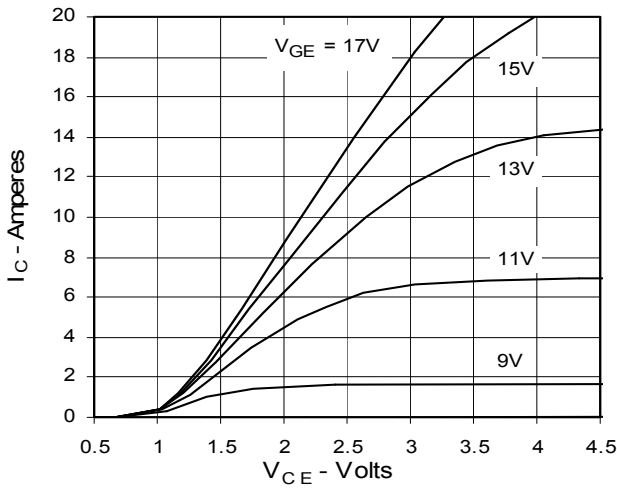

Fig. 2. Extended Output Characteristics @ 25 °C

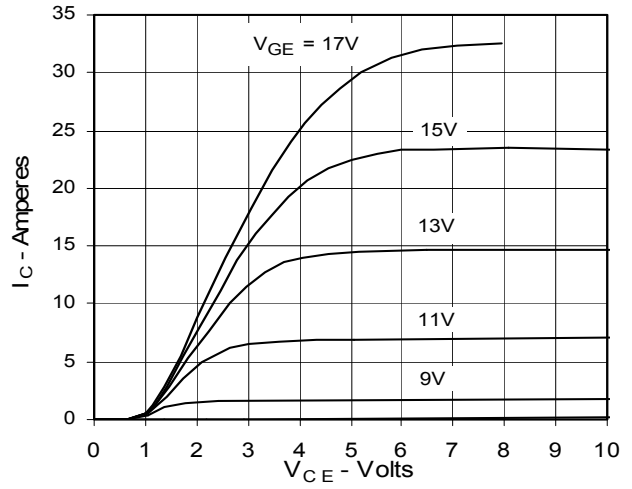

Fig. 3. Output Characteristics @ 125 °C

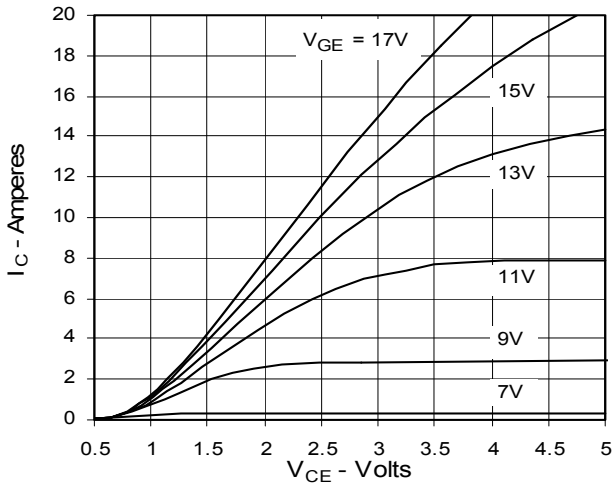

Fig. 4. Dependence of $V_{CE(sat)}$ on Temperature

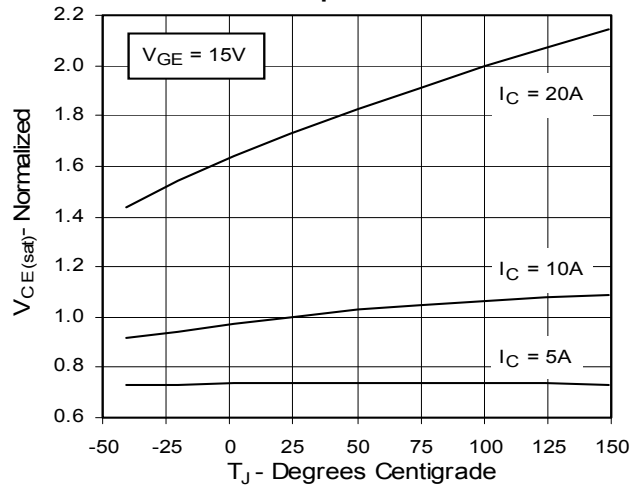

Fig. 5. Collector-to-Emitter Voltage vs. Gate-to-Emitter voltage

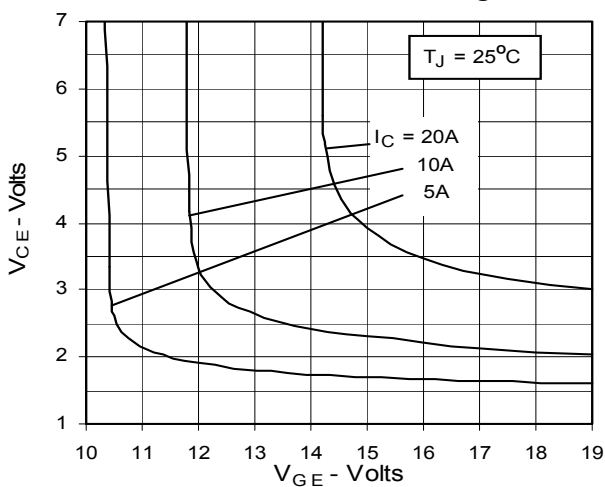

Fig. 6. Input Admittance

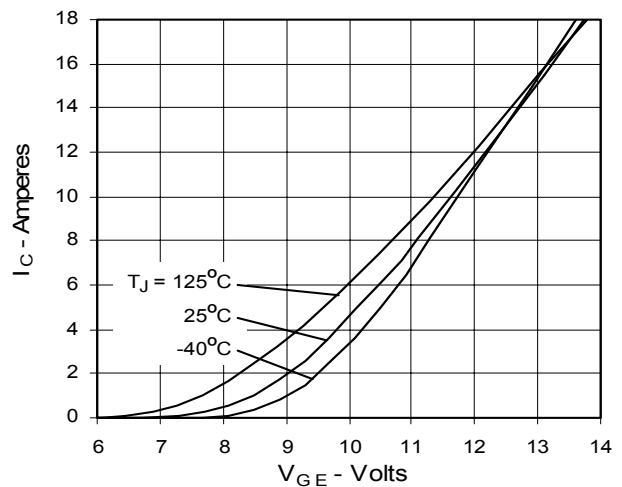

Fig. 7. Transconductance

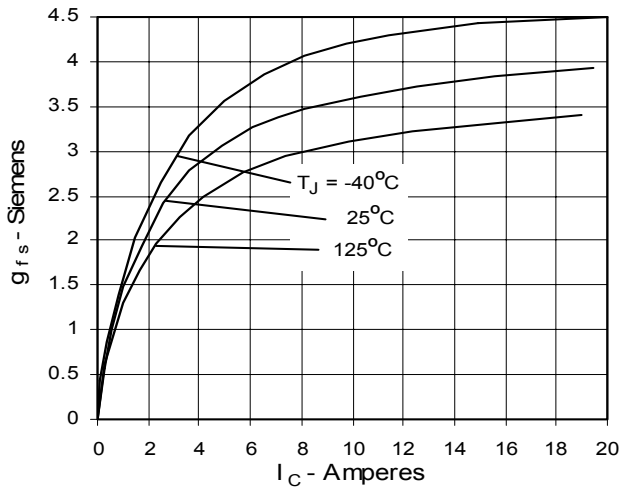

Fig. 8. Dependence of Turn-off Energy Loss on R_G

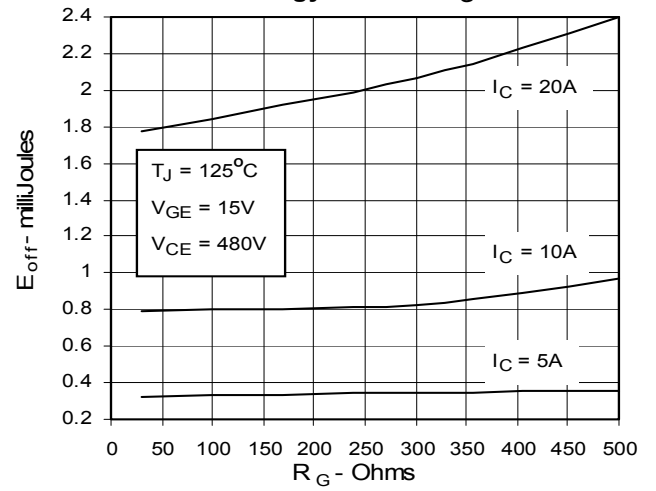

Fig. 9. Dependence of Turn-Off Energy Loss on I_C

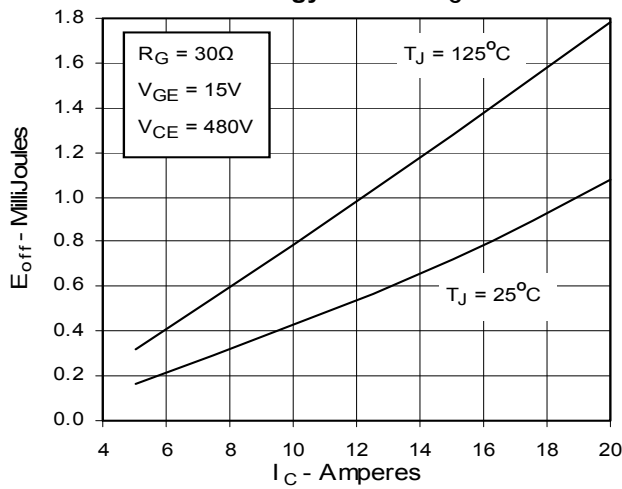

Fig. 10. Dependence of Turn-off Energy Loss on Temperature

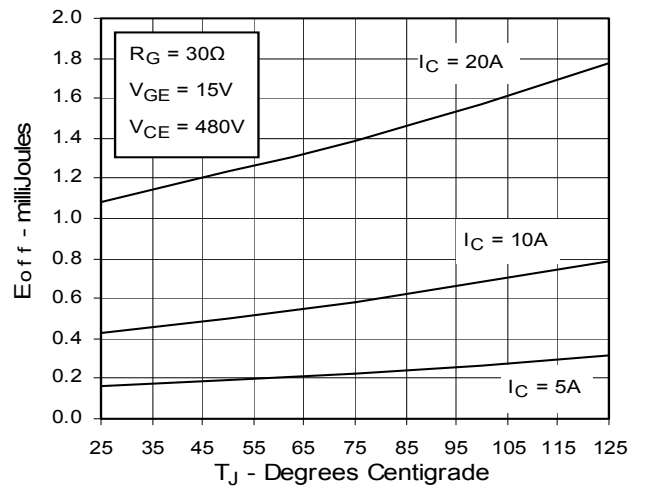

Fig. 11. Dependence of Turn-off Switching Time on R_G

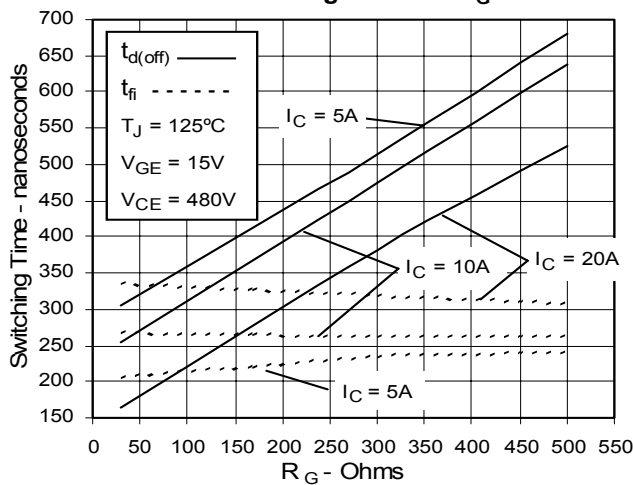

Fig. 12. Dependence of Turn-off Switching Time on I_C

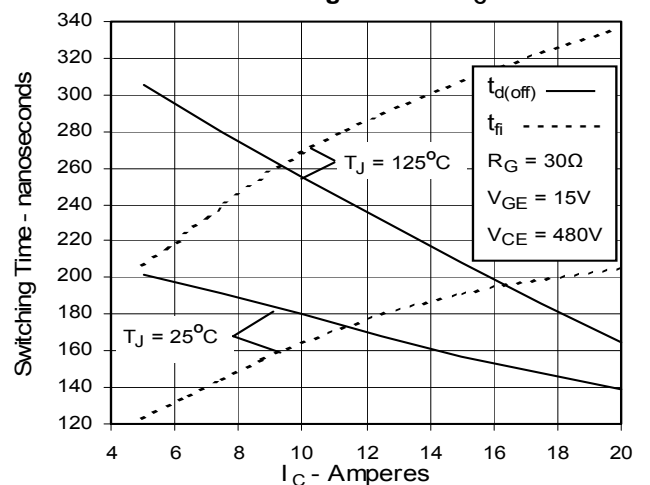

Fig. 13. Dependence of Turn-off Switching Time on Temperature

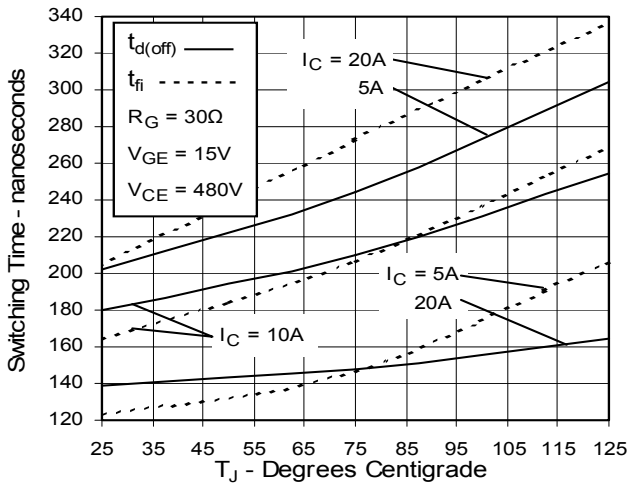

Fig. 14. Gate Charge

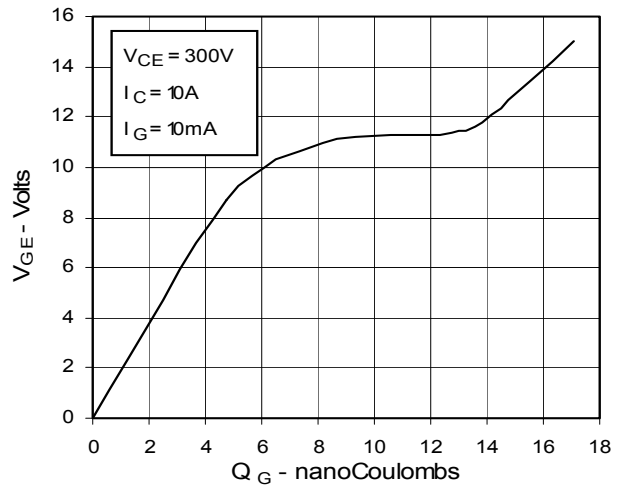

Fig. 15. Capacitance

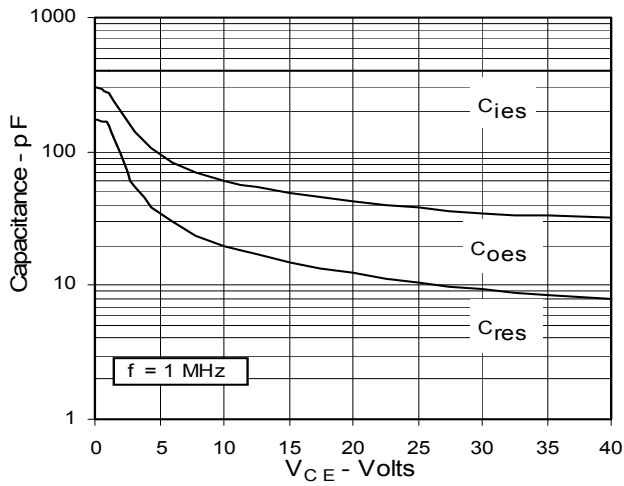

Fig. 16. Reverse-Bias Safe Operating Area

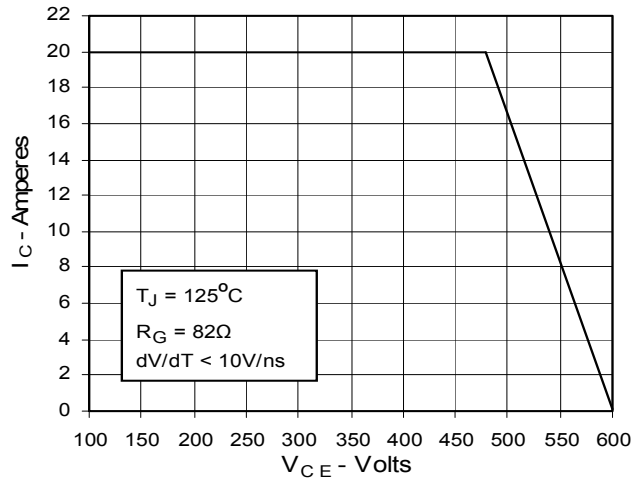
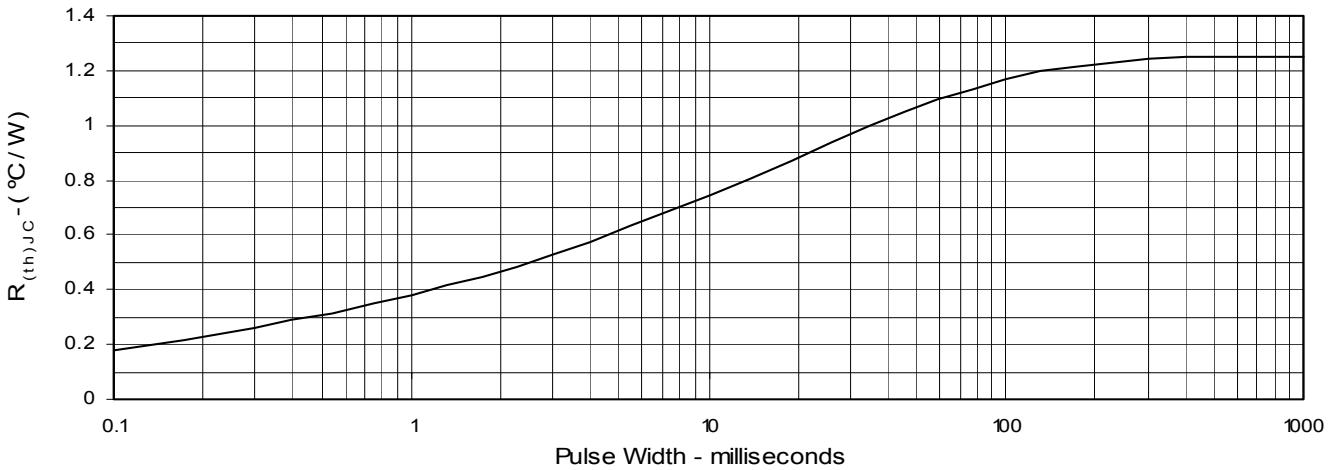

Fig. 17. Maximum Transient Thermal Resistance



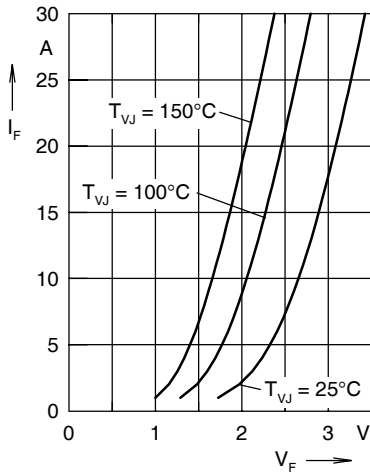

Fig. 18. Forward current I_F versus V_F

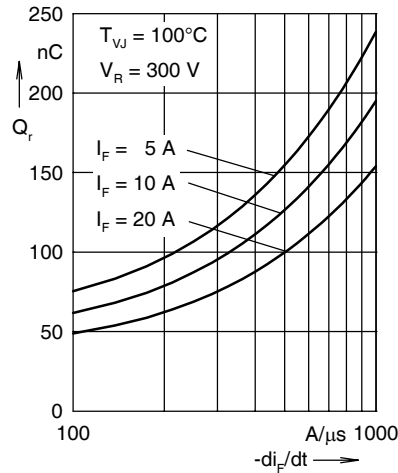

Fig. 19. Reverse recovery charge Q_r versus $-di_F/dt$

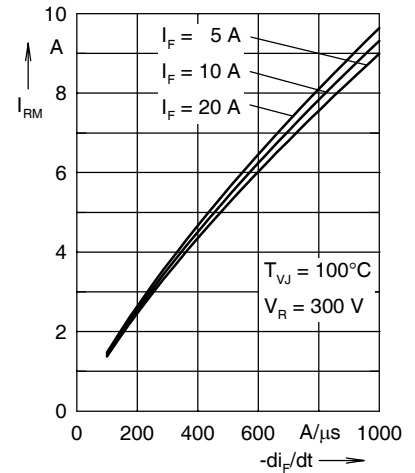

Fig. 20. Peak reverse current I_{RM} versus $-di_F/dt$

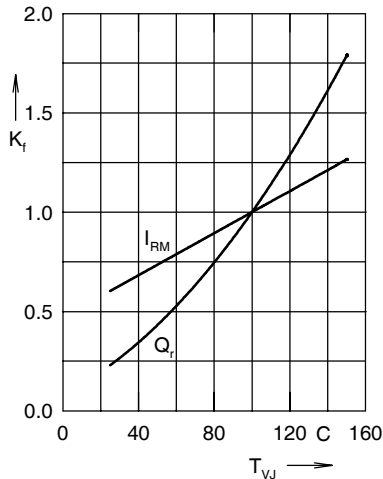

Fig. 21. Dynamic parameters Q_r , I_{RM} versus T_{VJ}

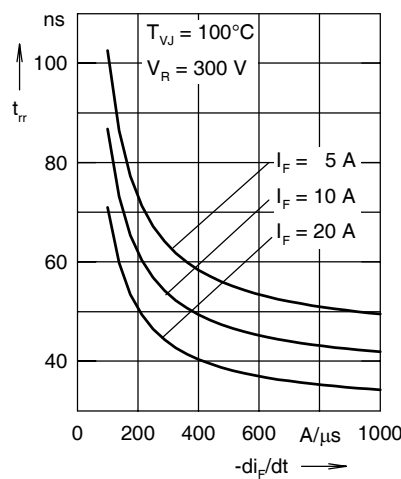

Fig. 22. Recovery time t_{rr} versus $-di_F/dt$

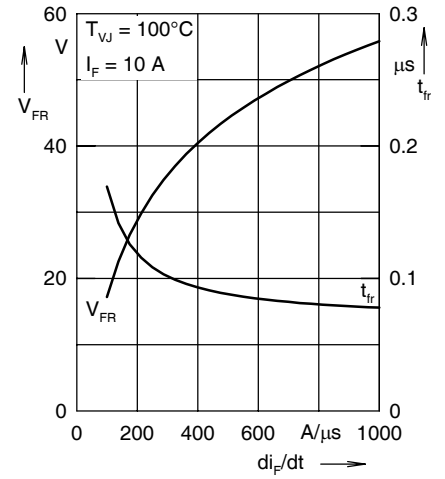

Fig. 23. Peak forward voltage V_{FR} and t_{fr} versus di_F/dt

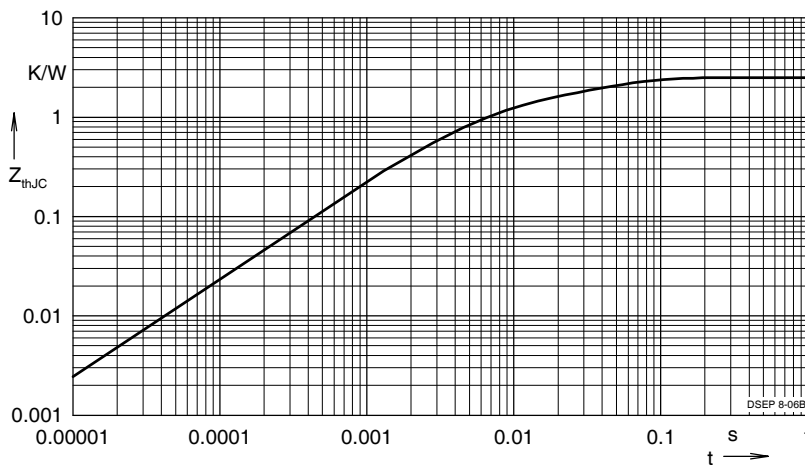

Fig. 24. Transient thermal resistance junction-to-case

NOTE: Fig. 19 to Fig. 23 shows typical values

Constants for Z_{thJC} calculation:

i	R_{thi} (K/W)	t_i (s)
1	1.449	0.0052
2	0.5578	0.0003
3	0.4931	0.0169

IXYS reserves the right to change limits, test conditions, and dimensions.

IXYS MOSFETs and IGBTs are covered by one or more of the following U.S. patents:

4,835,592	4,881,106	5,017,508	5,049,961	5,187,117	5,381,025	6,162,665	6,306,728 B1	6,534,343	6,683,344
4,850,072	4,931,844	5,034,796	5,063,307	5,237,481	5,486,715	6,259,123 B1	6,404,065 B1	6,583,505	6,710,405 B2