

LED SPACERS

Buy One or Buy Bulk & SAVE

SQLEDS Square LED Spacers

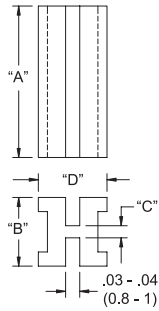
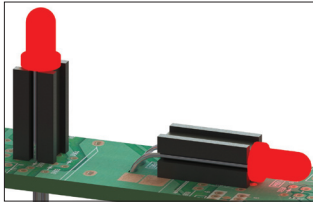

- Provides height control, lead wire retention and stability
- Square design is good for angled applications
- Material: UL94 V-0 PVC
- Color: Black

Item No.	LED Type	"A"	"B"	"C"	"D" Ref.	Bulk Pack Qty.
SQLEDS1-4-26	T-1 (3mm)	.250 (6.4)	.17 (4.3)	.03 (0.8)	.17 (4.3)	1,000
SQLEDS1-6-26	T-1 (3mm)	.375 (9.5)	.17 (4.3)	.03 (0.8)	.17 (4.3)	1,000
SQLEDS1-8-26	T-1 (3mm)	.500 (12.7)	.17 (4.3)	.03 (0.8)	.17 (4.3)	1,000
SQLEDS2-4-26	T-1-3/4 (5mm)	.250 (6.4)	.24 (6.1)	.07 (1.8)	.27 (6.9)	1,000
SQLEDS2-6-26	T-1-3/4 (5mm)	.375 (9.5)	.24 (6.1)	.07 (1.8)	.27 (6.9)	1,000
SQLEDS2-8-26	T-1-3/4 (5mm)	.500 (12.7)	.24 (6.1)	.07 (1.8)	.27 (6.9)	1,000
SQLEDS2-12-26	T-1-3/4 (5mm)	.750 (19.1)	.24 (6.1)	.07 (1.8)	.27 (6.9)	1,000

LEDH 90° LED Holder

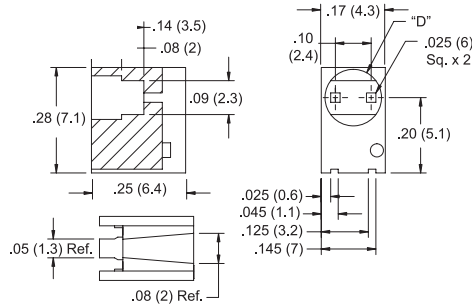
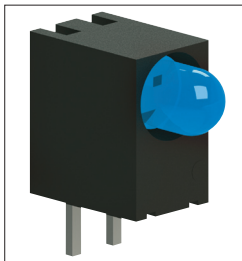

LEDH-101C

- Material: UL94 V-0 Nylon 6/6
- Color: Black

Item No.	Ø"D"	LED Type	Bulk Pack Qty.
LEDH-101C-34	.13 (3.4)	T-1 (3mm)	1,000
LEDH-101C-38	.15 (3.8)	T-1 (3mm)	1,000

- Allows LEDs to be mounted at a 90° angle
- Can be easily assembled by hand; no tools required

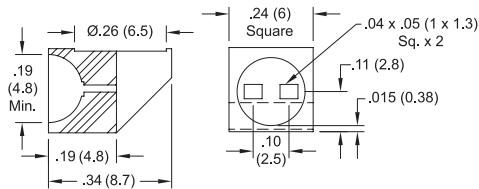

LEDH-909-235

- Material: UL94 V-2 Nylon 6/6
- Color: Black

Item No.	LED Type	Bulk Pack Qty.
LEDH-909-235	T-1 3/4 (5mm)	1,000

LEDHPM Panel Mount LED Holder

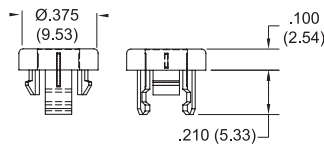
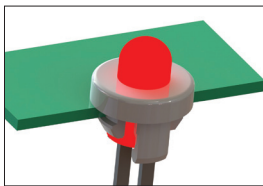

- Easily snapped into standard panel holes by hand
- Once the holder is snapped into the hole, the LED will lock into place when inserted from the rear of the panel
- Provides a secure, attractive display
- Fits standard T-1 3/4 LEDs
- Material: UL94 V-2 Nylon 6/6
- Color: Natural

Item No.	Mounting Hole Ø	Panel Thickness	LED Type	Bulk Pack Qty.
LEDHPM-1	.281-.287 (7.14-7.29)	.044-.048 (1.12-1.22)	T-1 3/4 (5mm)	1,000

LEDRC LED Clips & Rings

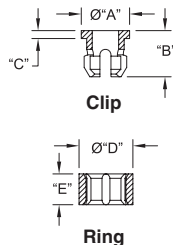
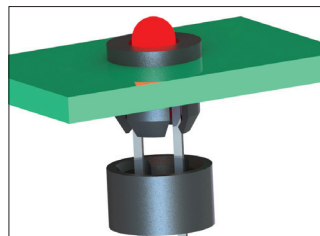
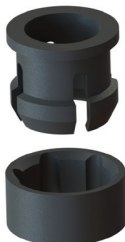

- The devices go together by simply inserting the "clip" to the front of the panel, then assembling the LED into the "clip" from the rear of the panel. The "ring" is pressed onto the rear of the "clip" for a firm retention
- Parts are sold in a set with both the clip and ring
- Securely and firmly mounts LEDs
- Material: Clip: UL94 V-0 Nylon 6/6, Ring: See Table
- Color: Black

Item No.	Ring Material	LED Type	Mounting Hole Ø	Panel Thickness	"A" Ø	"B"	"C"	"D" Ø	"E"	Bulk Pack Qty.
LEDRC-104	UL94 V-0 Nylon 6/6	T-1 (3mm)	.174-.180 (4.4-4.6)	.032-.125 (0.8-3.2)	.21 (5.3)	.21 (5.3)	.015 (0.38)	.24 (6.1)	.14 (3.6)	1,000
LEDRC-174	UL94 V-2 Nylon 6/6	T-1-3/4 (5mm)	.267-.273 (6.8-6.9)	.032-.125 (0.8-3.2)	.30 (7.6)	.26 (6.6)	.030 (0.76)	.35 (8.9)	.16 (4.1)	1,000