



LMC6001 Ultra, Ultra-Low Input Current Amplifier

1 Features

- (Maximum Limit, 25°C Unless Otherwise Noted)
- Input Current (100% Tested): 25 fA
- Input Current Over Temperature: 2 pA
- Low Power: 750 μ W
- Low V_{OS} : 350 μ V
- Low Noise: 22 nV/ $\sqrt{\text{Hz}}$ at 1 kHz Typical

2 Applications

- Electrometer Amplifiers
- Photodiode Preamplifiers
- Ion Detectors
- A.T.E. Leakage Testing

3 Description

Featuring 100% tested input currents of 25 fA maximum, low operating power, and ESD protection of 2000 V, the LMC6001 device achieves a new industry benchmark for low input current operational amplifiers. By tightly controlling the molding compound, Texas Instruments is able to offer this ultra-low input current in a lower cost molded package.

To avoid long turnon settling times common in other low input current op amps, the LMC6001A is tested three times in the first minute of operation. Even units that meet the 25-fA limit are rejected if they drift.

Because of the ultra-low input current noise of 0.13 fA/ $\sqrt{\text{Hz}}$, the LMC6001 can provide almost noiseless amplification of high resistance signal sources. Adding only 1 dB at 100 k Ω , 0.1 dB at 1 M Ω and 0.01 dB or less from 10 M Ω to 2,000 M Ω , the LMC6001 is an almost noiseless amplifier.

The LMC6001 is ideally suited for electrometer applications requiring ultra-low input leakage such as sensitive photodetection transimpedance amplifiers and sensor amplifiers. Because input referred noise is only 22 nV/ $\sqrt{\text{Hz}}$, the LMC6001 can achieve higher signal to noise ratio than JFET input type electrometer amplifiers. Other applications of the LMC6001 include long interval integrators, ultra-high input impedance instrumentation amplifiers, and sensitive electrical-field measurement circuits.

Device Information⁽¹⁾

PART NUMBER	PACKAGE	BODY SIZE (NOM)
LMC6001	PDIP (8)	9.81 mm x 6.35 mm
	TO-99 (8)	9.08 mm x 9.08 mm

(1) For all available packages, see the orderable addendum at the end of the data sheet.

Simplified Schematic

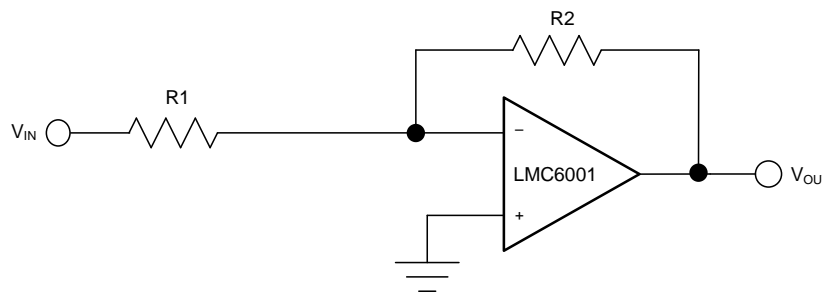

5 Pin Configuration and Functions

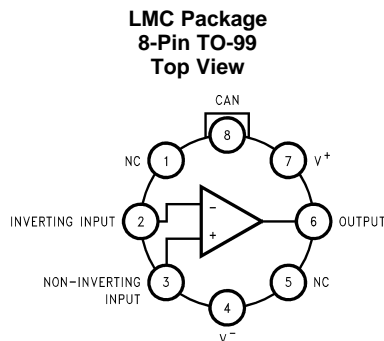
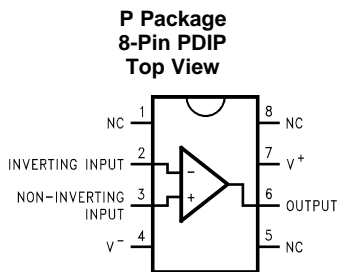

Pin Functions

PIN			I/O	DESCRIPTION
NAME	PDIP NO.	TO-99 NO.		
CAN	—	8	—	No internal connection; connected to the external casing.
+IN	3	3	I	Noninverting Input
-IN	2	2	I	Inverting Input
NC	1, 5, 8	1, 5	—	No connection
OUTPUT	6	6	O	Output
V+	7	7	—	Positive (higher) power supply
V-	4	4	—	Negative (lower) power supply

6 Specifications

6.1 Absolute Maximum Ratings

Over operating free-air temperature range (unless otherwise noted)⁽¹⁾⁽²⁾

	MIN	MAX	Unit
Differential Input Voltage	±Supply Voltage		
Voltage at Input/Output Pin	(V ⁺) + 0.3	(V ⁻) - 0.3	V
Supply Voltage (V ⁺ - V ⁻)	-0.3	+16	V
Output Short Circuit to V ⁺	See ⁽³⁾⁽⁴⁾		
Output Short Circuit to V ⁻	See ⁽³⁾		
Lead Temperature (Soldering, 10 Sec.)	260		°C
Junction Temperature	150		°C
Current at Input Pin	±10		mA
Current at Output Pin	±30		mA
Current at Power Supply Pin	40		mA
Storage Temperature, T _{stg}	-65	150	°C

- (1) Stresses beyond those listed under *Absolute Maximum Ratings* may cause permanent damage to the device. These are stress ratings only, which do not imply functional operation of the device at these or any other conditions beyond those indicated under *Recommended Operating Conditions*. Exposure to absolute-maximum-rated conditions for extended periods may affect device reliability.
- (2) If Military/Aerospace specified devices are required, please contact the Texas Instruments Sales Office/ Distributors for availability and specifications.
- (3) Applies to both single supply and split supply operation. Continuous short circuit operation at elevated ambient temperature can result in exceeding the maximum allowed junction temperature of 150°C. Output currents in excess of ±30 mA over long term may adversely affect reliability.
- (4) Do not connect the output to V⁺, when V⁺ is greater than 13 V or reliability will be adversely affected.

6.2 ESD Ratings

		VALUE	UNIT
$V_{(ESD)}$	Electrostatic discharge	Human body model (HBM), per ANSI/ESDA/JEDEC JS-001 ⁽¹⁾⁽²⁾	±2000 V

- (1) JEDEC document JEP155 states that 500-V HBM allows safe manufacturing with a standard ESD control process.
 (2) Human body model, 1.5 kΩ in series with 100 pF.

6.3 Recommended Operating Conditions

Over operating free-air temperature range (unless otherwise noted).

		MIN	MAX	UNIT
V_{SS}	Supply input voltage	4.5	15.5	V
T_J	Operating junction temperature	−40	85	°C

6.4 Thermal Information

THERMAL METRIC ⁽¹⁾	LMC6001		UNIT	
	P (PDIP)	LMC (TO-99)		
	8 PINS	8 PINS		
$R_{\theta JA}$	Junction-to-ambient thermal resistance	100	145	°C/W
$R_{\theta JC(top)}$	Junction-to-case (top) thermal resistance	—	45	°C/W

- (1) For more information about traditional and new thermal metrics, see the *Semiconductor and IC Package Thermal Metrics* application report, [SPRA953](#).

6.5 DC Electrical Characteristics for LMC6001AI

Limits are ensured for $T_J = 25^\circ\text{C}$ unless otherwise specified. Unless otherwise specified, $V^+ = 5\text{ V}$, $V^- = 0\text{ V}$, $V_{CM} = 1.5\text{ V}$, and $R_L > 1\text{ M}\Omega$.

PARAMETER	TEST CONDITIONS	LMC6001AI			UNIT	
		MIN ⁽¹⁾	TYP ⁽²⁾	MAX ⁽¹⁾		
I_B	Input Current Either Input, $V_{CM} = 0\text{ V}$, $V_S = \pm 5\text{ V}$ At the temperature extremes	10	25	2000	fA	
I_{OS}	Input Offset Current At the temperature extremes	5	1000	0.7	mV	
V_{OS}	Input Offset Voltage At the temperature extremes $V_S = \pm 5\text{ V}$, $V_{CM} = 0\text{ V}$ At the temperature extremes	1	10	1.35	μV/°C	
TCV_{OS}	Input Offset Voltage Drift	2.5			TΩ	
R_{IN}	Input Resistance	>1				
CMRR	Common Mode	$0\text{ V} \leq V_{CM} \leq 7.5\text{ V}$		75	83	dB
	Rejection Ratio	$V^+ = 10\text{ V}$	At the temperature extremes	72		
+PSRR	Positive Power Supply Rejection Ratio	$5\text{ V} \leq V^+ \leq 15\text{ V}$		73	83	
				70		
−PSRR	Negative Power Supply Rejection Ratio	$0\text{ V} \geq V^- \geq -10\text{ V}$		80	94	
				77		
A_V	Large Signal Voltage Gain	Sourcing, $R_L = 2\text{ k}\Omega$ ⁽³⁾		400	1400	V/mV
				300		
		Sinking, $R_L = 2\text{ k}\Omega$ ⁽³⁾		180	350	
			At the temperature extremes	100		

- (1) All limits are specified by testing or statistical analysis.
 (2) Typical values represent the most likely parametric norm.
 (3) $V^+ = 15\text{ V}$, $V_{CM} = 7.5\text{ V}$ and R_L connected to 7.5 V . For Sourcing tests, $7.5\text{ V} \leq V_O \leq 11.5\text{ V}$. For Sinking tests, $2.5\text{ V} \leq V_O \leq 7.5\text{ V}$.

DC Electrical Characteristics for LMC6001AI (continued)

Limits are ensured for $T_J = 25^\circ\text{C}$ unless otherwise specified. Unless otherwise specified, $V^+ = 5\text{ V}$, $V^- = 0\text{ V}$, $V_{\text{CM}} = 1.5\text{ V}$, and $R_L > 1\text{ M}$.

PARAMETER	TEST CONDITIONS		LMC6001AI			UNIT		
			MIN ⁽¹⁾	TYP ⁽²⁾	MAX ⁽¹⁾			
V_{CM}	Input Common-Mode Voltage	$V^+ = 5\text{ V}$ and 15 V For $\text{CMRR} \geq 60\text{ dB}$	V_{CM} Low		-0.4	-0.1	V	
				At the temperature extremes		0		
			V_{CM} High		$V^+ - 2.3$	$V^+ - 1.9$		
				At the temperature extremes	$V^+ - 2.5$			
V_{O}	Output Swing	$V^+ = 15\text{ V}$, $R_L = 2\text{ k}\Omega$ to 2.5 V	V_{O} Low		0.1	0.14	V	
				At the temperature extremes		0.17		
			V_{O} High		4.8	4.87		
				At the temperature extremes	4.73			
		$V^+ = 15\text{ V}$, $R_L = 2\text{ k}\Omega$ to 7.5 V	V_{O} Low		0.26	0.35		
				At the temperature extremes		0.45		
			V_{O} High		14.5	14.63		
				At the temperature extremes	14.34			
I_{O}	Output Current	Sourcing, $V^+ = 5\text{ V}$, $V_{\text{O}} = 0\text{ V}$		16	22	mA		
			At the temperature extremes	10				
		Sinking, $V^+ = 5\text{ V}$, $V_{\text{O}} = 5\text{ V}$		16	21			
			At the temperature extremes	13				
		Sourcing, $V^+ = 15\text{ V}$, $V_{\text{O}} = 0\text{ V}$		28	30			
			At the temperature extremes	22				
		Sinking, $V^+ = 15\text{ V}$, $V_{\text{O}} = 13\text{ V}^{(4)}$		28	34			
			At the temperature extremes	22				
I_{S}	Supply Current	$V^+ = 5\text{ V}$, $V_{\text{O}} = 1.5\text{ V}$		450	750	μA		
			At the temperature extremes		900			
		$V^+ = 15\text{ V}$, $V_{\text{O}} = 7.5\text{ V}$		550	850			
			At the temperature extremes		950			

(4) Do not connect the output to V^+ , when V^+ is greater than 13 V or reliability will be adversely affected.

6.6 DC Electrical Characteristics for LMC6001BI

Limits are ensured for $T_J = 25^\circ\text{C}$ unless otherwise specified. Unless otherwise specified, $V^+ = 5\text{ V}$, $V^- = 0\text{ V}$, $V_{CM} = 1.5\text{ V}$, and $R_L > 1\text{ M}$.

PARAMETER		TEST CONDITIONS		LMC6001BI			UNIT		
				MIN ⁽¹⁾	TYP ⁽²⁾	MAX ⁽¹⁾			
I_B	Input Current	Either Input, $V_{CM} = 0\text{ V}$, $V_S = \pm 5\text{ V}$				100	fA		
			At the temperature extremes					4000	
I_{OS}	Input Offset Current	At the temperature extremes				2000			
V_{OS}	Input Offset Voltage	$V_S = \pm 5\text{ V}$, $V_{CM} = 0\text{ V}$				1.35	mV		
			At the temperature extremes					1.7	
								10	
At the temperature extremes				2					
TCV_{OS}	Input Offset Voltage Drift						$\mu\text{V}/^\circ\text{C}$		
R_{IN}	Input Resistance						T Ω		
CMRR	Common Mode	$0\text{ V} \leq V_{CM} \leq 7.5\text{ V}$				72	dB		
	Rejection Ratio	$V^+ = 10\text{ V}$		At the temperature extremes		68			
+PSRR	Positive Power Supply Rejection Ratio	$5\text{ V} \leq V^+ \leq 15\text{ V}$				66		83	
				At the temperature extremes				63	
-PSRR	Negative Power Supply Rejection Ratio	$0\text{ V} \geq V^- \geq -10\text{ V}$				74		94	
				At the temperature extremes				71	
A_V	Large Signal Voltage Gain	Sourcing, $R_L = 2\text{ k}\Omega$ ⁽³⁾				300	1400	V/mV	
						200			
		Sinking, $R_L = 2\text{ k}\Omega$ ⁽³⁾		At the temperature extremes			90		350
							60		
V_{CM}	Input Common-Mode Voltage	$V^+ = 5\text{ V}$ and 15 V For CMRR $\geq 60\text{ dB}$	V_{CM} Low	At the temperature extremes		-0.4	-0.1	V	
							0		
			V_{CM} High	At the temperature extremes		$V^+ - 2.3$	$V^+ - 1.9$		
V_O	Output Swing	$V^+ = 15\text{ V}$, $R_L = 2\text{ k}\Omega$ to 2.5 V	V_O Low	At the temperature extremes		0.1	0.2	V	
							0.24		
			V_O High	At the temperature extremes		4.75	4.87		
					4.67				
		$V^+ = 15\text{ V}$, $R_L = 2\text{ k}\Omega$ to 7.5 V	V_O Low	At the temperature extremes			0.26		0.44
									0.56
V_O High	At the temperature extremes			14.37	14.63				
			14.25						

(1) All limits are specified by testing or statistical analysis.

(2) Typical values represent the most likely parametric norm.

(3) $V^+ = 15\text{ V}$, $V_{CM} = 7.5\text{ V}$ and R_L connected to 7.5 V . For Sourcing tests, $7.5\text{ V} \leq V_O \leq 11.5\text{ V}$. For Sinking tests, $2.5\text{ V} \leq V_O \leq 7.5\text{ V}$.

DC Electrical Characteristics for LMC6001BI (continued)

Limits are ensured for $T_J = 25^\circ\text{C}$ unless otherwise specified. Unless otherwise specified, $V^+ = 5\text{ V}$, $V^- = 0\text{ V}$, $V_{CM} = 1.5\text{ V}$, and $R_L > 1\text{ M}$.

PARAMETER	TEST CONDITIONS		LMC6001BI			UNIT
			MIN ⁽¹⁾	TYP ⁽²⁾	MAX ⁽¹⁾	
I_O Output Current	Sourcing, $V^+ = 5\text{ V}$, $V_O = 0\text{ V}$		13	22		mA
		At the temperature extremes	8			
	Sinking, $V^+ = 5\text{ V}$, $V_O = 5\text{ V}$		13	21		
		At the temperature extremes	10			
	Sourcing, $V^+ = 15\text{ V}$, $V_O = 0\text{ V}$		23	30		
		At the temperature extremes	18			
Sinking, $V^+ = 15\text{ V}$, $V_O = 13\text{ V}^{(4)}$		23	34			
	At the temperature extremes	18				
I_S Supply Current	$V^+ = 5\text{ V}$, $V_O = 1.5\text{ V}$			450	750	μA
		At the temperature extremes			900	
	$V^+ = 15\text{ V}$, $V_O = 7.5\text{ V}$			550	850	
		At the temperature extremes			950	

(4) Do not connect the output to V^+ , when V^+ is greater than 13 V or reliability will be adversely affected.

6.7 DC Electrical Characteristics for LMC6001CI

Limits are ensured for $T_J = 25^\circ\text{C}$ unless otherwise specified. Unless otherwise specified, $V^+ = 5\text{ V}$, $V^- = 0\text{ V}$, $V_{CM} = 1.5\text{ V}$, and $R_L > 1\text{ M}$.

PARAMETER	TEST CONDITIONS		LMC6001CI			UNIT
			MIN ⁽¹⁾	TYP ⁽²⁾	MAX ⁽¹⁾	
I_B Input Current	Either Input, $V_{CM} = 0\text{ V}$, $V_S = \pm 5\text{ V}$				1000	fA
		At the temperature extremes			4000	
I_{OS} Input Offset Current	At the temperature extremes				2000	
V_{OS} Input Offset Voltage	$V_S = \pm 5\text{ V}$, $V_{CM} = 0\text{ V}$				1	mV
					1.35	
TCV_{OS} Input Offset Voltage Drift						$\mu\text{V}/^\circ\text{C}$
R_{IN} Input Resistance						$\text{T}\Omega$
CMRR	Common Mode	$0\text{ V} \leq V_{CM} \leq 7.5\text{ V}$		66		dB
	Rejection Ratio	$V^+ = 10\text{ V}$	At the temperature extremes	63		
+PSRR Positive Power Supply Rejection Ratio	$5\text{ V} \leq V^+ \leq 15\text{ V}$			66	83	
		At the temperature extremes		63		
-PSRR Negative Power Supply Rejection Ratio	$0\text{ V} \geq V^- \geq -10\text{ V}$			74	94	
		At the temperature extremes		71		

(1) All limits are specified by testing or statistical analysis.

(2) Typical values represent the most likely parametric norm.

DC Electrical Characteristics for LMC6001CI (continued)

Limits are ensured for $T_J = 25^\circ\text{C}$ unless otherwise specified. Unless otherwise specified, $V^+ = 5\text{ V}$, $V^- = 0\text{ V}$, $V_{\text{CM}} = 1.5\text{ V}$, and $R_L > 1\text{ M}$.

PARAMETER	TEST CONDITIONS		LMC6001CI			UNIT
			MIN ⁽¹⁾	TYP ⁽²⁾	MAX ⁽¹⁾	
A_V Large Signal Voltage Gain	Sourcing, $R_L = 2\text{ k}\Omega$ ⁽³⁾		300	1400		V/mV
			200			
	Sinking, $R_L = 2\text{ k}\Omega$ ⁽³⁾	At the temperature extremes	90	350		
			60			
V_{CM} Input Common-Mode Voltage	$V^+ = 5\text{ V}$ and 15 V For $\text{CMRR} \geq 60\text{ dB}$	V_{CM} Low		-0.4	-0.1	V
			At the temperature extremes		0	
		V_{CM} High		$V^+ - 2.3$	$V^+ - 1.9$	
			At the temperature extremes	$V^+ - 2.5$		
V_O Output Swing	$V^+ = 15\text{ V}$, $R_L = 2\text{ k}\Omega$ to 2.5 V	V_O Low		0.1	0.2	V
			At the temperature extremes		0.24	
		V_O High		4.75	4.87	
			At the temperature extremes	4.67		
	$V^+ = 15\text{ V}$, $R_L = 2\text{ k}\Omega$ to 7.5 V	V_O Low		0.26	0.44	
			At the temperature extremes		0.56	
		V_O High		14.37	14.63	
			At the temperature extremes	14.25		
I_O Output Current	Sourcing, $V^+ = 5\text{ V}$, $V_O = 0\text{ V}$		13	22	mA	
			At the temperature extremes	8		
	Sinking, $V^+ = 5\text{ V}$, $V_O = 5\text{ V}$		13	21		
			At the temperature extremes	10		
	Sourcing, $V^+ = 15\text{ V}$, $V_O = 0\text{ V}$		23	30		
			At the temperature extremes	18		
	Sinking, $V^+ = 15\text{ V}$, $V_O = 13\text{ V}$ ⁽⁴⁾		23	34		
			At the temperature extremes	18		
I_S Supply Current	$V^+ = 5\text{ V}$, $V_O = 1.5\text{ V}$		450	750	μA	
			At the temperature extremes			900
	$V^+ = 15\text{ V}$, $V_O = 7.5\text{ V}$		550	850		
			At the temperature extremes			950

(3) $V^+ = 15\text{ V}$, $V_{\text{CM}} = 7.5\text{ V}$ and R_L connected to 7.5 V . For Sourcing tests, $7.5\text{ V} \leq V_O \leq 11.5\text{ V}$. For Sinking tests, $2.5\text{ V} \leq V_O \leq 7.5\text{ V}$.

(4) Do not connect the output to V^+ , when V^+ is greater than 13 V or reliability will be adversely affected.

6.8 AC Electrical Characteristics for LMC6001AIC

Limits in standard typeface ensured for $T_J = 25^\circ\text{C}$ unless otherwise specified. Unless otherwise specified, $V^+ = 5\text{ V}$, $V^- = 0\text{ V}$, $V_{\text{CM}} = 1.5\text{ V}$ and $R_L > 1\text{ M}$.

PARAMETER		TEST CONDITIONS		LMC6001AIC			UNIT
				MIN ⁽¹⁾	TYP ⁽²⁾	MAX ⁽¹⁾	
SR	Slew Rate	See ⁽³⁾		0.8	1.5	V/ μs	
			At the temperature extremes	0.6			
GBW	Gain-Bandwidth Product			1.3		MHz	
ϕ_{m}	Phase Margin			50		Deg	
G_M	Gain Margin			17		dB	
e_n	Input-Referred Voltage Noise	F = 1 kHz		22		nV/ $\sqrt{\text{Hz}}$	
i_n	Input-Referred Current Noise	F = 1 kHz		0.13		fA/ $\sqrt{\text{Hz}}$	
THD	Total Harmonic Distortion	F = 10 kHz, $A_V = -10$, $R_L = 100\text{ k}\Omega$, $V_O = 8\text{ V}_{\text{PP}}$		0.01%			

(1) All limits are specified by testing or statistical analysis.

(2) Typical values represent the most likely parametric norm.

(3) $V^+ = 15\text{ V}$. Connected as Voltage Follower with 10-V step input. Limit specified is the lower of the positive and negative slew rates.

6.9 AC Electrical Characteristics for LM6001BI

Limits in standard typeface ensured for $T_J = 25^\circ\text{C}$ unless otherwise specified. Unless otherwise specified, $V^+ = 5\text{ V}$, $V^- = 0\text{ V}$, $V_{\text{CM}} = 1.5\text{ V}$ and $R_L > 1\text{ M}$.

PARAMETER		TEST CONDITIONS		LM6001BI			UNIT
				MIN ⁽¹⁾	TYP ⁽²⁾	MAX ⁽¹⁾	
SR	Slew Rate	See ⁽³⁾		0.8	1.5	V/ μs	
			At the temperature extremes	0.6			
GBW	Gain-Bandwidth Product			1.3		MHz	
ϕ_{m}	Phase Margin			50		Deg	
G_M	Gain Margin			17		dB	
e_n	Input-Referred Voltage Noise	F = 1 kHz		22		nV/ $\sqrt{\text{Hz}}$	
i_n	Input-Referred Current Noise	F = 1 kHz		0.13		fA/ $\sqrt{\text{Hz}}$	
THD	Total Harmonic Distortion	F = 10 kHz, $A_V = -10$, $R_L = 100\text{ k}\Omega$, $V_O = 8\text{ V}_{\text{PP}}$		0.01%			

(1) All limits are specified by testing or statistical analysis.

(2) Typical values represent the most likely parametric norm.

(3) $V^+ = 15\text{ V}$. Connected as Voltage Follower with 10-V step input. Limit specified is the lower of the positive and negative slew rates.

6.10 AC Electrical Characteristics for LMC6001CI

Limits in standard typeface ensured for $T_J = 25^\circ\text{C}$ unless otherwise specified. Unless otherwise specified, $V^+ = 5\text{ V}$, $V^- = 0\text{ V}$, $V_{CM} = 1.5\text{ V}$ and $R_L > 1\text{ M}$.

PARAMETER		TEST CONDITIONS	LMC6001CI			UNIT
			MIN ⁽¹⁾	TYP ⁽²⁾	MAX ⁽³⁾	
SR	Slew Rate	See ⁽⁴⁾ At the temperature extremes	0.8	1.5		V/ μ s
			0.6			
GBW	Gain-Bandwidth Product			1.3		MHz
ϕ_{f_m}	Phase Margin			50		Deg
G_M	Gain Margin			17		dB
e_n	Input-Referred Voltage Noise	F = 1 kHz		22		nV/ $\sqrt{\text{Hz}}$
i_n	Input-Referred Current Noise	F = 1 kHz		0.13		fA/ $\sqrt{\text{Hz}}$
THD	Total Harmonic Distortion	F = 10 kHz, $A_V = -10$, $R_L = 100\text{ k}\Omega$, $V_O = 8\text{ V}_{PP}$		0.01%		

(1) All limits are specified by testing or statistical analysis.

(2) Typical values represent the most likely parametric norm.

(3) All limits are specified by testing or statistical analysis.

(4) $V^+ = 15\text{ V}$. Connected as Voltage Follower with 10-V step input. Limit specified is the lower of the positive and negative slew rates.

6.11 Dissipation Ratings

	MIN	MAX	UNIT
Power Dissipation	See ⁽¹⁾		

(1) For operating at elevated temperatures the device must be derated based on the thermal resistance θ_{JA} with $P_D = (T_J - T_A)/\theta_{JA}$.

6.12 Typical Characteristics

$V_S = \pm 7.5\text{ V}$, $T_A = 25^\circ\text{C}$, unless otherwise specified

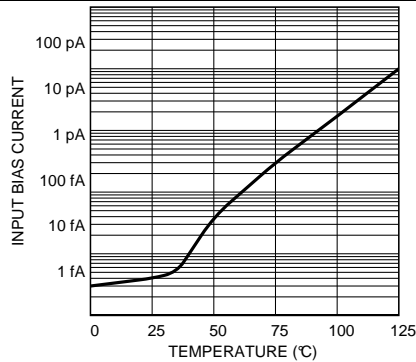
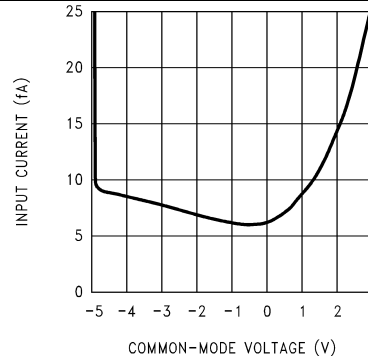

Figure 1. Input Current vs. Temperature



$V_S = \pm 5\text{ V}$

Figure 2. Input Current vs. V_{CM}

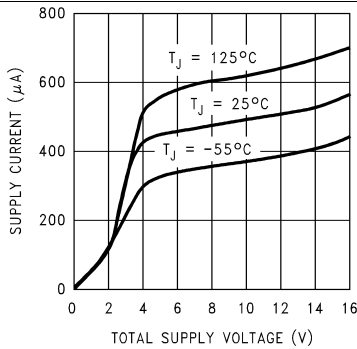

Figure 3. Supply Current vs. Supply Voltage

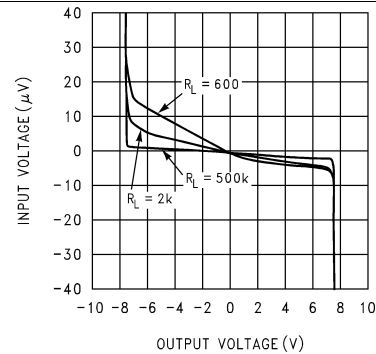

Figure 4. Input Voltage vs. Output Voltage

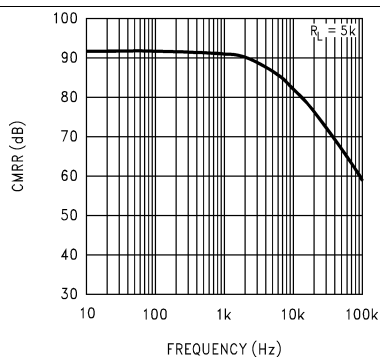

Figure 5. Common-Mode Rejection Ratio vs. Frequency

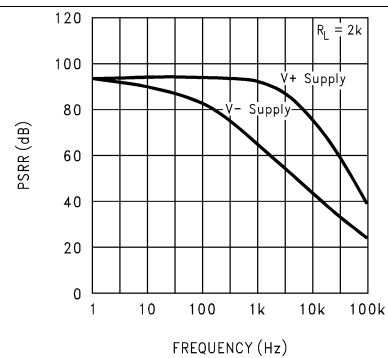

Figure 6. Power Supply Rejection Ratio vs. Frequency

Typical Characteristics (continued)

$V_S = \pm 7.5\text{ V}$, $T_A = 25^\circ\text{C}$, unless otherwise specified

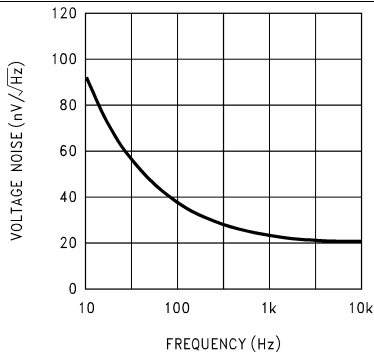

Figure 7. Input Voltage Noise vs. Frequency

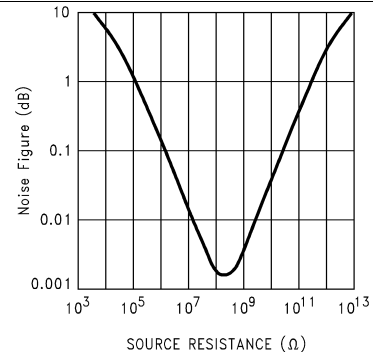

Figure 8. Noise Figure vs. Source Resistance

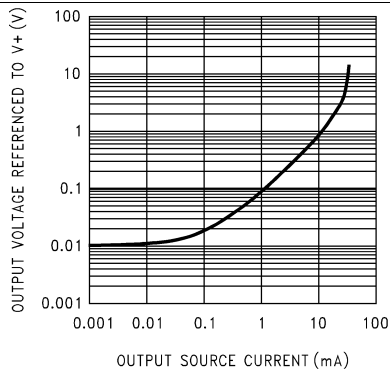

Figure 9. Output Characteristics Sourcing Current

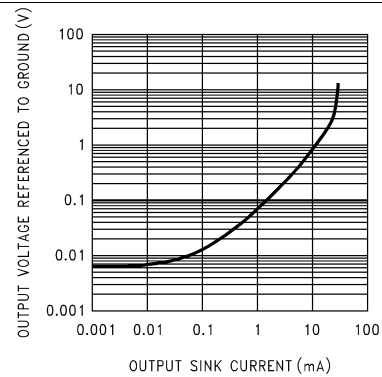

Figure 10. Output Characteristics Sinking Current

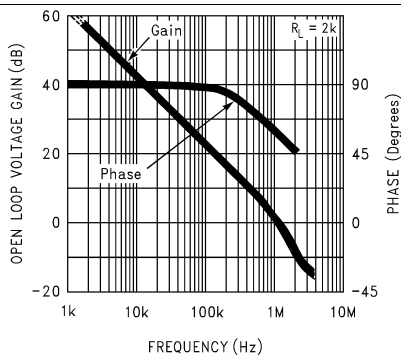
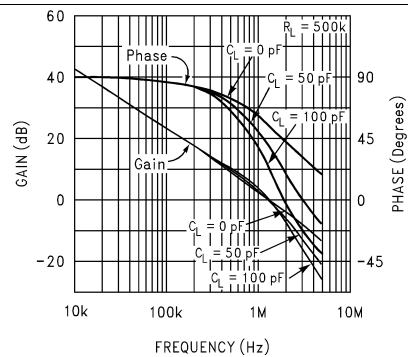

Figure 11. Gain and Phase Response vs. Temperature (-55°C to +125°C)



$R_L = 500\text{ k}\Omega$

Figure 12. Gain and Phase Response vs. Capacitive Load

Typical Characteristics (continued)

$V_S = \pm 7.5\text{ V}$, $T_A = 25^\circ\text{C}$, unless otherwise specified

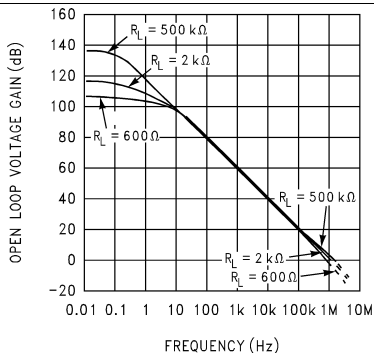

Figure 13. Open-Loop Frequency Response

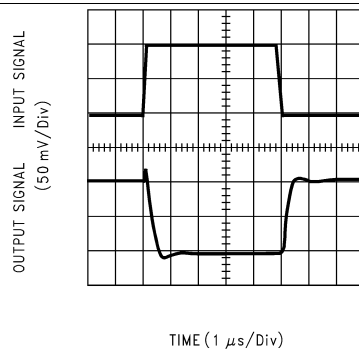

Figure 14. Inverting Small Signal Pulse Response

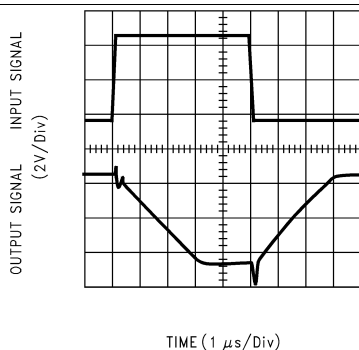

Figure 15. Inverting Large Signal Pulse Response

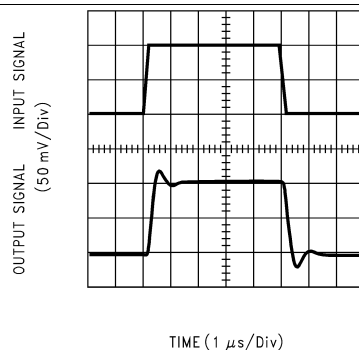

Figure 16. Noninverting Small Signal Pulse Response

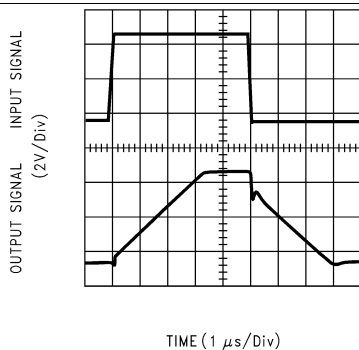

Figure 17. Noninverting Large Signal Pulse Response

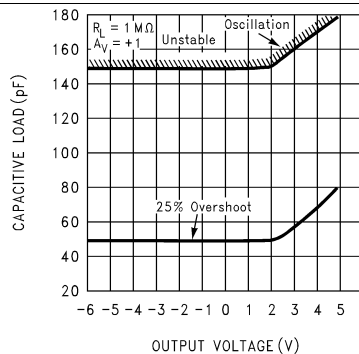

Figure 18. Stability vs. Capacitive Load

7 Detailed Description

7.1 Overview

LMC6001 has an extremely low input current of 25 fA. In addition, its ultra-low input current noise of $0.13 \text{ fA}/\sqrt{\text{Hz}}$ allows almost noiseless amplification of high-resistance signal sources. LMC6001 is ideally suited for electrometer applications requiring ultra-low input leakage current such as sensitive photodetection transimpedance amplifiers and sensor amplifiers.

7.2 Functional Block Diagram

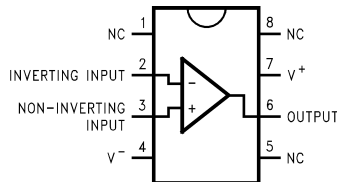

7.3 Feature Description

7.3.1 Amplifier Topology

The LMC6001 incorporates a novel op amp design topology that enables it to maintain rail-to-rail output swing even when driving a large load. Instead of relying on a push-pull unity gain output buffer stage, the output stage is taken directly from the internal integrator, which provides both low output impedance and large gain. Special feed-forward compensation design techniques are incorporated to maintain stability over a wider range of operating conditions than traditional op amps. These features make the LMC6001 both easier to design with, and provide higher speed than products typically found in this low-power class.

7.3.2 Latch-Up Prevention

CMOS devices tend to be susceptible to latch-up due to their internal parasitic SCR effects. The (I/O) input and output pins look similar to the gate of the SCR. There is a minimum current required to trigger the SCR gate lead. The LMC6001 is designed to withstand 100-mA surge current on the I/O pins. Some resistive method should be used to isolate any capacitance from supplying excess current to the I/O pins. In addition, like an SCR, there is a minimum holding current for any latch-up mode. Limiting current to the supply pins will also inhibit latch-up susceptibility.

7.4 Device Functional Modes

The LMC6001 has a single functional mode and operates according to the conditions listed in [Recommended Operating Conditions](#).

8 Applications and Implementation

NOTE

Information in the following applications sections is not part of the TI component specification, and TI does not warrant its accuracy or completeness. TI's customers are responsible for determining suitability of components for their purposes. Customers should validate and test their design implementation to confirm system functionality.

8.1 Application Information

8.1.1 Compensating For Input Capacitance

It is quite common to use large values of feedback resistance for amplifiers with ultra-low input current, like the LMC6001.

Although the LMC6001 is highly stable over a wide range of operating conditions, certain precautions must be met to achieve the desired pulse response when a large feedback resistor is used. Large feedback resistors with even small values of input capacitance, due to transducers, photodiodes, and printed-circuit-board parasitics, reduce phase margins.

When high input impedances are demanded, TI suggests guarding the LMC6001. Guarding input lines will not only reduce leakage, but lowers stray input capacitance as well. See [Printed-Circuit-Board Layout For High-Impedance Work](#).

The effect of input capacitance can be compensated for by adding a capacitor, C_f , around the feedback resistors (as in [Figure 19](#)) such that:

$$\frac{1}{2\pi R_1 C_{IN}} \geq \frac{1}{2\pi R_2 C_f} \quad (1)$$

or

$$R_1 C_{IN} \leq R_2 C_f \quad (2)$$

Because it is often difficult to know the exact value of C_{IN} , C_f can be experimentally adjusted so that the desired pulse response is achieved. Refer to the LMC660 ([SNOSBZ3](#)) and LMC662 ([SNOSC51](#)) for a more detailed discussion on compensating for input capacitance.

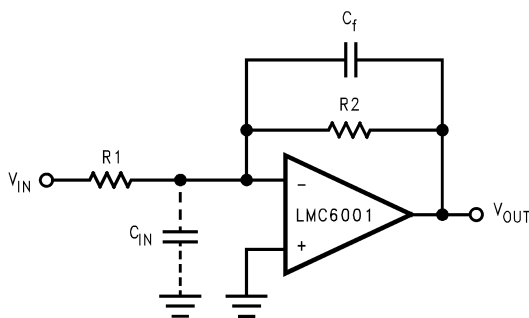

Figure 19. Cancelling the Effect of Input Capacitance

8.1.2 Capacitive Load Tolerance

All rail-to-rail output swing operational amplifiers have voltage gain in the output stage. A compensation capacitor is normally included in this integrator stage. The frequency location of the dominant pole is affected by the resistive load on the amplifier. Capacitive load driving capability can be optimized by using an appropriate resistive load in parallel with the capacitive load. See [Typical Characteristics](#).

Direct capacitive loading will reduce the phase margin of many op amps. A pole in the feedback loop is created by the combination of the output impedance of the op amp and the capacitive load. This pole induces phase lag at the unity-gain crossover frequency of the amplifier resulting in either an oscillatory or underdamped pulse response. With a few external components, op amps can easily indirectly drive capacitive loads, as shown in [Figure 20](#).

Application Information (continued)

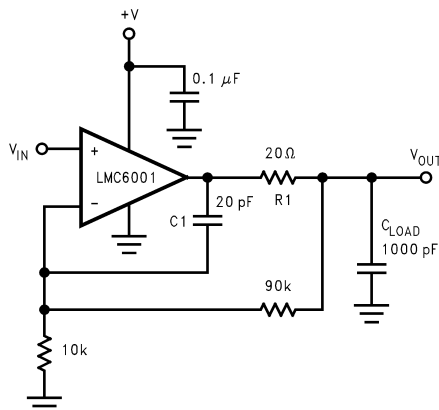

Figure 20. LMC6001 Noninverting Gain of 10 Amplifier, Compensated to Handle Capacitive Loads

In the circuit of Figure 20, R1 and C1 serve to counteract the loss of phase margin by feeding the high frequency component of the output signal back to the inverting input of the amplifier, thereby preserving phase margin in the overall feedback loop.

Capacitive load driving capability is enhanced by using a pullup resistor to V⁺ (Figure 21). Typically a pullup resistor conducting 500 μA or more will significantly improve capacitive load responses. The value of the pullup resistor must be determined based on the current sinking capability of the amplifier with respect to the desired output swing. Open-loop gain of the amplifier can also be affected by the pullup resistor. See DC Electrical Characteristics for LMC6001AI.

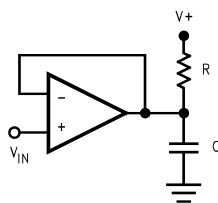

Figure 21. Compensating for Large Capacitive Loads With a Pullup Resistor

8.2 Typical Application

The extremely high input resistance, and low power consumption, of the LMC6001 make it ideal for applications that require battery-powered instrumentation amplifiers. Examples of these types of applications are hand-held pH probes, analytic medical instruments, electrostatic field detectors and gas chromatographs.

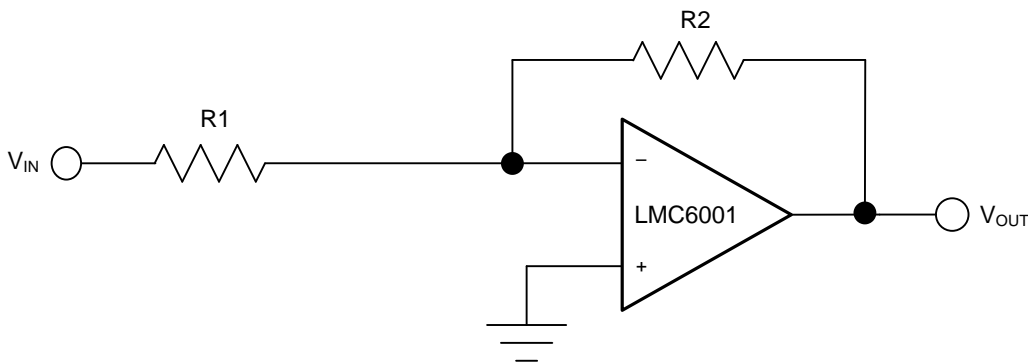

Figure 22. Typical Application Schematic, LMC6001

Typical Application (continued)

8.2.1 Two Op Amp, Temperature Compensated Ph Probe Amplifier

The signal from a pH probe has a typical resistance between 10 M Ω and 1000 M Ω . Because of this high value, it is very important that the amplifier input currents be as small as possible. The LMC6001 with less than 25-fA input current is an ideal choice for this application.

The LMC6001 amplifies the probe output providing a scaled voltage of ± 100 mV/pH from a pH of 7. The second op amp, a micropower LMC6041 provides phase inversion and offset so that the output is directly proportional to pH, over the full range of the probe. The pH reading can now be directly displayed on a low-cost, low-power digital panel meter. Total current consumption will be about 1 mA for the whole system.

The micropower dual-operational amplifier, LMC6042, would optimize power consumption but not offer these advantages:

1. The LMC6001A ensures a 25-fA limit on input current at 25°C.
2. The input ESD protection diodes in the LMC6042 are only rated at 500 V while the LMC6001 has much more robust protection that is rated at 2000 V.

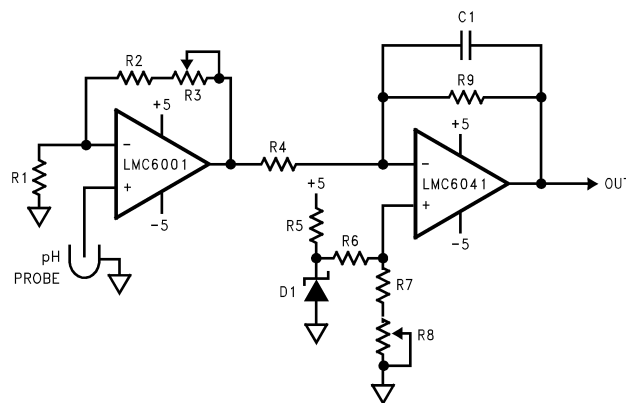

(1)

R1 100 k + 3500 ppm/°C

R2 68.1 k

R3, 8 5 k

R4, 9 100 k

R5 36.5 k

R6 619 k

R7 97.6 k

D1 LM4040D1Z-2.5

C1 2.2 μ F

(2) $\mu\Omega$ style 137 or similar

Figure 23. Ph Probe Amplifier

8.2.1.1 Design Requirements

The theoretical output of the standard Ag/AgCl pH probe is 59.16 mV/pH at 25°C with 0 V out at a pH of 7.00. This output is proportional to absolute temperature. To compensate for this, a temperature-compensating resistor, R1, is placed in the feedback loop. This cancels the temperature dependence of the probe. This resistor must be mounted where it will be at the same temperature as the liquid being measured.

8.2.1.2 Detailed Design Procedure

The set-up and calibration is simple with no interactions to cause problems.

Typical Application (continued)

1. Disconnect the pH probe and with R3 set to about mid-range and the noninverting input of the LMC6001 grounded, adjust R8 until the output is 700 mV.
2. Apply -414.1 mV to the noninverting input of the LMC6001. Adjust R3 for an output of 1400 mV. This completes the calibration. As real pH probes may not perform exactly to theory, minor gain and offset adjustments should be made by trimming while measuring a precision buffer solution.

8.2.1.3 Application Curve

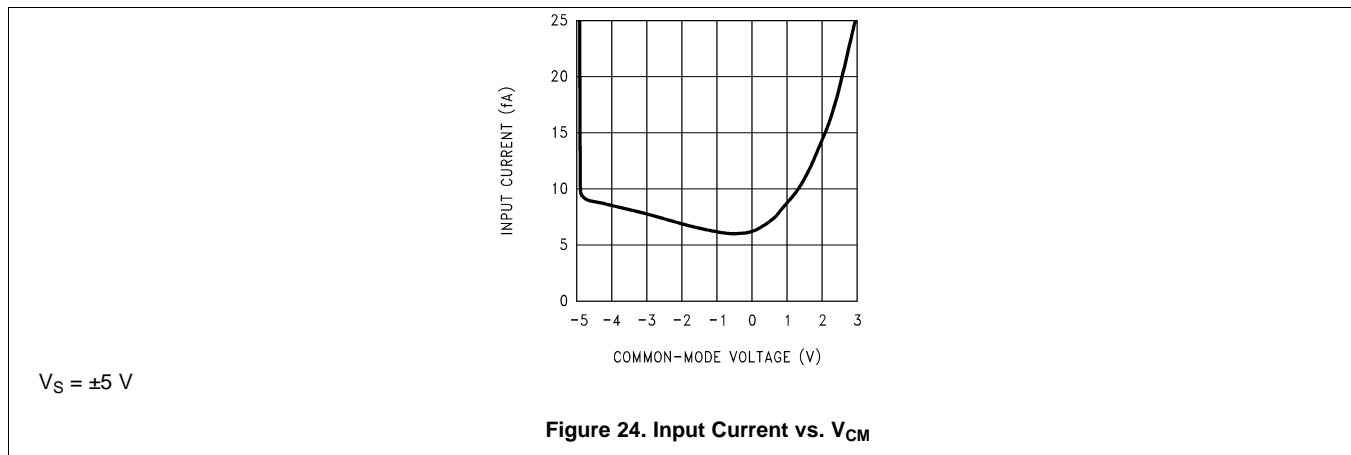

8.3 System Example

8.3.1 Ultra-Low Input Current Instrumentation Amplifier

Figure 25 shows an instrumentation amplifier that features high-differential and common-mode input resistance ($>10^{14}\Omega$), 0.01% gain accuracy at $A_V = 1000$, excellent CMRR with 1-M Ω imbalance in source resistance. Input current is less than 20 fA and offset drift is less than 2.5 $\mu\text{V}/^\circ\text{C}$. R_2 provides a simple means of adjusting gain over a wide range without degrading CMRR. R_7 is an initial trim used to maximize CMRR without using super precision matched resistors. For good CMRR over temperature, low-drift resistors should be used.

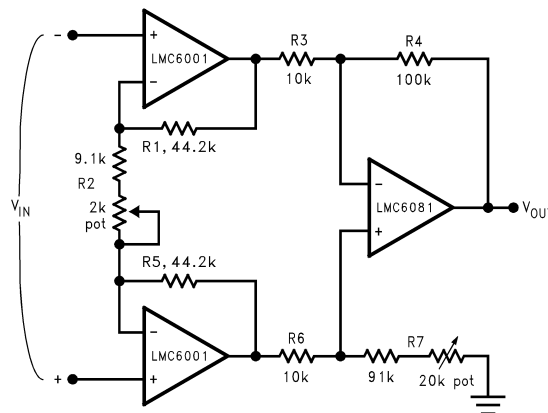

If $R_1 = R_5$, $R_3 = R_6$, and $R_4 = R_7$; then

$$\frac{V_{OUT}}{V_{IN}} = \frac{R_2 + 2R_1}{R_2} \times \frac{R_4}{R_3}$$

$\therefore A_V \approx 100$ for circuit shown ($R_2 = 9.85\text{k}$).

Figure 25. Instrumentation Amplifier

9 Power Supply Recommendations

See the [Recommended Operating Conditions](#) for the minimum and maximum values for the supply input voltage and operating junction temperature.

10 Layout

10.1 Layout Guidelines

10.1.1 Printed-Circuit-Board Layout For High-Impedance Work

It is generally recognized that any circuit which must operate with less than 1000 pA of leakage current requires special layout of the PCB. When one wishes to take advantage of the ultra-low bias current of the LMC6001, typically less than 10 fA, it is essential to have an excellent layout. Fortunately, the techniques of obtaining low leakages are quite simple. First, the user must not ignore the surface leakage of the PCB, even though it may sometimes appear acceptably low, because under conditions of high humidity or dust or contamination, the surface leakage will be appreciable.

To minimize the effect of any surface leakage, lay out a ring of foil completely surrounding the inputs of the LMC6001 and the terminals of capacitors, diodes, conductors, resistors, relay terminals, and so forth, connected to the inputs of the op amp, as in [Figure 30](#). To have a significant effect, guard rings must be placed on both the top and bottom of the PCB. This PC foil must then be connected to a voltage which is at the same voltage as the amplifier inputs, because no leakage current can flow between two points at the same potential. For example, a PCB trace-to-pad resistance of 10 TΩ, which is normally considered a very large resistance, could leak 5 pA if the trace were a 5-V bus adjacent to the pad of the input.

This would cause a 500 times degradation from the LMC6001's actual performance. If a guard ring is used and held within 1 mV of the inputs, then the same resistance of 10 TΩ will only cause 10 fA of leakage current. Even this small amount of leakage will degrade the extremely low input current performance of the LMC6001. See [Figure 28](#) for typical connections of guard rings for standard op amp configurations.

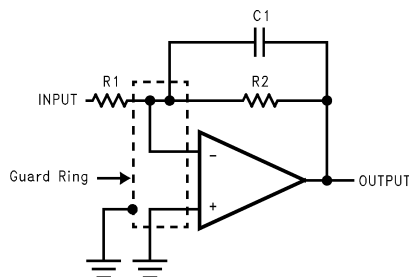

Figure 26. Inverting Amplifier

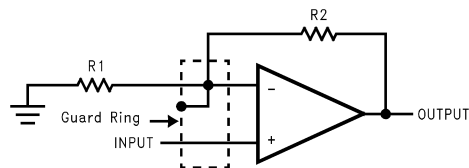

Figure 27. Noninverting Amplifier

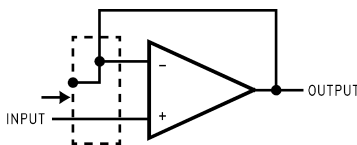
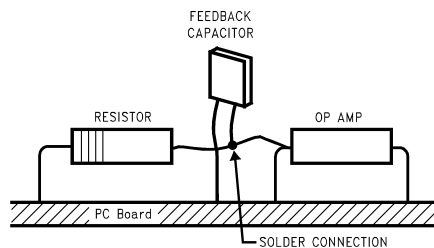

Figure 28. Typical Connections Of Guard Rings

Layout Guidelines (continued)

The designer should be aware that when it is inappropriate to lay out a PCB for the sake of just a few circuits, there is another technique which is even better than a guard ring on a PCB: Do not insert the input pin of the amplifier into the board at all, but bend it up in the air and use only air as an insulator. Air is an excellent insulator. In this case you may have to forego some of the advantages of PCB construction, but the advantages are sometimes well worth the effort of using point-to-point up-in-the-air wiring. See [Figure 29](#).



(Input pins are lifted out of PCB and soldered directly to components. All other pins connected to PCB).

Figure 29. Air Wiring

Another potential source of leakage that might be overlooked is the device package. When the LMC6001 is manufactured, the device is always handled with conductive finger cots. This is to assure that salts and skin oils do not cause leakage paths on the surface of the package. We recommend that these same precautions be adhered to, during all phases of inspection, test and assembly.

10.2 Layout Example

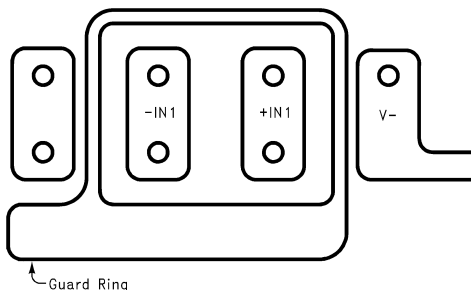

Figure 30. Examples Of Guard Ring In PCB Layout

11 Device and Documentation Support

11.1 Documentation Support

11.1.1 Related Documentation

For related documentation, see the following:

- *LMC660 CMOS Quad Operational Amplifier*, [SNOSBZ3](#)
- *LMC662 CMOS Dual Operational Amplifier*, [SNOSC51](#)

11.2 Related Links

[Table 1](#) lists quick access links. Categories include technical documents, support and community resources, tools and software, and quick access to sample or buy.

Table 1. Related Links

PARTS	PRODUCT FOLDER	SAMPLE & BUY	TECHNICAL DOCUMENTS	TOOLS & SOFTWARE	SUPPORT & COMMUNITY
LMC6001	Click here	Click here	Click here	Click here	Click here

11.3 Community Resources

The following links connect to TI community resources. Linked contents are provided "AS IS" by the respective contributors. They do not constitute TI specifications and do not necessarily reflect TI's views; see TI's [Terms of Use](#).

TI E2E™ Online Community *TI's Engineer-to-Engineer (E2E) Community*. Created to foster collaboration among engineers. At e2e.ti.com, you can ask questions, share knowledge, explore ideas and help solve problems with fellow engineers.

Design Support *TI's Design Support* Quickly find helpful E2E forums along with design support tools and contact information for technical support.

11.4 Trademarks

E2E is a trademark of Texas Instruments.
All other trademarks are the property of their respective owners.

11.5 Electrostatic Discharge Caution



These devices have limited built-in ESD protection. The leads should be shorted together or the device placed in conductive foam during storage or handling to prevent electrostatic damage to the MOS gates.

11.6 Glossary

[SLYZ022](#) — *TI Glossary*.

This glossary lists and explains terms, acronyms, and definitions.

12 Mechanical, Packaging, and Orderable Information

The following pages include mechanical packaging and orderable information. This information is the most current data available for the designated devices. This data is subject to change without notice and revision of this document. For browser-based versions of this data sheet, refer to the left-hand navigation.

PACKAGING INFORMATION

Orderable Device	Status (1)	Package Type	Package Drawing	Pins	Package Qty	Eco Plan (2)	Lead/Ball Finish (6)	MSL Peak Temp (3)	Op Temp (°C)	Device Marking (4/5)	Samples
LMC6001AIN/NOPB	ACTIVE	PDIP	P	8	40	Green (RoHS & no Sb/Br)	CU SN	Level-1-NA-UNLIM	-40 to 85	LMC6001 AIN	Samples
LMC6001BIN/NOPB	ACTIVE	PDIP	P	8	40	Green (RoHS & no Sb/Br)	CU SN	Level-1-NA-UNLIM	-40 to 85	LMC6001 BIN	Samples

(1) The marketing status values are defined as follows:

ACTIVE: Product device recommended for new designs.

LIFEBUY: TI has announced that the device will be discontinued, and a lifetime-buy period is in effect.

NRND: Not recommended for new designs. Device is in production to support existing customers, but TI does not recommend using this part in a new design.

PREVIEW: Device has been announced but is not in production. Samples may or may not be available.

OBSOLETE: TI has discontinued the production of the device.

(2) Eco Plan - The planned eco-friendly classification: Pb-Free (RoHS), Pb-Free (RoHS Exempt), or Green (RoHS & no Sb/Br) - please check <http://www.ti.com/productcontent> for the latest availability information and additional product content details.

TBD: The Pb-Free/Green conversion plan has not been defined.

Pb-Free (RoHS): TI's terms "Lead-Free" or "Pb-Free" mean semiconductor products that are compatible with the current RoHS requirements for all 6 substances, including the requirement that lead not exceed 0.1% by weight in homogeneous materials. Where designed to be soldered at high temperatures, TI Pb-Free products are suitable for use in specified lead-free processes.

Pb-Free (RoHS Exempt): This component has a RoHS exemption for either 1) lead-based flip-chip solder bumps used between the die and package, or 2) lead-based die adhesive used between the die and leadframe. The component is otherwise considered Pb-Free (RoHS compatible) as defined above.

Green (RoHS & no Sb/Br): TI defines "Green" to mean Pb-Free (RoHS compatible), and free of Bromine (Br) and Antimony (Sb) based flame retardants (Br or Sb do not exceed 0.1% by weight in homogeneous material)

(3) MSL, Peak Temp. - The Moisture Sensitivity Level rating according to the JEDEC industry standard classifications, and peak solder temperature.

(4) There may be additional marking, which relates to the logo, the lot trace code information, or the environmental category on the device.

(5) Multiple Device Markings will be inside parentheses. Only one Device Marking contained in parentheses and separated by a "~" will appear on a device. If a line is indented then it is a continuation of the previous line and the two combined represent the entire Device Marking for that device.

(6) Lead/Ball Finish - Orderable Devices may have multiple material finish options. Finish options are separated by a vertical ruled line. Lead/Ball Finish values may wrap to two lines if the finish value exceeds the maximum column width.

Important Information and Disclaimer: The information provided on this page represents TI's knowledge and belief as of the date that it is provided. TI bases its knowledge and belief on information provided by third parties, and makes no representation or warranty as to the accuracy of such information. Efforts are underway to better integrate information from third parties. TI has taken and continues to take reasonable steps to provide representative and accurate information but may not have conducted destructive testing or chemical analysis on incoming materials and chemicals. TI and TI suppliers consider certain information to be proprietary, and thus CAS numbers and other limited information may not be available for release.

In no event shall TI's liability arising out of such information exceed the total purchase price of the TI part(s) at issue in this document sold by TI to Customer on an annual basis.

P (R-PDIP-T8)

PLASTIC DUAL-IN-LINE PACKAGE



- NOTES:
- A. All linear dimensions are in inches (millimeters).
 - B. This drawing is subject to change without notice.
 - C. Falls within JEDEC MS-001 variation BA.

IMPORTANT NOTICE

Texas Instruments Incorporated and its subsidiaries (TI) reserve the right to make corrections, enhancements, improvements and other changes to its semiconductor products and services per JESD46, latest issue, and to discontinue any product or service per JESD48, latest issue. Buyers should obtain the latest relevant information before placing orders and should verify that such information is current and complete. All semiconductor products (also referred to herein as "components") are sold subject to TI's terms and conditions of sale supplied at the time of order acknowledgment.

TI warrants performance of its components to the specifications applicable at the time of sale, in accordance with the warranty in TI's terms and conditions of sale of semiconductor products. Testing and other quality control techniques are used to the extent TI deems necessary to support this warranty. Except where mandated by applicable law, testing of all parameters of each component is not necessarily performed.

TI assumes no liability for applications assistance or the design of Buyers' products. Buyers are responsible for their products and applications using TI components. To minimize the risks associated with Buyers' products and applications, Buyers should provide adequate design and operating safeguards.

TI does not warrant or represent that any license, either express or implied, is granted under any patent right, copyright, mask work right, or other intellectual property right relating to any combination, machine, or process in which TI components or services are used. Information published by TI regarding third-party products or services does not constitute a license to use such products or services or a warranty or endorsement thereof. Use of such information may require a license from a third party under the patents or other intellectual property of the third party, or a license from TI under the patents or other intellectual property of TI.

Reproduction of significant portions of TI information in TI data books or data sheets is permissible only if reproduction is without alteration and is accompanied by all associated warranties, conditions, limitations, and notices. TI is not responsible or liable for such altered documentation. Information of third parties may be subject to additional restrictions.

Resale of TI components or services with statements different from or beyond the parameters stated by TI for that component or service voids all express and any implied warranties for the associated TI component or service and is an unfair and deceptive business practice. TI is not responsible or liable for any such statements.

Buyer acknowledges and agrees that it is solely responsible for compliance with all legal, regulatory and safety-related requirements concerning its products, and any use of TI components in its applications, notwithstanding any applications-related information or support that may be provided by TI. Buyer represents and agrees that it has all the necessary expertise to create and implement safeguards which anticipate dangerous consequences of failures, monitor failures and their consequences, lessen the likelihood of failures that might cause harm and take appropriate remedial actions. Buyer will fully indemnify TI and its representatives against any damages arising out of the use of any TI components in safety-critical applications.

In some cases, TI components may be promoted specifically to facilitate safety-related applications. With such components, TI's goal is to help enable customers to design and create their own end-product solutions that meet applicable functional safety standards and requirements. Nonetheless, such components are subject to these terms.

No TI components are authorized for use in FDA Class III (or similar life-critical medical equipment) unless authorized officers of the parties have executed a special agreement specifically governing such use.

Only those TI components which TI has specifically designated as military grade or "enhanced plastic" are designed and intended for use in military/aerospace applications or environments. Buyer acknowledges and agrees that any military or aerospace use of TI components which have **not** been so designated is solely at the Buyer's risk, and that Buyer is solely responsible for compliance with all legal and regulatory requirements in connection with such use.

TI has specifically designated certain components as meeting ISO/TS16949 requirements, mainly for automotive use. In any case of use of non-designated products, TI will not be responsible for any failure to meet ISO/TS16949.

Products

Audio	www.ti.com/audio
Amplifiers	amplifier.ti.com
Data Converters	dataconverter.ti.com
DLP® Products	www.dlp.com
DSP	dsp.ti.com
Clocks and Timers	www.ti.com/clocks
Interface	interface.ti.com
Logic	logic.ti.com
Power Mgmt	power.ti.com
Microcontrollers	microcontroller.ti.com
RFID	www.ti-rfid.com
OMAP Applications Processors	www.ti.com/omap
Wireless Connectivity	www.ti.com/wirelessconnectivity

Applications

Automotive and Transportation	www.ti.com/automotive
Communications and Telecom	www.ti.com/communications
Computers and Peripherals	www.ti.com/computers
Consumer Electronics	www.ti.com/consumer-apps
Energy and Lighting	www.ti.com/energy
Industrial	www.ti.com/industrial
Medical	www.ti.com/medical
Security	www.ti.com/security
Space, Avionics and Defense	www.ti.com/space-avionics-defense
Video and Imaging	www.ti.com/video

TI E2E Community

e2e.ti.com