



# LUXEON 3535L Line

High efficacy in a 3535 package with full range of CCTs and CRIs

The LUXEON 3535L Line boasts the efficacy and reliability required by the indoor and outdoor illumination markets. It delivers optimized performance in combination with the Quality of Light needed for distributed light source applications in four performance levels.

In addition to offering specified correlated color temperature and color rendering combinations, LUXEON 3535L Line is available in four products:

- |                      |   |                                |
|----------------------|---|--------------------------------|
| LUXEON 3535LS        | – | Entry Flux and Efficacy        |
| LUXEON 3535L         | – | Medium Flux and Efficacy       |
| LUXEON 3535L HE      | – | High Flux and Efficacy         |
| LUXEON 3535L HE Plus | – | High Flux and Highest Efficacy |

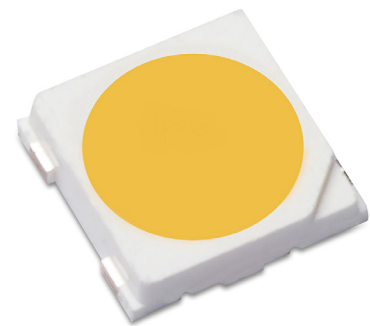

## FEATURES AND BENEFITS

- Supports ENERGY STAR lumen maintenance certification requirements
- Maximum drive current of 300mA delivers superior lumens for reduced LED count for LUXEON 3535L HE and LUXEON 3535L HE Plus
- 1/7<sup>th</sup> ANSI color binning delivers tight color control
- Enables T<sub>s</sub> points of 105°C which allows for higher board temperature
- Full range of CCTs and CRI configurations for design flexibility
- UL-recognized component [E352519]

## PRIMARY APPLICATIONS

- Architectural
- Downlights
- High Bay & Low Bay
- Indoor Area Lighting
- Lamps
- Outdoor
- Specialty Lighting
- Spotlights

# Table of Contents

<b>General Product Information</b> .....	<b>2</b>
Product Test Conditions .....	2
Part Number Nomenclature .....	2
Lumen Maintenance .....	2
Environmental Compliance .....	2
<b>Performance Characteristics</b> .....	<b>3</b>
Product Selection Guide .....	3
Optical Characteristics .....	5
Electrical and Thermal Characteristics .....	5
<b>Absolute Maximum Ratings</b> .....	<b>5</b>
<b>Characteristic Curves</b> .....	<b>6</b>
Spectral Power Distribution Characteristics .....	6
Light Output Characteristics .....	7
Forward Current Characteristics .....	8
Radiation Pattern Characteristics .....	9
<b>Product Bin and Labeling Definitions</b> .....	<b>10</b>
Decoding Product Bin Labeling .....	10
Luminous Flux Bins .....	10
Color Bin Definitions .....	11
Forward Voltage Bins .....	20
<b>Mechanical Dimensions</b> .....	<b>20</b>
<b>Reflow Soldering Guidelines</b> .....	<b>21</b>
JEDEC Moisture Sensitivity .....	21
Solder Pad Design .....	22
<b>Packaging Information</b> .....	<b>22</b>
Pocket Tape Dimensions .....	22
Reel Dimensions .....	23

# General Product Information

## Product Test Conditions

LUXEON 3535L Line LEDs are tested and binned with a 20ms monopulse of 100mA at a junction temperature,  $T_j$ , of 25°C.

## Part Number Nomenclature

Part numbers for LUXEON 3535LS, LUXEON 3535L, and LUXEON 3535L HE follow the convention below:

M X A **B** - P W **C C** - **D E E E**

Where:

- B** – designates minimum CRI (7=70CRI, 8=80CRI and 9=85CRI or 90CRI)
- C C** – designates nominal ANSI CCT (22=2200K, 25=2500K, 27=2700K, 30=3000K, 35=3500K, 40=4000K, 50=5000K, 57=5700K, 65=6500K)
- D** – designates product family in standard parts (0 or 9=LUXEON 3535L, H=LUXEON 3535L HE, S=LUXEON 3535LS)
- E E E** – designates options for detailed product specification

Therefore, the following part number is used for a LUXEON 3535L HE 3000K 80CRI:

M X A **8** - P W **3 0** - **H 0 0 1**

Part numbers for LUXEON 3535L HE Plus follow the convention below:

L 1 3 5 - **A A B B** - C A 3 5 0 0 0 P 1

Where:

- A A** – designates nominal ANSI CCT (27=2700K, 30=3000K, 35=3500K, 40=4000K, 50=5000K, 57=5700K, 65=6500K)
- B B** – designates minimum CRI (8=80CRI)

Therefore, the following part number is used for a LUXEON 3535L HE Plus 3000K 80CRI:

L 1 3 5 - **3 0 8 0** - C A 3 5 0 0 0 P 1

LUXEON 3535L Line is available in four performance levels:

- LUXEON 3535LS – Entry Flux and Efficacy
- LUXEON 3535L – Medium Flux and Efficacy
- LUXEON 3535L HE – High Flux and Efficacy
- LUXEON 3535L HE Plus – High Flux and Highest Efficacy

## Lumen Maintenance

Please contact your local Sales Representative or Lumileds Technical Solutions Manager for more information about the long-term performance of this product.

## Environmental Compliance

Lumileds LLC is committed to providing environmentally friendly products to the solid-state lighting market. LUXEON 3535L Line is compliant to the European Union directives on the restriction of hazardous substances in electronic equipment, namely the RoHS Directive 2011/65/EU and REACH Regulation (EC) 1907/2006. Lumileds LLC will not intentionally add the following restricted materials to its products: lead, mercury, cadmium, hexavalent chromium, polybrominated biphenyls (PBB) or polybrominated diphenyl ethers (PBDE).

# Performance Characteristics

## Product Selection Guide

Table 1. Product performance of LUXEON 3535L Line at 100mA and 65mA,  $T_j=25^{\circ}\text{C}$ .

PRODUCT	NOMINAL CCT <sup>[1]</sup>	MINIMUM CRI <sup>[2]</sup>	LUMINOUS FLUX <sup>[3]</sup> (lm)		TYPICAL LUMINOUS EFFICACY (lm/W)	TYPICAL LUMINOUS FLUX (lm)	TYPICAL LUMINOUS EFFICACY (lm/W)	PART NUMBER
			MINIMUM	TYPICAL				
						100mA		
LUXEON 3535LS	4000K	70	38	44	147	30	158	MXA7-PW40-S001
	5000K	70	38	44	147	30	158	MXA7-PW50-S001
	5700K	70	38	44	147	30	158	MXA7-PW57-S001
	6500K	70	38	46	154	31	166	MXA7-PW65-S001
	2200K	80	26	30	100	20	108	MXA8-PW22-S001
	2500K	80	26	32	107	22	116	MXA8-PW25-S001
	2700K	80	30	38	127	26	137	MXA8-PW27-S001
	3000K	80	30	39	130	26	141	MXA8-PW30-S001
	3500K	80	30	41	137	28	148	MXA8-PW35-S001
	4000K	80	34	43	144	29	155	MXA8-PW40-S001
	5000K	80	34	43	144	29	155	MXA8-PW50-S001
	5700K	80	30	42	140	28	151	MXA8-PW57-S001
	6500K	80	30	42	140	28	151	MXA8-PW65-S001
	2700K	90	26	32	107	22	116	MXA9-PW27-S001
	3000K	90	26	32	107	22	116	MXA9-PW30-S001
LUXEON 3535L	4000K	70	40	49	161	33	176	MXA7-PW40-0000
	5000K	70	40	49	161	33	176	MXA7-PW50-0000
	5700K	70	40	49	161	33	176	MXA7-PW57-0000
	6500K	70	40	47	155	32	168	MXA7-PW65-0000
	2200K	80	28	33	109	22	117	MXA8-PW22-0000
	2500K	80	28	34	112	23	121	MXA8-PW25-0000
	2700K	80	36	44	145	30	156	MXA8-PW27-0000
	3000K	80	34	44	145	30	156	MXA8-PW30-0000
	3500K	80	34	44	145	30	156	MXA8-PW35-0000
	4000K	80	36	46	151	31	163	MXA8-PW40-0000
	5000K	80	36	47	155	32	167	MXA8-PW50-0000
	5700K	80	36	45	148	30	160	MXA8-PW57-0000
	6500K	80	36	45	148	30	160	MXA8-PW65-0000
	2700K	85	32	36	119	24	128	MXA9-PW27-0000
	4000K	85	34	40	132	27	142	MXA9-PW40-0000
2700K	90	31	36	119	24	128	MXA9-PW27-9000	
3000K	90	31	36	119	24	128	MXA9-PW30-0000	

**Notes for Table 1:**

1. Correlated color temperature is based upon mounted die on highly reflective surface at  $T=25^{\circ}\text{C}$ .
2. Typical CRI is approximately 2 points higher than the minimum CRI specified, but this is not guaranteed.
3. Lumileds maintains a tolerance of  $\pm 2$  on CRI and  $\pm 6.5\%$  on luminous flux measurements.

Table 1. Product performance of LUXEON 3535L Line at 100mA and 65mA, T<sub>j</sub>=25°C (continued) .

PRODUCT	NOMINAL CCT <sup>[1]</sup>	MINIMUM CRI <sup>[2]</sup>	LUMINOUS FLUX <sup>[3]</sup> (lm)		TYPICAL LUMINOUS EFFICACY (lm/W)	TYPICAL LUMINOUS FLUX (lm)	TYPICAL LUMINOUS EFFICACY (lm/W)	PART NUMBER
			MINIMUM	TYPICAL				
						100mA		
LUXEON 3535L HE	4000K	70	42	51	176	34	186	MXA7-PW40-H001
	5000K	70	42	51	176	34	186	MXA7-PW50-H001
	5700K	70	42	51	176	34	186	MXA7-PW57-H001
	6500K	70	42	51	176	34	186	MXA7-PW65-H001
	2200K	80	30	35	121	23	128	MXA8-PW22-H001
	2500K	80	30	36	125	24	132	MXA8-PW25-H001
	2700K	80	38	46	164	32	172	MXA8-PW27-H001
	3000K	80	38	46	164	32	172	MXA8-PW30-H001
	3500K	80	40	46	164	32	172	MXA8-PW35-H001
	4000K	80	42	52	183	33	190	MXA8-PW40-H001
	5000K	80	42	51	183	33	190	MXA8-PW50-H001
	5700K	80	42	51	183	33	190	MXA8-PW57-H001
	6500K	80	42	51	183	33	190	MXA8-PW65-H001
	2700K	90	32	37	128	25	135	MXA9-PW27-H001
	3000K	90	32	37	128	25	135	MXA9-PW30-H001
	3500K	90	32	40	138	27	146	MXA9-PW35-H001
	4000K	90	32	41	142	27	150	MXA9-PW40-H001
	5000K	90	32	41	142	27	150	MXA9-PW50-H001
	5700K	90	32	40	138	27	146	MXA9-PW57-H001
	6500K	90	32	40	138	27	146	MXA9-PW65-H001
LUXEON 3535L HE Plus	2700K	80	44	47	165	30	172	L135-2780CA35000P1
	3000K	80	44	47	165	30	172	L135-3080CA35000P1
	3500K	80	44	47	165	30	172	L135-3580CA35000P1
	4000K	80	48	53	186	34	194	L135-4080CA35000P1
	5000K	80	48	52	186	34	194	L135-5080CA35000P1
	5700K	80	48	52	186	34	194	L135-5780CA35000P1
	6500K	80	48	52	186	34	194	L135-6580CA35000P1

Notes for Table 1:

1. Correlated color temperature is based upon mounted die on highly reflective surface at T=25°C.
2. Typical CRI is approximately 2 points higher than the minimum CRI specified, but this is not guaranteed.
3. Lumileds maintains a tolerance of ±2 on CRI and ±6.5% on luminous flux measurements.

# Optical Characteristics

Table 2. Optical characteristics for LUXEON 3535L Line at 100mA, T<sub>j</sub>=25°C.

PART NUMBER	TYPICAL TOTAL INCLUDED ANGLE <sup>[1]</sup>	TYPICAL VIEWING ANGLE <sup>[2]</sup>
MXAx-PWxx-xxxx	140°	115°
L135-xxxxCA35000P1	140°	115°

**Notes for Table 2:**

- Total angle at which 90% of total luminous flux is captured.
- Viewing angle is the off axis angle from the LED centerline where the luminous intensity is ½ of the peak value.

# Electrical and Thermal Characteristics

Table 3. Electrical and thermal characteristics for LUXEON 3535L Line at 100mA, T<sub>j</sub>=25°C.

PART NUMBER	FORWARD VOLTAGE <sup>[1]</sup> (V <sub>f</sub> )			TYPICAL TEMPERATURE COEFFICIENT OF FORWARD VOLTAGE <sup>[2]</sup> (mV/°C)	TYPICAL THERMAL RESISTANCE—JUNCTION TO SOLDER PAD (°C/W)
	MINIMUM	TYPICAL	MAXIMUM		
MXAx-PWxx-S001	2.8	3.0	3.4	-2.0 to -4.0	22
MXAx-PWxx-0000	2.8	3.0	3.4	-2.0 to -4.0	18
MXAx-PWxx-H001	2.7	2.9	3.2	-2.0 to -4.0	16
L135-xxxxCA35000P1	2.7	2.8	3.1	-2.0 to -4.0	14

**Notes for Table 3:**

- Lumileds maintains a tolerance of ±0.06V on forward voltage measurements.
- Measured between 25°C and 110°C.

# Absolute Maximum Ratings

Table 4. Absolute maximum ratings for LUXEON 3535L Line.

PARAMETER	MAXIMUM PERFORMANCE
DC Forward Current <sup>[1,2]</sup>	200mA for MxAx-PWxx-S001 and MxAx-PWxx-0000 300mA for MxAx-PWxx-H001 and L135-xxxxCA35000P1
Peak Pulsed Forward Current <sup>[1,3]</sup>	240mA for MxAx-PWxx-S001 and MxAx-PWxx-0000 350mA for MxAx-PWxx-H001 and L135-xxxxCA35000P1
LED Junction Temperature <sup>[1]</sup> (DC & Pulse)	125°C
ESD Sensitivity (ANSI/ESDA/JEDEC JS-001-2012)	Class 2
Operating Case Temperature <sup>[1]</sup>	-40°C to 105°C
LED Storage Temperature	-40°C to 105°C
Soldering Temperature	JEDEC 020D 260°C
Allowable Reflow Cycles	3
Reverse Voltage (V <sub>reverse</sub> )	-5V

**Notes for Table 4:**

- Residual periodic variations due to power conversion from alternating current (AC) to direct current (DC), also called "ripple," are acceptable if the following conditions are met:
  - The frequency of the ripple current is 100Hz or higher
  - The average current for each cycle does not exceed the maximum allowable DC forward current
  - The maximum amplitude of the ripple does not exceed the maximum peak pulsed forward current
- At 10% duty cycle with pulse width of 10ms.
- Proper current derating must be observed to maintain the junction temperature below the maximum allowable junction temperature.

# Characteristic Curves

## Spectral Power Distribution Characteristics

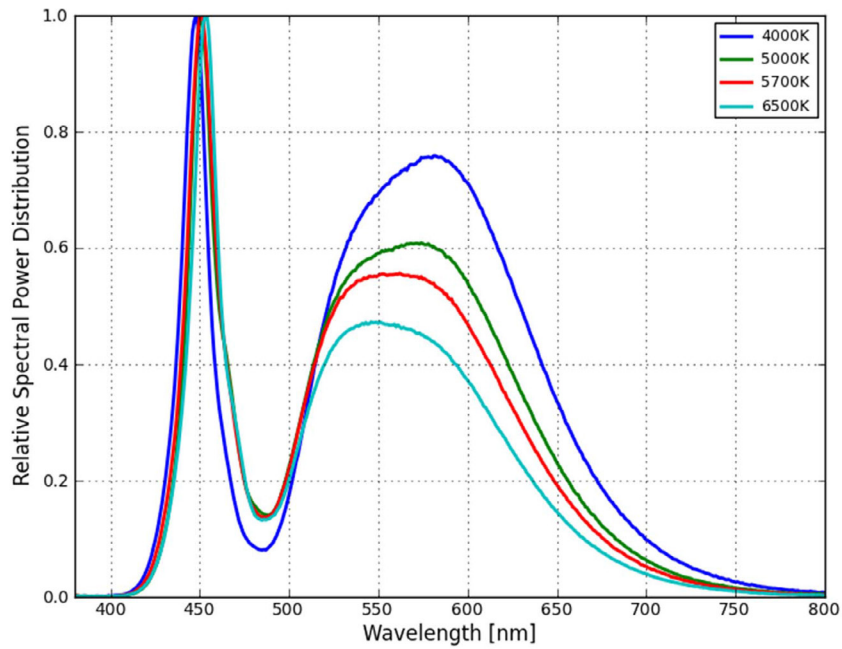

Figure 1a. Typical normalized power vs. wavelength for 70CRI LUXEON 3535L Line at 100mA,  $T_j=25^\circ\text{C}$ .

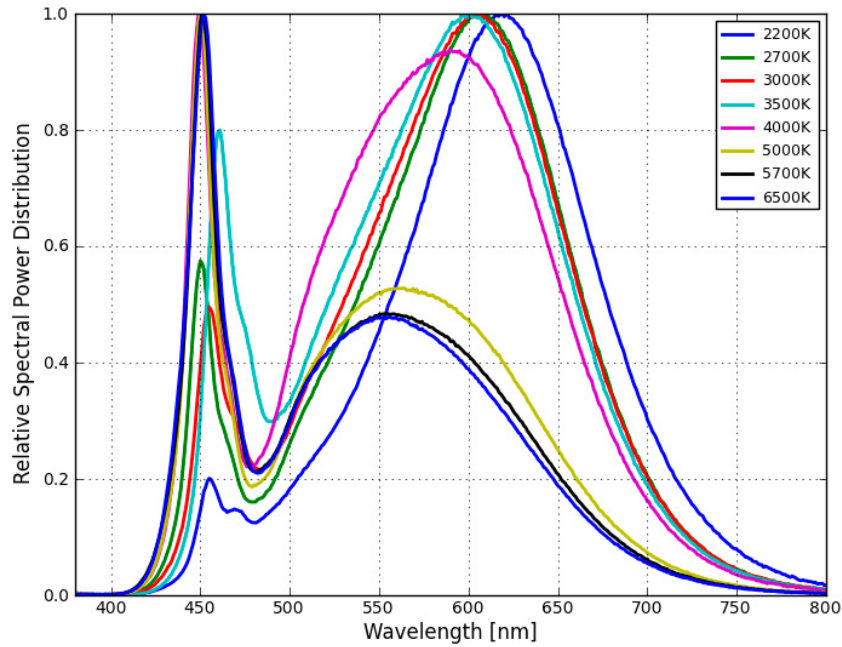

Figure 1b. Typical normalized power vs. wavelength for 80CRI LUXEON 3535L Line at 100mA,  $T_j=25^\circ\text{C}$ .



Figure 1c. Typical normalized power vs. wavelength for 90CRI LUXEON 3535L Line at 100mA,  $T_j=25^\circ\text{C}$ .

## Light Output Characteristics

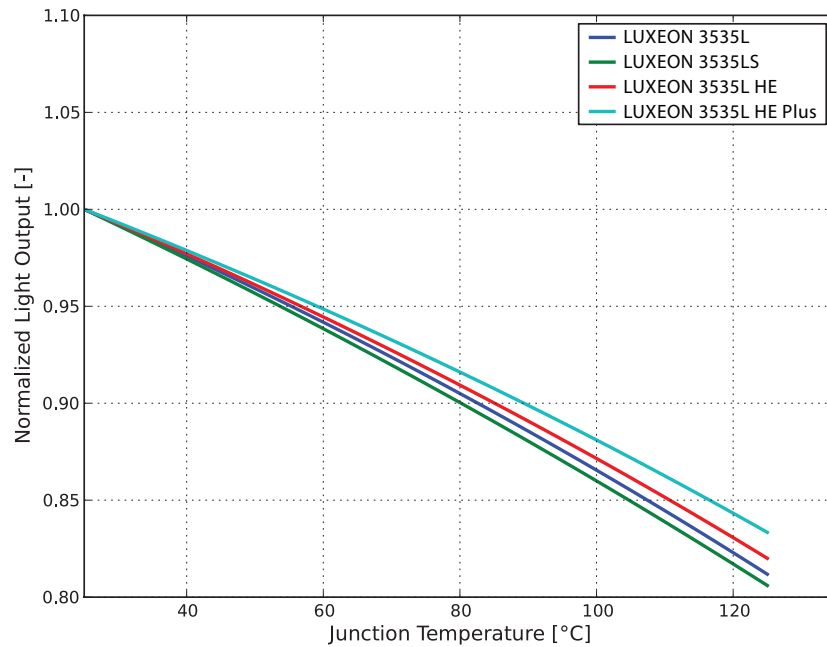

Figure 2. Typical normalized light output vs. junction temperature for LUXEON 3535L Line at 100mA.



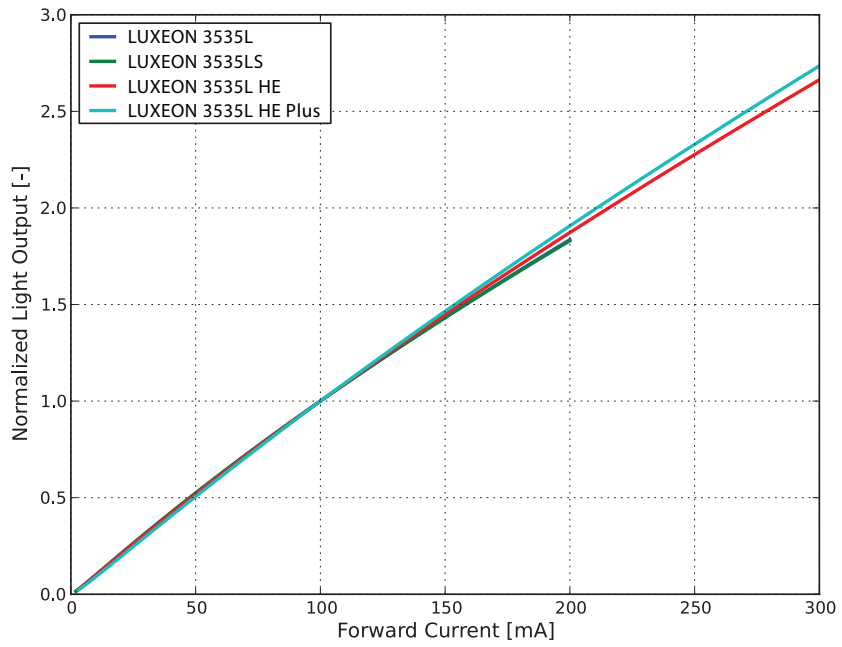

Figure 3. Typical normalized light output vs. forward current for LUXEON 3535L Line at  $T_j=25^\circ\text{C}$ .

## Forward Current Characteristics

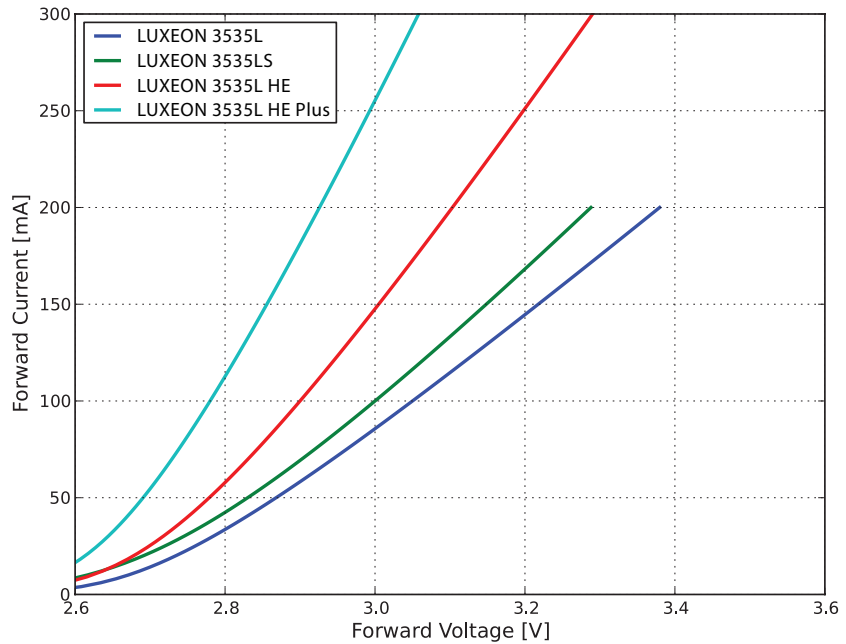

Figure 4. Typical forward current vs. forward voltage for LUXEON 3535L Line at  $T_j=25^\circ\text{C}$ .

# Radiation Pattern Characteristics

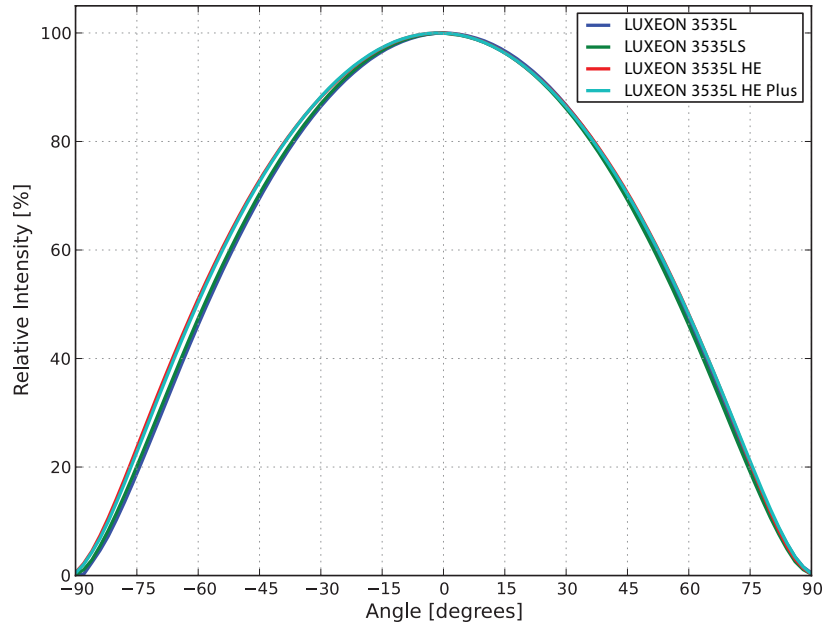

Figure 5. Typical radiation pattern for LUXEON 3535L Line at 100mA,  $T_j=25^{\circ}\text{C}$ .

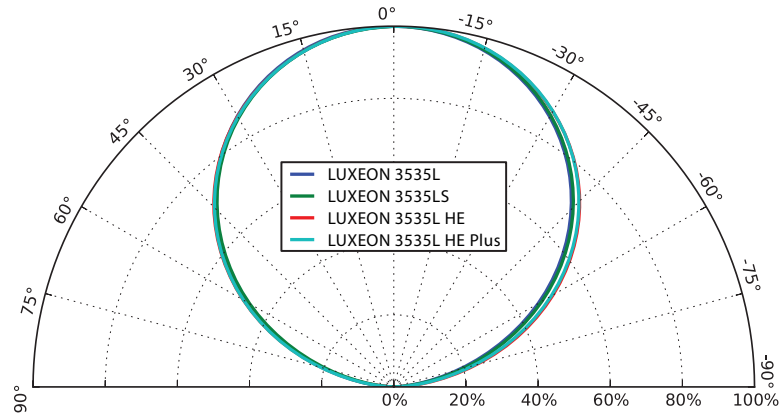

Figure 6. Typical polar radiation pattern for LUXEON 3535L Line at 100mA,  $T_j=25^{\circ}\text{C}$ .

# Product Bin and Labeling Definitions

## Decoding Product Bin Labeling

In the manufacturing of semiconductor products, there are variations in performance around the average values given in the technical datasheet. For this reason, Lumileds bins LED components for luminous flux or radiometric power, color point, peak or dominant wavelength and forward voltage.

LUXEON 3535L Line LEDs are labeled using a 4 or 5-digit alphanumeric CAT code following the format below:

**A B C D** or **A x B C D**

Where:

- A** – designates luminous flux bin (example: M=36 to 40 lumens, R=48 to 52 lumens)
- x** – designates internal Lumileds code
- B C** – designates color bin (example: 7Z, 71, 72, 73, 74, 75, 76) for 3000K parts
- D** – designates forward voltage bin (example: S=2.70 to 2.80V, T=2.80 to 2.90V)

Therefore, a LUXEON 3535L HE with a lumen range of 36 to 40, color bin of 7Z and a forward voltage range of 2.80 to 2.90V has the following CAT code:

**M 7 Z T**

## Luminous Flux Bins

Table 5 lists the standard photometric luminous flux bins for LUXEON 3535L Line emitters. Although several bins are outlined, product availability in a particular bin varies by production run and by product performance. Not all bins are available in all CCTs.

Table 5. Luminous flux bin definitions for LUXEON 3535L Line.

BIN	LUMINOUS FLUX <sup>[1]</sup> (lm)	
	MINIMUM	MAXIMUM
J	24	28
K	28	32
L	32	36
M	36	40
P	40	44
Q	44	48
R	48	52
S	52	56
T	56	60

Notes for Table 5:

1. Lumileds maintains a tolerance of  $\pm 6.5\%$  on luminous flux measurements.

# Color Bin Definitions

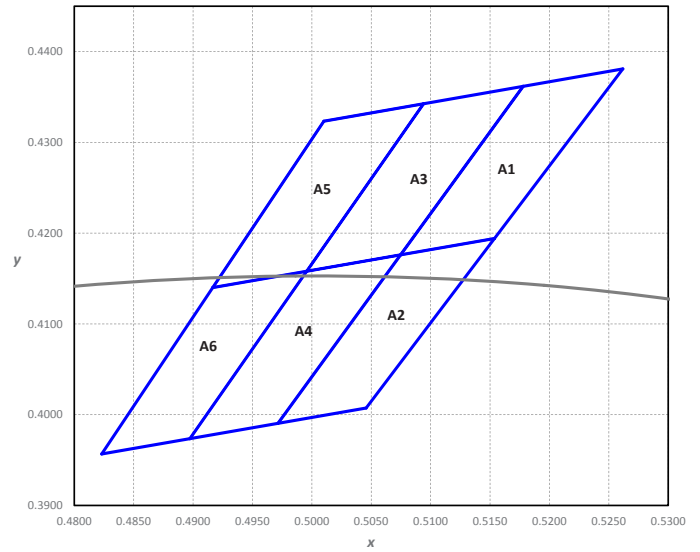
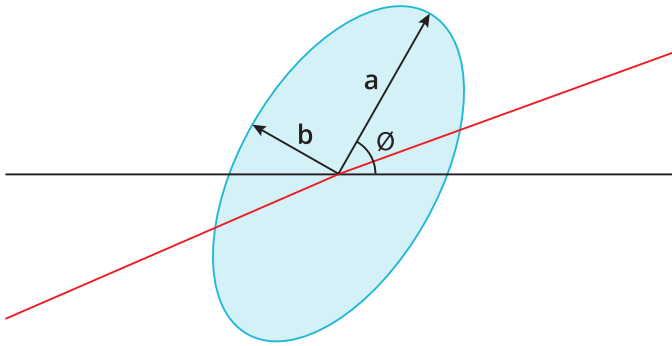

Figure 7. 3- and 5-step MacAdam ellipse illustration for Tables 6a-6i.

Figure 8a. Color bin structure for LUXEON 3535L Line 2200K.

Table 6a. Color bin definitions for MXAx-PW22-xxxx.

BIN	x	y	BIN	x	y
A1	0.5178	0.4362	A4	0.4996	0.4158
	0.5262	0.4381		0.5075	0.4176
	0.5154	0.4194		0.4972	0.3990
	0.5075	0.4176		0.4897	0.3974
A2	0.5075	0.4176	A5	0.5010	0.4323
	0.5154	0.4194		0.5094	0.4343
	0.5046	0.4007		0.4996	0.4158
	0.4972	0.3990		0.4917	0.4140
A3	0.5094	0.4343	A6	0.4917	0.4140
	0.5178	0.4362		0.4996	0.4158
	0.5075	0.4176		0.4897	0.3974
	0.4996	0.4158		0.4823	0.3957

**Notes for Table 6a:**

1. Lumileds maintains a tolerance of  $\pm 0.007$  on x and y coordinates in the CIE 1931 color space.
2. Tested and binned at 25°C and  $I_f=100\text{mA}$ .

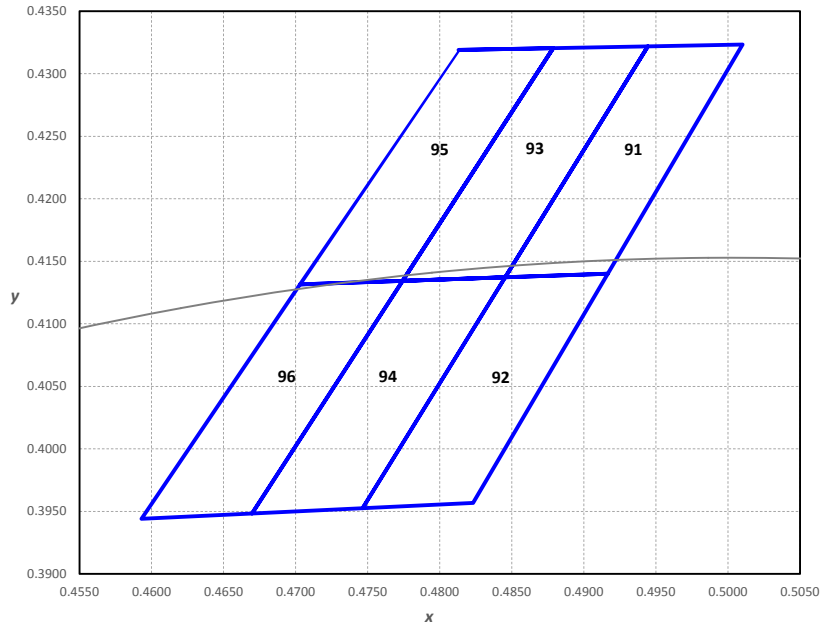

Figure 8b. Color bin structure for LUXEON 3535L Line 2500K.

Table 6b. Color bin definitions for MXAx-PW25-xxxx.

BIN	x	y	BIN	x	y
91	0.4944	0.4322	94	0.4774	0.4134
	0.5010	0.4323		0.4845	0.4137
	0.4917	0.4140		0.4746	0.3952
	0.4845	0.4137		0.4670	0.3948
92	0.4845	0.4137	95	0.4813	0.4319
	0.4917	0.4140		0.4879	0.4320
	0.4823	0.3957		0.4774	0.4134
	0.4746	0.3952		0.4703	0.4132
93	0.4879	0.4320	96	0.4703	0.4132
	0.4944	0.4322		0.4774	0.4134
	0.4845	0.4137		0.4670	0.3948
	0.4774	0.4134		0.4593	0.3944

Notes for Table 6b:

1. Lumileds maintains a tolerance of  $\pm 0.007$  on x and y coordinates in the CIE 1931 color space.
2. Tested and binned at 25°C and  $I_f=100\text{mA}$ .

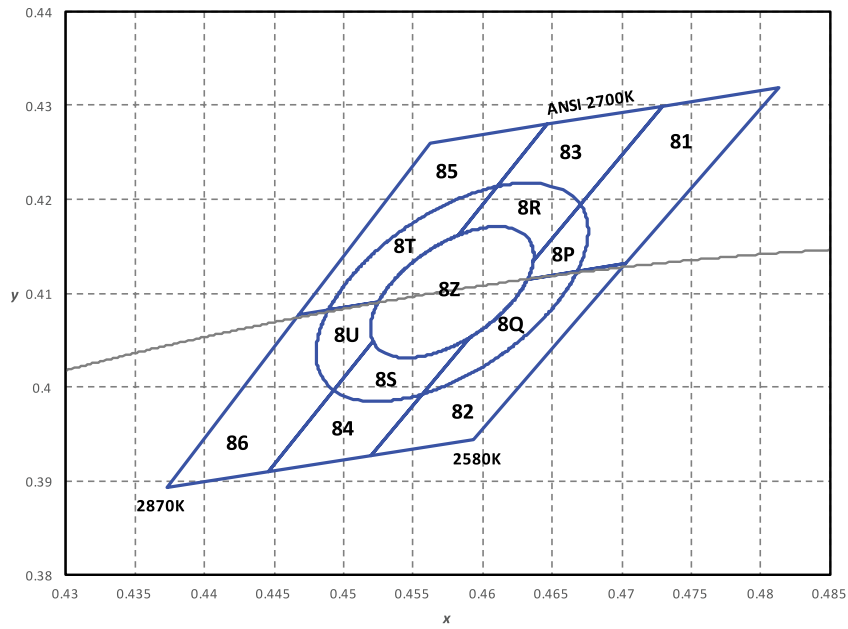

Figure 8c. Color bin structure for LUXEON 3535L Line 2700K.

Table 6c-1. Color bin definitions for LUXEON 3535L Line for MXAx-PW27-xxxx and L135-27xxCA35000P1.

BIN	x	y	BIN	x	y
81	0.4625	0.4113	84	0.4446	0.3910
	0.4729	0.4299		0.4546	0.4095
	0.4813	0.4319		0.4625	0.4113
	0.4703	0.4132		0.4520	0.3927
82	0.4520	0.3927	85	0.4468	0.4077
	0.4625	0.4113		0.4562	0.4260
	0.4703	0.4132		0.4646	0.4280
	0.4593	0.3944		0.4546	0.4095
83	0.4546	0.4095	86	0.4373	0.3893
	0.4646	0.4280		0.4468	0.4077
	0.4729	0.4299		0.4546	0.4095
	0.4625	0.4113		0.4446	0.3910

Table 6c-2. 3- and 5-step MacAdam ellipse color bin definitions for MXAx-PW27-xxxx and L135-27xxCA35000P1.

NOMINAL CCT	COLOR SPACE	CENTER POINT (cx, cy)	MAJOR AXIS, a	MINOR AXIS, b	ELLIPSE ROTATION ANGLE, $\theta$
2700K	Single 3-Step MacAdam ellipse	(0.4578, 0.4101)	0.0081	0.0042	53.70°
2700K	Single 5-Step MacAdam ellipse <sup>[3]</sup>	(0.4578, 0.4101)	0.0135	0.0070	53.70°

Notes for Tables 6c-1 and 6c-2:

1. Lumileds maintains a tolerance of  $\pm 0.007$  on x and y coordinates in the CIE 1931 color space.
2. Tested and binned at 25°C and  $I_f=100\text{mA}$ .
3. LUXEON 3535LS is not available in 5-step MacAdam ellipse.

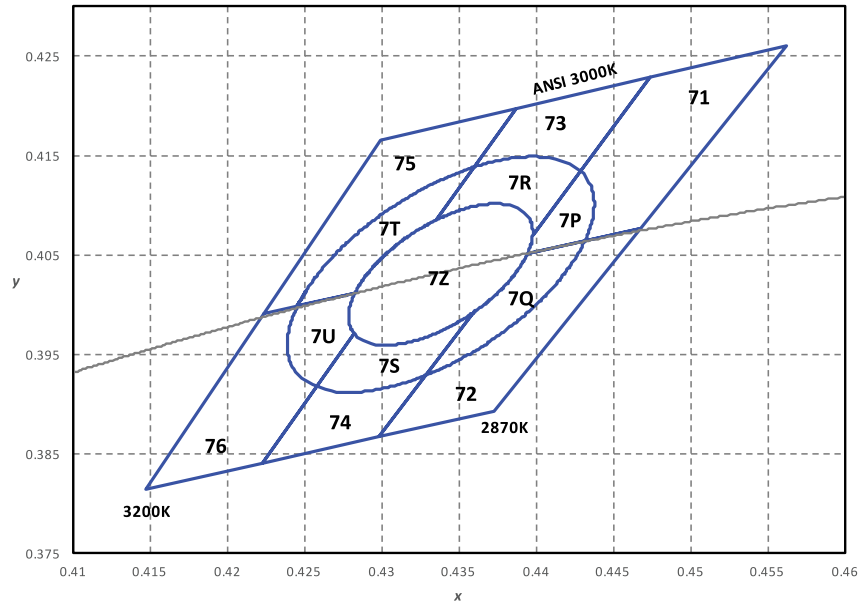

Figure 8d. Color bin structure for LUXEON 3535L Line 3000K.

Table 6d-1. Color bin definitions for LUXEON 3535L Line for MXAx-PW30-xxxx and L135-30xxCA35000P1.

BIN	x	y	BIN	x	y
71	0.4386	0.4048	74	0.4222	0.3840
	0.4474	0.4228		0.4305	0.4019
	0.4562	0.4260		0.4386	0.4048
	0.4468	0.4077		0.4298	0.3867
72	0.4298	0.3867	75	0.4223	0.3990
	0.4386	0.4048		0.4299	0.4165
	0.4468	0.4077		0.4387	0.4197
	0.4373	0.3893		0.4305	0.4019
73	0.4305	0.4019	76	0.4147	0.3814
	0.4387	0.4197		0.4223	0.3990
	0.4474	0.4228		0.4305	0.4019
	0.4386	0.4048		0.4222	0.3840

Table 6d-2. 3- and 5-step MacAdam ellipse color bin definitions for MXAx-PW30-xxxx and L135-30xxCA35000P1.

NOMINAL CCT	COLOR SPACE	CENTER POINT (cx, cy)	MAJOR AXIS, a	MINOR AXIS, b	ELLIPSE ROTATION ANGLE, $\theta$
3000K	Single 3-Step MacAdam ellipse	(0.4338, 0.4030)	0.00834	0.00408	53.22°
3000K	Single 5-Step MacAdam ellipse <sup>[3]</sup>	(0.4338, 0.4030)	0.01390	0.00680	53.22°

Notes for Tables 6d-1 and 6d-2:

- Lumileds maintains a tolerance of  $\pm 0.007$  on x and y coordinates in the CIE 1931 color space.
- Tested and binned at 25°C and  $I_f=100\text{mA}$ .
- LUXEON 3535LS is not available in 5-step MacAdam ellipse.

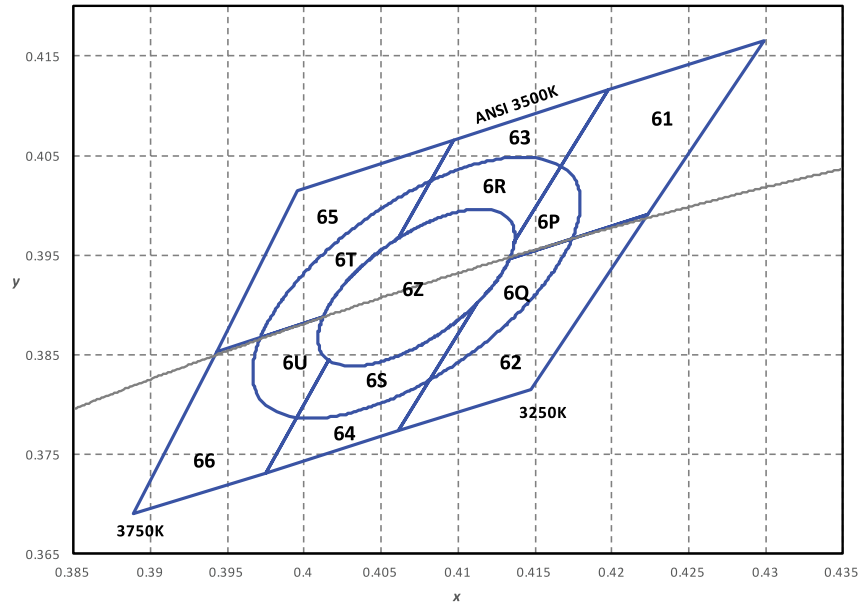

Figure 8e. Color bin structure for LUXEON 3535L Line 3500K.

Table 6e-1. Color bin definitions for LUXEON 3535L Line for MXAx-PW35-xxxx and L135-35xxCA35000P1.

BIN	x	y	BIN	x	y
61	0.4130	0.3944	64	0.3975	0.3731
	0.4198	0.4115		0.4036	0.3898
	0.4299	0.4165		0.4130	0.3944
	0.4223	0.3990		0.4061	0.3773
62	0.4061	0.3773	65	0.3943	0.3853
	0.4130	0.3944		0.3996	0.4015
	0.4223	0.3990		0.4097	0.4065
	0.4147	0.3814		0.4036	0.3898
63	0.4036	0.3898	66	0.3889	0.3690
	0.4097	0.4065		0.3943	0.3853
	0.4198	0.4115		0.4036	0.3898
	0.4130	0.3944		0.3975	0.3731

Table 6e-2. 3- and 5-step MacAdam ellipse color bin definitions for MXAx-PW35-xxxx and L135-35xxCA35000P1.

NOMINAL CCT	COLOR SPACE	CENTER POINT (cx, cy)	MAJOR AXIS, a	MINOR AXIS, b	ELLIPSE ROTATION ANGLE, $\theta$
3500K	Single 3-Step MacAdam Ellipse	(0.4073, 0.3917)	0.00927	0.00414	54.00°
3500K	Single 5-Step MacAdam ellipse <sup>[3]</sup>	(0.4073, 0.3917)	0.01545	0.00690	54.00°

Notes for Tables 6e-1 and 6e-2:

- Lumileds maintains a tolerance of  $\pm 0.007$  on x and y coordinates in the CIE 1931 color space.
- Tested and binned at 25°C and  $I_f=100\text{mA}$ .
- LUXEON 3535LS is not available in 5-step MacAdam ellipse.



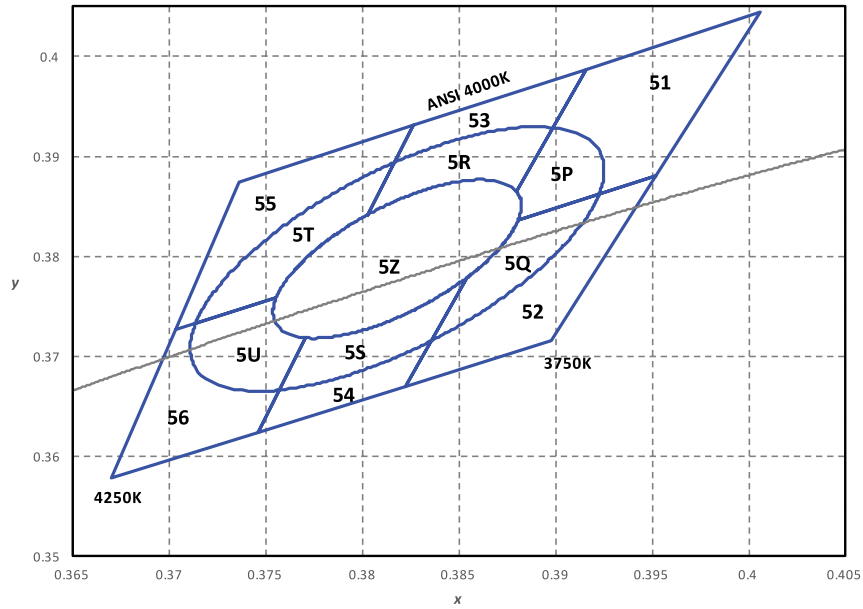

Figure 8f. Color bin structure for LUXEON 3535L Line 4000K.

Table 6f-1. Color bin definitions for LUXEON 3535L Line for MXAx-PW40-xxxx and L135-40xxCA35000P1.

BIN	x	y	BIN	x	y
51	0.3869	0.3829	54	0.3746	0.3624
	0.3916	0.3987		0.3786	0.3777
	0.4006	0.4044		0.3869	0.3829
	0.3952	0.3880		0.3822	0.3670
52	0.3822	0.3670	55	0.3703	0.3726
	0.3869	0.3829		0.3736	0.3874
	0.3952	0.3880		0.3826	0.3931
	0.3898	0.3716		0.3786	0.3777
53	0.3786	0.3777	56	0.3670	0.3578
	0.3826	0.3931		0.3703	0.3726
	0.3916	0.3987		0.3786	0.3777
	0.3869	0.3829		0.3746	0.3624

Table 6f-2. 3- and 5-step MacAdam ellipse color bin definitions for MXAx-PW40-xxxx and L135-40xxCA35000P1.

NOMINAL CCT	COLOR SPACE	CENTER POINT (cx, cy)	MAJOR AXIS, a	MINOR AXIS, b	ELLIPSE ROTATION ANGLE, $\theta$
4000K	Single 3-Step MacAdam ellipse	(0.3818, 0.3797)	0.00939	0.00402	53.72°
4000K	Single 5-Step MacAdam ellipse <sup>[3]</sup>	(0.3818, 0.3797)	0.01565	0.00670	53.72°

Notes for Tables 6f-1 and 6f-2:

1. Lumileds maintains a tolerance of  $\pm 0.007$  on x and y coordinates in the CIE 1931 color space.
2. Tested and binned at 25°C and  $I_f=100\text{mA}$ .
3. LUXEON 3535LS is not available in 5-step MacAdam ellipse.

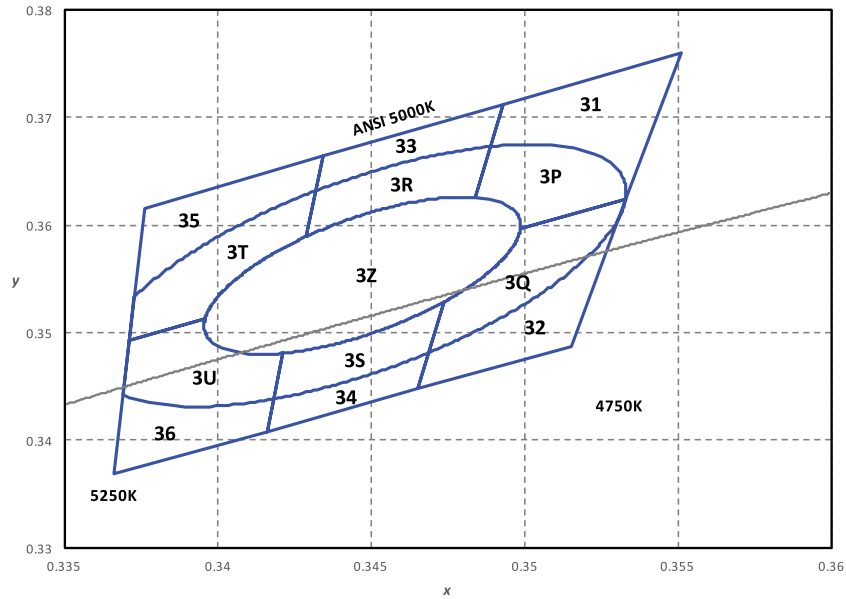

Figure 8g. Color bin structure for LUXEON 3535L Line 5000K.

Table 6g-1. Color bin definitions for LUXEON 3535L Line for MXAx-PW50-xxxx and L135-50xxCA35000P1.

BIN	x	y	BIN	x	y
31	0.3479	0.3580	34	0.3416	0.3408
	0.3493	0.3712		0.3425	0.3536
	0.3551	0.3760		0.3479	0.3580
	0.3533	0.3624		0.3465	0.3448
32	0.3465	0.3448	35	0.3371	0.3493
	0.3479	0.3580		0.3376	0.3616
	0.3533	0.3624		0.3434	0.3664
	0.3515	0.3487		0.3425	0.3536
33	0.3425	0.3536	36	0.3366	0.3369
	0.3434	0.3664		0.3371	0.3493
	0.3493	0.3712		0.3425	0.3536
	0.3479	0.3580		0.3416	0.3408

Table 6g-2. 3- and 5-step MacAdam ellipse color bin definitions for MXAx-PW50-xxxx and L135-50xxCA35000P1.

NOMINAL CCT	COLOR SPACE	CENTER POINT (cx, cy)	MAJOR AXIS, a	MINOR AXIS, b	ELLIPSE ROTATION ANGLE, $\theta$
5000K	Single 3-Step MacAdam ellipse	(0.3447, 0.3553)	0.00822	0.00354	59.62°
5000K	Single 5-Step MacAdam ellipse <sup>[3]</sup>	(0.3447, 0.3553)	0.01370	0.00590	59.62°

Notes for Tables 6g-1 and 6g-2:

- Lumileds maintains a tolerance of  $\pm 0.007$  on x and y coordinates in the CIE 1931 color space.
- Tested and binned at 25°C and  $I_f=100\text{mA}$ .
- LUXEON 3535LS is not available in 5-step MacAdam ellipse.

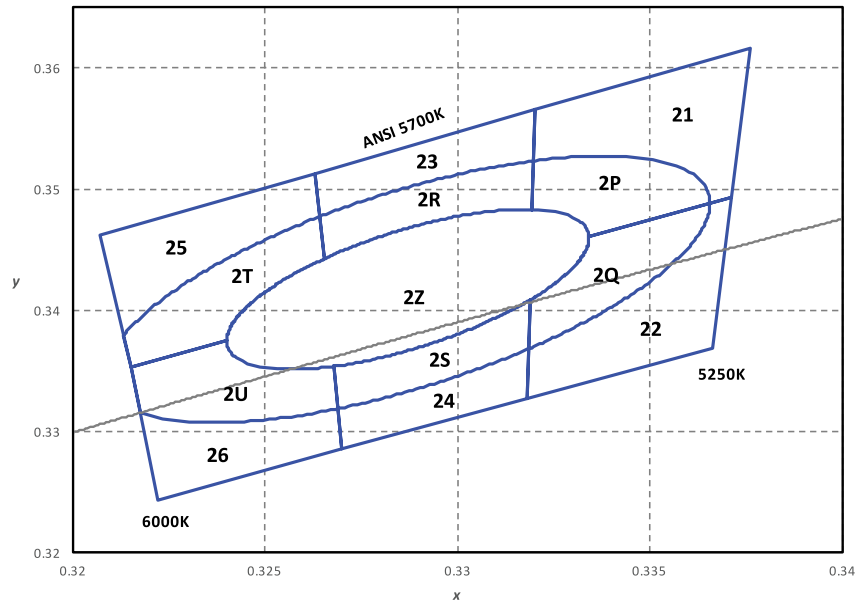

Figure 8h. Color bin structure for LUXEON 3535L Line 5700K.

Table 6h-1. Color bin definitions for LUXEON 3535L Line for MXAx-PW57-xxxx and L135-57xxCA35000P1.

BIN	x	y	BIN	x	y
21	0.3319	0.3446	24	0.3270	0.3285
	0.3320	0.3565		0.3267	0.3399
	0.3376	0.3616		0.3319	0.3446
	0.3371	0.3493		0.3318	0.3327
22	0.3318	0.3327	25	0.3215	0.3353
	0.3319	0.3446		0.3207	0.3462
	0.3371	0.3493		0.3263	0.3513
23	0.3366	0.3369	26	0.3267	0.3399
	0.3267	0.3399		0.3222	0.3243
	0.3263	0.3513		0.3215	0.3353
	0.3320	0.3565		0.3267	0.3399
	0.3319	0.3446		0.3270	0.3285

Table 6h-2. 3- and 5-step MacAdam ellipse color bin definitions for MXAx-PW57-xxxx and L135-57xxCA35000P1.

NOMINAL CCT	COLOR SPACE	CENTER POINT (cx, cy)	MAJOR AXIS, a	MINOR AXIS, b	ELLIPSE ROTATION ANGLE, $\theta$
5700K	Single 3-Step MacAdam ellipse	(0.3287, 0.3417)	0.00746	0.00320	59.09°
5700K	Single 5-Step MacAdam ellipse <sup>[3]</sup>	(0.3287, 0.3417)	0.01243	0.00533	59.09°

Notes for Tables 6h-1 and 6h-2:

- Lumileds maintains a tolerance of  $\pm 0.007$  on x and y coordinates in the CIE 1931 color space.
- Tested and binned at 25°C and  $I_f=100\text{mA}$ .
- LUXEON 3535LS is not available in 5-step MacAdam ellipse.

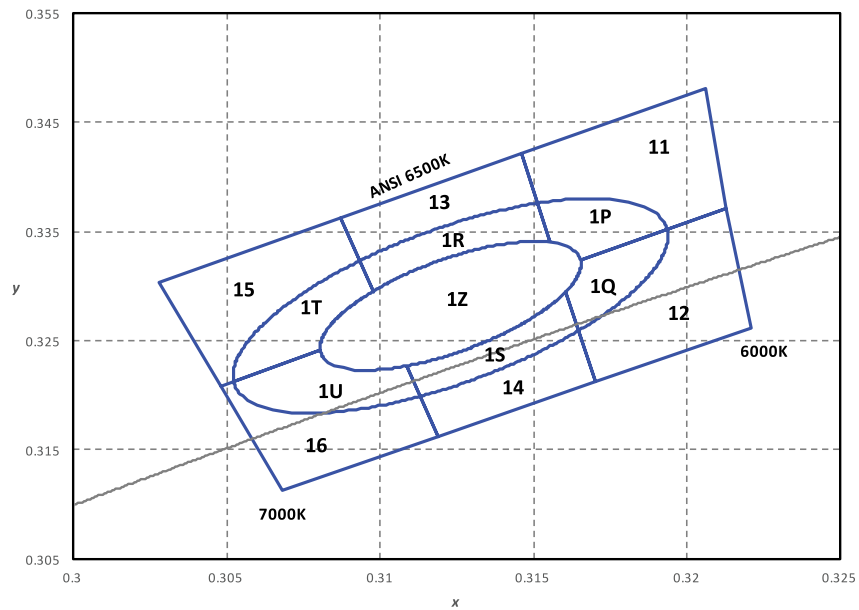

Figure 8i. Color bin structure for LUXEON 3535L Line 6500K.

Table 6i-1. Color bin definitions for LUXEON 3535L Line for MXAx-PW65-xxxx and L135-65xxCA35000P1.

BIN	x	y	BIN	x	y
11	0.3158	0.3317	14	0.3119	0.3162
	0.3146	0.3422		0.3103	0.3263
	0.3206	0.3481		0.3158	0.3317
	0.3213	0.3371		0.3170	0.3212
12	0.3170	0.3212	15	0.3048	0.3209
	0.3158	0.3317		0.3028	0.3304
	0.3213	0.3371		0.3087	0.3363
	0.3221	0.3261		0.3103	0.3263
13	0.3103	0.3263	16	0.3068	0.3113
	0.3087	0.3363		0.3048	0.3209
	0.3146	0.3422		0.3103	0.3263
	0.3158	0.3317		0.3119	0.3162

Table 6i-2. 3- and 5-step MacAdam ellipse color bin definitions for MXAx-PW65-xxxx and L135-65xxCA35000P1.

NOMINAL CCT	COLOR SPACE	CENTER POINT (cx, cy)	MAJOR AXIS, a	MINOR AXIS, b	ELLIPSE ROTATION ANGLE, $\theta$
6500K	Single 3-Step MacAdam ellipse	(0.3123, 0.3282)	0.00669	0.00285	58.57°
6500K	Single 5-Step MacAdam ellipse <sup>[3]</sup>	(0.3123, 0.3282)	0.01115	0.00475	58.57°

Notes for Tables 6i-1 and 6i-2:

1. Lumileds maintains a tolerance of  $\pm 0.007$  on x and y coordinates in the CIE 1931 color space.
2. Tested and binned at 25°C and  $I_f=100\text{mA}$ .
3. LUXEON 3535LS is not available in 5-step MacAdam ellipse.

# Forward Voltage Bins

Table 7. Forward voltage bin definitions for LUXEON 3535L Line.

BIN	FORWARD VOLTAGE <sup>[1]</sup> (V <sub>f</sub> )	
	MINIMUM	MAXIMUM
S	2.70	2.80
T	2.80	2.90
V	2.90	3.00
W	3.00	3.10
X	3.10	3.20
Y	3.20	3.30

**Notes for Table 7:**

1. Lumileds maintains a tolerance of  $\pm 0.06V$  on forward voltage measurements.
2. Tested and binned at 25°C and I<sub>f</sub>=100mA.

# Mechanical Dimensions

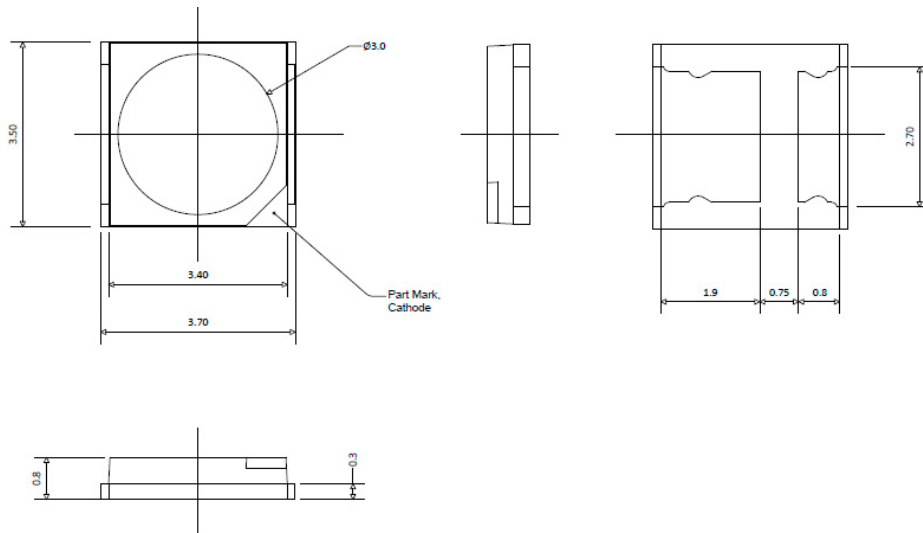

Figure 9. Mechanical dimensions for LUXEON 3535L Line.

**Notes for Figure 9:**

1. Drawings are not to scale.
2. All dimensions are in millimeters.

# Reflow Soldering Guidelines

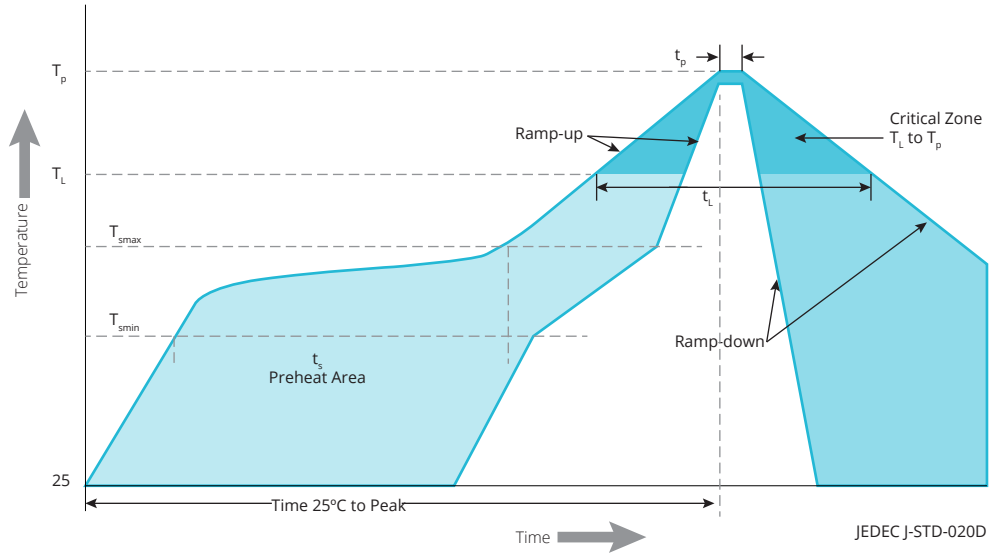

Figure 10. Visualization of the acceptable reflow temperature profile as specified in Table 8.

Table 8. Reflow profile characteristics for LUXEON 3535L Line.

PROFILE FEATURE	LEAD-FREE ASSEMBLY
Preheat Minimum Temperature ( $T_{smin}$ )	150°C
Preheat Maximum Temperature ( $T_{smax}$ )	200°C
Preheat Time ( $t_{smin}$ to $t_{smax}$ )	60 to 120 seconds
Ramp-Up Rate ( $T_L$ to $T_p$ )	3°C / second maximum
Liquidus Temperature ( $T_L$ )	217°C
Time Maintained Above Temperature $T_L$ ( $t_t$ )	60 to 150 seconds
Peak / Classification Temperature ( $T_p$ )	260°C
Time Within 5°C of Actual Temperature ( $t_p$ )	20 to 40 seconds
Ramp-Down Rate ( $T_p$ to $T_L$ )	6°C / second maximum
Time 25°C to Peak Temperature	8 minutes maximum

## JEDEC Moisture Sensitivity

Table 9. Moisture sensitivity levels for LUXEON 3535L Line.

LEVEL	FLOOR LIFE		SOAK REQUIREMENTS STANDARD	
	TIME	CONDITIONS	TIME	CONDITIONS
2	1 Year	≤30°C / 60% RH	168 Hours +5 / -0	85°C / 60% RH

# Solder Pad Design

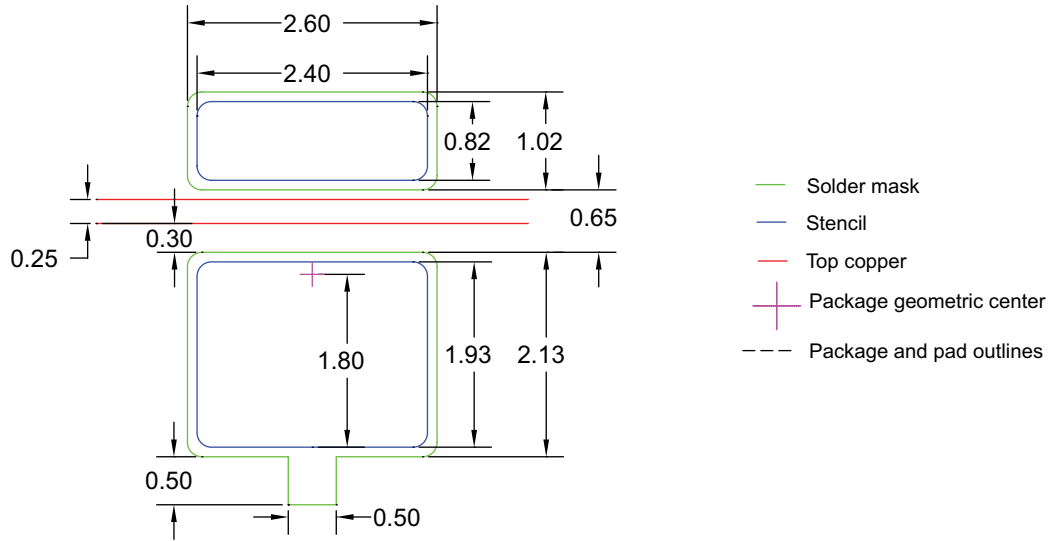

Figure 11. Recommended PCB solder pad layout for LUXEON 3535L Line.

- Notes for Figure 11:
1. Drawings are not to scale.
  2. All dimensions are in millimeters.

# Packaging Information

## Pocket Tape Dimensions

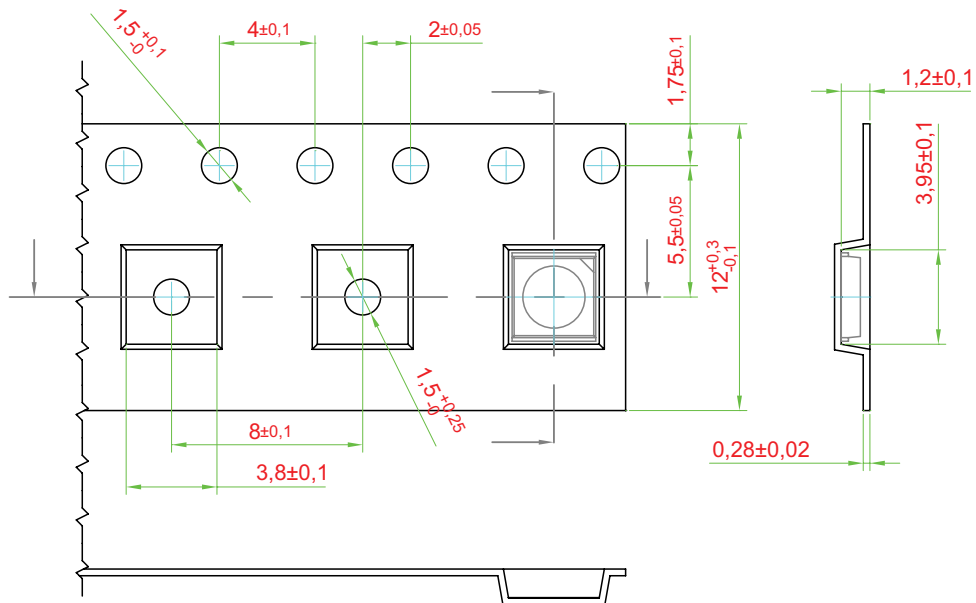

Figure 12. Pocket tape dimensions for LUXEON 3535L Line.

- Notes for Figure 12:
1. Drawings are not to scale.
  2. All dimensions are in millimeters.

# Reel Dimensions

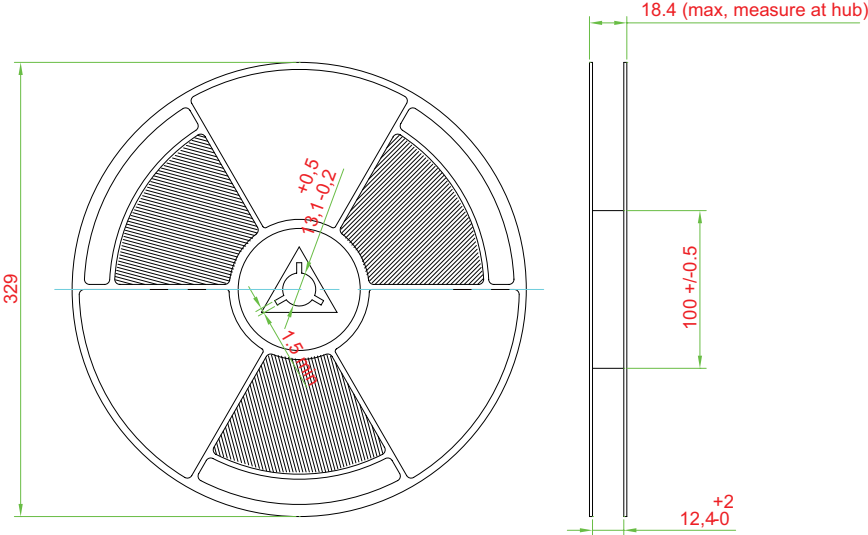

Figure 13. Reel dimensions for LUXEON 3535L Line.

- Notes for Figure 13:
- 1. Drawings are not to scale.
  - 2. All dimensions are in millimeters.



## About Lumileds

Lumileds is the global leader in light engine technology. The company develops, manufactures and distributes groundbreaking LEDs and automotive lighting products that shatter the status quo and help customers gain and maintain a competitive edge.

With a rich history of industry “firsts,” Lumileds is uniquely positioned to deliver lighting advancements well into the future by maintaining an unwavering focus on quality, innovation and reliability.

To learn more about our portfolio of light engines, visit [lumileds.com](http://lumileds.com).



---

©2016 Lumileds Holding B.V. All rights reserved.  
LUXEON is a registered trademark of the Lumileds Holding B.V.  
in the United States and other countries.

[lumileds.com](http://lumileds.com)

Neither Lumileds Holding B.V. nor its affiliates shall be liable for any kind of loss of data or any other damages, direct, indirect or consequential, resulting from the use of the provided information and data. Although Lumileds Holding B.V. and/or its affiliates have attempted to provide the most accurate information and data, the materials and services information and data are provided “as is,” and neither Lumileds Holding B.V. nor its affiliates warrants or guarantees the contents and correctness of the provided information and data. Lumileds Holding B.V. and its affiliates reserve the right to make changes without notice. You as user agree to this disclaimer and user agreement with the download or use of the provided materials, information and data.

DS203 LUXEON 3535L  
Product Datasheet 20161001