

N type Coaxial Connectors

N Series

■ Features

1. 50 ohms wide varieties standard connectors
2. Screw on locking
3. Applicable cable : RG cable, JIS cable
4. Applicable standard : MIL-C-39012/MIL STD 348-304

■ Functional diagram

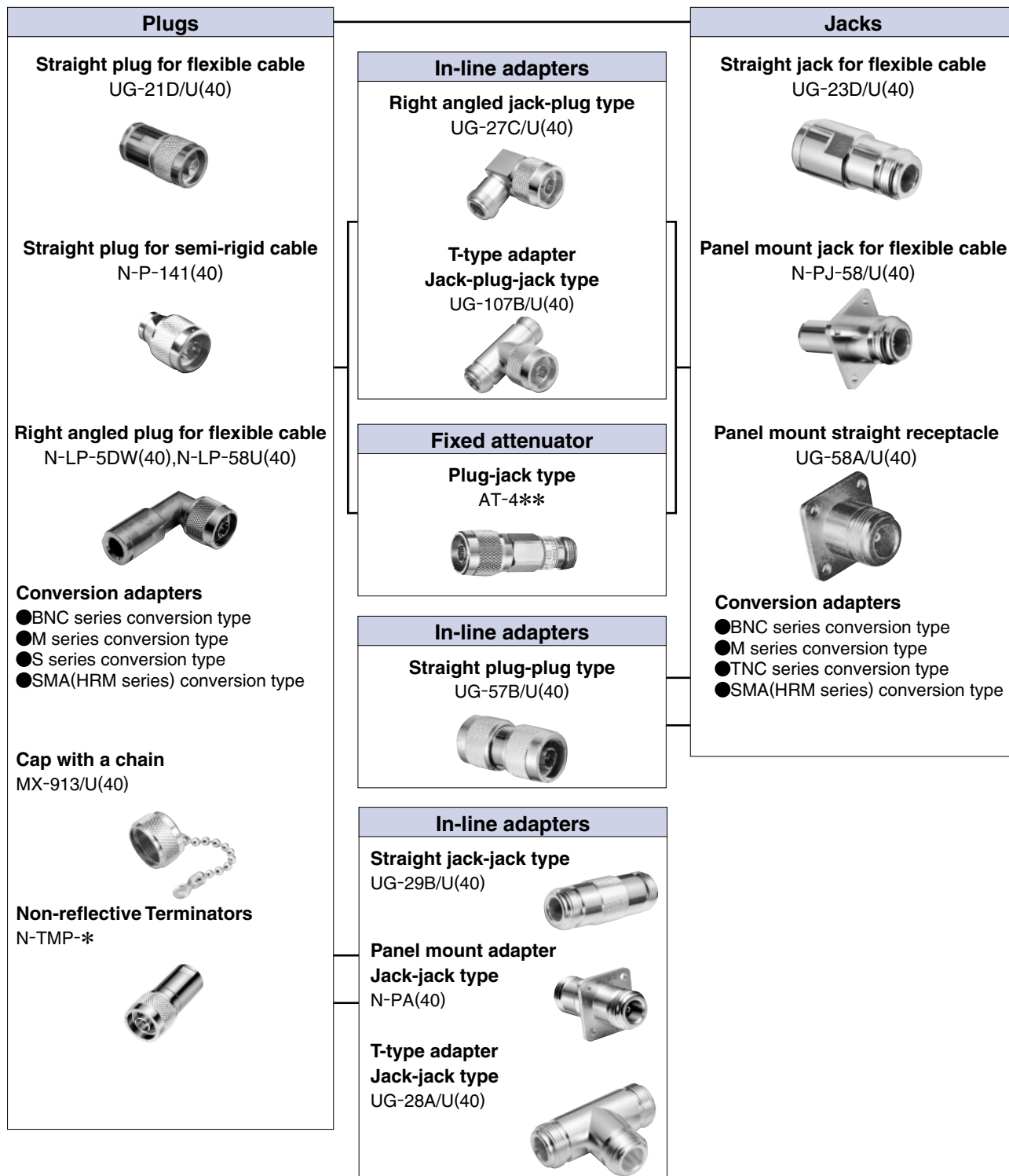

Product Specifications

Ratings	Nominal characteristic impedance Frequency range	50 ohms DC to 2 GHz	Operating temperature range Operating humidity	-30°C to +60°C 95%RH max.
---------	---	------------------------	---	------------------------------

Item	Specification	Conditions
1. Contact resistance	3 m Ω max.	100 mA max.
2. Insulation resistance	1000 M Ω min.	500 V DC
3. Withstanding voltage	No flashover or insulation breakdown.	1500 V AC / 1 minute
4. V.S.W.R.*	1.2 max.	Up to 2GHz
5. Durability (mating / un-mating, with corresponding plug)	10 m Ω max.	500 cycles
6. Vibration	No electrical discontinuity of 1μs min.	Frequency: 10 to 500 Hz, single amplitude of 0.75mm, acceleration of 98m/s ² , for 10 cycles in the direction of each of the 3 axis.
7. Shock	No damage, cracks or parts dislocation.	Acceleration of 490 m/s ² , 11ms duration, sine half-wave waveform, 3 cycles in each of 3 axes.
8. Humidity (Steady state)	No damage, cracks or parts dislocation.	96 hours at temperature of 40°C and humidity of 80% to 96%.
9. Temperature cycle	No damage, cracks or parts dislocation.	Temperature: -55°C→+25 to +65°C→+85°C→+5 to +35°C Time: 30min.→ 5min. →30min.→ 5min. 5 cycles
10. Salt spray	No excessive corrosion	5% salt water solution, 48 hours

*V.S.W.R. Measurement System

The above V.S.W.R. standard values were measured using the measurement connection as shown below.

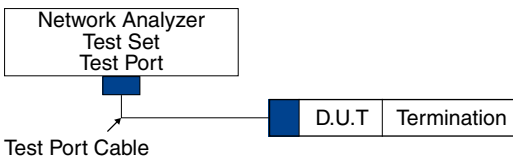

Note 1: Connectors with cable are measured with 10 cm of suitable cable attached at both ends.

Material

Part	Material	Finish	Remark
Shell	Brass	Silver plated/Nickel plated	——
Male contact	Brass	Silver plated/Gold plated	——
Female contact	Beryllium copper	Silver plated/Gold plated	——
Insulator	Tetrafluoride resin	——	Flame retardant
Packing	Silicone rubber	——	Flame retardant

Ordering information

●Standard

N - L P - 5DW

① ② ③ ④

① Series name : N	③ Connector type P : Plug J : Jack PJ : Panel jack R : Receptacle A : Adapter PA : Panel adapter
② Connector style Blank : Straight type L : L angle type T : T angle type	④ Applicable cable

●Product with MIL standard

UG - 21 D / U

① ② ③ ④

① High frequency coaxial connectors
② Product identification number
③ Improved sign

■Straight Plug

●Flexible cable type

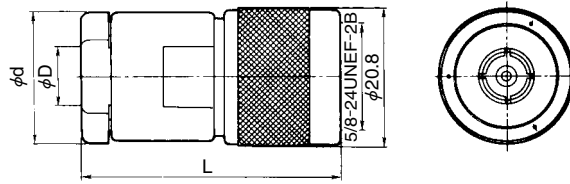

Unit : mm

Part No.	HRS No.	Packaging	Applicable cable	ϕD	ϕd	L
UG-21D/U(40)	301-0003-0 40	1	RG-8/U, RG-9/U	11.1	19.0	38.0
JUG-536/U(40)	301-0001-4 40		RG-58/U	5.4	19.0	38.0
N-P-3DV(40)	301-0078-9 40		3D-2V	6.3	12.7	35.0
N-P-5DV(40)	301-0120-3 40		5D-2V	8.6	18.0	45.5
N-P-5DW(40)	301-0199-3 40		5D-2W	9.3	18.0	46.0
N-P-5DFB(40)	301-0205-4 40		5D-FB	8.6	18.0	46.0
N-P-10DFB(40)	301-0206-7 40		10D-FB	14.5	23.0	55.0

●Semi rigid cable type

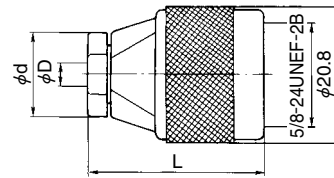

Unit : mm

Part No.	HRS No.	Packaging	Applicable cable	ϕD	ϕd	L
N-P-141(40)	301-0162-3 40	1	UT-141A	3.63	13	27.3
N-P-141-2(A)(40)	301-0262-8 40		UT-141A	3.63	5	25.7
N-P-250(A)(41)	301-0261-5 41		UT-250	6.5	14	34.9

■Right angle plug

●Flexible cable type

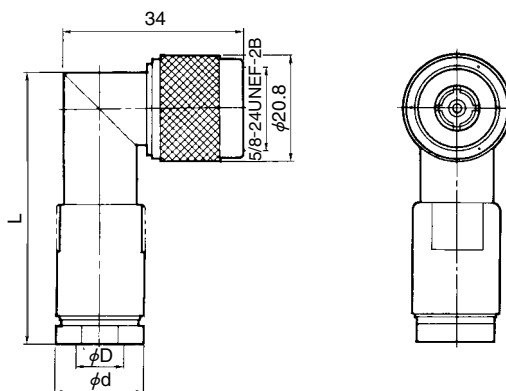

Unit : mm

Part No.	HRS No.	Packaging	Applicable cable	ϕD	ϕd	L	Remarks
N-LP-5DW(40)	301-0007-0 40	1	5D-2W	9.3	17.5	52.4	Nickel-plated except for center conductor
N-LP-58U(40)	301-0076-3 40		RG-58/U	5.3	15.5	44.0	—————

■ Straight jack

● Flexible cable type

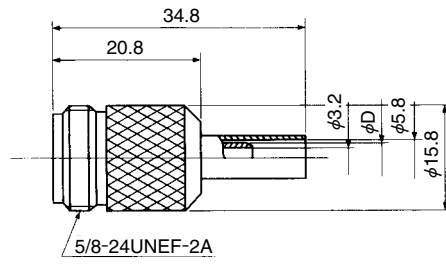

Unit : mm

Part No.	HRS No.	Packaging	Applicable cable	φD
N-J-3DV(40)	301-0180-5 40	1	3D-2V	5.1

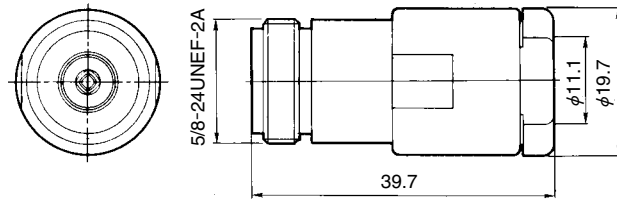

Part No.	HRS No.	Packaging	Applicable cable
UG-23D/U(40)	301-0008-3 40	1	RG-8/U, RG-9/U

■ Panel mount jack

● Flexible cable type

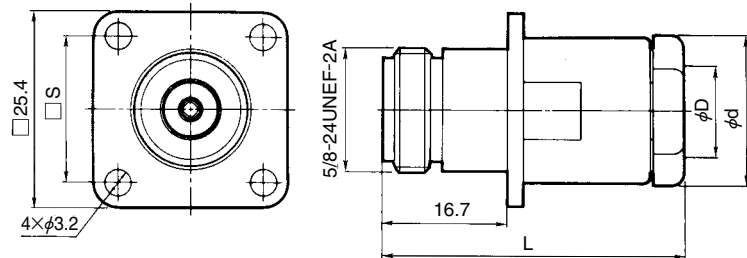

Unit : mm

Part No.	HRS No.	Packaging	Applicable cable	φD	φd	L	□S
UG-22D/U(40)	301-0010-5 40	1	RG-8/U, RG-9/U	11.1	19.0	39.7	18.24
N-PJ-58/U(40)	301-0011-8 40		RG-58/U	5.4	14.6	41.5	18.2

■ Receptacle

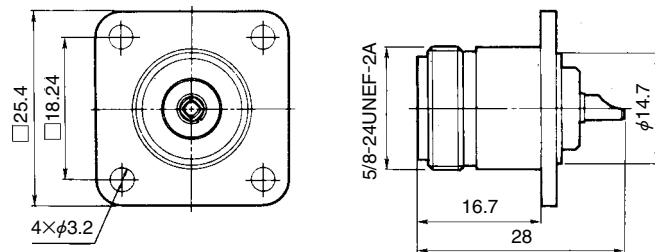

Part No.	HRS No.	Packaging
UG-58A/U(40)	301-0012-0 40	1

■ Straight plug(waterproof type)

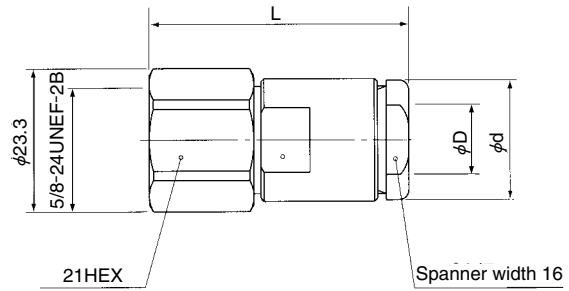

Unit : mm

Part No.	HRS No.	Packaging	Applicable cable	φD	φd	L
N-P-5DFXL(41)	301-0235-5 41	1	5D-FXL	8.6	18	47.2
N-P-8DGXC(40)	301-0228-0 40		8D-GXC	11.6	19.5	49.9

* IP67 compliant

■ Straight jack(waterproof type)

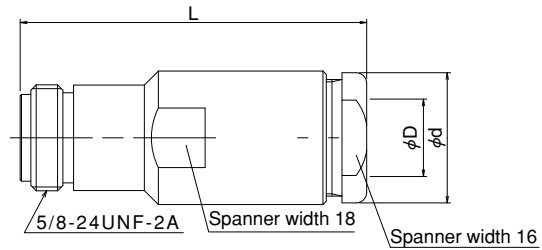

Unit : mm

Part No.	HRS No.	Packaging	Applicable cable	φD	φd	L
N-J-5DFXL(40)	301-0237-0 40	1	5D-FXL	8.6	18	49.1
N-J-8DGXC(40)	301-0229-2 40		8D-GXC	11.6	19.5	51.9

* IP67 compliant

■Adapter

●Straight adapter (jack-jack type)

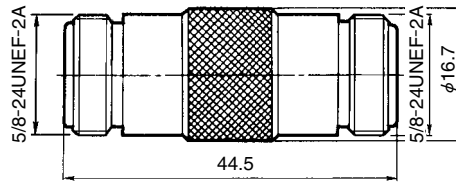

Part No.	HRS No.	Packaging
UG-29B/U(40)	301-0035-6 40	1

(Plug-plug type)

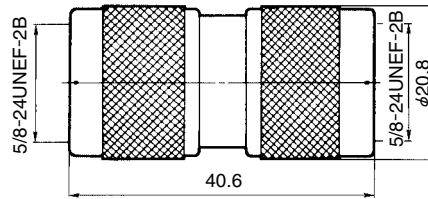

Part No.	HRS No.	Packaging
UG-57B/U(40)	301-0018-7 40	1

●Panel mount adaper (jack-jack type)

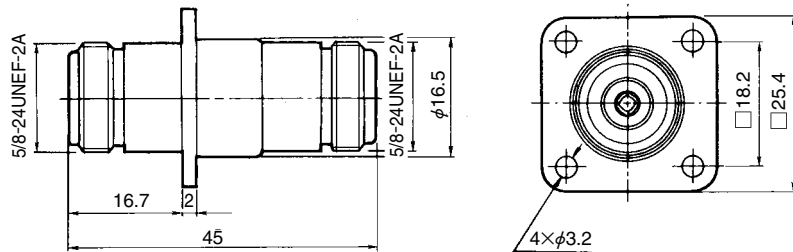

Part No.	HRS No.	Packaging
N-PA(40)	301-0036-9 40	1

●Right angle adapter (Plug-jack type)

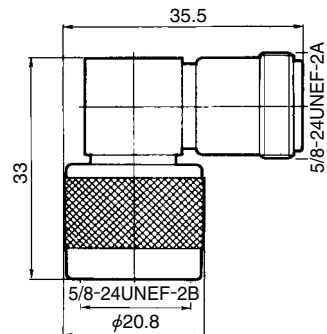

Part No.	HRS No.	Packaging
UG-27C/U(40)	301-0015-9 40	1

**T-shaped adapter
(Jack-jack-jack type)**

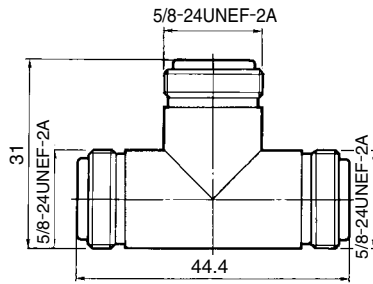

Part No.	HRS No.	Packaging
UG-28A/U(40)	301-0017-4 40	1

(Jack-plug-jack)

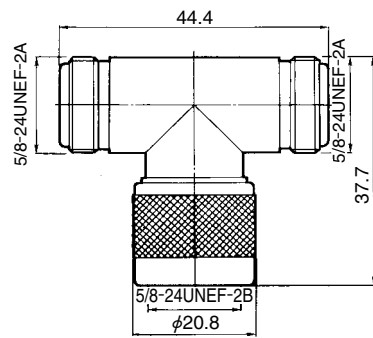

Part No.	HRS No.	Packaging
UG-107B/U(40)	301-0016-1 40	1

Conversion adapters

Mating portion 1		Mating portion 2		Part No.	HRS No.	Packaging
Series name	Mating portion	Series name	Mating portion			
N	Plug	BNC	Plug	NP-BNCP(40)	311-0050-7 40	1
			Jack	JUG-201A/U(40)	311-0007-8 40	
		M	Jack	NP-MJ(40)	311-0019-7 40	
			Jack	N.P-S.J(40)	311-0245-6 40	
		SMA (HRM)	Plug	HRM-555S(40)	311-0125-4 40	
			Jack	HRM-554S(40)	311-0123-9 40	
	Jack	BNC	Plug	UG-349/U(40)	311-0004-0 40	
			Jack	NJ-BNCJ(40)	311-0005-2 40	
				NJ-BNCJ-PA(40)	311-0014-3 40	
		M	Plug	NJ-MP(40)	311-0018-4 40	
			Jack	NJ-MJ(40)	311-0011-5 40	
		TNC	Plug	N.J-TNC.P(40)	311-0225-9 40	
		SMA (HRM)	Plug	HRM-553S	311-0121-3	
				HRM-557SV	311-0272-9	
Jack	HRM-552S		311-0119-1			
		HRM-556SV	311-0298-2			

**Cap
With a chain**

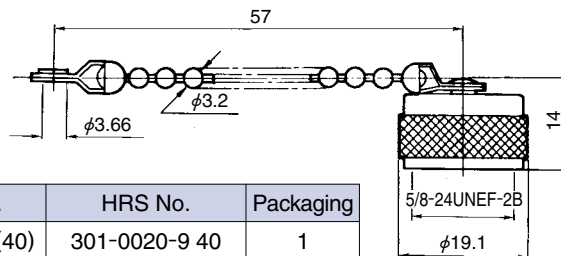

Part No.	HRS No.	Packaging
MX-913/U(40)	301-0020-9 40	1

◆ Cable assembly procedure

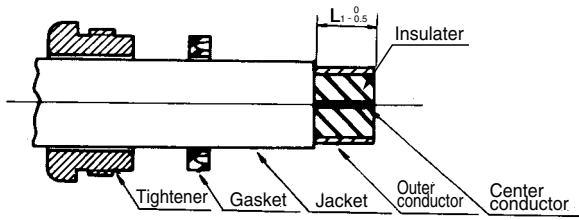

The cable ends are processed as shown in the drawing. For the dimensions L_1 , refer to Table 1, which shows dimensions arranged L by part number.

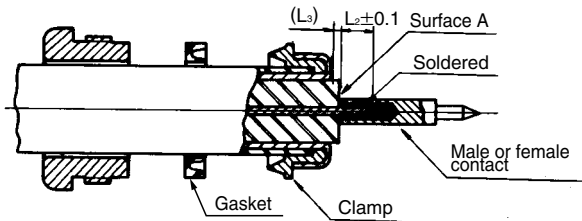

- (1) Insert clamp from tip of cable and fold outer conductor of cable back onto clamp. Using a knife, cut off excess outer conductor left at this time.
- (2) Cut off center conductor of cable at L_2 , from surface A of cable insulation. For dimensions of L_2 and L_3 , refer to Table 1. L_3 is a reference dimension.
- (3) Solder cable center conductor and male contact (or female contact). It is a good idea at this time to solder the contact preliminarily in advance.
(Note: There must be no gap between the contact and the cable insulation.)

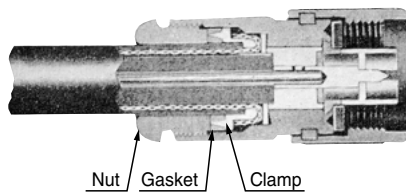

Insert cable and parts into shell and fit sharp end of clamp completely into V-shaped surface of gasket. Tighten tightening nut sufficiently.

■ Remarks

1. The cable dimensions L are based on the MIL and DSP standards. They may differ somewhat depending on the type of cable. In such cases, match the dimensions with the connectors.
2. Some clamps and gaskets does not have not V-shaped, but the assembling procedures are the same.

Table 1 Dimensions L arranged by part number

Unit : mm

Part No.	HRS No.	$L_{1-0.5}$	$L_{2+0.1}$	L_3
JUG-536/U(40)	301-0001-4 40	8.6	6	1
UG-21D/U(40)	301-0003-0 40	10.0	6	1
N-LP-5DW(40)	301-0007-0 40	11.5	4	3.5
UG-23D/U(40)	301-0008-3 40	8.5	5	1
UG-22D/U(40)	301-0010-5 40	8.5	5	1
N-PJ-58/U(40)	301-0011-8 40	7.4	3	3.2
N-LP-58U(40)	301-0076-3 40	9.2	4	3.6
N-P-3DV(40)	301-0078-9 40	12.3	6	4.8
N-P-5DV(40)	301-0120-3 40	11.1	6	1.5
N-P-5DW(40)	301-0199-3 40	12.0	6	1.5
N-P-5DFB(40)	301-0205-4 40	11.0	6	5
N-P-10DFB(40)	301-0206-7 40	11.0	6	5

■ Non-reflective Terminators (Coupling portion plug)

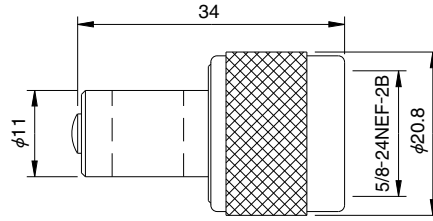
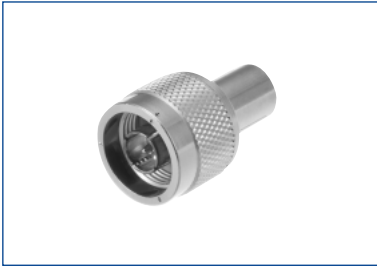

Part No.	HRS No.	Frequency range (GHz)	V.S.W.R.(Max)			Power (W)	Weight (g)	Packaging
			DC~4GHz	4~6GHz	6~8GHz			
N-TMP-1-1(50)	353-0137-5 50	DC~8	1.10	1.15	1.20	1	59	1

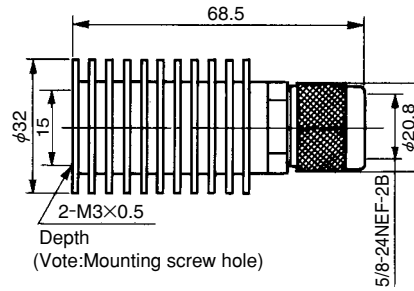

Part No.	HRS No.	Frequency range (GHz)	V.S.W.R.(Max)		Power (W)	Weight (g)	Packaging
			DC~2GHz	2~6GHz			
N-TMP-5(40)	353-0033-0 40	DC~6	1.15	1.20	5	113	1

Fixed Attenuators(plug-jack)

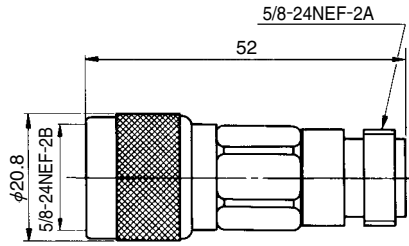

Part No.	HRS No.	Frequency range (GHz)	V.S.W.R.(Max)			Attenuation(dB)			Power (W)	Weight (g)	Packaging
			DC~2GHz	2~4GHz	4~13GHz	DC~2GHz	2~4GHz	4~13GHz			
AT-401(40)	354-0081-9 40	DC~13	1.15	1.20	1.25	1±0.3	1 ^{+0.5} _{-0.3}	1 ^{+0.6} _{-0.3}	2	77	1
AT-402(40)	354-0082-1 40					2±0.3	2 ^{+0.5} _{-0.3}	2 ^{+0.6} _{-0.3}			
AT-403(40)	354-0033-6 40					3±0.3	3 ^{+0.5} _{-0.3}	3 ^{+0.7} _{-0.3}			
AT-406(40)	354-0034-9 40					6±0.3	6 ^{+0.5} _{-0.3}	6 ^{+0.7} _{-0.3}			
AT-410(40)	354-0035-1 40					10±0.5	10 ^{+0.8} _{-0.5}	10 ^{+1.0} _{-0.5}			
AT-420(40)	354-0036-4 40					20±0.5	20 ^{+0.8} _{-0.5}	20 ^{+1.2} _{-0.7}			

Typical data

Non-reflective Terminations

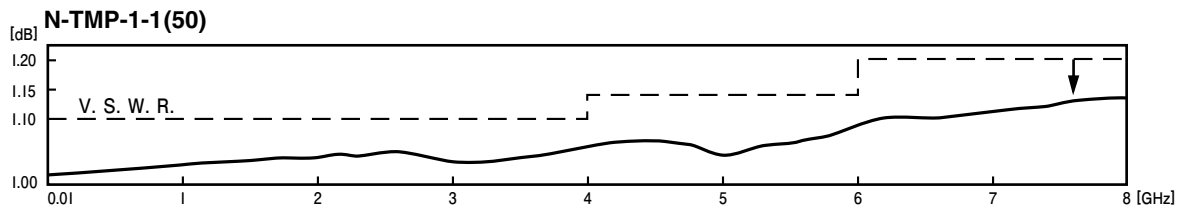

Fixed Attenuator

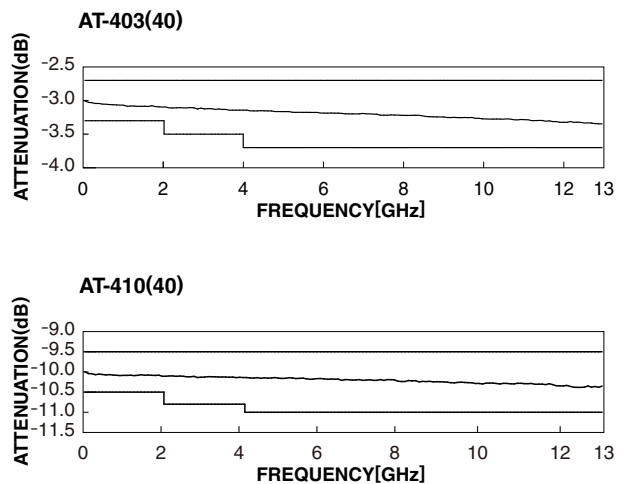
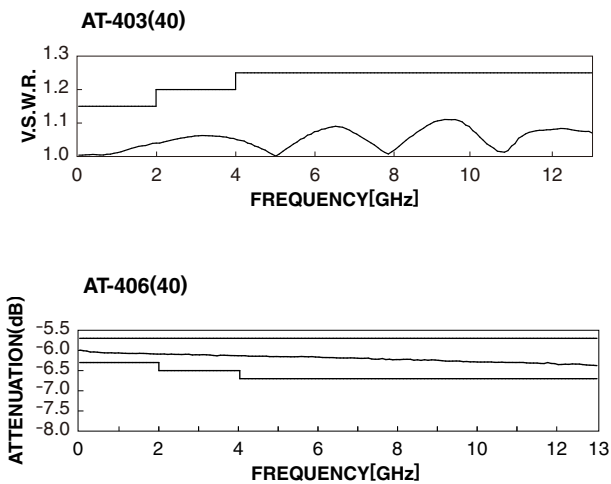

MEMO :

A series of horizontal dashed lines for taking notes.

USA:

HIROSE ELECTRIC (U.S.A.), INC. HEADQUARTERS
2688 Westhills Court, Simi Valley, CA 93065-6235
Phone : +1-805-522-7958
Fax : +1-805-522-3217
<http://www.hirose.com/us/>

USA:

HIROSE ELECTRIC (U.S.A.), INC. SAN JOSE OFFICE
3255 Scott Boulevard, Building 7, Suite 101
Santa Clara, CA 95054
Phone : +1-408-253-9640
Fax : +1-408-253-9641
<http://www.hirose.com/us/>

USA:

HIROSE ELECTRIC (U.S.A.), INC. CHICAGO OFFICE
580 Waters Edge Lane, Suite 205 Lombard IL
60148
Phone : +1-630-282-6706
Mail : inquiries@hirose.com
<http://www.hirose.com/us/>

USA:

HIROSE ELECTRIC (U.S.A.), INC. DETROIT OFFICE (AUTOMOTIVE)
37677 Professional Center Drive, Suite #100C
Livonia, MI 48154
Phone : +1-734-542-9963
Fax : +1-734-542-9964
<http://www.hirose.com/us/>

THE NETHERLANDS:

HIROSE ELECTRIC EUROPE B.V.
Hogehillweg #8 1101 CC Amsterdam Z-0
Phone : +31-20-6557460
Fax : +31-20-6557469
<http://www.hirose.com/eu/>

GERMANY:

HIROSE ELECTRIC EUROPE B.V. GERMAN BRANCH
Herzog-Carl-Strasse 4 D-73760 Ostfildern
(Scharnhäuser Park)
Phone : +49-711-4560-02-1
Fax : +49-711-4560-02-299
<http://www.hirose.com/eu/>

GERMANY:

HIROSE ELECTRIC EUROPE B.V. NUERNBERG OFFICE
Muggenhofer Str. 136 90429 Nuernberg
Phone : +49-911 32 68 89 63
Fax : +49-911 32 68 89 69
<http://www.hirose.com/eu/>

UNITED KINGDOM:

HIROSE ELECTRIC EUROPE BV (UK BRANCH)
4 Newton Court, Kelvin Drive, Knowlhill,
Milton Keynes, MK5 8NH
Phone : +44-1908 202050
Fax : +44-1908 202058
<http://www.hirose.com/eu/>

CHINA:

HIROSE ELECTRIC (SHANGHAI) CO., LTD.
1601, Henderson Metropolitan, NO.300, East Nanjing
Road, Huangpu District, Shanghai, China 200001
Phone : +86-21-6391-3355
Fax : +86-21-6391-3335
<http://www.hirose.com/cn/>

CHINA:

HIROSE ELECTRIC (SHANGHAI) CO.,LTD. BEIJING BRANCH
A1001, Ocean International Center, Building 56# East 4th
Ring Middle Road, ChaoYang District, Beijing, 100025
Phone : +86-10-5165-9332
Fax : +86-10-5908-1381
<http://www.hirose.com/cn/>

CHINA:

HIROSE ELECTRIC TECHNOLOGIES (SHENZHEN) CO., LTD.
Room 09-13, 19/F, Office Tower Shun Hing Square, Di Wang Commercial Centre,
5002 Shen Nan Dong Road, Shenzhen City, Guangdong Province, 518008
Phone : +86-755-8207-0851
Fax : +86-755-8207-0873
<http://www.hirose.com/cn/>

HONG KONG:

HIROSE ELECTRIC HONGKONG TRADING CO., LTD.
Room 1001, West Wing, Tsim Sha Tsui Centre, 66
Mody Road, Tsim Sha Tsui East, Kowloon, Hong Kong
Phone : +852-2803-5338
Fax : +852-2591-6560
<http://www.hirose.com/hk/>

TAIWAN:

HIROSE ELECTRIC TAIWAN CO., LTD.
103 8F, No.87, Zhengzhou Rd., Taipei
Phone : +886-2-2555-7377
Fax : +886-2-2555-7350
<http://www.hirose.com/cn/>

KOREA:

HIROSE KOREA CO., LTD.
1261-10, Jeoungwhang-Dong, Shihung-City,
Kyunggi-Do 429-450
Phone : +82-31-496-7000,7124
Fax : +82-31-496-7100
<http://www.hirose.co.kr/>

SINGAPORE:

HIROSE ELECTRIC SINGAPORE PTE. LTD.
10 Anson Road #26-1, International Plaza
079903, Singapore
Phone : +65-6324-6113
Fax : +65-6324-6123
<http://www.hirose.com/sg/>

INDIA:

HIROSE ELECTRIC SINGAPORE PTE. LTD. DELHI LIAISON OFFICE
Office NO.519, Regus-Green Boulevard, Level5, Tower C,
Sec62, Plot B-9A, Block B, Noida, 201301, Uttar Pradesh, India
Phone : +91-12-660-8018
Fax : +91-120-4804949
<http://www.hirose.com/sg/>

INDIA:

HIROSE ELECTRIC SINGAPORE PTE. LTD. BANGALORE LIAISON OFFICE
Unit No.03, Ground Floor, Explorer Building International Tech
Park Whitefield Road, Bangalore 560066 Karnataka, India
Phone : +91-80-4120 1907
Fax : +91-80-4120 9908
<http://www.hirose.com/sg/>

MALAYSIA:

HIROSE ELECTRIC SINGAPORE PTE. LTD. (REPRESENTATIVE OFFICE)
1-10-07, Suntech @ Penang Cybercity (1164),Lintang
Mayang Pasir 3,11950, Bayan Baru, Penang, Malaysia.
Phone : +604-619-2564
Fax : +604-619-2574
<http://www.hirose.com/sg/>



HIROSE ELECTRIC CO.,LTD.

2-6-3,Nakagawa Chuoh,Tsuzuki-Ku,Yokohama-Shi 224-8540,JAPAN
TEL: +81-45-620-3526 Fax: +81-45-591-3726
<http://www.hirose.com>
<http://www.hirose-connectors.com>

Mouser Electronics

Authorized Distributor

Click to View Pricing, Inventory, Delivery & Lifecycle Information:

[Hirose Electric:](#)

[N-P-141\(42\)](#) [N-P-250\(A\)\(41\)](#) [NP-HRMJ-PA-1\(40\)](#) [N-P-5DFB\(40\)](#) [N-P-5DV\(40\)](#) [N-P-5DFXL\(41\)](#) [N-P-1.5DQS\(40\)](#)
[N-P-2.5DQS\(40\)](#) [N-PA-JP-1\(40\)](#) [NP-HRMJ-PA-5\(40\)](#) [N-PJ-SF085-1](#) [N-P-8DGXC\(40\)](#) [N-P-3DV\(41\)](#) [N-PJ-1.5DW-](#)
[1\(40\)](#) [N-TMP-3-2\(40\)](#) [N-P-1.5DV](#) [N-P-141\(40\)](#) [N-P-2.5DV\(40\)](#) [N-PA\(42\)](#) [N-PJ-2.5DFXL\(40\)](#) [N-P-5DW\(41\)](#) [N-P-141-](#)
[2\(A\)\(40\)](#) [N-PJ-085-1](#) [N-PA\(40\)](#) [N-TMP-1\(40\)](#) [N-PJ-58/U\(40\)](#) [N-PJ-1.5DQS-1\(40\)](#) [N-P-250-1\(41\)](#) [NP-BNCP\(40\)](#) [N-](#)
[P-5DW\(40\)](#) [N-P-3DV\(40\)](#) [N-P-8DV\(40\)](#) [N-PJ-250\(40\)](#) [N-TMP-1-1\(50\)](#) [N-P-1.5DW](#) [N-P-10DFB\(40\)](#)