

Features

- Efficiency up to 95%, no Need for Heatsinks!
- Industry Standard Pin-Out
- 1.5A Start-Up Overload Capacity
- Non-Isolated Regulator with very low Standby Current
- Wide Input Range (7V ~ 42V)
- Short Circuit Protection
- Fixed Switching Frequency (350kHz), Shielded Magnetics

Description

The R-78T is a switching regulator with a wide input voltage range and a low profile SMD package. Three output voltages are available as standard: 3.3V, 5V and 12V. Due to the 1.5A start-up overload capability, the R-78T can be used to replace 1A or 1.5A regulators in many applications. These modules come with three different styles to be pin-compatible with existing solutions, but at a lower cost.

Selection Guide

Part Number SIP3	Input Range (V)	Output Voltage (V)	Output Current (A)	Efficiency	
				Min. Vin (%)	Max. Vin (%)
R-78T3.3-1.0*	7 – 42	3.3	1.0	88	79
R-78T5.0-1.0*	8 – 42	5.0	1.0	92	85
R-78T12-1.0*	15 – 42	12	1.0	95	92

*add suffix /FC, /AC or /AL for required pinning option

* add suffix -R for tape&reel packing e.g. R-78T3.3-1.0/FC-R.

-Tray for Tray packaging, e.g. R-78T5.0-1.0/AC-Tray For more details see Application Notes.

Specifications (typical at 25°C, 10% minimum load, unless otherwise specified)

Input Voltage Range	3.3V 5V 12V	7-42VDC 8-42VDC 15-42VDC
No Load Input Current		1mA typ.
Input Filter		C Filter
Voltage Accuracy		±2% typ. / ±3% max.
Line Regulation	(LL to HL at Full Load)	±0.2% typ.
Load Regulation	(10-100%)	±0.4% typ.
Minimum Load		10%
Ripple & Noise (20MHz Limited)		50mVp-p typ. / 100mVp-p max.
Transient Response 50mA/uS	100% - 50% Load	±250mV max.
Operating Frequency		350KHz typ.
Current Limit		1.5A / 10sec max.
Short Circuit Protection		Current limited to 3.5A typ.
Operating Temperature		-40°C to 85°C
Storage Temperature		-55°C to 125°C
Humidity		5% to 95% RH max.
Dimension	suffix /AC or /AL suffix /FC	23 x 27.2 x 10mm 23 x 29.4 x 8mm
Weight		4.5g typ.
Cooling Method		Free Air Convection
MTBF (25°C)	MIL-HDBK-217F	367 x 10 ³ hours

Standard Application Circuit

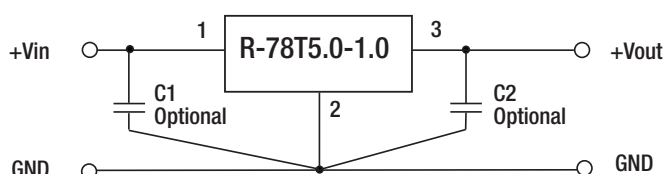

INNOLINE DC/DC-Converter

with 3 year Warranty

RECOM

1.0 AMP SMD Single Output

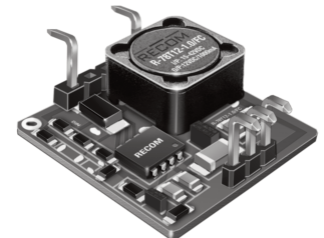

R-78T-1.0

Derating-Graph (Ambient Temperature)

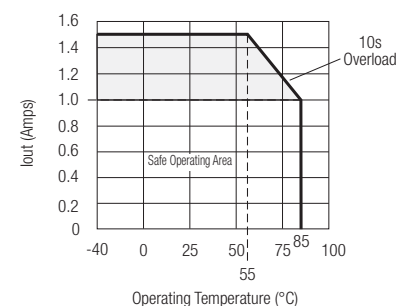

Refer to Application Notes

Typical Characteristics

Efficiency

R-78T3.3-1.0

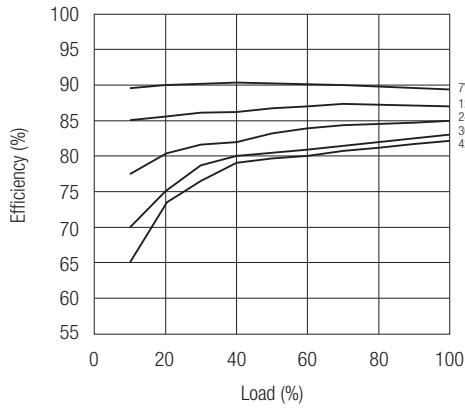

Ripple

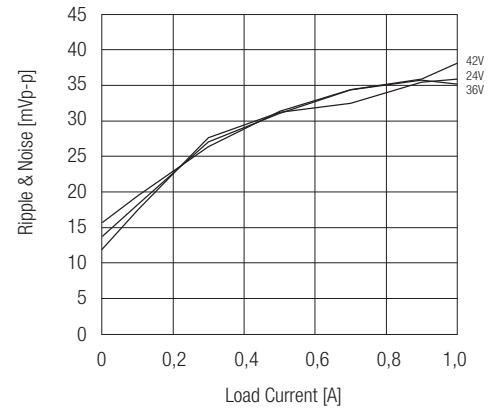

R-78T5.0-1.0

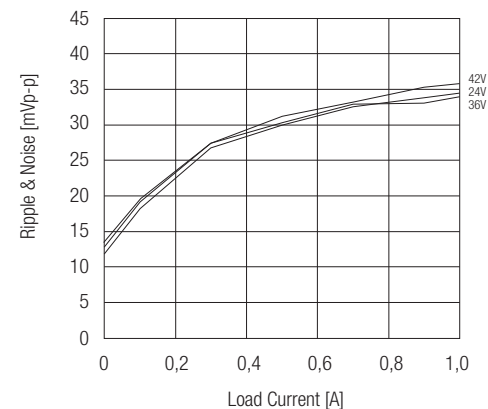
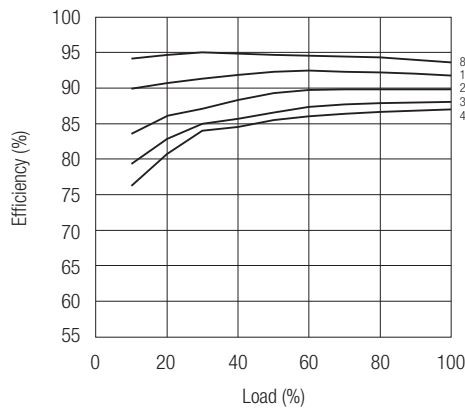

R-78T12-1.0

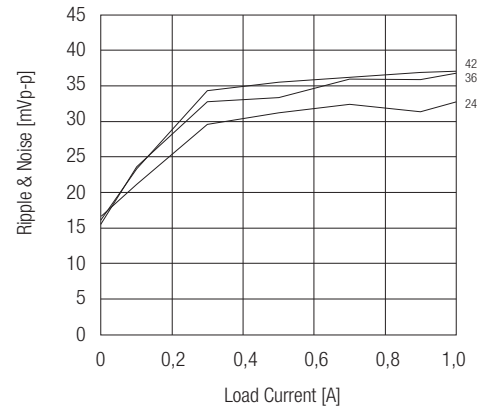
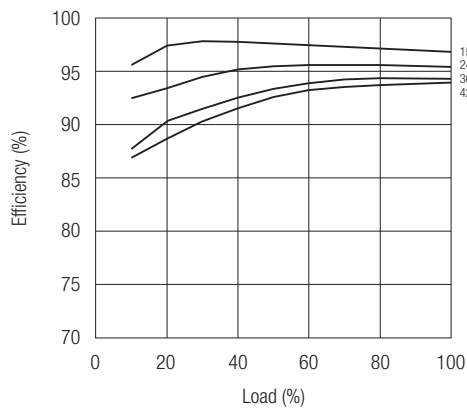

Package Style and Pinning (mm)

R-78Txx-1.0/AC

Recommended Footprint

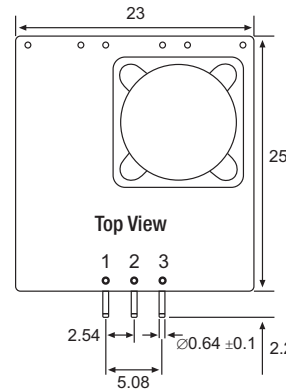
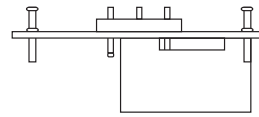
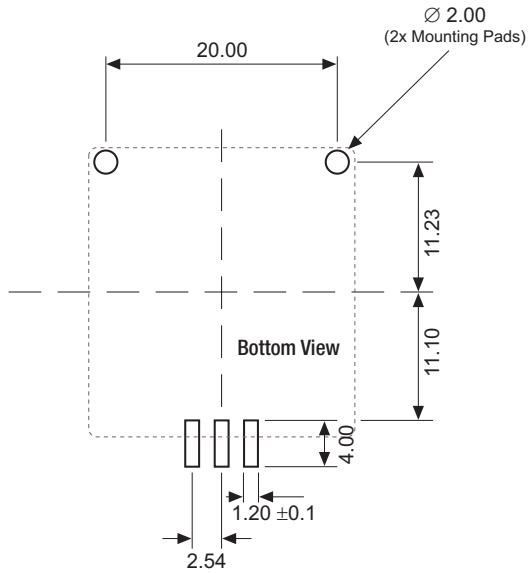

Pin Connections

Pin #	Connection
1	+Vin
2	GND
3	+Vout

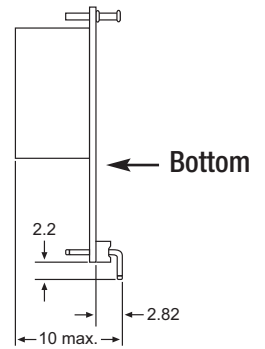

Tolerance ± 0.5 mm unless otherwise specified

R-78Txx-1.0/AL

Recommended Footprint

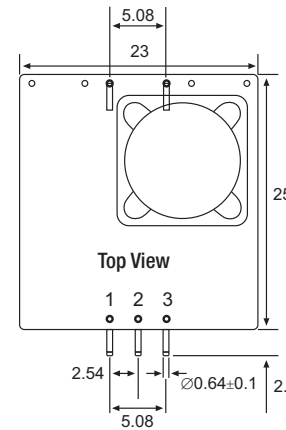
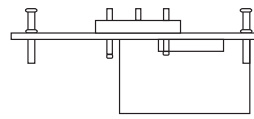
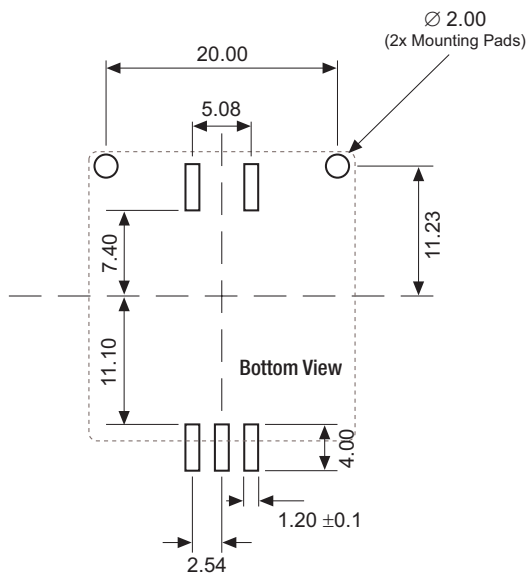

Pin Connections

Pin #	Connection
1	+Vin
2	GND
3	+Vout

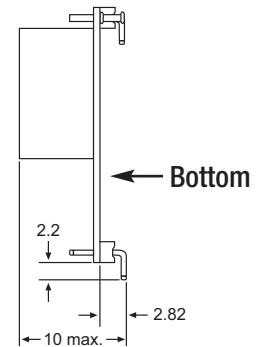

Tolerance ± 0.5 mm unless otherwise specified

Package Style and Pinning (mm)

R-78Txx-1.0/FC

Recommended Footprint

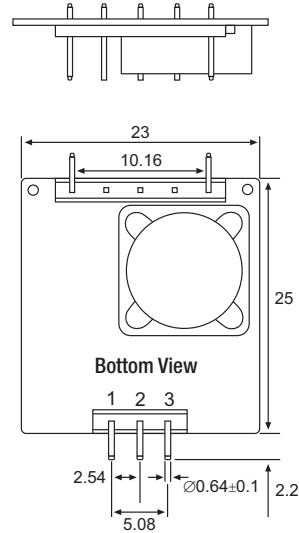
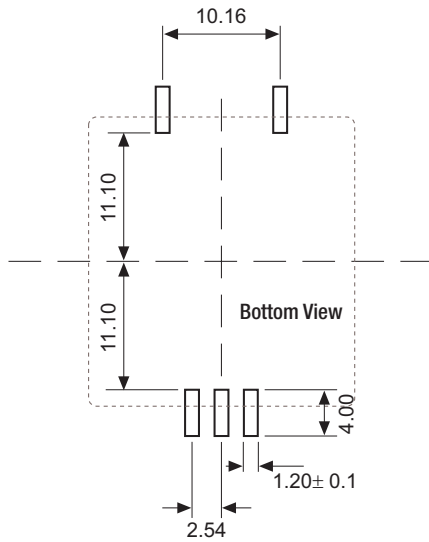

Pin Connections	
Pin #	
1	+Vin
2	GND
3	+Vout

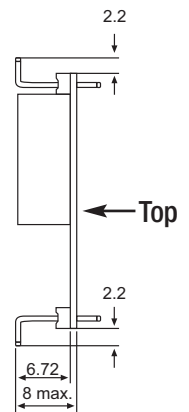

Tolerance $\pm 0.5\text{mm}$ unless otherwise specified