

Features

Regulated Converters

- 4:1 Wide Input Range
- 3kVAC Reinforced Insulation for 110Vin
2.25kVDC Basic Insulation for 24Vin & 48Vin
- Efficiency up to 91%
- No Minimum Load Required
- UL60950-1 Certified
- EN50155, IEC/EN60950-1 Pending



RP240H-RW

**240 Watt
Half Brick
Single Output**



Description

The half-brick RP240H series DC/DC converters are designed for railway rolling stock and high voltage battery applications. Each series has three 4:1 input voltage range options to cover all input voltages from 9VDC up to 160VDC with isolated and regulated 5V to 48VDC outputs. The converters have high efficiencies and metal baseplates to permit a wide operating temperature range from -40°C to +85°C (when mounted on a suitable heatsink). The case is fitted with threaded inserts to allow secure mounting to the PCB or bulkhead for use in high shock and vibration environments. The converters are EN50155, UL60950 and IEC/EN60950 certified. The RP240H-RW series have a three year warranty.

Selection Guide

Part Number	Input Voltage Range [VDC]	Output Voltage [VDC]	Output Current [mA]	Input ⁽¹⁾ Current [mA]	Output Power [W]	Efficiency ⁽¹⁾ typ. [%]	Max. Capacitive Load [µF]
RP240H-2405SRW	9-36	5	36000	8333	180	90	72000
RP240H-2412SRW	9-36	12	15000	8427	180	89	12500
RP240H-2415SRW	9-36	15	12000	8333	180	90	8000
RP240H-2424SRW	9-36	24	7500	8333	180	90	3100
RP240H-2448SRW	9-36	48	3700	8314	177.5	89	770
RP240H-4805SRW	16.5-75	5	40000	4578	200	91	80000
RP240H-4812SRW	16.5-75	12	18000	5000	216	90	15000
RP240H-4815SRW	16.5-75	15	14000	4807	210	91	9000
RP240H-4824SRW	16.5-75	24	9000	5000	216	90	3700
RP240H-4848SRW	16.5-75	48	4500	5000	216	90	930
RP240H-11005SRW	43-160	5	44000	2247	220	89	88000
RP240H-11012SRW	43-160	12	20000	2451	240	89	16600
RP240H-11015SRW	43-160	15	16000	2424	240	90	10600
RP240H-11024SRW	43-160	24	10000	2697	240	89	4100
RP240H-11048SRW	43-160	48	5000	2697	240	89	1000



EN50155 Pending
IEC/EN60950-1 Pending
UL60950-1 Certified

Notes:

Note1: Efficiency is tested by nominal Vin, full load and at 25°C.

Model Numbering

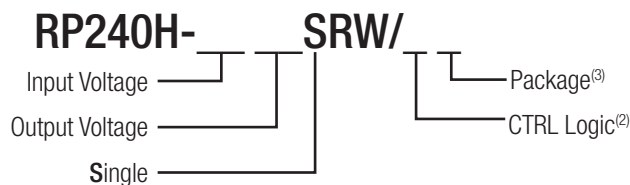

Ordering Examples

- RP240H-2405SRW/N = 24V Input, 5V Output, Single, Neg. CTRL function
- RP240H-11012SRW/P = 110V Input, 12V Output, Single, Pos. CTRL function
- RP240H-2405SRW/N-HC = 24V Input, 5V Output, Single, Neg. CTRL function with premounted Heat-sink

Notes:

- Note2: standard part is with suffix "P" for positive logic (1=ON, 0=OFF) or add suffix "N" instead for negative logic (0=ON, 1=OFF)
- Note3: add suffix "-HC" for premounted Heat-sink (compatible with all other suffixes)

Specifications measured @ $t_a = 25^\circ\text{C}$, resistive load, nominal V_{in} and rated I_{out} unless otherwise noted

BASIC CHARACTERISTICS					
Parameter	Condition		Min.	Typ.	Max.
Internal Input Filter					Pi-Type
Input Voltage Range	nom $V_{in} = 24\text{V}$ nom $V_{in} = 48\text{V}$ nom $V_{in} = 110\text{V}$		9VDC 16.5VDC 43VDC	24VDC 48VDC 110VDC	36VDC 75VDC 160VDC
Input Surge Voltage	$V_{in} = 24\text{V}$, 1s max. $V_{in} = 48\text{V}$, 1s max. $V_{in} = 110\text{V}$, 1s max.				50VDC 100VDC 185VDC
Quiescent Current	$V_{in} = 24\text{V}$ $V_{in} = 48\text{V}$ $V_{in} = 110\text{V}$		30mA 20mA 10mA		45mA 25mA 15mA
Start-up time	constant resistive load	Power up Remote ON/OFF		75ms 75ms	
Internal Operating Frequency			225kHz	250kHz	275kHz
Minimum Load			0%		
Ripple and Noise	Measured by 20MHz BW with a $1\mu\text{F}/25\text{V}$ X7R MLCC & a $22\mu\text{F}/25\text{V}$ POS Cap with a $1\mu\text{F}/25\text{V}$ X7R MLCC & a $22\mu\text{F}/25\text{V}$ POS Cap with a $4.7\mu\text{F}/50\text{V}$ X7R MLCC with a $2.2\mu\text{F}/100\text{V}$ X7R MLCC	5 Vout 12, 15Vout 24Vout 48Vout		75mVp-p 100mVp-p 200mVp-p 300mVp-p	
Under Voltage Lockout (UVLO)	$V_{in} = 24\text{V}$	DC-DC ON DC-DC OFF	7.3VDC		9VDC 8.1VDC
	$V_{in} = 48\text{V}$	DC-DC ON DC-DC OFF	15.5VDC		18VDC 16.3VDC
	$V_{in} = 110\text{V}$	DC-DC ON DC-DC OFF	33.0VDC		43VDC 36.0VDC
ON/OFF Control	Positive Logic	DC-DC ON DC-DC OFF		Open or $3.0\text{V} < V_r < 12\text{V}$ Short or $0\text{V} < V_r < 1.2\text{V}$	
	Negative Logic	DC-DC ON DC-DC OFF		Short or $0\text{V} < V_r < 1.2\text{V}$ Open or $3.0\text{V} < V_r < 12\text{V}$	
Input Current of CTRL pin			-0.5mA		1mA
Standby Current				3mA	
Output Trim			-20%		+10%
Remote Sense	% of set Vout				10%

RP240H-2405SRW

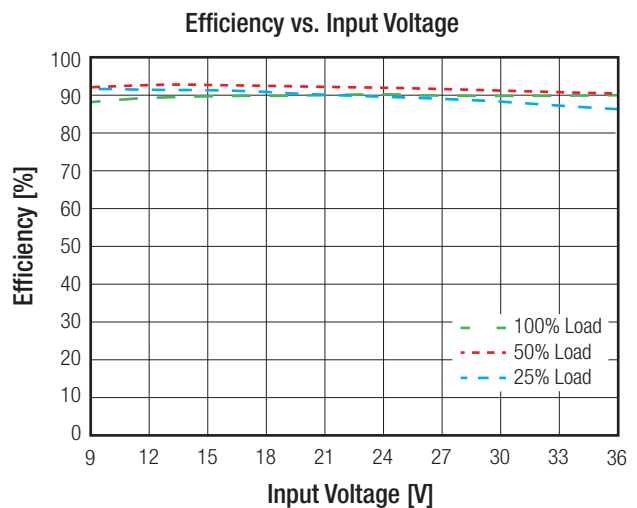
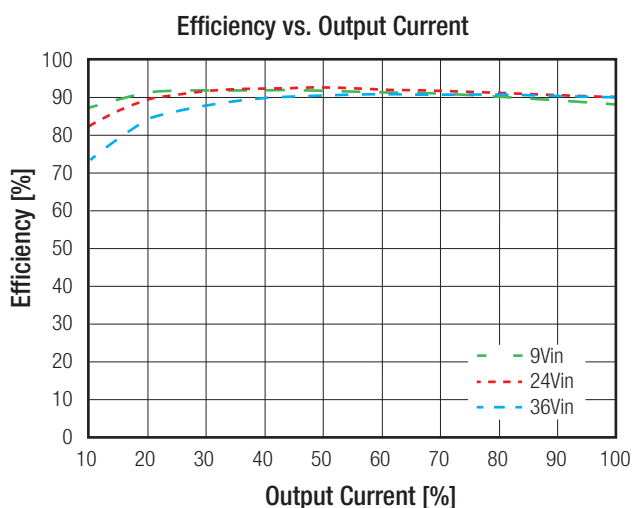

continued on next page

Specifications measured @ $t_a = 25^\circ\text{C}$, resistive load, nominal V_{in} and rated I_{out} unless otherwise noted

RP240H-2405SRW

Power Dissipation vs. Output Current

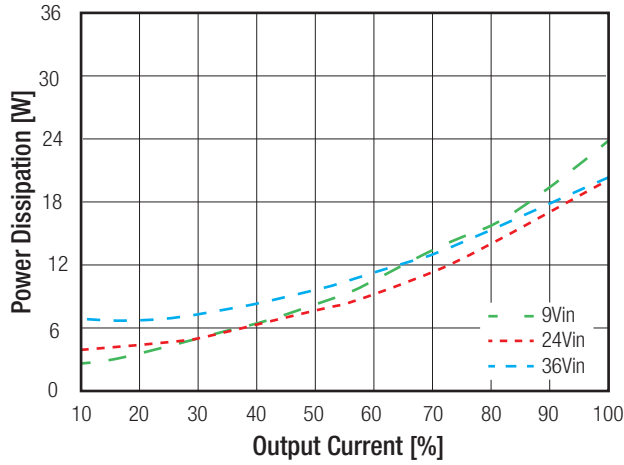

Typical Output Ripple and Noise/full load

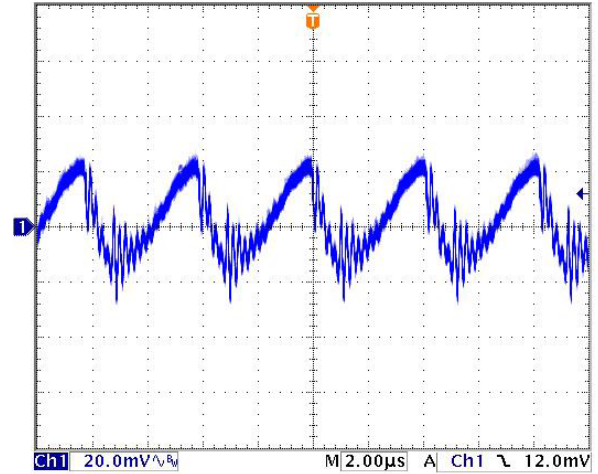

ON/OFF Control Start up Rise Characteristic

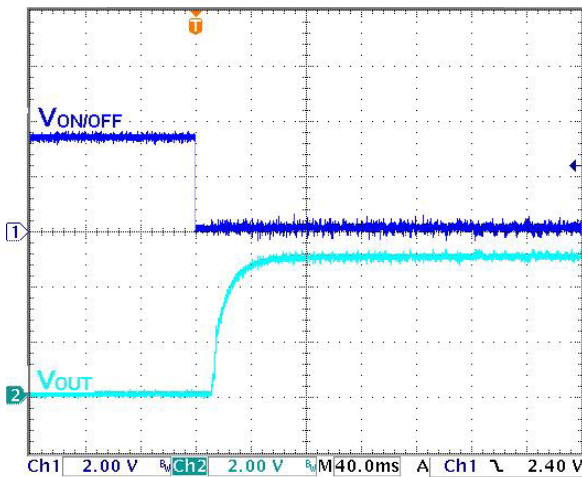

Power up Start-up Rise Characteristic

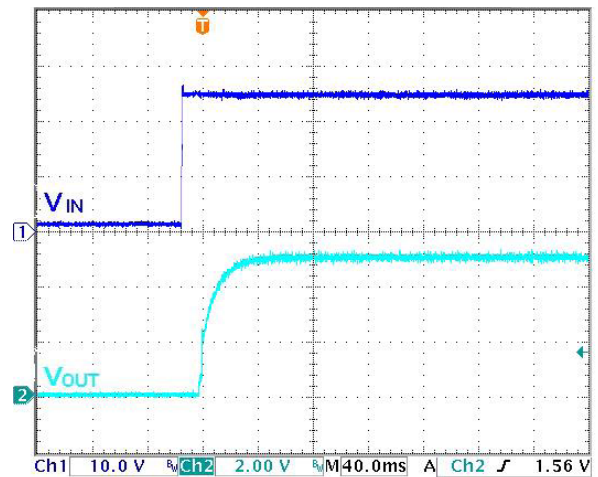

RP240H-4805SRW

Efficiency vs. Output Current

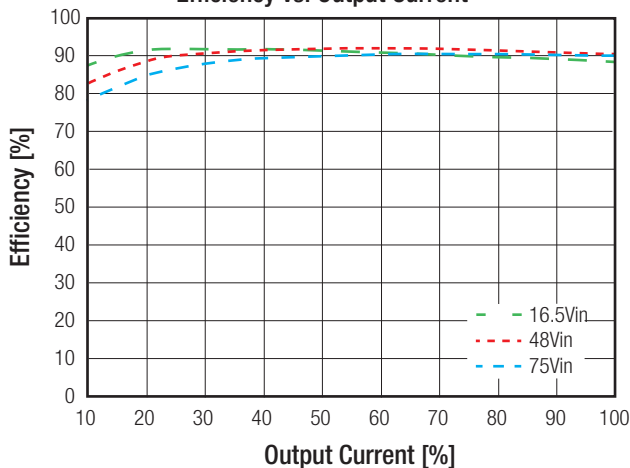

Efficiency vs. Input Voltage

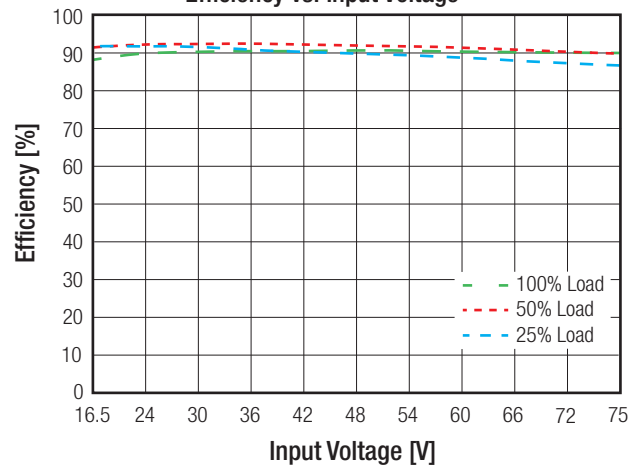

continued on next page

Specifications measured @ $t_a = 25^\circ\text{C}$, resistive load, nominal V_{in} and rated I_{out} unless otherwise noted

RP240H-4805SRW

Power Dissipation vs. Output Current

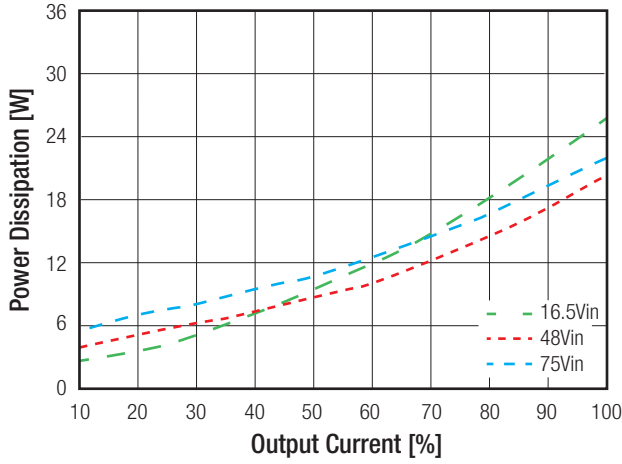

Typical Output Ripple and Noise/full load

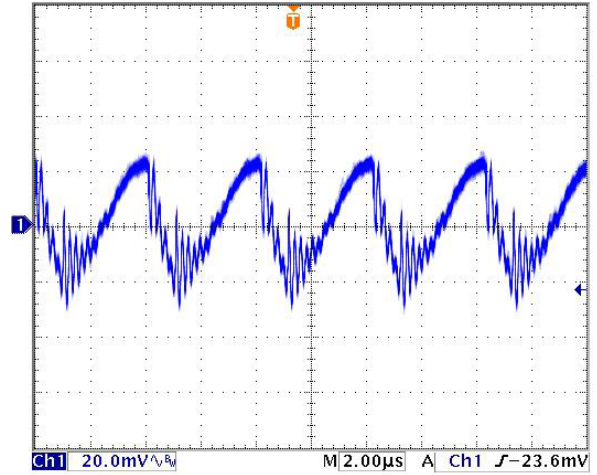

ON/OFF Control Start up Rise Characteristic

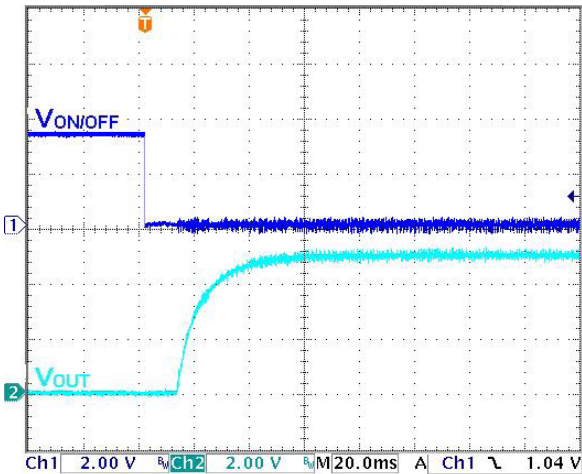

Power up Start-up Rise Characteristic

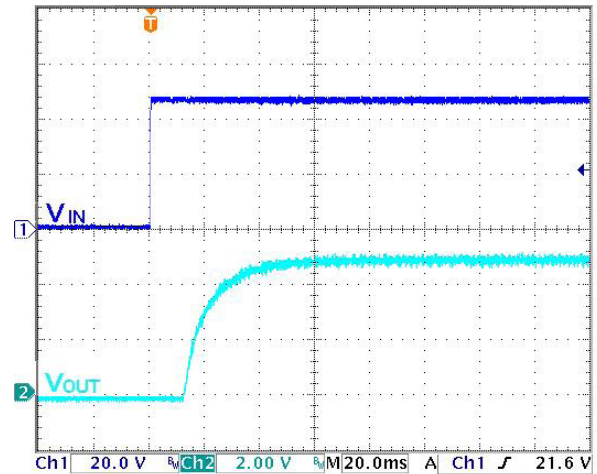

RP240H-11005SRW

Efficiency vs. Output Current

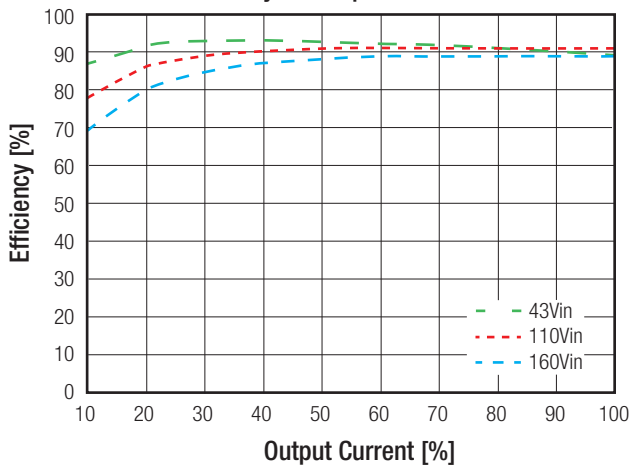

Efficiency vs. Input Voltage

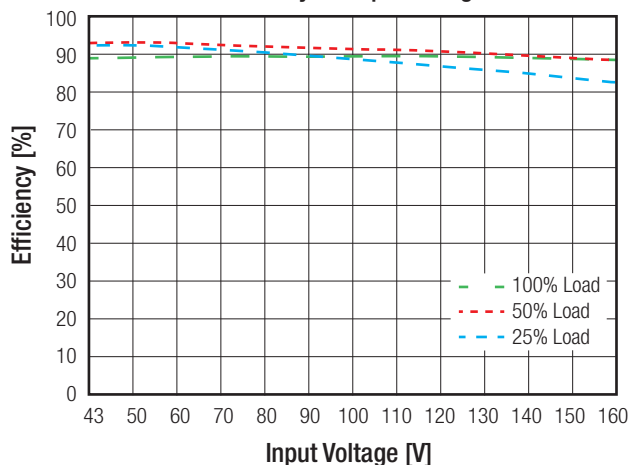

continued on next page

Specifications measured @ $t_a = 25^\circ\text{C}$, resistive load, nominal V_{in} and rated I_{out} unless otherwise noted

RP240H-11005SRW

Power Dissipation vs. Output Current

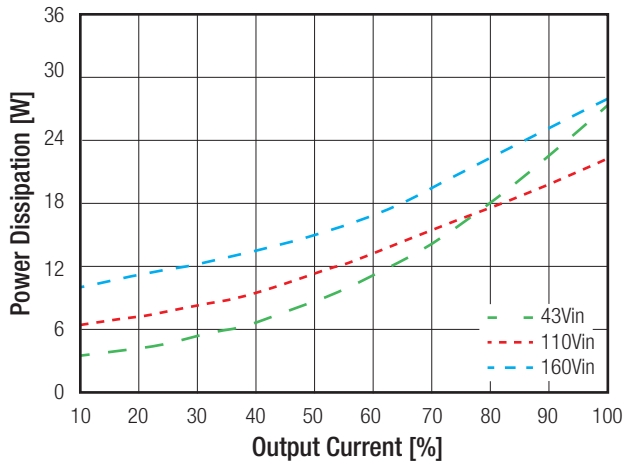

Typical Output Ripple and Noise/full load

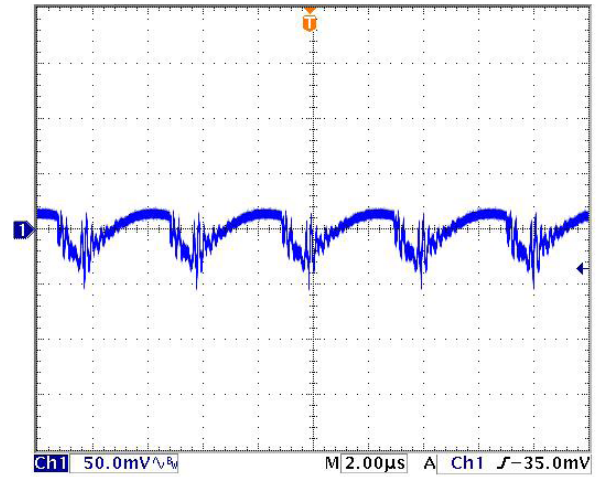

ON/OFF Control Start up Rise Characteristic

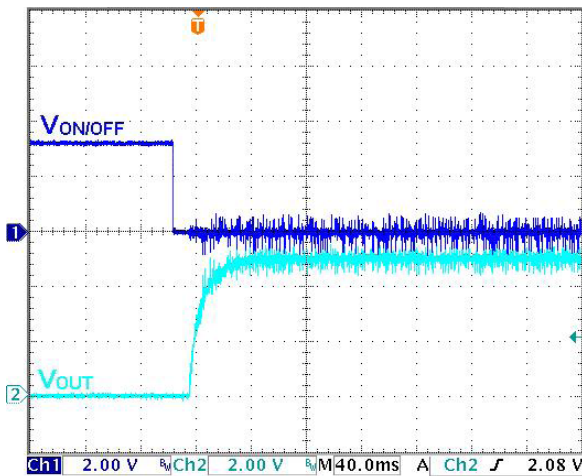

Power up Start-up Rise Characteristic

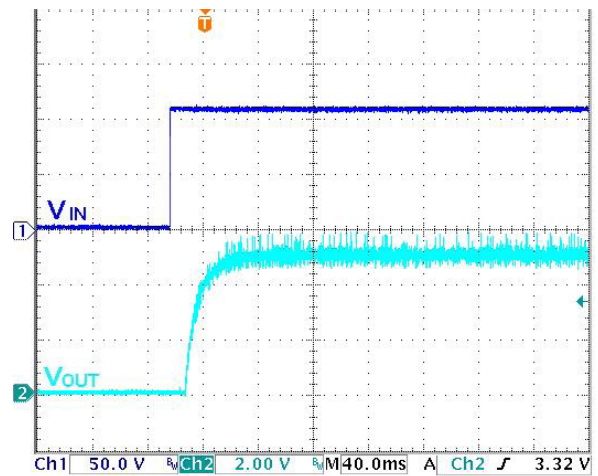

OUTPUT TRIM

Output Voltage Trimming

RP240H-RW converters offer the feature of trimming the output voltage over a certain range around the nominal value by using external trim resistors. The values for trim resistors shown in trim tables below are according to standard E96 values; therefore, the specified voltage may slightly vary; they also can be calculated with below shown equation.

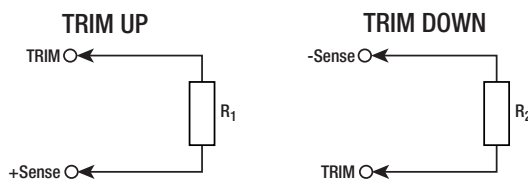

continued on next page

Specifications (measured @ ta= 25°C, nominal input voltage, full load and after warm-up)

OUTPUT TRIM

Trim Calculation

$$R_1 = \left[\frac{100 \cdot V_{out} + \Delta V_{out} \cdot V_{out}}{1.225 \cdot \Delta V_{out}} - \frac{(100 + 2 \Delta V_{out})}{\Delta V_{out}} \right] k\Omega$$

$$R_2 = \left[\frac{100}{\Delta V_{out}} - 2 \right] k\Omega$$

Vout = Output Voltage
 ΔV_{out} = Output Voltage Trim in %
 R1 = trim up resistor
 R2 = trim down resistor

Practical Example:

Trim Up:

Vout = 5V, ΔV_{out} = 10% (5.5V)

$$R_1 = \left[\frac{100 \cdot V_{out} + \Delta V_{out} \cdot V_{out}}{1.225 \cdot \Delta V_{out}} - \frac{(100 + 2 \Delta V_{out})}{\Delta V_{out}} \right] k\Omega = \frac{100 \cdot 5 + 10 \cdot 5}{1.225 \cdot 10} - \frac{100 + 2 \cdot 10}{10} = 44.89 - 12 = 33.2 k\Omega$$

Trim down:

Vout = 5V, ΔV_{out} = -10% (4.5V)

$$R_2 = \left[\frac{100}{\Delta V_{out}} - 2 \right] k\Omega = \frac{100}{10} - 2 = 8.06 k\Omega$$

RP240H-xx05SRW

Trim up	1	2	3	4	5	6	7	8	9	10	%
Vout =	5.05	5.10	5.15	5.20	5.25	5.30	5.35	5.4	5.45	5.50	Volts
R ₁ =	309	158	105	78.7	63.4	53.6	46.4	40.2	36.5	33.2	KOhms

RP240H-xx12SRW

Trim up	1	2	3	4	5	6	7	8	9	10	%
Vout =	12.12	12.24	12.36	12.48	12.60	12.72	12.84	12.96	13.08	13.20	Volts
R ₁ =	887	453	301	226	182	154	133	118	105	95.3	KOhms

RP240H-xx15SRW

Trim up	1	2	3	4	5	6	7	8	9	10	%
Vout =	15.15	15.30	15.45	15.60	15.75	15.90	16.05	16.20	16.35	16.50	Volts
R ₁ =	1130	576	383	294	237	196	169	150	137	124	KOhms

RP240H-xx24SRW

Trim up	1	2	3	4	5	6	7	8	9	10	%
Vout =	24.24	24.48	24.72	24.96	25.20	25.44	25.68	25.92	26.16	26.40	Volts
R ₁ =	1870	953	634	487	392	332	280	249	226	205	KOhms

RP240H-xx48SRW

Trim up	1	2	3	4	5	6	7	8	9	10	%
Vout =	48.48	48.96	49.44	49.92	50.40	50.88	51.36	51.84	52.32	52.80	Volts
R ₁ =	3830	1960	1300	991	806	681	576	511	464	422	KOhms

Trim Down all Vout's

Trim down	1	2	3	4	5	6	7	8	9	10	%
R ₂ =	97.6	47.5	31.6	23.2	18.2	14.7	12.1	10.5	9.09	8.06	KOhms
Trim down	11	12	13	14	15	16	17	18	19	20	%
R ₂ =	7.15	6.34	5.76	5.11	4.64	4.22	3.92	3.57	3.24	3.01	KOhms

continued on next page

Specifications (measured @ $t_a = 25^\circ\text{C}$, nominal input voltage, full load and after warm-up)

Remote Sense

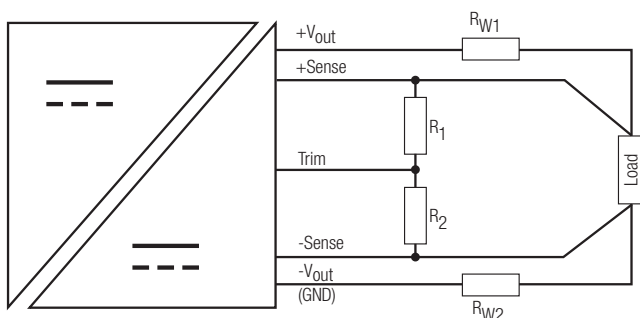

The output voltage can be adjusted by both trim and remote sense. The maximum combined adjustment range $\pm 10\%$. Derate the maximum output power if using the trim or sense function.

R_{W1} ... wire losses +
 R_{W2} ... wire losses -
 R_1 ... trim up resistor
 R_2 ... trim down resistor

REGULATIONS

Parameter	Condition	Value
Output Accuracy		$\pm 1.0\%$
Line Regulation	low line to high line at full load	$\pm 0.1\%$
Load Regulation	0% to 100% load	$\pm 0.1\%$
Transient Response	25% load step change	200 μs typ.; 250 μs max.

Transient Response to Dynamic Load Change from 100% to 75% to 100% of Full Load at nom. V_{in}

RP240H-2405SRW

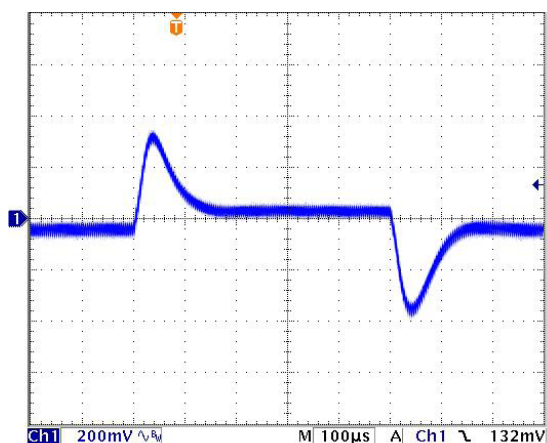

RP240H-4805SRW

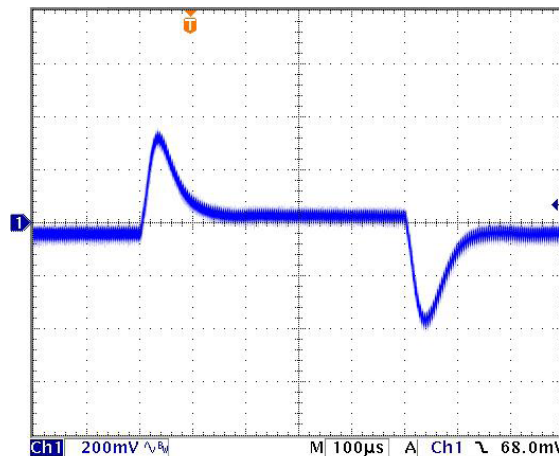

RP240H-11005SRW

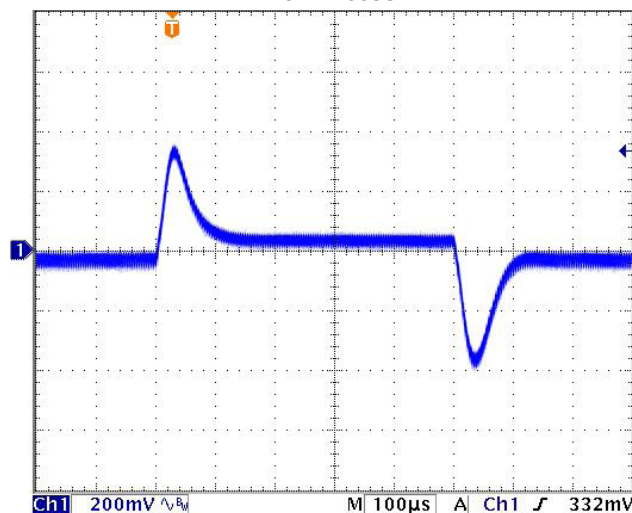

Specifications (measured @ $t_a = 25^\circ\text{C}$, nominal input voltage, full load and after warm-up)

PROTECTIONS			
Parameter	Condition	Value	
Short Circuit Protection (SCP)	below 100mΩ	continuous, automatic recovery	
Over Voltage Protection (OVP)	% of nom. Vout	115%-130%, Hiccup Mode	
Over Load Protection (OLP)	% Iout rated	120%-150%, Hiccup Mode	
Over Temperature Protection (OTP)		+120°C	
Isolation Voltage	110Vin	I/P to O/P I/P or O/P to Baseplate	3kVAC/1 minute 1.5kVAC/1 minute
	24Vin, 48Vin	I/P to O/P I/P or O/P to Baseplate	2.25kVDC/1 minute 1.6kVDC/1 minute
Isolation Resistance	500 VDC	1GΩ min.	
Isolation Capacitance		2500pF max.	
Isolation Grade	110Vin		Reinforced Insulation
	24Vin, 48Vin		Basic Insulation

Notes:

Note4: An input fuse is required if the mains supply isn't over-current protected.

Recommended fuse: 24Vin: 25A slow blow, 48Vin: 15A slow blow and 110Vin: 7.5A slow blow.

ENVIRONMENTAL		
Parameter	Condition	Value
Operating Case Temperature Range	Baseplate	-40°C to +115°C
Maximum Case Temperature		115°C
Temperature Coefficient		±0.02%/°C max.
Thermal Impedance	vertical direction by natural convection (0.1 m/s) without Heat-sink	6.1°C/W
	vertical direction by natural convection (0.1 m/s) with Heat-sink	4.6°C/W
Operating Humidity		5% - 95% RH
Pollution Degree		PD2
Shock		according to EN61373 standard
Thermal Shock		according to MIL-STD-810F standard
Vibration		according to EN61373 standard
Fire protection on railway vehicles		according to EN45545-2, 2013 standard
MTBF	according to MIL-HDBK-217F standard, 25°C	296.1 x 10 ³ hours

Thermal Calculation

$$R_{th\text{case-ambient}} = 6.1^\circ\text{C/W (vertical)}$$

$$R_{th\text{case-ambientHC}} = 4.6^\circ\text{C/W (vertical)}$$

$$R_{th\text{case-ambient}} = \frac{T_{\text{case}} - T_{\text{ambient}}}{P_{\text{dissipation}}}$$

$$P_{\text{dissipation}} = P_{\text{IN}} - P_{\text{OUT}} = \frac{P_{\text{OUTapp}}}{\eta} - P_{\text{OUTapp}}$$

T_{case} = Case Temperature

T_{ambient} = Environment Temperature

$P_{\text{dissipation}}$ = Internal losses

P_{IN} = Input Power

P_{OUT} = Output Power

η = Efficiency under given Operating Conditions

$R_{th\text{case-ambient}}$ = Thermal Impedance

Practical Example:

Take the RP240H-2405SRW with 9V input Voltage and 50% load. What is the maximum ambient operating temperature? Use converter vertical in application without airflow.

$$\text{Eff}_{\text{min}} = 91.5\% @ V_{\text{nom}}$$

$$P_{\text{OUT}} = 180\text{W}$$

$$P_{\text{OUTapp}} = 180 \times 0.5 = 90\text{W}$$

$$\eta = 91.5\% \text{ (Efficiency vs. Load Graph)}$$

$$P_{\text{dissipation}} = \frac{90}{0.915} - 90 = 8.36\text{W}$$

without Heat-sink

$$R_{th} = \frac{T_{\text{casemax}} - T_{\text{amb}}}{P_{\text{dissipation}}} \rightarrow 6.1^\circ\text{C/W} = \frac{115 - T_{\text{amb}}}{8.36\text{W}}$$

$$T_{\text{amb}} = 64^\circ\text{C}$$

with Heat-sink

$$R_{thHC} = \frac{T_{\text{casemax}} - T_{\text{amb}}}{P_{\text{dissipation}}} \rightarrow 4.6^\circ\text{C/W} = \frac{115 - T_{\text{amb}}}{8.36\text{W}}$$

$$T_{\text{ambHC}} = 76.5^\circ\text{C}$$

continued on next page

Specifications (measured @ $t_a = 25^\circ\text{C}$, nominal input voltage, full load and after warm-up)

Derating Graph⁽⁵⁾

(⁵ Chamber - tested with forced convection)

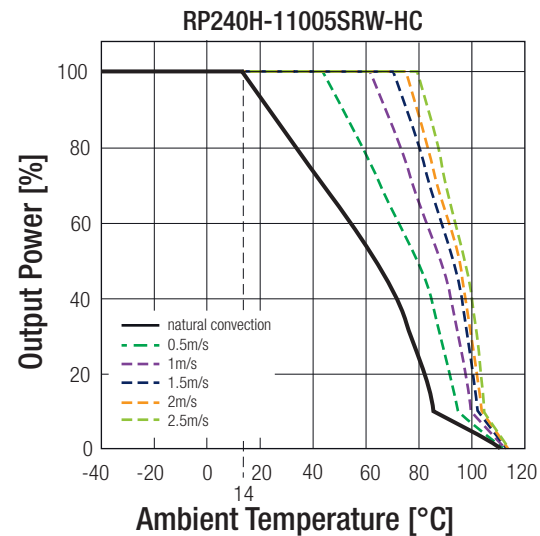
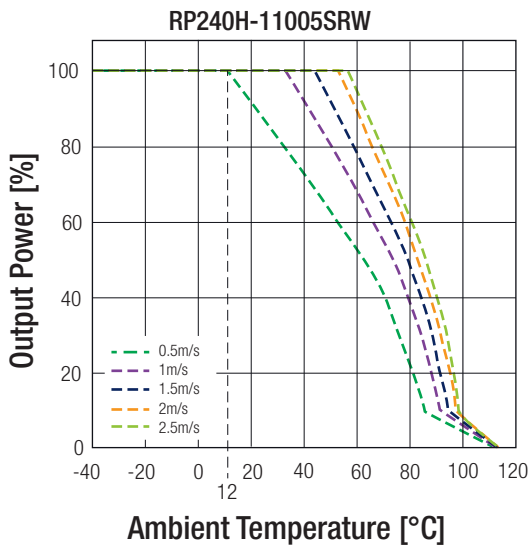
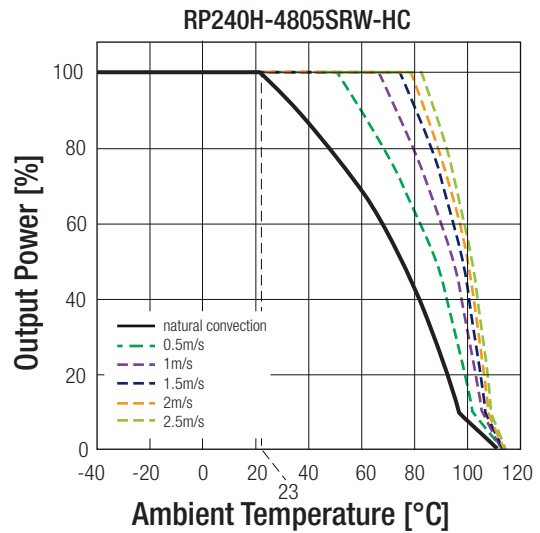
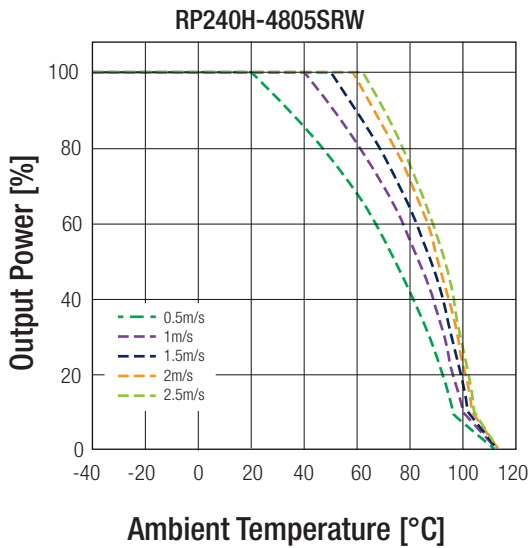
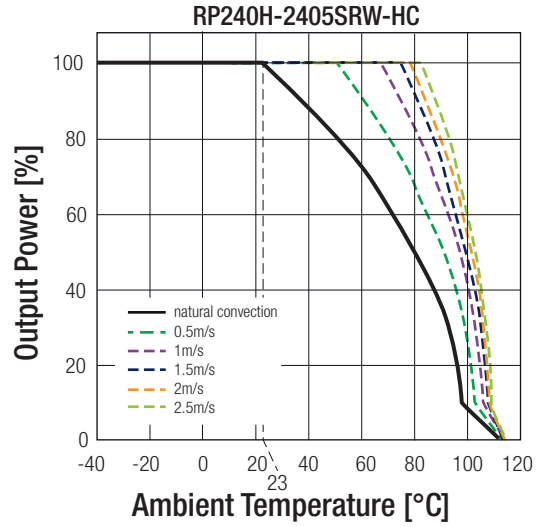
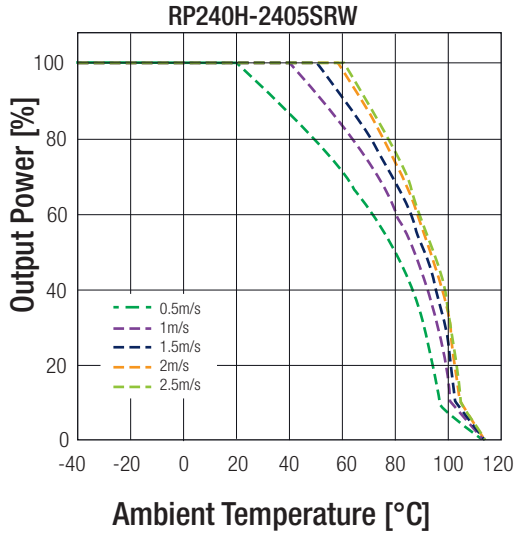

Notes:

Note5: Derating graphs are valid only for the shown part numbers. If you need detailed derating-information about a part-number not shown here please contact our technical support service at techsupportAT@recom-power.com

Specifications (measured @ $t_a = 25^\circ\text{C}$, nominal input voltage, full load and after warm-up)

SAFETY AND CERTIFICATIONS		
Certificate Type (Safety)	Report / File Number	Standard
Information Technology Equipment, General Requirements for Safety	E196683	UL60950-1, 2nd Edition CSA C22.2 No. 60950-1-07
IEC/EN Information Technology Equipment - General Requirements for Safety	pending	IEC/EN60950-1
Railway Applications - Electrical Equipment used on rolling stock	pending	EN50155
EMI Compliance	Condition	Standard / Criterion
Information technology equipment - Radio disturbance characteristics - Limits and methods of measurement	with external components	EN55022, Class A and Class B
Industrial, scientific and medical equipment - Radio frequency disturbance characteristics - Limits and methods of measurement		EN55011, Class A and Class B
ESD Electrostatic discharge immunity test	Air $\pm 8\text{kV}$ and Contact $\pm 6\text{kV}$ 20 V/m $\pm 2\text{kV}$ EN55024 & EN50155 $\pm 2\text{kV}$ 10 Vr.m.s 100A/m continuous; 1000A/m 1s	EN61000-4-2, Criteria A
Radiated, radio-frequency, electromagnetic field immunity test		EN61000-4-3, Criteria A
Fast Transient and Burst Immunity ⁽⁶⁾		EN61000-4-4, Criteria A
Surge Immunity ⁽⁶⁾		EN61000-4-5, Criteria A
Immunity to conducted disturbances, induced by radio-frequency fields		EN61000-4-6, Criteria A
Power Magnetic Field Immunity		EN61000-4-8, Criteria A

Notes:

Note6: An external input filter capacitor is required if the module has to meet EN61000-4-4 and EN61000-4-5.

The **24Vin** and **48Vin** version recommend 2pcs of aluminium electrolytic capacitor to connect in parallel.
Recom suggest: Nippon Chemi-con KY series, 220 μF /100V.

The **110Vin** version recommend 3pcs of aluminium electrolytic capacitor to connect in parallel.
Recom suggest: Rubycon BXF series, 100 μF /250V

EMI Filtering according to EN55022/11Class A and EN50121-1

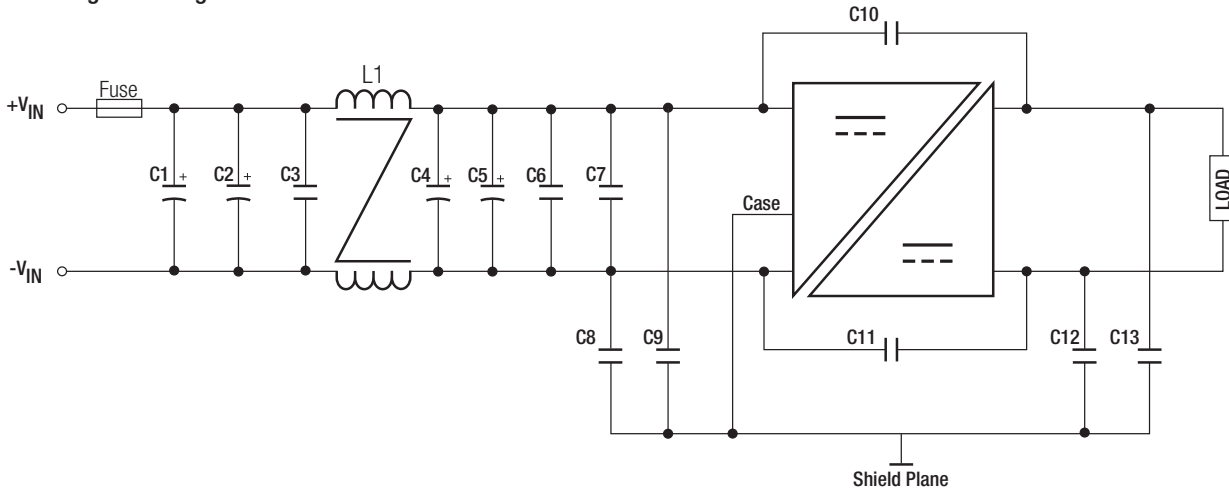

MODEL	C1, C2, C4, C5	C3, C6, C7	C8, C9, C10, C11, C13	C12	L1	
RP240H-24xxSRW	470 μF , 50V Al cap. (lie down) Chemi-con KY	4.7 μF , 50V 1812 MLCC	1000pF, 3kV 1808 MLCC	3300pF, 3kV 1808 MLCC	45 μH CMC	
RP240H-48xxSRW	220 μF , 100V Al cap. (lie down) Chemi-con KY	2.2 μF , 100V 1812 MLCC		1000pF, 3kV 1808 MLCC	1000pF, 3kV 1808 MLCC	224 μH CMC
RP240H-110xxSRW	150 μF , 200V Al cap. (lie down) Chemi-con KXJ	1 μF , 250V 1812 MLCC				521 μH CMC

continued on next page

Specifications (measured @ $t_a = 25^\circ\text{C}$, nominal input voltage, full load and after warm-up)

RP240H-2405SRW

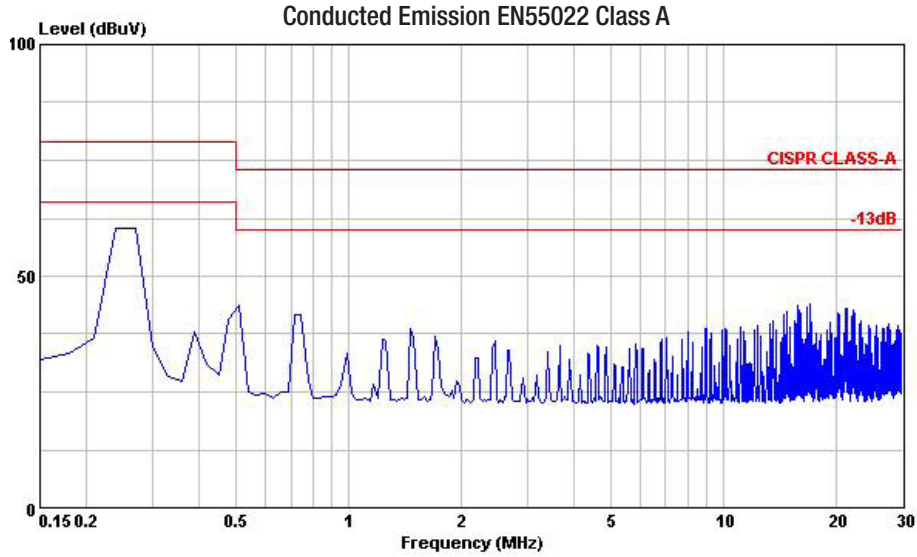

RP240H-4805SRW

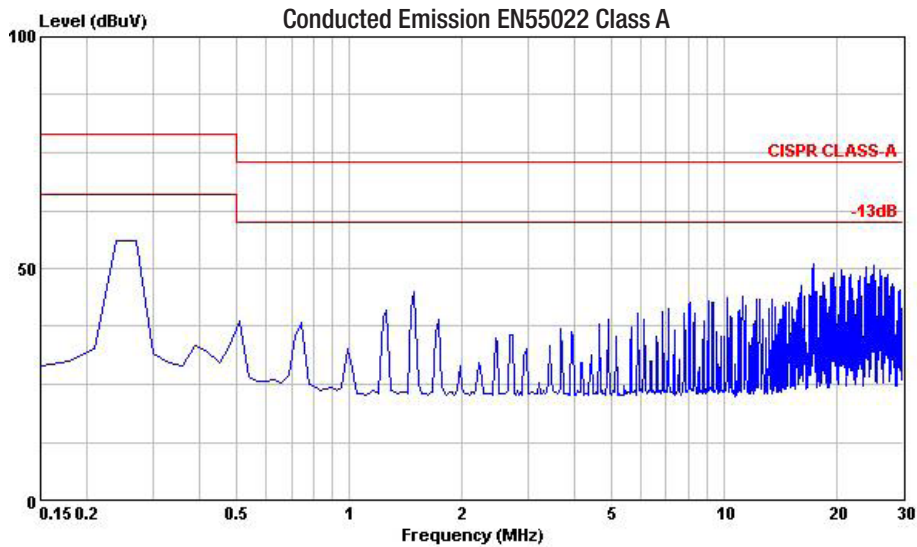

RP240H-11005SRW

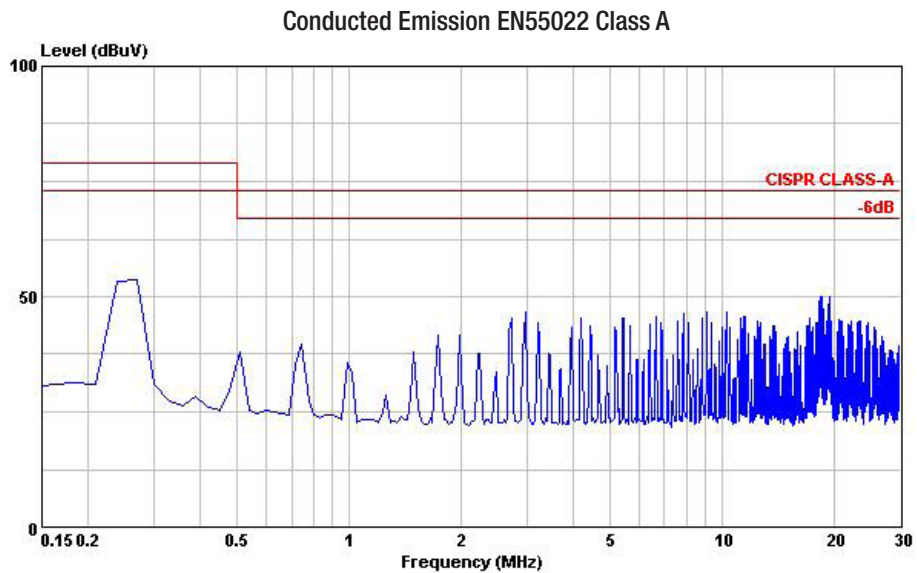

continued on next page

Specifications (measured @ $t_a = 25^\circ\text{C}$, nominal input voltage, full load and after warm-up)

EMI Filtering according to EN55022/11 Class B

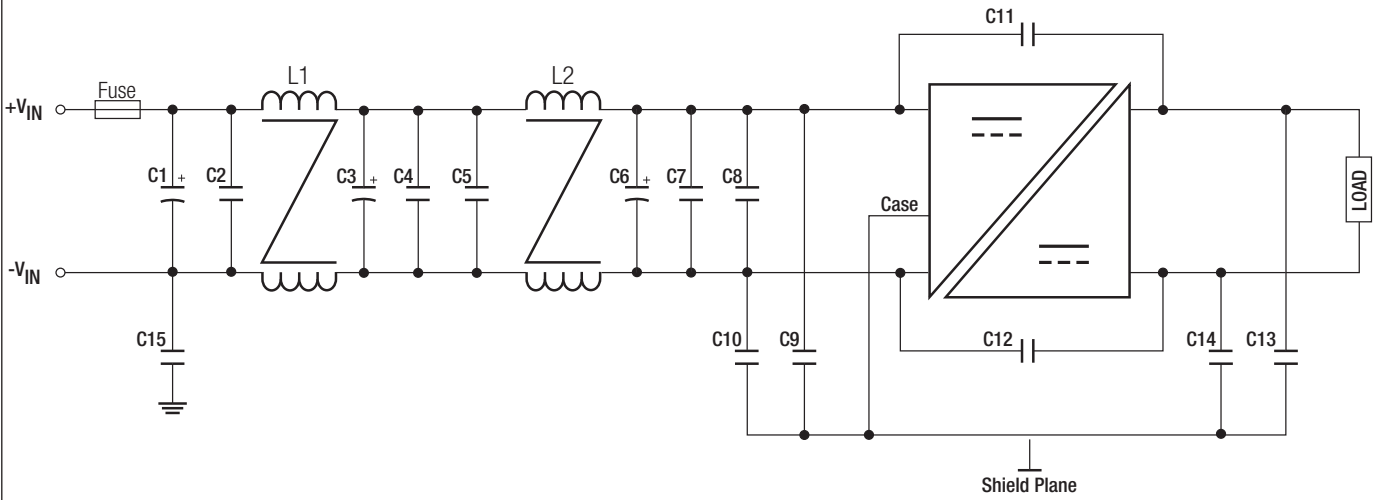

MODEL	C1, C3, C6	C2, C4, C5, C7, C8	C9, C10	C11	C12	C13, C14	C15	L1, L2
RP240H-24xxSRW	470 μF , 50V Al cap. (lie down) Chemi-con KY	4.7 μF , 50V 1812 MLCC	10nF, 2kV 1812 MLCC	1000pF, 3kV 1808 MLCC	4700pF, 3kV 1812 MLCC	10nF, 2kV 1812 MLCC	N/A	45 μH CMC
RP240H-48xxSRW	220 μF , 100V Al cap. (lie down) Chemi-con KY	2.2 μF , 100V 1812 MLCC	10nF, 2kV 1812 MLCC	2200pF, 3kV 1808 MLCC	4700pF, 3kV 1812 MLCC	10nF, 2kV 1812 MLCC	1000pF, 3kV 1808 MLCC	224 μH CMC
RP240H-110xxSRW	150 μF , 200V Al cap. (lie down) Chemi-con KXJ	1 μF , 250V 1812 MLCC	2200pF, 3kV 1808 MLCC	2200pF, 3kV 1808 MLCC	2200pF, 3kV 1808 MLCC	1000pF, 3kV 1808 MLCC	1000pF, 3kV 1808 MLCC	521 μH CMC

RP240H-2405SRW

Conducted Emission EN55022 Class B

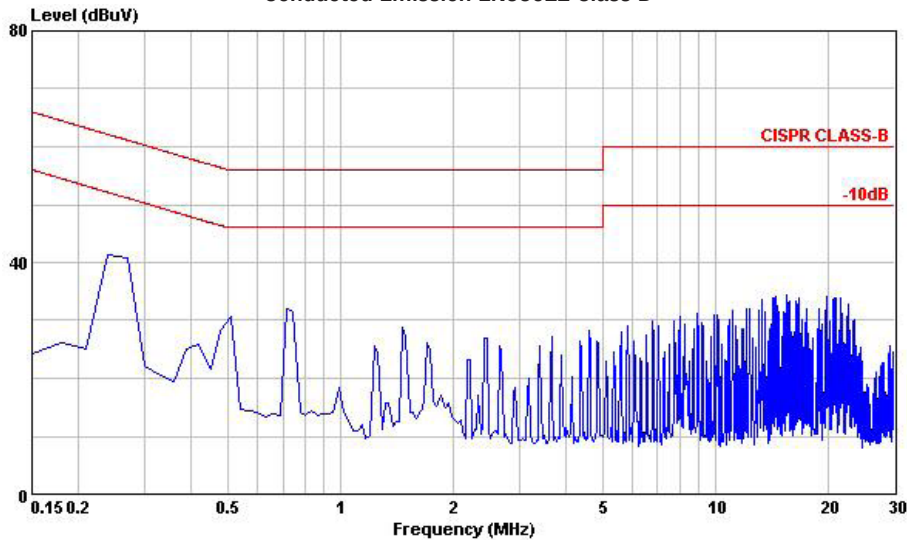

continued on next page

Specifications (measured @ ta= 25°C, nominal input voltage, full load and after warm-up)

RP240H-4805SRW

Conducted Emission EN55022 Class B

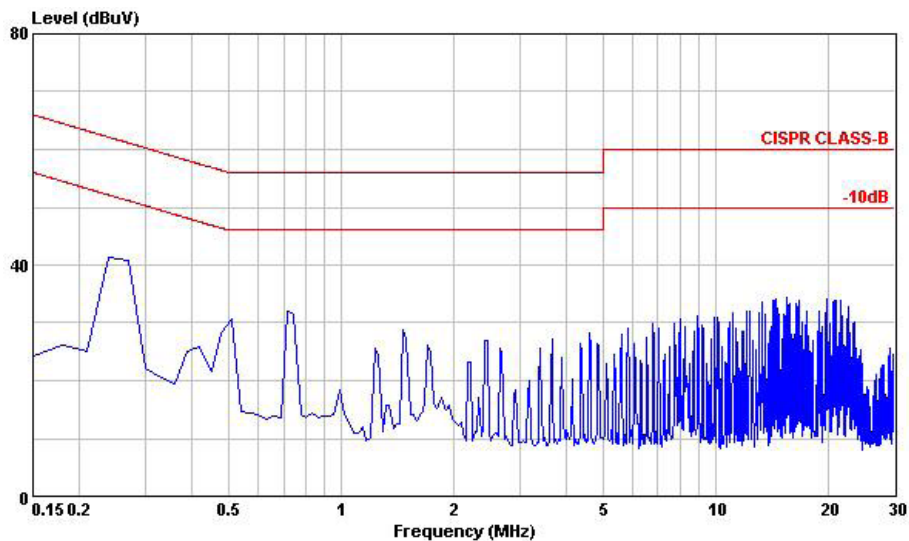

RP240H-11005SRW

Conducted Emission EN55022 Class B

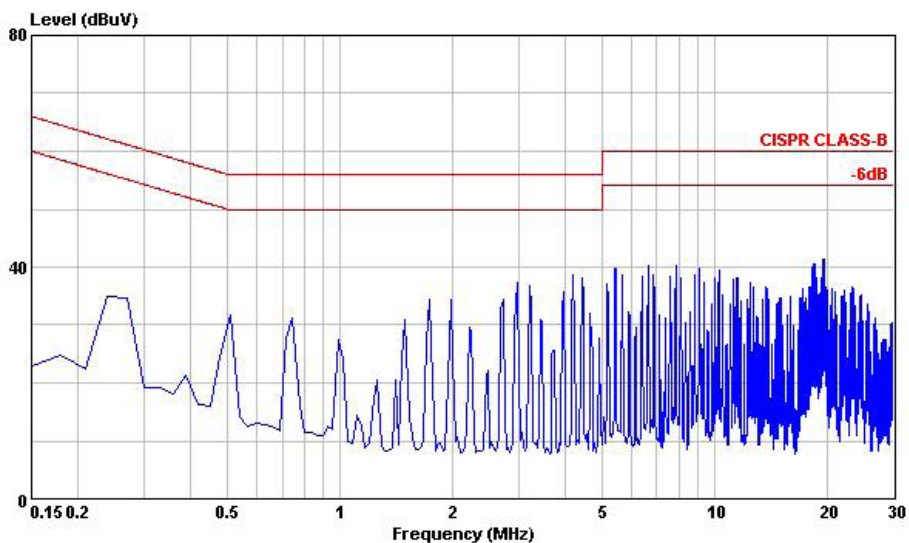

DIMENSIONS and PHYSICAL CHARACTERISTICS

Parameter	Type	Value
Material	Case	24Vin, 48Vin 110Vin Metal Plastic
	Baseplate	110Vin Aluminium
	Potting	Silicone (UL94 V-0)
Packaging Dimension (LxWxH)	without Heat-sink with Heat-sink	61.0 x 57.9 x 12.7mm 61.0 x 57.9 x 24.13mm
Packaging Weight	without Heat-sink with Heat-sink	105g 157g

continued on next page

Specifications (measured @ $t_a = 25^\circ\text{C}$, nominal input voltage, full load and after warm-up)

Dimension Drawing (mm)

24Vin, 48Vin

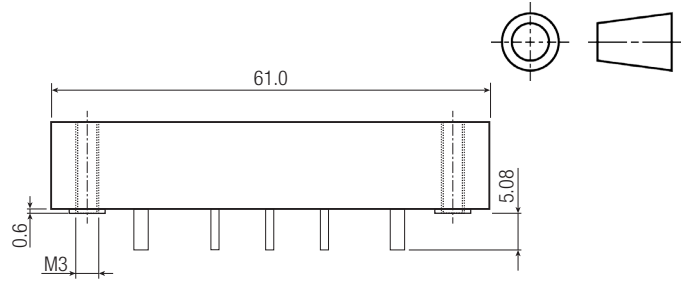
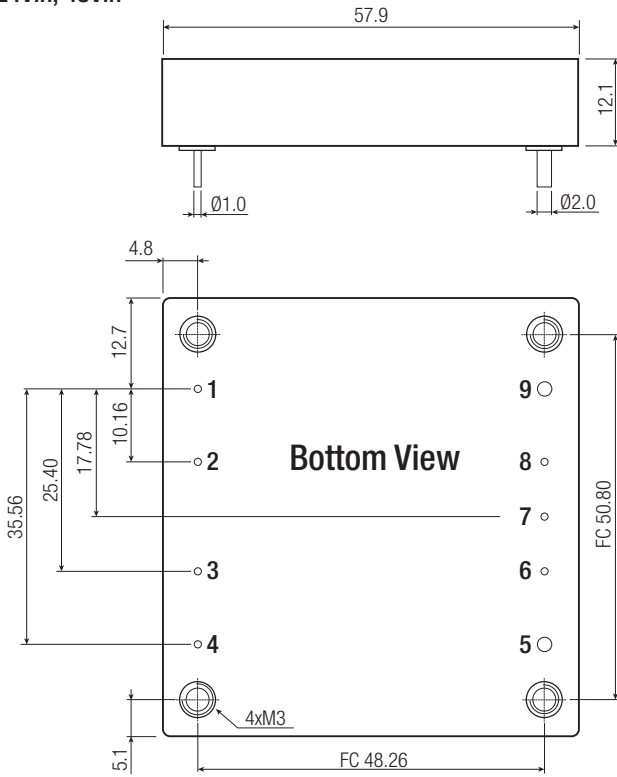

Pin Connections

Pin #	Single
1	-Vin
2	Case
3	CTRL
4	+Vin
5	+Vout
6	+Sense
7	Trim
8	-Sense
9	-Vout

FC= Fixing Centers for Heat Sink
 Pin Pitch Tolerance $\pm 0.25\text{mm}$
 Pin Dimension Tolerance $\pm 0.1\text{mm}$
 XX.X $\pm 0.5\text{mm}$
 XX.XX $\pm 0.25\text{mm}$

110Vin

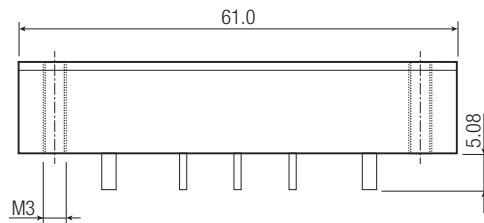
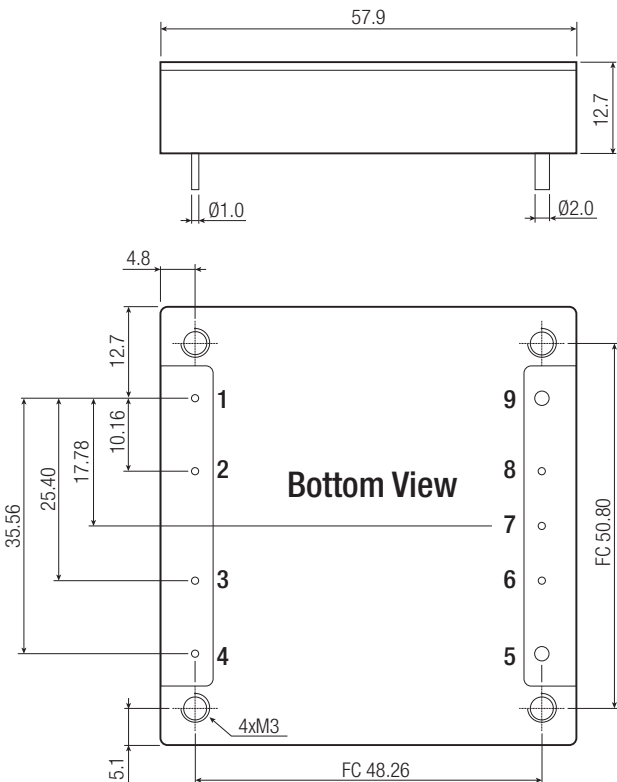

Pin Connections

Pin #	Single
1	-Vin
2	Case
3	CTRL
4	+Vin
5	+Vout
6	+Sense
7	Trim
8	-Sense
9	-Vout

FC= Fixing Centers for Heat Sink
 Pin Pitch Tolerance $\pm 0.25\text{mm}$
 Pin Dimension Tolerance $\pm 0.1\text{mm}$
 XX.X $\pm 0.5\text{mm}$
 XX.XX $\pm 0.25\text{mm}$

continued on next page

Specifications (measured @ ta= 25°C, nominal input voltage, full load and after warm-up)

110Vin with Heat-sink

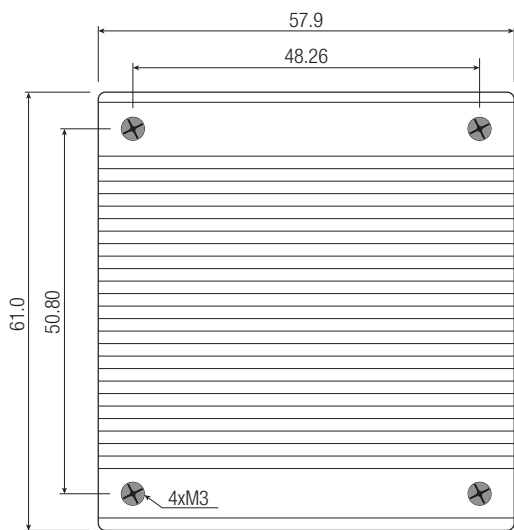

Notes:

Note7: Max. tightening torque for Heat-sink: 0.34Nm

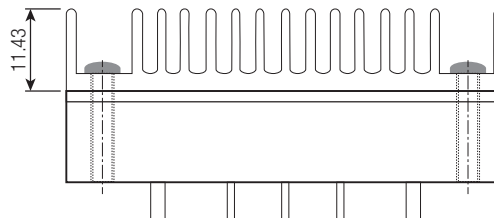
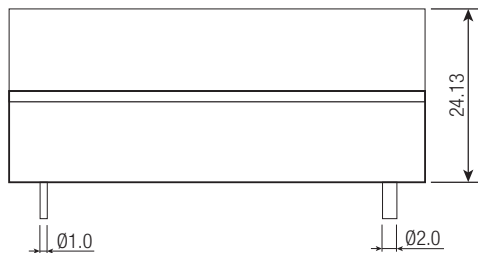

PACKAGING INFORMATION

Parameter	Type	Value
Packaging Dimension	without Heat-sink	157.0 x 88.0 x 12.8mm
	with Heat-sink	157.0 x 88.0 x 24.8mm
Packaging Quantity		2pcs.
Storage Temperature Range		-55°C to +125°C
Storage Humidity		5% - 95% RH

The product information and specifications are subject to change without prior notice. RECOM products are not authorized for use in safety-critical applications (such as life support) without RECOM's explicit written consent. A safety-critical application is defined as an application where a failure of a RECOM product may reasonably be expected to endanger or cause loss of life, inflict bodily harm or damage property. The buyer shall indemnify and hold harmless RECOM, its affiliated companies and its representatives against any damage claims in connection with the unauthorized use of RECOM products in such safety-critical applications.