



## STR73xFxx

ARM7TDMI™ 32-bit MCU with Flash, 3x CAN,  
4 UARTs, 20 timers, ADC, 12 comm. interfaces

### Features

- **Core**
  - ARM7TDMI 32-bit RISC CPU
  - 32 MIPS @ 36 MHz
- **Memories**
  - Up to 256 Kbytes Flash program memory (10,000 cycles endurance, data retention 20 years @ 85° C)
  - 16 Kbytes RAM
- **Clock, reset and supply management**
  - 4.5 - 5.5 V application supply and I/Os
  - Embedded 1.8 V regulator for core supply
  - Embedded oscillator running from external 4-8 MHz crystal or ceramic resonator
  - Up to 36 MHz CPU frequency with internal PLL
  - 32 kHz or 2 MHz internal RC oscillator, software configurable for fast startup and backup clock
  - Real-time clock for clock-calendar function
  - Wake-up timer driven by internal RC for wake-up from STOP mode
  - 5 power saving modes: SLOW, WFI, LPWFI, STOP and HALT modes
- **Nested interrupt controller**
  - Fast interrupt handling with multiple vectors
  - 64 maskable IRQs with 64 vectors and 16 priority levels
  - 2 maskable FIQ sources
  - 16 external interrupts, up to 32 wake-up lines
- **Up to 112 I/O ports**
  - 72/112 multifunctional bidirectional I/Os

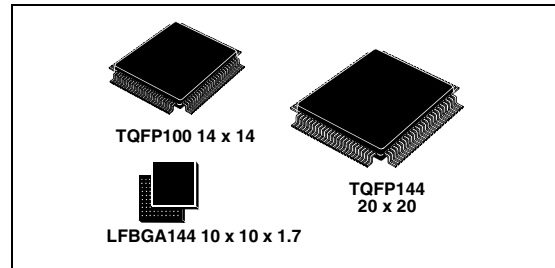

- **DMA**
  - 4 DMA controllers with 4 channels each
- **Timers**
  - 16-bit watchdog timer (WDG)
  - 6/10 16-bit timers (TIM) each with: 2 input captures, 2 output compares, PWM and pulse counter modes
  - 6 16-bit PWM modules (PWM)
  - 3 16-bit timebase timers with 8-bit prescalers
- **12 communications interfaces**
  - 2 I<sup>2</sup>C interfaces
  - 4 UART asynchronous serial interfaces
  - 3 BSPI synchronous serial interfaces
  - Up to 3 CAN interfaces (2.0B Active)
- **10-bit A/D converter**
  - 12/16 channels
  - Conversion time: min. 3 μs, range: 0 to 5V
- **Development tools support**
  - JTAG interface

Table 1. Device summary

Reference	Part number
STR73xFxx	STR730FZ1, STR730FZ2, STR731FV0, STR731FV1, STR731FV2, STR735FZ1, STR735FZ2, STR736FV0, STR736FV1, STR736FV2

# Contents

<b>1</b>	<b>Scope</b> .....	<b>4</b>
1.1	Description .....	4
<b>2</b>	<b>Overview</b> .....	<b>5</b>
2.1	On-chip peripherals .....	6
<b>3</b>	<b>Block diagram</b> .....	<b>8</b>
3.1	Related documentation .....	10
3.2	Pin description .....	11
3.2.1	STR730F/STR735F (TQFP144) .....	11
3.2.2	STR730F/STR735F (LFBGA144) .....	12
3.2.3	STR731F/STR736F (TQFP100) .....	13
3.3	Memory mapping .....	20
<b>4</b>	<b>Electrical parameters</b> .....	<b>21</b>
4.1	Parameter conditions .....	21
4.1.1	Minimum and maximum values .....	21
4.1.2	Typical values .....	21
4.1.3	Typical curves .....	21
4.1.4	Loading capacitor .....	21
4.1.5	Pin input voltage .....	21
4.2	Absolute maximum ratings .....	22
4.3	Operating conditions .....	24
4.3.1	Supply current characteristics .....	25
4.3.2	Clock and timing characteristics .....	29
4.3.3	Memory characteristics .....	34
4.3.4	EMC characteristics .....	35
4.3.5	I/O port pin characteristics .....	38
4.3.6	10-bit ADC characteristics .....	43
<b>5</b>	<b>Package characteristics</b> .....	<b>46</b>
5.1	Package mechanical data .....	46
5.2	Thermal characteristics .....	48

---

<b>6</b>	<b>Order codes</b> .....	<b>49</b>
<b>7</b>	<b>Known limitations</b> .....	<b>50</b>
	7.1 Low power wait for interrupt mode .....	50
	7.2 PLL free running mode at high temperature .....	50
<b>8</b>	<b>Revision history</b> .....	<b>51</b>

# 1 Scope

This datasheet provides the STR73x ordering information, mechanical and electrical device characteristics.

For complete information on the STR73xF microcontroller memory, registers and peripherals, please refer to the STR73x reference manual.

For information on programming, erasing and protection of the internal Flash memory please refer to the STR7 Flash programming reference manual.

For information on the ARM7TDMI core please refer to the ARM7TDMI technical reference manual.

## 1.1 Description

### ARM core with embedded Flash & RAM

STR73xF family combines the high performance ARM7TDMI™ CPU with an extensive range of peripheral functions and enhanced I/O capabilities. All devices have on-chip high-speed single voltage Flash memory and high-speed RAM. The STR73xF family has an embedded ARM core and is therefore compatible with all ARM tools and software.

### Extensive tools support

STMicroelectronics' 32-bit, ARM core-based microcontrollers are supported by a complete range of high-end and low-cost development tools to meet the needs of application developers. This extensive line of hardware/software tools includes starter kits and complete development packages all tailored for ST's ARM core-based MCUs.

The range of development packages includes third-party solutions that come complete with a graphical development environment and an in-circuit emulator/programmer featuring a JTAG application interface. These support a range of embedded operating systems (OS), while several royalty-free OSs are also available.

For more information, please refer to ST MCU site <http://www.st.com/mcu>

*Figure 1* shows the general block diagram of the device family.



## 2 Overview

**Table 2. Product overview**

Features	STR730FZx		STR735FZx		STR731FVx			STR736FVx		
Flash memory - bytes	128K	256K	128K	256K	64K	128K	256K	64K	128K	256K
RAM - bytes	16 K				16 K					
Peripheral functions	10 TIM timers, 112 I/Os, 32 wake-up lines, 16 ADC				6 TIM timers, 72 I/Os, 18 wake-up lines, 12 ADC channels					
CAN peripherals	3		0		3			0		
Operating voltage	4.5 to 5.5 V									
Operating temperature	-40 to +85°C/-40 to +105° C									
Packages	T=TQFP144 20 x 20 H=LFBGA144 10 x10				T=TQFP100 14x14					

**Package choice: reduced pin-count TQFP100 or feature-rich 144-pin TQFP or LFBGA**

The STR73xF family is available in 3 packages. The TQFP144 and LFBGA144 versions have the full set of all features. The 100-pin version has fewer timers, I/Os and ADC channels. Refer to the Device Summary on Page 1 for a comparison of the I/Os available on each package.

The family includes versions with and without CAN.

**High speed Flash memory**

The Flash program memory is organized in 32-bit wide memory cells which can be used for storing both code and data constants. It is accessed by CPU with zero wait states @ 36 MHz.

The STR7 embedded Flash memory can be programmed using in-circuit programming or in-application programming.

The Flash memory endurance is 10K write/erase cycles and the data retention is 20 years @ 85° C.

**IAP (in-application programming):** IAP is the ability to re-program the Flash memory of a microcontroller while the user program is running.

**ICP (in-circuit programming):** ICP is the ability to program the Flash memory of a microcontroller using JTAG protocol while the device is mounted on the user application board.

The Flash memory can be protected against different types of unwanted access (read/write/erase). There are two types of protection:

- Sector write protection
- Flash debug protection (locks JTAG access)

**Flexible power management**

To minimize power consumption, you can program the STR73xF to switch to SLOW, WFI LPWFI, STOP or HALT modes depending on the current system activity in the application.

**Flexible clock control**

Two clock sources are used to drive the microcontroller, a main clock driven by an external crystal or ceramic resonator and an internal backup RC oscillator that operates at 2 MHz or 32 kHz. The embedded PLL can be configured to generate an internal system clock of up to 36 MHz. The PLL output frequency can be programmed using a wide selection of multipliers and dividers.

**Voltage regulators**

The STR73xF requires an external 4.5 to 5.5 V power supply. There are two internal Voltage Regulators for generating the 1.8 V power supply needed by the core and peripherals. The main VR is switched off and the Low Power VR switched on when the application puts the STR73xF in Low Power Wait for Interrupt (LPWFI) mode.

**Low voltage detectors**

The voltage regulator and Flash modules each have an embedded LVD that monitors the internal 1.8 V supply. If the voltage drops below a certain threshold, the LVD will reset the STR73xF.

*Note:* An external power-on reset must be provided ensure the microcontroller starts-up correctly.

## 2.1 On-chip peripherals

**CAN interfaces**

The three CAN modules are compliant with the CAN specification V2.0 part B (active). The bit rate can be programmed up to 1 Mbaud. These are not available in the STR735 and STR736.

**DMA**

4 DMA controllers, each with 4 data streams manage memory to memory, peripheral to peripheral, peripheral to memory and memory to peripheral transfers. The DMA requests are connected to TIM timers, BSPI0, BSP11, BSP12 and ADC. One of the streams can be configured to be triggered by a software request, independently from any peripheral activity.

**16-bit timers (TIM)**

Each of the ten timers (six in 100-pin devices) have a 16-bit free-running counter with 7-bit prescaler, up to two input capture/output compare functions, a pulse counter function, and a PWM channel with selectable frequency. This provides a total of 16 independent PWMs (12 in 100-pin devices) when added with the PWM modules (see next paragraph).

**PWM modules (PWM)**

The six 16-bit PWM modules have independently programmable periods and duty-cycles, with 5+3 bit prescaler factor.

**Timebase timers (TB)**

The three 16-bit timebase timers with 8-bit prescaler for general purpose time triggering operations.

**Real-time clock (RTC)**

The RTC provides a set of continuously running counters driven by separate clock signal derived from the main oscillator. The RTC can be used as a general timebase or

clock/calendar/alarm function. When the STR73xF is in LPWFI mode the RTC keeps running, powered by the low power voltage regulator.

#### **UARTs**

The 4 UARTs allow full duplex, asynchronous, communications with external devices with independently programmable TX and RX baud rates up to 625 Kbaud.

#### **Buffered serial peripheral interfaces (BSPI)**

Each of the three BSPIs allow full duplex, synchronous communications with external devices, master or slave communication at up to 6 Mb/s in master mode and up to 4.5 Mb/s in slave mode (@36 MHz system clock).

#### **I<sup>2</sup>C interfaces**

The two I<sup>2</sup>C Interfaces provide multi-master and slave functions, support normal and fast I<sup>2</sup>C mode (400 kHz) and 7 or 10-bit addressing modes.

#### **A/D converter**

The 10-bit analog to digital converter, converts up to 16 channels in single-shot or continuous conversion modes (12 channels in 100-pin devices). The minimum conversion time is 3  $\mu$ s.

#### **Watchdog**

The 16-bit watchdog timer protects the application against hardware or software failures and ensures recovery by generating a reset.

#### **I/O ports**

Up to 112 I/O ports (72 in 100-pin devices) are programmable as general purpose input/output or alternate function.

#### **External interrupts and wake-up lines**

16 external interrupts lines are available for application use. In addition, up to 32 external Wake-up lines (18 in 100-pin devices) can be used as general purpose interrupts or to wake-up the application from STOP mode.

### 3 Block diagram

Figure 1. STR730F/STR735F block diagram

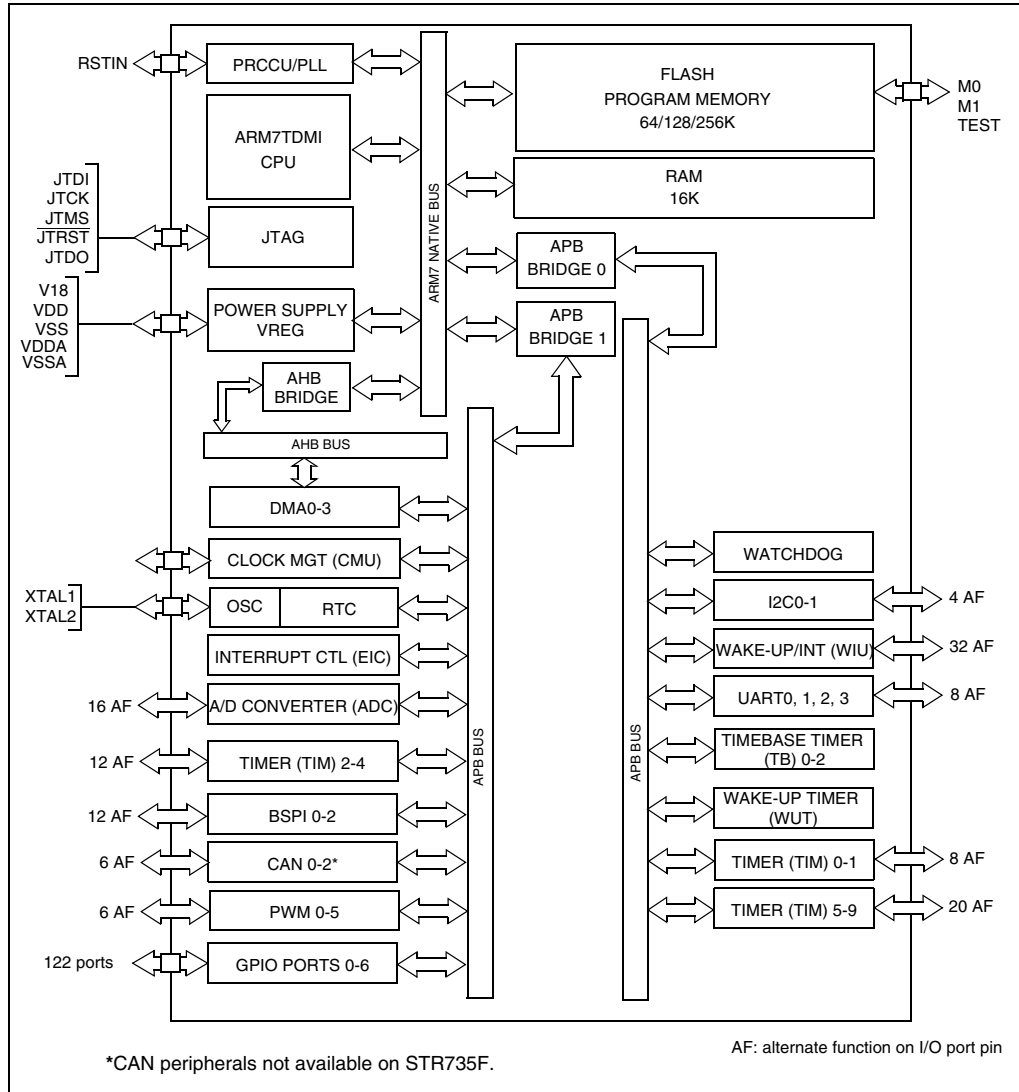
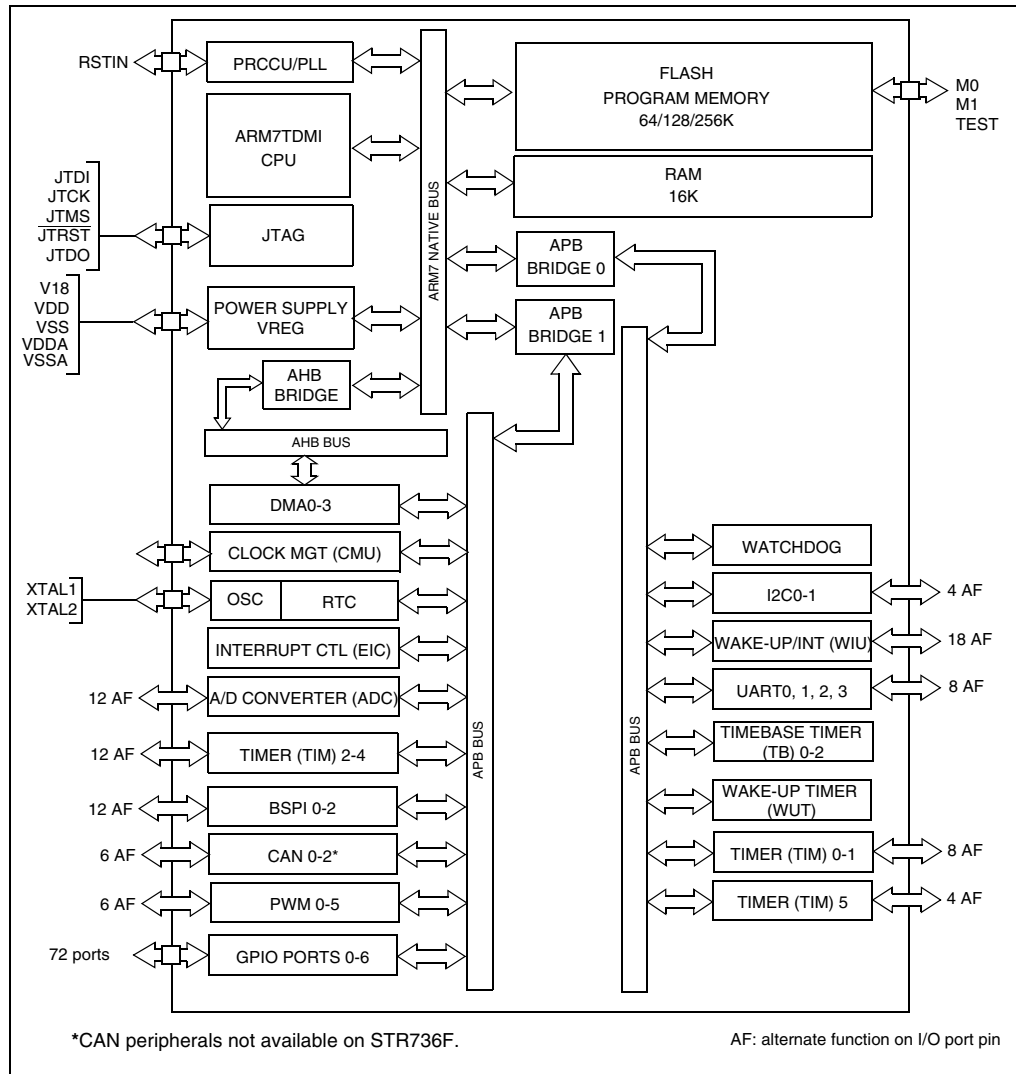



Figure 2. STR731F/STR736 block diagram



### 3.1 Related documentation

**Available from [www.arm.com](http://www.arm.com):**

ARM7TDMI technical reference manual

**Available from <http://www.st.com>:**

STR73x reference manual (RM0001)

STR7 Flash programming reference manual

STR73x software library user manual

For a list of related application notes refer to <http://www.st.com>.

### 3.2 Pin description

#### 3.2.1 STR730F/STR735F (TQFP144)

Figure 3. STR730F/STR735F pin configuration (top view)

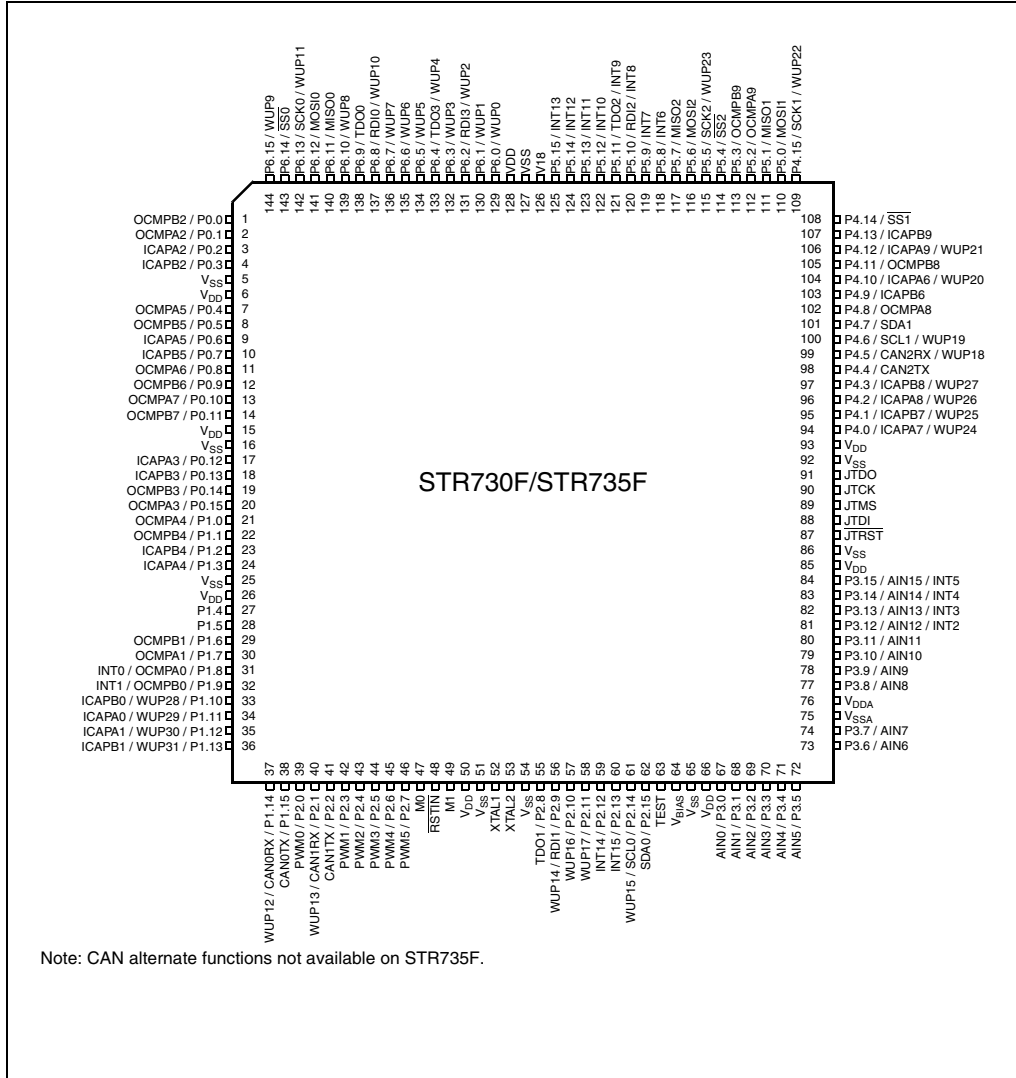

### 3.2.2 STR730F/STR735F (LFBGA144)

Table 3. STR730F/STR735F LFBGA ball connections

Ball	Name	Ball	Name	Ball	Name	Ball	Name
A1	P0.0 / OCMPB2	B1	P0.4 / OCMPA5	C1	P0.5 / OCMPB5	D1	V <sub>SS</sub>
A2	P6.10 / WUP8	B2	P0.1 / OCMPA2	C2	P0.2 / ICAPA2	D2	V <sub>DD</sub>
A3	P6.9 / TDO0	B3	P6.15 / WUP9	C3	P0.3 / ICAPB2	D3	P0.6 / ICAPA5
A4	P6.12 / MOSI0	B4	P6.13 / SCK0 / WUP11	C4	P6.14 / SSO	D4	P0.7 / ICAPB5
A5	P6.6 / WUP6	B5	P6.7 / WUP7	C5	P6.8 / RDI0 / WUP10	D5	P6.11 / MISO0
A6	V <sub>18</sub>	B6	P6.2 / WUP2 / RDI3	C6	P6.3 / WUP3	D6	P6.4 / WUP4 / TDO3
A7	P5.15 / INT13	B7	P5.14 / INT12	C7	V <sub>SS</sub>	D7	V <sub>DD</sub>
A8	P5.8 / INT6	B8	P5.9 / INT7	C8	P5.10 / INT8 / RDI2	D8	P5.12 / INT10
A9	P5.2 / OCMPA9	B9	P5.3 / OCMPB9	C9	P5.4 / SS2	D9	P5.5 / SCK2 / WUP23
A10	P5.7 / MISO2	B10	P5.0 / MOSI1	C10	P5.1 / MISO1	D10	P4.13 / ICAPB9
A11	P5.6 / MOSI2	B11	P4.15 / SCK1 / WUP22	C11	P4.14 / SS1	D11	P4.12 / ICAPA9 / WUP21
A12	P5.11 / TDO2 / INT9	B12	P4.8 / OCMPA8	C12	P4.7 / SDA1	D12	P4.11 / OCMPB8
E1	P0.8 / OCMPA6	F1	V <sub>DD</sub>	G1	V <sub>SS</sub>	H1	V <sub>DD</sub>
E2	P0.9 / OCMPB6	F2	P0.13 / ICAPB3	G2	P1.2 / ICAPB4	H2	P1.8 / OCMPA0 / INT0
E3	P0.10 / OCMPA7	F3	P0.14 / OCMPB3	G3	P1.3 / ICAPA4	H3	P1.9 / OCMPB0 / INT1
E4	P0.11 / OCMPB7	F4	P0.15 / OCMPA3	G4	V <sub>SS</sub>	H4	P1.10 / ICAPB0 / WUP28
E5	P0.12 / ICAPA3	F5	P1.0 / OCMPA4	G5	P1.5	H5	XTAL2
E6	P6.5 / WUP5	F6	P1.1 / OCMPB4	G6	P2.11 / WUP17	H6	P2.10 / WUP16
E7	P6.0 / WUP0	F7	P6.1 / WUP1	G7	P4.0 / ICAPA7 / WUP24	H7	P2.15 / SDA 0
E8	P5.13 / INT11	F8	P4.4 / CAN2TX <sup>1)</sup>	G8	V <sub>DD</sub>	H8	JTMS
E9	P4.10 / ICAPA6 / WUP20	F9	P4.3 / ICAPB8 / WUP27	G9	V <sub>SS</sub>	H9	V <sub>SS</sub>
E10	P4.9 / ICAPB6	F10	P4.2 / ICAPA8 / WUP26	G10	JTDO	H10	V <sub>DD</sub>
E11	P4.6 / SCL1 / WUP19	F11	P4.1 / ICAPB7 / WUP25	G11	JTCK	H11	P3.15 / AIN15 / INT5
E12	P4.5 / WUP18 / CAN2RX <sup>1)</sup>	F12	JTDI	G12	nJTRST	H12	P3.14 / AIN14 / INT4
J1	P1.4	K1	P1.6 / OCMPB1	L1	P1.7 / OCMPA1	M1	P1.14 / CAN0RX <sup>1)</sup> / WUP12
J2	P1.11 / ICAPA0 / WUP29	K2	P1.13 / ICAPB1 / WUP31	L2	P1.15 / CAN0TX <sup>1)</sup>	M2	P2.4 / PWM2
J3	P1.12 / ICAPA1 / WUP30	K3	P2.1 / CAN1RX <sup>1)</sup> / WUP13	L3	P2.0 / PWM0	M3	P2.5 / PWM3
J4	P2.7 / PWM5	K4	P2.6 / PWM4	L4	P2.3 / PWM1	M4	P2.2 / CAN1TX <sup>1)</sup>
J5	V <sub>DD</sub>	K5	M1	L5	RSTIN	M5	M0
J6	P2.9 / RDI1 / WUP14	K6	P2.8 / TDO1	L6	V <sub>SS</sub>	M6	V <sub>SS</sub>
J7	P2.14 / SCL 0 / WUP15	K7	P2.13 / INT15	L7	P2.12 / INT14	M7	XTAL1
J8	P3.1 / AIN1	K8	P3.0 / AIN0	L8	VBIAS	M8	TST
J9	P3.13 / AIN13 / INT3	K9	P3.4 / AIN4	L9	P3.3 / AIN3	M9	P3.2 / AIN2
J10	P3.12 / AIN12 / INT2	K10	V <sub>DDA</sub>	L10	P3.5 / AIN5	M10	V <sub>SS</sub>
J11	P3.9 / AIN9	K11	V <sub>SSA</sub>	L11	P3.7 / AIN7	M11	V <sub>DD</sub>
J12	P3.8 / AIN8	K12	P3.11 / AIN11	L12	P3.10 / AIN10	M12	P3.6 / AIN6

**Note:** CAN alternate functions not available on STR735F.

3.2.3 STR731F/STR736F (TQFP100)

Figure 4. STR731F/STR736F pin configuration (top view)

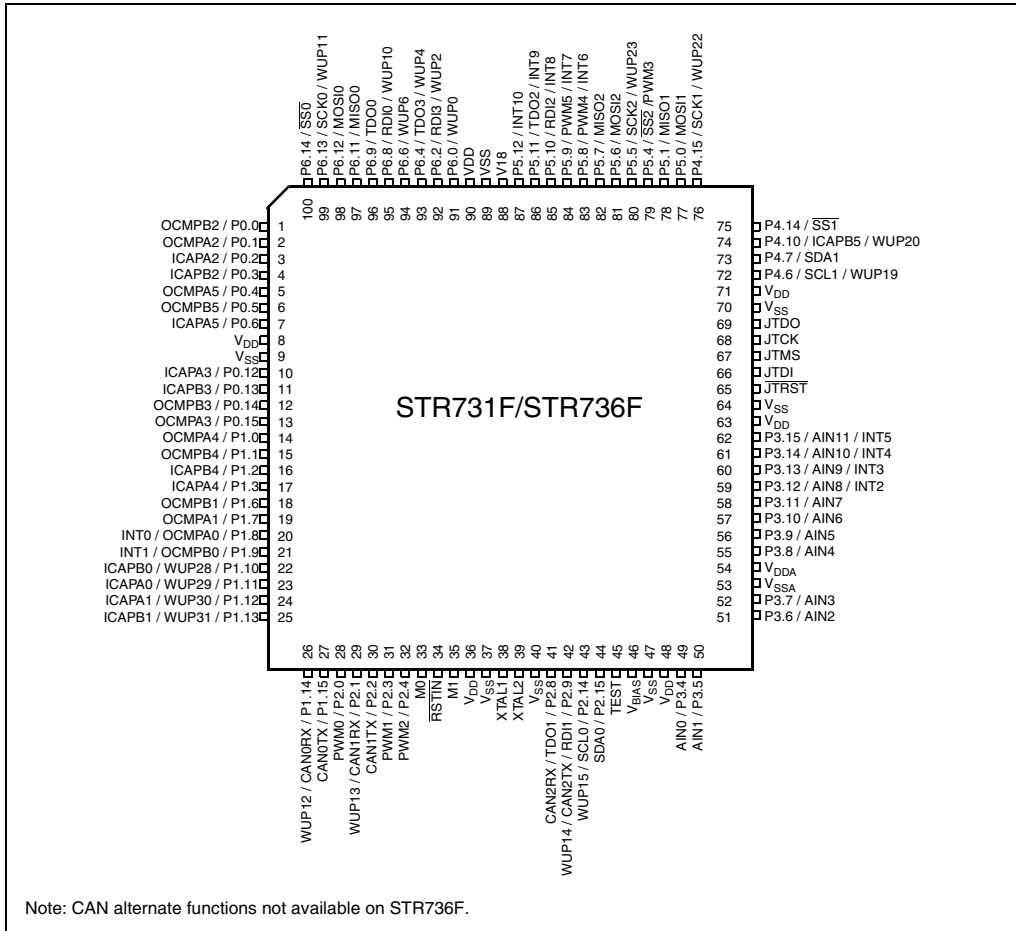

Note: CAN alternate functions not available on STR736F.

**Legend / Abbreviations for Table 4:**

Type: I = input, O = output, S = supply, HiZ= high impedance,

In/Output level:  $T_T$  = TTL 0.8 V / 2 V with input trigger  
 $C_T$  = CMOS 0.3V<sub>DD</sub>/0.7V<sub>DD</sub> with input trigger

Port and control configuration:

Input: pu/pd = with internal 100 k $\Omega$  weak pull-up or pull down

Output: OD = open drain (logic level)  
 PP = push-pull

Interrupts:

INTx = external interrupt line

WUPx = wake-up interrupt line

*The reset state (during and just after the reset) of the I/O ports is input floating (Input tristate TTL mode). To avoid excess power consumption, unused I/O ports must be tied to ground.*

**Table 4. STR73xF pin description**

Pin n°			Pin name	Type	Input			Output			Main function (after reset)	Alternate function
TQFP144	LFBGA144	TQFP100			Input Level	pu/pd	interrupt	Capability	OD	PP		
1	A1	1	P0.0/OCMPB2	I/O	$T_T$			2mA	X	X	Port 0.0	TIM2: output compare B output
2	B2	2	P0.1/OCMPA2	I/O	$T_T$			2mA	X	X	Port 0.1	TIM2: output compare A output
3	C2	3	P0.2/ICAPA2	I/O	$T_T$			2mA	X	X	Port 0.2	TIM2: input capture A input
4	C3	4	P0.3/ICAPB2	I/O	$T_T$			2mA	X	X	Port 0.3	TIM2: input capture B input
5	D1		V <sub>SS</sub>	S							Ground	
6	D2		V <sub>DD</sub>	S							Supply voltage (5 V)	
7	B1	5	P0.4/OCMPA5	I/O	$T_T$			2mA	X	X	Port 0.4	TIM5: output compare A output
8	C1	6	P0.5/OCMPB5	I/O	$T_T$			2mA	X	X	Port 0.5	TIM5: output compare B output
9	D3	7	P0.6/ICAPA5	I/O	$T_T$			2mA	X	X	Port 0.6	TIM5: input capture A input
10	D4		P0.7/ICAPB5	I/O	$T_T$			2mA	X	X	Port 0.7	TIM5: input capture B input
11	E1		P0.8/OCMPA6	I/O	$T_T$			2mA	X	X	Port 0.8	TIM6: output compare A output
12	E2		P0.9/OCMPB6	I/O	$T_T$			2mA	X	X	Port 0.9	TIM6: output compare B output
13	E3		P0.10/OCMPA7	I/O	$T_T$			2mA	X	X	Port 0.10	TIM7: output compare A output
14	E4		P0.11/OCMPB7	I/O	$T_T$			2mA	X	X	Port 0.11	TIM7: output compare B output
15	F1	8	V <sub>DD</sub>	S							Supply voltage (5 V)	
16	G1	9	V <sub>SS</sub>	S							Ground	
17	E5	10	P0.12/ICAPA3	I/O	$T_T$			2mA	X	X	Port 0.12	TIM3: input capture A input
18	F2	11	P0.13/ICAPB3	I/O	$T_T$			2mA	X	X	Port 0.13	TIM3: input capture B input

Table 4. STR73xF pin description

Pin n°			Pin name	Type	Input			Output			Main function (after reset)	Alternate function
TQFP144	LFBGA144	TQFP100			Input Level	pu/pd	interrupt	Capability	OD	PP		
19	F3	12	P0.14/OCMPB3	I/O	T <sub>T</sub>			2mA	X	X	Port 0.14	TIM3: output compare B output
20	F4	13	P0.15/OCMPA3	I/O	T <sub>T</sub>			2mA	X	X	Port 0.15	TIM3: output compare A output
21	F5	14	P1.0/OCMPA4	I/O	T <sub>T</sub>			2mA	X	X	Port 1.0	TIM4: output compare A output
22	F6	15	P1.1/OCMPB4	I/O	T <sub>T</sub>			2mA	X	X	Port 1.1	TIM4: output compare B output
23	G2	16	P1.2/ICAPB4	I/O	T <sub>T</sub>			2mA	X	X	Port 1.2	TIM4: input capture B input
24	G3	17	P1.3/ICAPA4	I/O	T <sub>T</sub>			2mA	X	X	Port 1.3	TIM4: input capture A input
25	G4		V <sub>SS</sub>	S							Ground	
26	H1		V <sub>DD</sub>	S							Supply voltage (5 V)	
27	J1		P1.4	I/O	T <sub>T</sub>			2mA	X	X	Port 1.4	
28	G5		P1.5	I/O	T <sub>T</sub>			2mA	X	X	Port 1.5	
29	K1	18	P1.6/OCMPB1	I/O	T <sub>T</sub>			2mA	X	X	Port 1.6	TIM1: output compare B output
30	L1	19	P1.7/OCMPA1	I/O	T <sub>T</sub>			2mA	X	X	Port 1.7	TIM1: output compare A output
31	H2	20	P1.8/OCMPA0	I/O	T <sub>T</sub>		INT0	2mA	X	X	Port 1.8	TIM0: output compare A output
32	H3	21	P1.9/OCMPB0	I/O	T <sub>T</sub>		INT1	2mA	X	X	Port 1.9	TIM0: output compare B output
33	H4	22	P1.10/ICAPB0	I/O	T <sub>T</sub>		WUP28	2mA	X	X	Port 1.10	TIM0: input capture B input
34	J2	23	P1.11/ICAPA0	I/O	T <sub>T</sub>		WUP29	2mA	X	X	Port 1.11	TIM0: input capture A input
35	J3	24	P1.12/ICAPA1	I/O	T <sub>T</sub>		WUP30	2mA	X	X	Port 1.12	TIM1: input capture A input
36	K2	25	P1.13/ICAPB1	I/O	T <sub>T</sub>		WUP31	2mA	X	X	Port 1.13	TIM1: input capture B input
37	M1	26	P1.14/CAN0RX	I/O	T <sub>T</sub>		WUP12	2mA	X	X	Port 1.14	CAN0: receive data input
38	L2	27	P1.15/CAN0TX	I/O	T <sub>T</sub>			2mA	X	X	Port 1.15	CAN0: transmit data output
39	L3	28	P2.0/PWM0	I/O	T <sub>T</sub>			2mA	X	X	Port 2.0	PWM0: PWM output
40	K3	29	P2.1/CAN1RX	I/O	T <sub>T</sub>		WUP13	2mA	X	X	Port 2.1	CAN1: receive data input
41	M4	30	P2.2/CAN1TX	I/O	T <sub>T</sub>			2mA	X	X	Port 2.2	CAN1: transmit data output
42	L4	31	P2.3/PWM1	I/O	T <sub>T</sub>			2mA	X	X	Port 2.3	PWM1: PWM output
43	M2	32	P2.4/PWM2	I/O	T <sub>T</sub>			2mA	X	X	Port 2.4	PWM2: PWM output
44	M3		P2.5/PWM3	I/O	T <sub>T</sub>			2mA	X	X	Port 2.5	PWM3: PWM output
45	K4		P2.6/PWM4	I/O	T <sub>T</sub>			2mA	X	X	Port 2.6	PWM4: PWM output
46	J4		P2.7/PWM5	I/O	T <sub>T</sub>			2mA	X	X	Port 2.7	PWM5: PWM output
47	M5	33	M0	I	T <sub>T</sub>	pd					BOOT: mode selection 0 input	
48	L5	34	RSTIN	I	C <sub>T</sub>	pu					Reset input	
49	K5	35	M1	I	T <sub>T</sub>	pd					BOOT: mode selection 1 input	

Table 4. STR73xF pin description

Pin n°			Pin name	Type	Input			Output			Main function (after reset)	Alternate function
TQFP144	LFBGA144	TQFP100			Input Level	pu/pd	interrupt	Capability	OD	PP		
50	J5	36	V <sub>DD</sub>	S							Supply voltage (5 V)	
51	M6	37	V <sub>SS</sub>	S							Ground	
52	M7	38	XTAL1	I							Oscillator amplifier circuit input and internal clock generator input.	
53	H5	39	XTAL2	O							Oscillator amplifier circuit output.	
54	L6	40	V <sub>SS</sub>	S							Ground	
55	K6	41	P2.8/TDO1/CAN2RX	I/O	T <sub>T</sub>			2mA	X	X	Port 2.8	UART1: transmit data output CAN2: receive data input (TQFP100 only)
56	J6	42	P2.9/RDI1/CAN2TX	I/O	T <sub>T</sub>		WUP14	2mA	X	X	Port 2.9	UART1: receive data input CAN2: transmit data output (TQFP100 only)
57	H6		P2.10	I/O	T <sub>T</sub>		WUP16	2mA	X	X	Port 2.10	
58	G6		P2.11	I/O	T <sub>T</sub>		WUP17	2mA	X	X	Port 2.11	
59	L7		P2.12	I/O	T <sub>T</sub>		INT14	2mA	X	X	Port 2.12	
60	K7		P2.13	I/O	T <sub>T</sub>		INT15	2mA	X	X	Port 2.13	
61	J7	43	P2.14/SCL0	I/O	T <sub>T</sub>		WUP15	2mA	X	X	Port 2.14	I2C0: serial clock
62	H7	44	P2.15/SDA0	I/O	T <sub>T</sub>			2mA	X	X	Port 2.15	I2C0: serial data
63	M8	45	Test	I		pd					Reserved pin. Must be tied to ground	
64	L8	46	V <sub>BIAS</sub>	S							Internal RC oscillator bias. A 1.3 MΩ external resistor has to be connected to this pin when a 32 kHz RC oscillator frequency is used.	
65	M10	47	V <sub>SS</sub>	S							Ground	
66	M11	48	V <sub>DD</sub>	S							Supply voltage (5 V)	
67	K8		P3.0/AIN0	I/O	T <sub>T</sub>			2mA	X	X	Port 3.0	ADC: analog input 0
68	J8		P3.1/AIN1	I/O	T <sub>T</sub>			2mA	X	X	Port 3.1	ADC: analog input 1
69	M9		P3.2/AIN2	I/O	T <sub>T</sub>			2mA	X	X	Port 3.2	ADC: analog input 2
70	L9		P3.3/AIN3	I/O	T <sub>T</sub>			2mA	X	X	Port 3.3	ADC: analog input 3
71	K9	49	P3.4/AIN4	I/O	T <sub>T</sub>			2mA	X	X	Port 3.4	ADC: analog input 4 (AIN0 in TQFP100)
72	L10	50	P3.5/AIN5	I/O	T <sub>T</sub>			2mA	X	X	Port 3.5	ADC: Analog input 5 (AIN1 in TQFP100)



Table 4. STR73xF pin description

Pin n°			Pin name	Type	Input			Output			Main function (after reset)	Alternate function
TQFP144	LFBGA144	TQFP100			Input Level	pu/pd	interrupt	Capability	OD	PP		
73	M12	51	P3.6/AIN6	I/O	T <sub>T</sub>			2mA	X	X	Port 3.6	ADC: analog input 6 (AIN2 in TQFP100)
74	L11	52	P3.7/AIN7	I/O	T <sub>T</sub>			2mA	X	X	Port 3.7	ADC: analog input 7 (AIN3 in TQFP100)
75	K11	53	V <sub>SSA</sub>	S							Reference ground for A/D converter	
76	K10	54	V <sub>DDA</sub>	S							Reference voltage for A/D converter	
77	J12	55	P3.8/AIN8	I/O	T <sub>T</sub>			2mA	X	X	Port 3.8	ADC: analog input 8 (AIN4 in TQFP100)
78	J11	56	P3.9/AIN9	I/O	T <sub>T</sub>			2mA	X	X	Port 3.9	ADC: analog input 9 (AIN5 in TQFP100)
79	L12	57	P3.10/AIN10	I/O	T <sub>T</sub>			2mA	X	X	Port 3.10	ADC: analog input 10 (AIN6 in TQFP100)
80	K12	58	P3.11/AIN11	I/O	T <sub>T</sub>			2mA	X	X	Port 3.11	ADC: analog input 11 (AIN7 in TQFP100)
81	J10	59	P3.12/AIN12	I/O	T <sub>T</sub>		INT2	2mA	X	X	Port 3.12	ADC: analog input 12 (AIN8 in TQFP100)
82	J9	60	P3.13/AIN13	I/O	T <sub>T</sub>		INT3	2mA	X	X	Port 3.13	ADC: analog input 13 (AIN9 in TQFP100)
83	H12	61	P3.14/AIN14	I/O	T <sub>T</sub>		INT4	2mA	X	X	Port 3.14	ADC: analog input 14 (AIN10 in TQFP100)
84	H11	62	P3.15/AIN15	I/O	T <sub>T</sub>		INT5	2mA	X	X	Port 3.15	ADC: analog input 15 (AIN11 in TQFP100)
85	H10	63	V <sub>DD</sub>	S							Supply voltage (5 V)	
86	H9	64	V <sub>SS</sub>	S							Ground	
87	G12	65	JTRST	I	T <sub>T</sub>	pu						JTAG reset Input
88	F12	66	JTDI	I	T <sub>T</sub>	pu						JTAG data input
89	H8	67	JTMS	I	T <sub>T</sub>	pu						JTAG mode selection Input
90	G11	68	JTCK	I	T <sub>T</sub>	pd						JTAG clock Input
91	G10	69	JTDO	O				4mA				JTAG data output. <b>Note:</b> Reset state = HiZ
92	G9	70	V <sub>SS</sub>	S							Ground	
93	G8	71	V <sub>DD</sub>	S							Supply voltage (5 V)	
94	G7		P4.0/ICAPA7	I/O	T <sub>T</sub>		WUP24	2mA	X	X	Port 4.0	TIM7: input capture A input
95	F11		P4.1/ICAPB7	I/O	T <sub>T</sub>		WUP25	2mA	X	X	Port 4.1	TIM7: input capture B input
96	F10		P4.2/ICAPA8	I/O	T <sub>T</sub>		WUP26	2mA	X	X	Port 4.2	TIM8: input capture A input

Table 4. STR73xF pin description

Pin n°			Pin name	Type	Input			Output			Main function (after reset)	Alternate function
TQFP144	LFBGA144	TQFP100			Input Level	pu/pd	interrupt	Capability	OD	PP		
97	F9		P4.3/ICAPB8	I/O	T <sub>T</sub>		WUP27	2mA	X	X	Port 4.3	TIM8: input capture B input
98	F8		P4.4/CAN2TX	I/O	T <sub>T</sub>			2mA	X	X	Port 4.4	CAN2: transmit data output
99	E12		P4.5/CAN2RX	I/O	T <sub>T</sub>		WUP18	2mA	X	X	Port 4.5	CAN2: receive data input
100	E11	72	P4.6/SCL1	I/O	T <sub>T</sub>		WUP19	2mA	X	X	Port 4.6	I2C1: serial clock
101	C12	73	P4.7/SDA1	I/O	T <sub>T</sub>			2mA	X	X	Port 4.7	I2C1: serial data
102	B12		P4.8/OCMPA8	I/O	T <sub>T</sub>			2mA	X	X	Port 4.8	TIM8: output compare A output
103	E10		P4.9/ICAPB6	I/O	T <sub>T</sub>			2mA	X	X	Port 4.9	TIM6: input capture B input
104	E9	74	P4.10/ICAPA6/ICAPB5	I/O	T <sub>T</sub>		WUP20	2mA	X	X	Port 4.10	TIM6: input capture A input (144-pin pkg only) TIM5: input capture B input (TQFP100 only)
105	D12		P4.11/OCMPB8	I/O	T <sub>T</sub>			2mA	X	X	Port 4.11	TIM8: output compare B output
106	D11		P4.12/ICAPA9	I/O	T <sub>T</sub>		WUP21	2mA	X	X	Port 4.12	TIM9: input capture A input
107	D10		P4.13/ICAPB9	I/O	T <sub>T</sub>			2mA	X	X	Port 4.13	TIM9: input capture B input
108	C11	75	P4.14/ $\overline{SS}$ 1	I/O	T <sub>T</sub>			2mA	X	X	Port 4.14	BSPI1: slave select
109	B11	76	P4.15/SCK1	I/O	T <sub>T</sub>		WUP22	2mA	X	X	Port 4.15	BSPI1: serial clock
110	B10	77	P5.0/MOSI1	I/O	T <sub>T</sub>			2mA	X	X	Port 5.0	BSPI1: master output/slave input
111	C10	78	P5.1/MISO1	I/O	T <sub>T</sub>			2mA	X	X	Port 5.1	BSPI1: master input/Slave output
112	A9		P5.2/OCMPA9	I/O	T <sub>T</sub>			2mA	X	X	Port 5.2	TIM9: output compare A output
113	B9		P5.3/OCMPB9	I/O	T <sub>T</sub>			2mA	X	X	Port 5.3	TIM9: output compare B output
114	C9	79	P5.4/ $\overline{SS}$ 2/PWM3	I/O	T <sub>T</sub>			2mA	X	X	Port 5.4	BSPI2: slave select PWM3: PWM output (TQFP100 only)
115	D9	80	P5.5/SCK2	I/O	T <sub>T</sub>		WUP23	2mA	X	X	Port 5.5	BSPI2: serial clock
116	A11	81	P5.6/MOSI2	I/O	T <sub>T</sub>			2mA	X	X	Port 5.6	BSPI2: master output/slave input
117	A10	82	P5.7/MISO2	I/O	T <sub>T</sub>			2mA	X	X	Port 5.7	BSPI2: master input/slave output
118	A8	83	P5.8/PWM4	I/O	T <sub>T</sub>		INT6	2mA	X	X	Port 5.8	PWM4: PWM output (TQFP100 only)

Table 4. STR73xF pin description

Pin n°			Pin name	Type	Input			Output			Main function (after reset)	Alternate function
TQFP144	LFBGA144	TQFP100			Input Level	pu/pd	interrupt	Capability	OD	PP		
119	B8	84	P5.9/PWM5	I/O	T <sub>T</sub>		INT7	2mA	X	X	Port 5.9	PWM5: PWM output (TQFP100 only)
120	C8	85	P5.10/RDI2	I/O	T <sub>T</sub>		INT8	2mA	X	X	Port 5.10	UART2: receive data input
121	A12	86	P5.11/TDO2	I/O	T <sub>T</sub>		INT9	2mA	X	X	Port 5.11	UART2: transmit data output
122	D8	87	P5.12	I/O	T <sub>T</sub>		INT10	2mA	X	X	Port 5.12	
123	E8		P5.13	I/O	T <sub>T</sub>		INT11	2mA	X	X	Port 5.13	
124	B7		P5.14	I/O	T <sub>T</sub>		INT12	2mA	X	X	Port 5.14	
125	A7		P5.15	I/O	T <sub>T</sub>		INT13	2mA	X	X	Port 5.15	
126	A6	88	V <sub>18</sub>	S								1.8 V decoupling pin: a decoupling capacitor (recommended value: 100 nF) must be connected between this pin and nearest V <sub>SS</sub> pin.
127	C7	89	V <sub>SS</sub>	S								Ground
128	D7	90	V <sub>DD</sub>	S								Supply voltage (5 V)
129	E7	91	P6.0	I/O	T <sub>T</sub>		WUP0	8mA	X	X	Port 6.0	
130	F7		P6.1	I/O	T <sub>T</sub>		WUP1	2mA	X	X	Port 6.1	
131	B6	92	P6.2/RDI3	I/O	T <sub>T</sub>		WUP2	2mA	X	X	Port 6.2	UART3: receive data input
132	C6		P6.3	I/O	T <sub>T</sub>		WUP3	2mA	X	X	Port 6.3	
133	D6	93	P6.4/TDO3	I/O	T <sub>T</sub>		WUP4	2mA	X	X	Port 6.4	UART3: transmit data output
134	E6		P6.5	I/O	T <sub>T</sub>		WUP5	2mA	X	X	Port 6.5	
135	A5	94	P6.6	I/O	T <sub>T</sub>		WUP6	2mA	X	X	Port 6.6	
136	B5		P6.7	I/O	T <sub>T</sub>		WUP7	2mA	X	X	Port 6.7	
137	C5	95	P6.8/RDI0	I/O	T <sub>T</sub>		WUP10	2mA	X	X	Port 6.8	UART0: receive data input
138	A3	96	P6.9/TDO0	I/O	T <sub>T</sub>			2mA	X	X	Port 6.9	UART0: transmit data output
139	A2		P6.10	I/O	T <sub>T</sub>		WUP8	2mA	X	X	Port 6.10	
140	D5	97	P6.11/MISO0	I/O	T <sub>T</sub>			2mA	X	X	Port 6.11	BSPI0: master input/slave output
141	A4	98	P6.12/MOSI0	I/O	T <sub>T</sub>			2mA	X	X	Port 6.12	BSPI0: master output/slave input
142	B4	99	P6.13/SCK0	I/O	T <sub>T</sub>		WUP11	2mA	X	X	Port 6.13	BSPI0: serial clock
143	C4	100	P6.14/ $\overline{SS}$ 0	I/O	T <sub>T</sub>			2mA	X	X	Port 6.14	BSPI0: slave select
144	B3		P6.15	I/O	T <sub>T</sub>		WUP9	2mA	X	X	Port 6.15	

### 3.3 Memory mapping

Figure 5 shows the various memory configurations of the STR73xF system. The system memory map (from 0x0000\_0000 to 0xFFFF\_FFFF) is shown on the left part of the figure, the right part shows maps of the Flash and APB areas. For flexibility the Flash or RAM addresses can be aliased to Block 0 addresses using the remapping feature

Most reserved memory spaces (gray shaded areas in Figure 5) are protected from access by the user code. When an access this memory space is attempted, an ABORT signal is generated. Depending on the type of access, the ARM processor will enter “prefetch abort” state (Exception vector 0x0000\_000C) or “data abort” state (Exception vector 0x0000\_0010). It is up to the application software to manage these abort exceptions.

Figure 5. Memory map

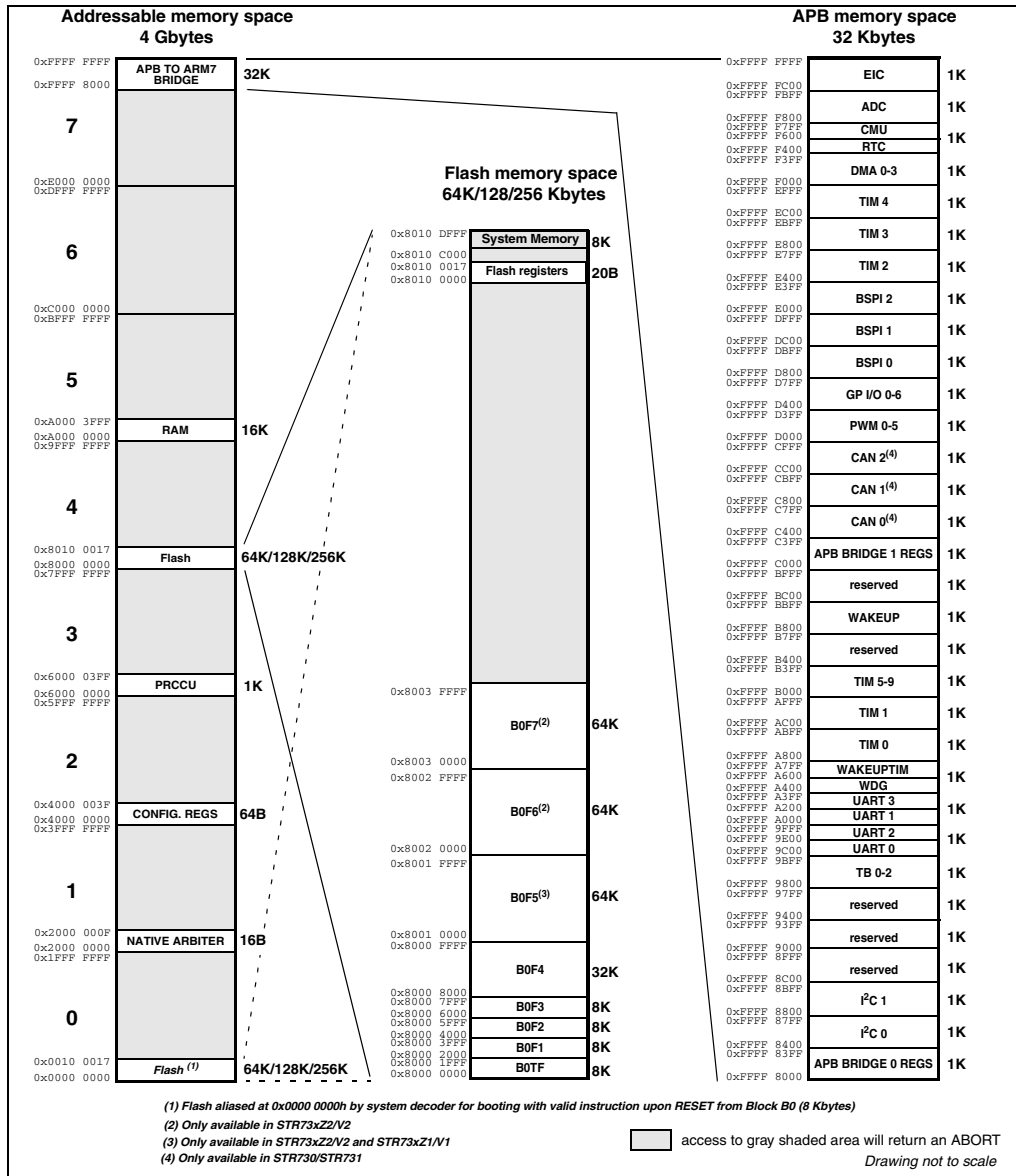

## 4 Electrical parameters

### 4.1 Parameter conditions

Unless otherwise specified, all voltages are referred to  $V_{SS}$ .

#### 4.1.1 Minimum and maximum values

Unless otherwise specified the minimum and maximum values are guaranteed in the worst conditions of ambient temperature, supply voltage and frequencies by tests in production on 100% of the devices with an ambient temperature at  $T_A=25^\circ\text{C}$  and  $T_A=T_{Amax}$  (given by the selected temperature range).

Data based on characterization results, design simulation and/or technology characteristics are indicated in the table footnotes and are not tested in production. Based on characterization, the minimum and maximum values refer to sample tests and represent the mean value plus or minus three times the standard deviation ( $\text{mean}\pm 3\Sigma$ ).

#### 4.1.2 Typical values

Unless otherwise specified, typical data are based on  $T_A=25^\circ\text{C}$  and  $V_{DD}=5\text{V}$ . They are given only as design guidelines and are not tested.

Typical ADC accuracy values are determined by characterization of a batch of samples from a standard diffusion lot over the full temperature range, where 95% of the devices have an error less than or equal to the value indicated ( $\text{mean}\pm 2\Sigma$ ).

#### 4.1.3 Typical curves

Unless otherwise specified, all typical curves are given only as design guidelines and are not tested.

#### 4.1.4 Loading capacitor

The loading conditions used for pin parameter measurement are shown in [Figure 6](#).

#### 4.1.5 Pin input voltage

The input voltage measurement on a pin of the device is described in [Figure 7](#).

**Figure 6. Pin loading conditions**

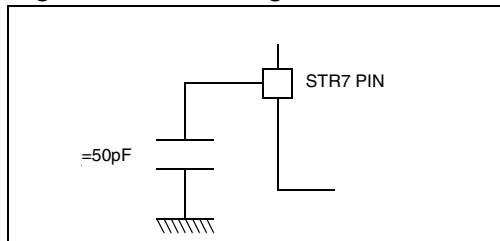

**Figure 7. Pin input voltage**

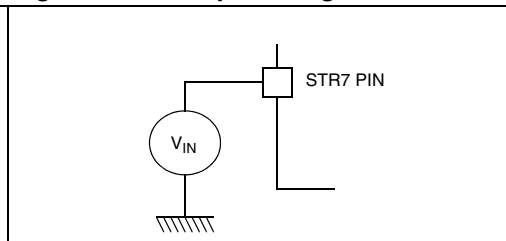

## 4.2 Absolute maximum ratings

Stresses above those listed as “absolute maximum ratings” may cause permanent damage to the device. This is a stress rating only and functional operation of the device under these conditions is not implied. Exposure to maximum rating conditions for extended periods may affect device reliability.

**Table 5. Voltage characteristics**

Symbol	Ratings	Min	Max	Unit
$V_{DD} - V_{SS}$	External 5 V Supply voltage	-0.3	6.0	v
$V_{SSA}$	Reference ground for A/D converter	$V_{SS}$	$V_{SS}$	v
$V_{DDA} - V_{SSA}$	Reference voltage for A/D converter	-0.3	$V_{DD}+0.3$	V
$V_{IN}$	Input voltage on any pin	-0.3	$V_{DD}+0.3$	
$ \Delta V_{DDx} $	Variations between different 5 V power pins	-	0.3	mV
$ V_{SSx} - V_{SS} $	Variations between all the different ground pins	-	0.3	
$V_{ESD(HBM)}$	Electrostatic discharge voltage (Human Body Model)	see : <a href="#">Absolute maximum ratings (electrical sensitivity) on page 36</a>		
$V_{ESD(MM)}$	Electrostatic discharge voltage (Machine Model)			

**Table 6. Current characteristics**

Symbol	Ratings	Max.	Unit
$I_{VDD}$	Total current into $V_{DD}$ power lines (source) <sup>1)</sup>	100	mA
$I_{VSS}$	Total current out of $V_{SS}$ ground lines (sink) <sup>1)</sup>	100	
$I_{IO}$	Output current sunk by any I/O and control pin	10	
	Output current source by any I/O and control pin	10	
$I_{INJ(PIN)}^{2) \& 3)}$	Injected current on any other pin <sup>4) &amp; 5)</sup>	$\pm 10$	
$\Sigma I_{INJ(PIN)}^{2)}$	Total injected current (sum of all I/O and control pins) <sup>4)</sup>	$\pm 75$	

- All 5 V power ( $V_{DD}$ ,  $V_{DDA}$ ) and ground ( $V_{SS}$ ,  $V_{SSA}$ ) pins must always be connected to the external 5 V supply
- $I_{INJ(PIN)}$  must never be exceeded. This is implicitly insured if  $V_{IN}$  maximum is respected. If  $V_{IN}$  maximum cannot be respected, the injection current must be limited externally to the  $I_{INJ(PIN)}$  value. A positive injection is induced by  $V_{IN} > V_{DD}$  while a negative injection is induced by  $V_{IN} < V_{SS}$ .
- Negative injection disturbs the analog performance of the device. See note in [Section 4.3.6: 10-bit ADC characteristics on page 43](#).
- When several inputs are submitted to a current injection, the maximum  $\Sigma I_{INJ(PIN)}$  is the absolute sum of the positive and negative injected currents (instantaneous values). These results are based on characterization with  $\Sigma I_{INJ(PIN)}$  maximum current injection on four I/O port pins of the device.
- In 144-pin devices, only +10 mA on P0.3, P1.13, P3.6 and P4.13 pins (negative injection not allowed).

**Table 7. Thermal characteristics**

Symbol	Ratings	Value	Unit
$T_{STG}$	Storage temperature range	-55 to +150	°C
$T_J$	Maximum junction temperature (see <a href="#">Section 5.2: Thermal characteristics on page 48</a> )		

### 4.3 Operating conditions

Subject to general operating conditions for  $V_{DD}$ , and  $T_A$ .

**Table 8. General operating conditions**

Symbol	Parameter	Conditions	Min	Max	Unit
$f_{MCLK}$	Internal CPU and system clock frequency	Accessing SRAM or Flash (zero wait state Flash access up to 36 MHz)	0	36	MHz
$V_{DD}$	Standard Operating Voltage		4.5	5.5	V
$V_{DDA}$	Operating analog reference voltage with respect to ground		4.5	$V_{DD}+0.1$	V
$T_A$	Ambient temperature range	6 partnumber suffix 7 partnumber suffix	-40 -40	85 105	°C

**Table 9. Operating conditions at power-up / power-down**

Symbol	Parameter	Conditions	Min	Typ	Max	Unit
$t_{VDD}$	$V_{DD}$ rise time rate	Subject to general operating conditions for $T_A$ .	-	20	-	ms/V



### 4.3.1 Supply current characteristics

The current consumption is measured as described in [Figure 6](#) and [Figure 7](#).

#### Total current consumption

The MCU is placed under the following conditions:

- All I/O pins in input mode with a static value at  $V_{DD}$  or  $V_{SS}$  (no load)
- All peripherals are disabled except if explicitly mentioned.

Subject to general operating conditions for  $V_{DD}$ , and  $T_A$ .

**Table 10. Total current consumption**

Symbol	Parameter	Conditions	Typ <sup>1)</sup>	Max <sup>2)</sup>	Unit
$I_{DD}$	RUN mode <sup>3)</sup>	Formula, $f_{MCLK}$ in MHz, RAM execution	$7 + 1.9 f_{MCLK}$		mA
		$f_{MCLK} = 36$ MHz, RAM execution	76		mA
		$f_{MCLK} = 36$ MHz, Flash execution	86		mA
	WFI mode	$f_{OSC} = 4$ MHz, $f_{MCLK} = f_{OSC}/16 = 250$ kHz Main voltage regulator ON, LP voltage regulator = 2 mA, RTC and WDG on, other modules off.	6.7	8	mA
	LPWFI mode	$f_{RC} =$ high frequency (CMU_RCCTL= 0x8), $f_{MCLK} = f_{RC}/16$ , LP voltage regulator = 2 mA, other modules off.	220	350	$\mu$ A
	STOP mode	$f_{OSC} = 4$ MHz, RC oscillator on $f_{RC} =$ high frequency (CMU_RCCTL= 0x0) LP voltage regulator = 6 mA, RTC and WUT ON, other modules off. Internal wake-up possible.	500	700	$\mu$ A
		$f_{RC} =$ high frequency (CMU_RCCTL= 0xF), LP voltage regulator = 2mA. WUT ON, other modules off. Internal wake-up possible.	150	220	
LP voltage regulator = 2 mA, WIU on, Other modules off, external wake-up.		50	140		
HALT mode	LP voltage regulator = 2 mA.	50	140	$\mu$ A	

1. Typical data are based on  $T_A=25^\circ\text{C}$ ,  $V_{DD}=5\text{V}$
2. Data based on characterization results, tested in production at  $V_{DD}$  max. and  $T_A = 25^\circ\text{C}$ .
3. I/O in static configuration (not toggling). RUN mode is almost **independent of temperature**. On the contrary RUN mode current is **highly dependent on the application**. The  $I_{DDRUN}$  value can be significantly reduced by the application in the following ways: switch-off unused peripherals (default), reduce peripheral frequency through internal prescaler, fetch the most frequently-used functions from RAM and use low power mode when possible.

Figure 8. STOP  $I_{DD}$  vs.  $V_{DD}$

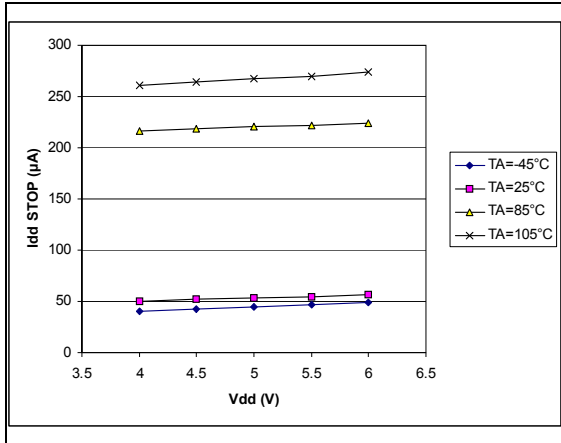

Figure 9. HALT  $I_{DD}$  vs.  $V_{DD}$

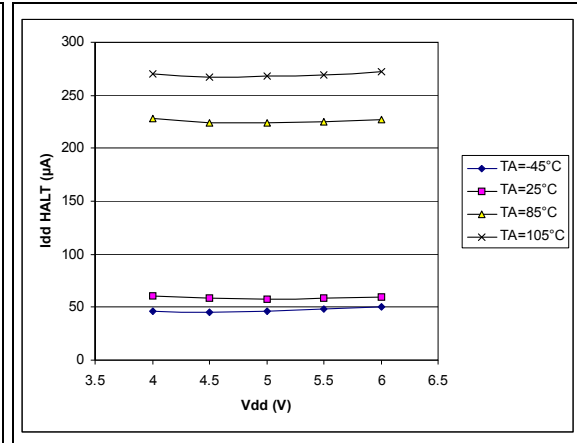

Figure 10. WFI  $I_{DD}$  vs.  $V_{DD}$

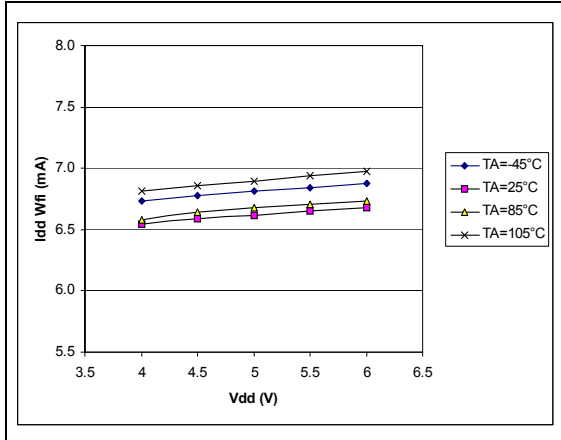
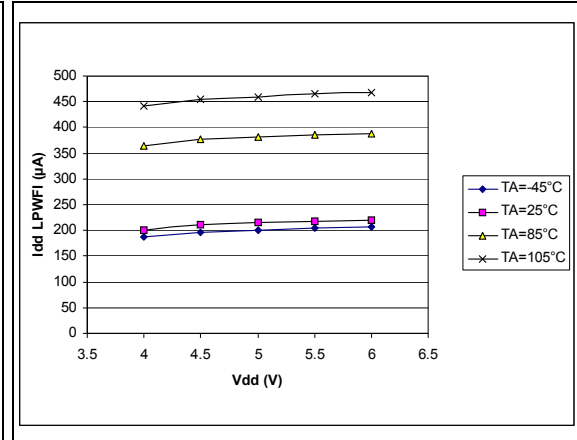

Figure 11. LPWFI  $I_{DD}$  vs.  $V_{DD}$



### Typical application current consumption

**Table 11. Typical consumption in Run mode at 25°C and 85°C**

Conditions		f <sub>MCLK</sub> (MHz)	f <sub>ADC</sub> (MHz)	Typical I <sub>DD</sub> (mA)
V <sub>DD</sub> = 5.5 V, RC oscillator off, PLL on, RTC enabled, 1 Timer (TIM) running, and ADC running in scan mode.	Code executing in RAM	10	10	20
		20		29
		36	9	42
	Code executing in Flash	10	10	22
		20		32
		36	9	48

**Table 12. Typical consumption in Run and low power modes at 25°C**

Mode	Conditions	f <sub>MCLK</sub>	Typical I <sub>DD</sub>
RUN	All peripherals on, RAM execution	36 MHz	76 mA
		24 MHz	56 mA
WFI	Main voltage regulator on, Flash on, EIC on, WIU on, GPIOs on.	36 MHz	33 mA
		24 MHz	31 mA
SLOW	PLL off, main voltage regulator on	4 MHz	11 mA
	CLOCK2/16, main voltage regulator on	250 kHz	8 mA
	CLOCK2/16, main voltage regulator off	250 kHz	3 mA
	RC oscillator running in low frequency, main crystal oscillator off, main voltage regulator off	29 kHz	2.5 mA
LPWFI	CLOCK2/16, main voltage regulator off, LP voltage regulator = 2 mA, Flash in power down mode.	250 kHz	528 μA
STOP	Main voltage regulator off, RTC on, RC oscillator off, LP voltage regulator = 6 mA	-	378 μA
	Main voltage regulator off, RTC off, RC oscillator off, LP voltage regulator = 6 mA	-	83 μA
	Main voltage regulator off, RTC off, RC oscillator off, LP voltage regulator = 4 mA	-	64 μA
	Main voltage regulator off, RTC off, RC oscillator off, LP voltage regulator = 2 mA	-	44 μA
HALT	RTC off, LP voltage regulator = 2 mA	-	44 μA

## On-chip peripherals

Table 13. Peripheral current consumption at  $T_A = 25^\circ\text{C}$ 

Symbol	Parameter	Conditions	Typ	Unit
$I_{DD(RC)}$	RC (backup oscillator) supply current	High frequency	120	$\mu\text{A}$
		Low frequency	60	$\mu\text{A}$
$I_{DD(TIM)}$	TIM timer supply current <sup>1)</sup>	$f_{MCLK}=36\text{ MHz}$	350	$\mu\text{A}$
$I_{DD(BSPI)}$	BSPI supply current <sup>1)</sup>		1.1	mA
$I_{DD(UART)}$	UART supply current <sup>1)</sup>		850	$\mu\text{A}$
$I_{DD(I2C)}$	I2C supply current <sup>1)</sup>		430	$\mu\text{A}$
$I_{DD(ADC)}$	ADC supply current when converting <sup>2)</sup>		5	mA
$I_{DD(EIC)}$	EIC supply current		2.88	mA
$I_{DD(CAN)}$	CAN supply current <sup>1)</sup>		2.95	mA
$I_{DD(GPIO)}$	GPIO supply current		150	$\mu\text{A}$
$I_{DD(TB)}$	TB supply current		250	$\mu\text{A}$
$I_{DD(PWM)}$	PWM supply current		240	$\mu\text{A}$
$I_{DD(RTC)}$	RTC supply current		370	$\mu\text{A}$
$I_{DD(DMA)}$	DMA supply current		2.5	mA
$I_{DD(ARB)}$	Native arbiter supply current		180	$\mu\text{A}$
$I_{DD(AHB)}$	AHB arbiter supply current		570	$\mu\text{A}$
$I_{DD(WUT)}$	WUT supply current		300	$\mu\text{A}$
$I_{DD(WIU)}$	WIU supply current		460	$\mu\text{A}$

1. Data based on a differential  $I_{DD}$  measurement between the on-chip peripheral when kept under reset, not clocked and the on-chip peripheral when clocked and not kept under reset. This measurement does not include the pad toggling consumption.
2. Data based on a differential  $I_{DD}$  measurement between reset configuration and continuous A/D conversions.

### 4.3.2 Clock and timing characteristics

#### Crystal / ceramic resonator oscillator

The STR73xF can operate with a crystal oscillator or resonator clock source. [Figure 12](#) describes a simple model of the internal oscillator driver as well as example of connection for an oscillator or a resonator.

**Figure 12. Crystal oscillator and resonator**

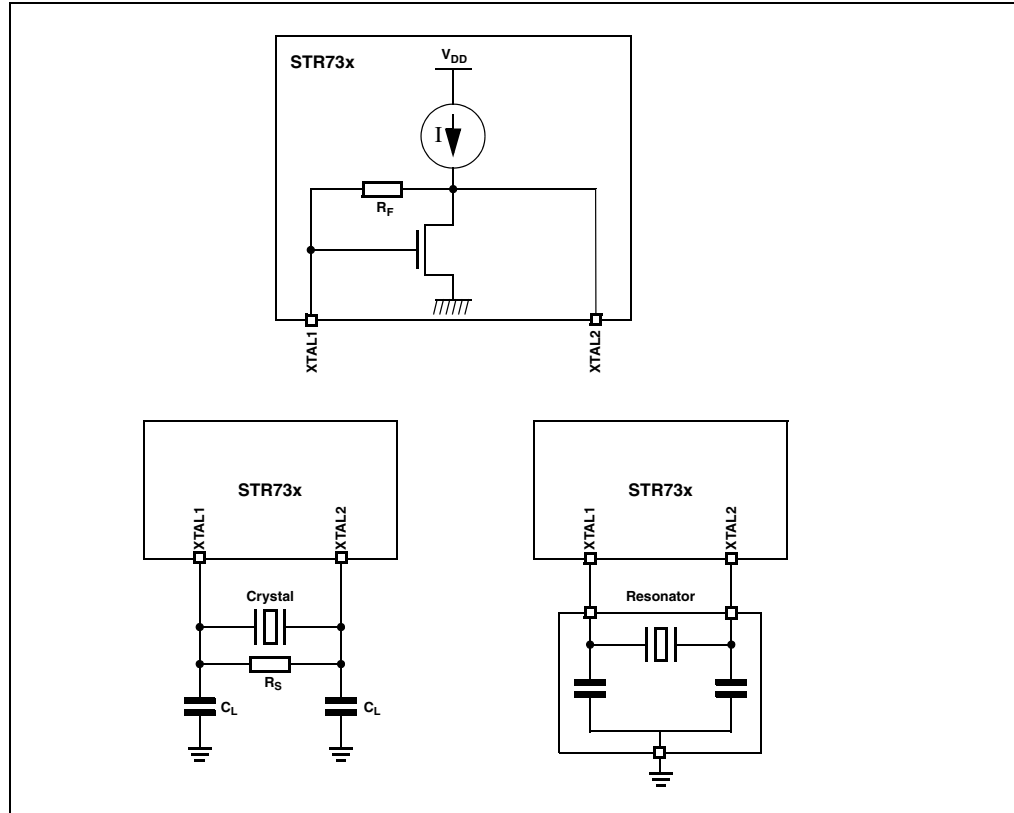

- Note:
- 1 XTAL2 must not be used to directly drive external circuits.
  - 2 For test or boot purpose, XTAL2 can be used as an high impedance input pin to provide an external clock to the device. XTAL1 should be grounded, and XTAL2 connected to a wave signal generator providing a 0 to VDD signal. Directly driving XTAL2 may results in deteriorated jitter and duty cycle.

**Main oscillator characteristics**

$V_{DD} = 5\text{ V} \pm 10\%$ ,  $T_A = -40^\circ\text{ C}$  to  $T_{Amax}$ , unless otherwise specified.

**Table 14. Main oscillator characteristics**

Symbol	Parameter	Conditions	Value			Unit
			Min	Typ	Max	
$f_{OSC}$	Oscillator frequency		4		8	MHz
$g_m$	Oscillator transconductance		1.5		4.2	mA/V
$V_{OSC}^{1)}$	Oscillation amplitude	$f_{OSC} = 4\text{ MHz}$ , $T_A = 25^\circ\text{ C}$	-	2.4	-	V
		$f_{OSC} = 8\text{ MHz}$ , $T_A = 25^\circ\text{ C}$		1.-		
$V_{AV}^{1)}$	Oscillator operating point	Sine wave middle, $T_A = 25^\circ\text{ C}$	-	0.77	-	v
$t_{STUP}^{1)}$	Oscillator start-up time	External crystal, $V_{DD} = 5.5\text{ V}$ , $f_{OSC} = 4\text{ MHz}$ , $T_A = -40^\circ\text{ C}$	-	-	12	ms
		External crystal, $V_{DD} = 5.0\text{ V}$ , $f_{OSC} = 4\text{ MHz}$ , $T_A = 25^\circ\text{ C}$	-	5.5	-	ms
		External crystal, $V_{DD} = 5.5\text{ V}$ , $f_{OSC} = 6\text{ MHz}$ , $T_A = -40^\circ\text{ C}$	-	-	8	ms
		External crystal, $V_{DD} = 5.0\text{ V}$ , $f_{OSC} = 6\text{ MHz}$ , $T_A = 25^\circ\text{ C}$	-	3.3	-	ms
		External crystal, $V_{DD} = 5.5\text{ V}$ , $f_{OSC} = 8\text{ MHz}$ , $T_A = -40^\circ\text{ C}$	-	-	7	ms
		External crystal, $V_{DD} = 5.0\text{ V}$ , $f_{OSC} = 8\text{ MHz}$ , $T_A = 25^\circ\text{ C}$	-	2.7	-	ms

Table 14. Main oscillator characteristics (continued)

Symbol	Parameter	Conditions	Value			Unit	
			Min	Typ	Max		
$R_F^{1)}$	Feedback resistor	$f_{OSC} = 4 \text{ MHz}$ $C_p^{2)}) = 10 \text{ pF}$	$C_1^{3)}) = C_2^{4)}) = 10 \text{ pF}$	150	555	-	$\Omega$
			$C_1 = C_2 = 20 \text{ pF}$	490	1035	-	
			$C_1 = C_2 = 30 \text{ pF}$	490	1030	-	
			$C_1 = C_2 = 40 \text{ pF}$	380	850	-	
		$f_{OSC} = 5 \text{ MHz}$ $C_p = 10 \text{ pF}$	$C_1 = C_2 = 10 \text{ pF}$	160	470	-	
			$C_1 = C_2 = 20 \text{ pF}$	415	800	-	
			$C_1 = C_2 = 30 \text{ pF}$	340	735	-	
			$C_1 = C_2 = 40 \text{ pF}$	260	580	-	
		$f_{OSC} = 6 \text{ MHz}$ $C_p = 10 \text{ pF}$	$C_1 = C_2 = 10 \text{ pF}$	160	415	-	
			$C_1 = C_2 = 20 \text{ pF}$	325	640	-	
			$C_1 = C_2 = 30 \text{ pF}$	250	550	-	
			$C_1 = C_2 = 40 \text{ pF}$	180	420	-	
		$f_{OSC} = 7 \text{ MHz}$ $C_p = 10 \text{ pF}$	$C_1 = C_2 = 10 \text{ pF}$	160	375	-	
			$C_1 = C_2 = 20 \text{ pF}$	260	525	-	
			$C_1 = C_2 = 30 \text{ pF}$	185	420	-	
			$C_1 = C_2 = 40 \text{ pF}$	135	315	-	
		$f_{OSC} = 8 \text{ MHz}$ $C_p = 10 \text{ pF}$	$C_1 = C_2 = 10 \text{ pF}$	155	340	-	
			$C_1 = C_2 = 20 \text{ pF}$	210	435	-	
			$C_1 = C_2 = 30 \text{ pF}$	145	335	-	
			$C_1 = C_2 = 40 \text{ pF}$	100	245	-	

1. Min and max values are guaranteed by characterization, not tested in production.
2.  $C_p$  represents the total capacitance between XTAL1 and XTAL2, including the shunt capacitance of the external quartz crystal as well as the total board parasitic cross-capacitance between XTAL1 track and XTAL2 track.
3.  $C_1$  represents the total capacitance between XTAL1 and ground, including the external capacitance tied to XTAL1 pin ( $C_L$ ) as well as the total parasitic capacitance between XTAL1 track and ground (this includes application board track capacitance to ground and device pin capacitance).
4.  $C_2$  represents the total capacitance between XTAL2 and ground, including the external capacitance tied to XTAL2 pin ( $C_L$ ) as well as the total parasitic capacitance between XTAL2 track and ground (this includes application board track capacitance to ground and device pin capacitance).

**RC/backup oscillator characteristics**

$V_{DD} = 5V \pm 10\%$ ,  $T_A = -40^\circ\text{C}$  to  $T_{Amax}$ , unless otherwise specified.

**Table 15. RC oscillator characteristics**

Symbol	Parameter	Conditions	Value			Unit
			Min	Typ	Max	
$f_{RC}$	RC frequency	High frequency mode <sup>1)</sup>		2.35		MHz
		Low frequency mode <sup>1)</sup>		29		kHz
$f_{RCHF}$	RC high frequency	CMU_RCCTL = 0x0	3			MHz
		CMU_RCCTL = 0xF			2.3	MHz
$f_{RCLF}$	RC low frequency	CMU_RCCTL = 0x0	35			kHz
		CMU_RCCTL = 0xF			30	kHz
$f_{RCHFS}^{2)}$	RC high frequency stability	Fixed CMU_RCCTL			10	%
$f_{RCLFS}^{2)}$	RC low frequency stability	Fixed CMU_RCCTL			23	%
$t_{RCSTUP}$	RC start-up time	Stable $V_{DD}$ , $f_{RC} = 2.35$ MHz, $T_A = 25^\circ\text{C}$		2.35		$\mu\text{s}$

1) CMU\_RCCTL = 0x8

2) RC frequency shift versus average value (%)



**PLL electrical characteristics**

$V_{DD} = 5\text{ V} \pm 10\%$ ,  $T_A = -40^\circ\text{ C}$  to  $T_{Amax}$ , unless otherwise specified

**Table 16. PLL characteristics**

Symbol	Parameter	Conditions	Value			Unit
			Min	Typ	Max	
$f_{PLLIN}^{(1)}$	PLL reference clock	FREF_RANGE = '0' FREF_RANGE = '1'	1.5 3.0		3.0 5.0	MHz
$f_{PLLOUT}$	PLL output clock	MX = "00" MX = "01" MX = "10" MX = "11"	20 x $f_{PLLIN}$ 12 x $f_{PLLIN}$ 28 x $f_{PLLIN}$ 16 x $f_{PLLIN}$			MHz
$f_{MCLK}$	System clock	DX = 1..7	$f_{PLLOUT}/DX$		36	MHz
$f_{FREE}^{(2)}$	PLL free running frequency	FREF_RANGE = '0', MX0 = '1' FREF_RANGE = '0', MX0 = '0' FREF_RANGE = '1', MX0 = '1' FREF_RANGE = '1', MX0 = '0'		120 240 240 480		kHz
$t_{LOCK}^{(3)}$	PLL lock time	Stable oscillator ( $f_{PLLIN} = 4\text{ MHz}$ ), stable $V_{DD}$		100	300	$\mu\text{s}$
$\Delta t_{PKJIT}$	PLL jitter (pk to pk)	$f_{PLLIN} = 4\text{ MHz}$ (pulse generator)			1.5	ns

1.  $f_{PLLIN}$  is obtained from  $f_{OSC}$  directly or through an optional divider by 2.

2. Typical data are based on  $T_A=25^\circ\text{C}$ ,  $V_{DD}=5\text{V}$

3. Max value is guaranteed by characterization, not tested in production.

**Table 17. Low-power mode wake-up timing**

Symbol	Parameter	Conditions	Typ	Unit
$t_{WUHALT}$	Wake-up from HALT mode		200	$\mu\text{s}$
$t_{WUSTOP}$	Wake-up from STOP mode	RC high frequency in STOP mode	180	$\mu\text{s}$
		RC low frequency in STOP mode	234	$\mu\text{s}$
$t_{WULPWF1}^{1)}$	Wake-up from LPWFI mode	Main voltage regulator on RC oscillator off $f_{OSC} = 4\text{ MHz}$ , $f_{MCLK} = f_{OSC}/16$ RAM or FLASH execution	27	$\mu\text{s}$
		Main voltage regulator on RC oscillator = high frequency Flash execution	46	$\mu\text{s}$
		Main voltage regulator on RC oscillator = low frequency Flash execution	3.6	ms

1. Flash memory programmed to enter Power Down mode during LPWFI.

### 4.3.3 Memory characteristics

#### Flash memory

**Table 18. Flash memory characteristics**

Symbol	Parameter	Test Conditions	Value			Unit
			Min	Typ	Max <sup>1)</sup>	
$t_{WP}$	Word program (32-bit)			35	80	$\mu$ s
$t_{DWP}$	Double word program(64-bit)			64	150	$\mu$ s
$t_{BP64}$	Bank program (64 K)	Double word program		0.5	1.25	s
$t_{BP128}$	Bank program (128 K)	Double word program		1	2.5	s
$t_{BP256}$	Bank program (256 K)	Double word program		2	4.9	s
$t_{SE8}$	Sector erase (8 K)	Not preprogrammed Preprogrammed <sup>2)</sup>		0.6 0.5	0.9 0.8	s
$t_{SE32}$	Sector erase (32 K)	Not preprogrammed Preprogrammed <sup>2)</sup>		1.1 0.8	2 1.8	s
$t_{SE64}$	Sector erase (64 K)	Not preprogrammed preprogrammed <sup>2)</sup>		1.7 1.3	3.7 3.3	s
$t_{RPD}$ <sup>3)</sup>	Recovery from power-down				20	$\mu$ s
$t_{PSL}$ <sup>3)</sup>	Program suspend latency				10	$\mu$ s
$t_{ESL}$ <sup>3)</sup>	Erase suspend latency				30	$\mu$ s
$t_{ESR}$ <sup>3)</sup>	Erase suspend rate	Min. time from erase resume to next erase suspend		20	20	ms
$t_{SP}$ <sup>3)</sup>	Set protection			40	170	$\mu$ s
$t_{FPW}$ <sup>3)</sup>	First word program			1		ms
$N_{END}$	Endurance		10			kcycles
$t_{RET}$	Data retention	$T_A = 85^\circ \text{C}$	20			Years

1.  $T_A = -45^\circ \text{C}$  after 0 cycles, Guaranteed by characterization, not tested in production.
2. All bits programmed to 0.
3. Guaranteed by design, not tested in production.

#### 4.3.4 EMC characteristics

Susceptibility tests are performed on a sample basis during product characterization.

##### Functional EMS (electromagnetic susceptibility)

Based on a simple running application on the product (toggling 2 LEDs through I/O ports), the product is stressed by two electromagnetic events until a failure occurs (indicated by the LEDs).

- **ESD:** Electrostatic discharge (positive and negative) is applied on all pins of the device until a functional disturbance occurs. This test conforms with the IEC 1000-4-2 standard.
- **FTB:** A burst of fast transient voltage (positive and negative) is applied to  $V_{DD}$  and  $V_{SS}$  through a 100 pF capacitor, until a functional disturbance occurs. This test conforms with the IEC 1000-4-4 standard.

A device reset allows normal operations to be resumed. The test results are given in the table below based on the EMS levels and classes defined in application note AN1709.

##### Designing hardened software to avoid noise problems

EMC characterization and optimization are performed at component level with a typical application environment and simplified MCU software. It should be noted that good EMC performance is highly dependent on the user application and the software in particular.

Therefore it is recommended that the user applies EMC software optimization and prequalification tests in relation with the EMC level requested for his application.

##### Software recommendations:

The software flowchart must include the management of runaway conditions such as:

- Corrupted program counter
- Unexpected reset
- Critical data corruption (control registers...)

##### Prequalification trials:

Most of the common failures (unexpected reset and program counter corruption) can be reproduced by manually forcing a low state on the RESET pin or the oscillator pins for 1 second.

To complete these trials, ESD stress can be applied directly on the device, over the range of specification values. When unexpected behavior is detected, the software can be hardened to prevent unrecoverable errors occurring (see application note AN1015).

**Table 19. EMS data**

Symbol	Parameter	Conditions	Level/Class
$V_{FESD}$	Voltage limits to be applied on any I/O pin to induce a functional disturbance	$V_{DD}=5\text{ V}$ , $T_A=+25^\circ\text{ C}$ , $f_{MCLK}=36\text{ MHz}$ conforms to IEC 1000-4-2	4A
$V_{EFTB}$	Fast transient voltage burst limits to be applied through 100 pF on $V_{DD}$ and $V_{SS}$ pins to induce a functional disturbance	$V_{DD}=5\text{ V}$ , $T_A=+25^\circ\text{ C}$ , $f_{MCLK}=36\text{ MHz}$ conforms to IEC 1000-4-4	4A

### Electromagnetic interference (EMI)

Based on a simple application running on the product (toggling 2 LEDs through the I/O ports), the product is monitored in terms of emission. This emission test is in line with the norm SAE J 1752/3 which specifies the board and the loading of each pin.

**Table 20. EMI data**

Symbol	Parameter	Conditions	Monitored frequency band	Max vs. [f <sub>OSC4M</sub> /f <sub>MCLK</sub> ]		Unit
				6/36 MHz	8/8 MHz	
S <sub>EMI</sub>	Peak level	V <sub>DD</sub> =5.0V, T <sub>A</sub> =+25°C, All packages	0.1 MHz to 30 MHz	23	30	dBμV
			30 MHz to 130 MHz	37	34	
			130 MHz to 1 GHz	20	7	
			SAE EMI Level	4	3.5	-

### Absolute maximum ratings (electrical sensitivity)

Based on three different tests (ESD, LU and DLU) using specific measurement methods, the product is stressed in order to determine its performance in terms of electrical sensitivity. For more details, refer to the application note AN1181.

### Electrostatic discharge (ESD)

Electrostatic discharges (a positive then a negative pulse separated by 1 second) are applied to the pins of each sample according to each pin combination. The sample size depends on the number of supply pins in the device (3 parts\*(n+1) supply pin). Two models can be simulated: human body model and machine model. This test conforms to the JESD22-A114A/A115A standard.

**Table 21. ESD Absolute Maximum ratings**

Symbol	Ratings	Conditions	Maximum value <sup>1)</sup>	Unit
V <sub>ESD(HBM)</sub>	Electrostatic discharge voltage (human body model)	T <sub>A</sub> =+25° C	2000	V
V <sub>ESD(MM)</sub>	Electrostatic discharge voltage (machine model)		200	
V <sub>ESD(CDM)</sub>	Electrostatic discharge voltage (charge device model)		750 on corner pins, 500 on others	

**Notes:**

1. Data based on characterization results, not tested in production.

### Static and dynamic latch-up

- **LU:** 3 complementary static tests are required on 10 parts to assess the latch-up performance. A supply overvoltage (applied to each power supply pin) and a current injection (applied to each input, output and configurable I/O pin) are performed on each

sample. This test conforms to the EIA/JESD 78 IC latch-up standard. For more details, refer to the application note AN1181.

- **DLU:** Electrostatic discharges (one positive then one negative test) are applied to each pin of 3 samples when the micro is running to assess the latch-up performance in dynamic mode. Power supplies are set to the typical values, the oscillator is connected as near as possible to the pins of the micro and the component is put in reset mode. This test conforms to the IEC1000-4-2 and SAEJ1752/3 standards. For more details, refer to the application note AN1181.

**Table 22. Electrical sensitivities**

Symbol	Parameter	Conditions	Class <sup>1)</sup>
LU	Static latch-up class	$T_A=+25^{\circ}\text{C}$	A
		$T_A=+85^{\circ}\text{C}$	A
		$T_A=+105^{\circ}\text{C}$	A
DLU	Dynamic latch-up class	$V_{DD}= 5.5\text{ V}$ , $f_{OSC4M} = 4\text{ MHz}$ , $f_{MCLK} = 32\text{ MHz}$ , $T_A = +25^{\circ}\text{C}$	A

1. Class description: A Class is an STMicroelectronics internal specification. All its limits are higher than the JEDEC specifications, that means when a device belongs to Class A it exceeds the JEDEC standard. B Class strictly covers all the JEDEC criteria (international standard).

### 4.3.5 I/O port pin characteristics

#### General characteristics

Subject to general operating conditions for  $V_{DD}$  and  $T_A$  unless otherwise specified.

**Table 23. I/O static characteristics**

Symbol	Parameter	Conditions	Min	Typ	Max	Unit
$V_{IL}$	Input low level voltage <sup>1)</sup>	TTL ports			0.8	V
$V_{IH}$	Input high level voltage <sup>1)</sup>		2.0			
$I_{INJ(PIN)}$	Injected current on any I/O pin				±10	mA
$\Sigma I_{INJ(PIN)}$ <sup>2)</sup>	Total injected current (sum of all I/O and control pins)				±75	mA
$I_{kg}$	Input leakage current <sup>3)</sup>	$V_{SS} \leq V_{IN} \leq V_{DD}$			±1	µA
$I_S$	Static current consumption <sup>4)</sup>	Floating input mode		200		µA
$R_{PU}$	Weak pull-up equivalent resistor <sup>5)</sup>	$V_{IN} = V_{SS}$	55	120	220	kΩ
$R_{PD}$	Weak pull-down equivalent resistor <sup>5)</sup>	$V_{IN} = V_{DD}$	55	120	220	kΩ
$C_{IO}$	I/O pin capacitance			5		pF

1. Data based on characterization results, not tested in production.
2. When the current limitation is not possible, the  $V_{IN}$  absolute maximum rating must be respected, otherwise refer to  $I_{INJ(PIN)}$  specification. A positive injection is induced by  $V_{IN} > V_{33}$  while a negative injection is induced by  $V_{IN} < V_{SS}$ . Refer to [Section 4.2 on page 22](#) for more details.
3. Leakage could be higher than max. if negative current is injected on adjacent pins.
4. Configuration not recommended, all unused pins must be kept at a fixed voltage: using the output mode of the I/O for example or an external pull-up or pull-down resistor. Data based on design simulation and/or technology characteristics, not tested in production.
6. The  $R_{PU}$  pull-up and  $R_{PD}$  pull-down equivalent resistor are based on a resistive transistor (corresponding  $I_{PU}$  and  $I_{PD}$  current characteristics described in [Figure 19](#)).

**Output driving current**

Subject to general operating conditions for  $V_{DD}$  and  $T_A$  unless otherwise specified.

**Table 24. Output driving current**

I/O Type	Symbol	Parameter	Conditions	Min	Max	Unit
Standard	$V_{OL}^{1)}$	Output low level voltage for an I/O pin when 8 pins are sunk at same time	$I_{IO}=+2\text{ mA}$		0.4	V
	$V_{OH}^{2)}$	Output high level voltage for an I/O pin when 4 pins are sourced at same time	$I_{IO}=-2\text{ mA}$	$V_{DD}-0.8$		
Med. Current (JTDO)	$V_{OL}^{1)}$	Output low level voltage for an I/O pin	$I_{IO}=+6\text{ mA}$		0.4	
	$V_{OH}^{2)}$	Output high level voltage for an I/O pin	$I_{IO}=-6\text{ mA}$	$V_{DD}-0.8$		
High Current P6.0	$V_{OL}^{1)}$	Output low level voltage for an I/O pin	$I_{IO}=+8\text{ mA}$		0.4	
	$V_{OH}^{2)}$	Output high level voltage for an I/O pin	$I_{IO}=-8\text{ mA}$	$V_{DD}-0.8$		

1. The  $I_{IO}$  current sunk must always respect the absolute maximum rating specified in [Table 6](#) and the sum of  $I_{IO}$  (I/O ports and control pins) must not exceed  $I_{VSS}$ .
2. The  $I_{IO}$  current sourced must always respect the absolute maximum rating specified in [Table 6](#) and the sum of  $I_{IO}$  (I/O ports and control pins) must not exceed  $I_{VDD}$ .

**Figure 13.  $V_{OH}$  standard ports vs  $I_{OH}$  @  $V_{DD}$  5V** **Figure 14.  $V_{OL}$  standard ports vs  $I_{OL}$  @  $V_{DD}$  5V**  
 $T_A$  -45° C

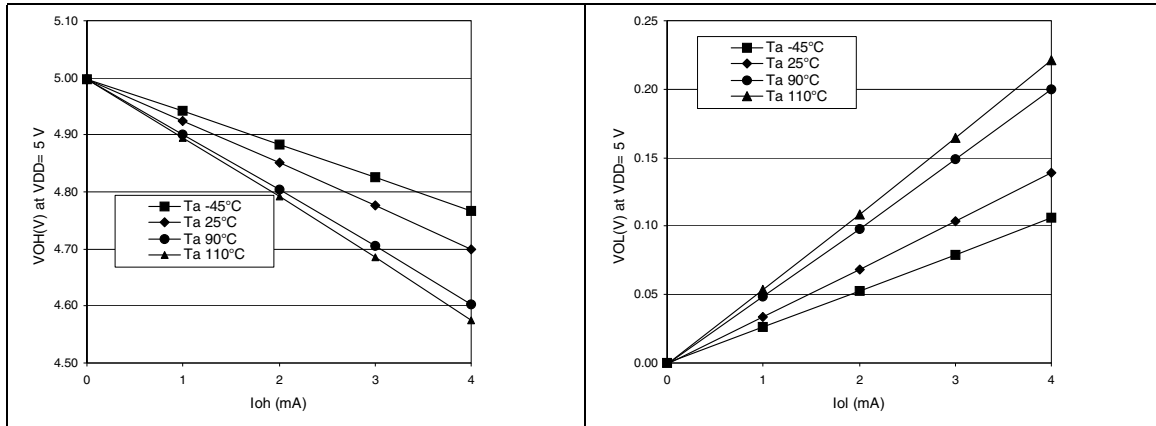

Figure 15.  $V_{OH}$  JTDO pin vs  $I_{OL}$  @  $V_{DD}$  5 V

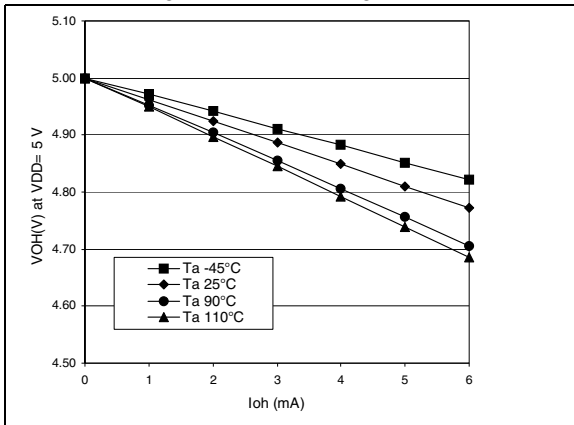

Figure 16.  $V_{OL}$  JTDO pin vs  $I_{OL}$  @  $V_{DD}$  5 V

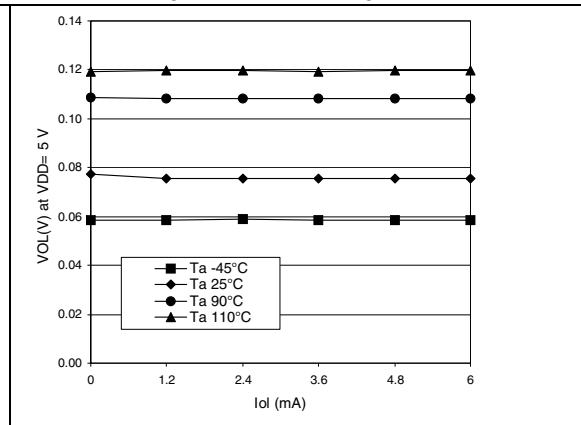

Figure 17.  $V_{OH}$  P6.0 pin vs  $I_{OL}$  @  $V_{DD}$  5 V

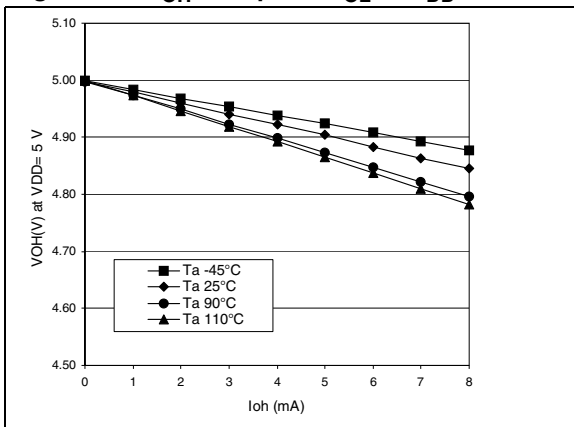
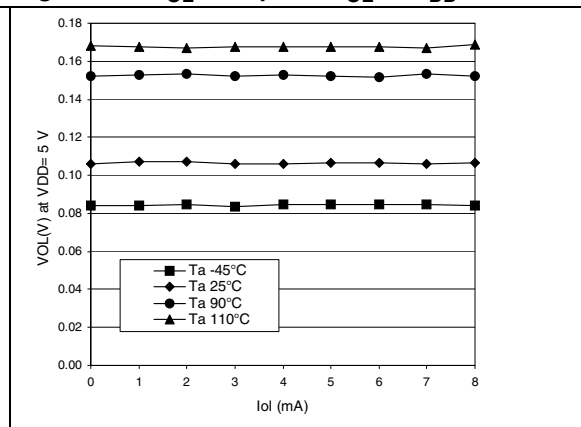

Figure 18.  $V_{OL}$  P6.0 pin vs  $I_{OL}$  @  $V_{DD}$  5 V





## NRSTIN pin

The NRSTIN pin input driver is CMOS. A permanent pull-up is present which is the same as  $R_{PU}$  (see : [General characteristics on page 38](#))

Subject to general operating conditions for  $V_{DD}$  and  $T_A$  unless otherwise specified.

**Table 25. Reset pin characteristics**

Symbol	Parameter	Conditions	Min	Typ <sup>1)</sup>	Max	Unit
$V_{IL(NRSTIN)}$	NRSTIN Input low level voltage <sup>1)</sup>				$0.3 V_{DD}$	V
$V_{IH(NRSTIN)}$	NRSTIN Input high level voltage <sup>1)</sup>		$0.7 V_{DD}$			
$V_{hys(NRSTIN)}$	NRSTIN Schmitt trigger voltage hysteresis <sup>2)</sup>			800		mV
$V_{F(RSTINn)}$	NRSTIN Input filtered pulse <sup>3)</sup>				500	ns
$V_{NF(RSTINn)}$	NRSTIN Input not filtered pulse <sup>3)</sup>		2			$\mu$ s
$V_{RP(RSTINn)}$	NRSTIN removal after Power-up <sup>3)</sup>		100			$\mu$ s

1. Data based on characterization results, not tested in production.

2. Hysteresis voltage between Schmitt trigger switching levels.

3. Data guaranteed by design, not tested in production.

**Figure 19. Recommended NRSTIN pin protection<sup>1)</sup>**

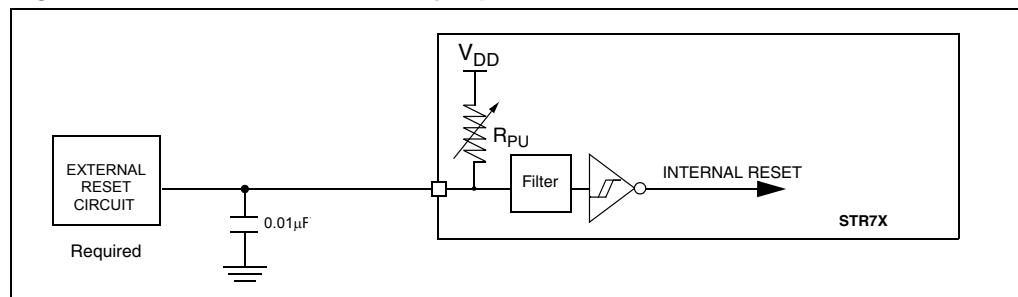

1. The  $R_{PU}$  pull-up equivalent resistor is based on a resistive transistor.

2. The reset network protects the device against parasitic resets.

3. The user must ensure that the level on the NRSTIN pin can go below the  $V_{IL(NRSTIN)}$  max. level specified in [Table 25](#). Otherwise the reset will not be taken into account internally.

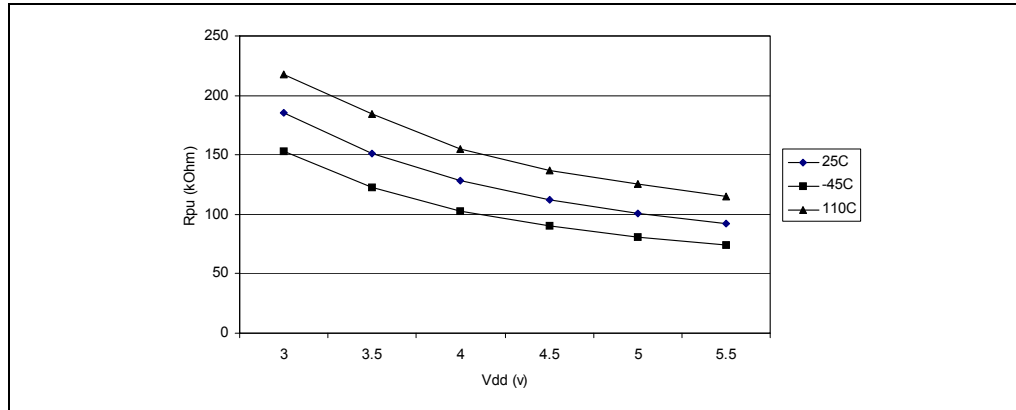
Figure 20. NRSTIN R<sub>PU</sub> vs. V<sub>DD</sub>

### 4.3.6 10-bit ADC characteristics

Subject to general operating conditions for  $V_{DDA}$ ,  $f_{MCLK}$ , and  $T_A$  unless otherwise specified.

**Table 26. ADC characteristics**

Symbol	Parameter	Conditions	Min	Typ <sup>1)</sup>	Max	Unit
$f_{ADC}$			0.4		10	MHz
$V_{AIN}$	Conversion voltage range <sup>2)</sup>		$V_{SSA}$		$V_{DDA}$	V
$I_{lkg}$	Negative input leakage current on analog pins	$V_{IN} < V_{SS}$ , $ I_{IN}  < 400 \mu A$ on adjacent analog pin		5	6	$\mu A$
$C_{ADC}$	Internal sample and hold capacitor				3.5	pF
$t_{CAL}$ <sup>2)</sup>	Calibration time	$f_{ADC} = 10 \text{ MHz}$	580.2			$\mu s$
			5802			$1/f_{ADC}$
$t_S$ <sup>3)</sup>	Sampling time	$f_{ADC} = 10 \text{ MHz}$	1		14	$\mu s$
$t_{CONV}$	Total conversion time (including sampling time)	$f_{ADC} = 10 \text{ MHz}$	3			$\mu s$
			30 (10 for sampling +20 for successive approximation)			$1/f_{ADC}$
$I_{ADC}$	Running mode	Normal mode			5	mA
	Power-down mode				1	$\mu A$

1. Unless otherwise specified, typical data are based on  $T_A=25^\circ C$  and  $V_{DDA}-V_{SS}=5.0V$ . They are given only as design guidelines and are not tested.
2. Calibration is recommended once after each power-up.
3. During the sample time the input capacitance  $C_{AIN}$  (6.8 max) can be charged/discharged by the external source. The internal resistance of the analog source must allow the capacitance to reach its final voltage level within  $t_S$ . After the end of the sample time  $t_S$ , changes of the analog input voltage have no effect on the conversion result. Values for the sample clock  $t_S$  depend on programming.

**Table 27. ADC accuracy with  $f_{MCLK} = 20 \text{ MHz}$ ,  $f_{ADC} = 10 \text{ MHz}$ ,  $R_{AIN} < 10 \text{ k}\Omega$ ,  $R_{AIN}$ ,  $V_{DDA} = 5 \text{ V}$ . This assumes that the ADC is calibrated<sup>2)</sup>**

Symbol	Parameter	Conditions	Typ	Max	Unit
$ E_T $	Total unadjusted error <sup>1)</sup>		1.0	2.0	LSB
$ E_O $	Offset error <sup>1)</sup>		0.15	1.0	
$ E_G $	Gain error <sup>1)</sup>		0.97	1.1	
$ E_D $	Differential linearity error <sup>1)</sup>		0.7	1.0	
$ E_L $	Integral linearity error <sup>1)</sup>		0.76	1.5	

1. ADC accuracy vs. negative injection current: Injecting negative current on any of the standard (non-robust) analog input pins should be avoided as this significantly reduces the accuracy of the conversion being performed on another analog input. It is recommended to add a Schottky diode (pin to ground) to standard analog pins which may potentially inject negative current. The effect of negative injection current on robust pins is specified in [Section 4.3.5](#). Any positive injection current within the limits specified for  $I_{INJ(PIN)}$  and  $\Sigma I_{INJ(PIN)}$  in [Section 4.3.5](#) does not affect the ADC accuracy.
2. Calibration is needed once after each power-up.

**Figure 21. ADC accuracy characteristics**

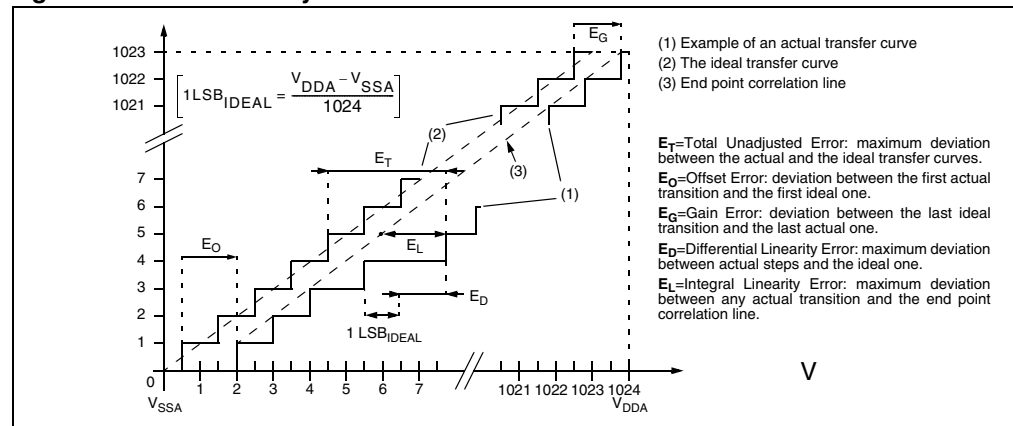

**Figure 22. Typical application with ADC**

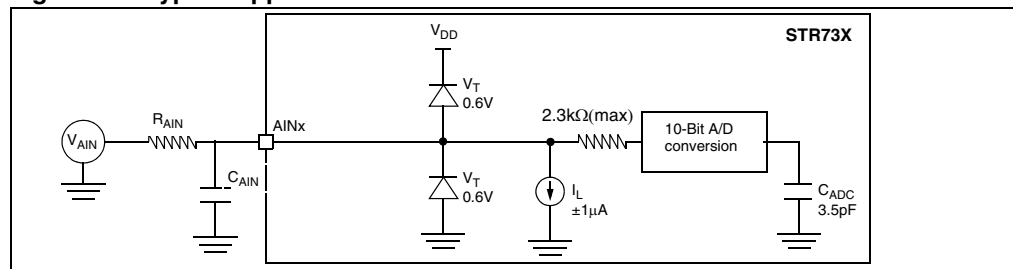

### Analog power supply and reference pins

The  $V_{DDA}$  and  $V_{SSA}$  pins are the analog power supply of the A/D converter cell. They act as the high and low reference voltages for the conversion.

Separation of the digital and analog power pins allow board designers to improve A/D performance. Conversion accuracy can be impacted by voltage drops and noise in the event of heavily loaded or badly decoupled power supply lines (see: [General PCB design guidelines](#)).

### General PCB design guidelines

To obtain best results, some general design and layout rules should be followed when designing the application PCB to shield the noise-sensitive, analog physical interface from noise-generating CMOS logic signals.

- Use separate digital and analog planes. The analog ground plane should be connected to the digital ground plane via a single point on the PCB.
- Filter power to the analog power planes. It is recommended to connect capacitors, with good high frequency characteristics, between the power and ground lines, placing 0.1  $\mu\text{F}$  and optionally, if needed 10 pF capacitors as close as possible to the STR7 power supply pins and a 1 to 10  $\mu\text{F}$  capacitor close to the power source (see [Figure 23](#)).
- The analog and digital power supplies should be connected in a star network. Do not use a resistor, as  $V_{DDA}$  is used as a reference voltage by the A/D converter and any resistance would cause a voltage drop and a loss of accuracy.
- Properly place components and route the signal traces on the PCB to shield the analog inputs. Analog signals paths should run over the analog ground plane and be as short as possible. Isolate analog signals from digital signals that may switch while the analog inputs are being sampled by the A/D converter. Do not toggle digital outputs near the A/D input being converted.

### Software filtering of spurious conversion results

For EMC performance reasons, it is recommended to filter A/D conversion outliers using software filtering techniques.

**Figure 23. Power supply filtering**

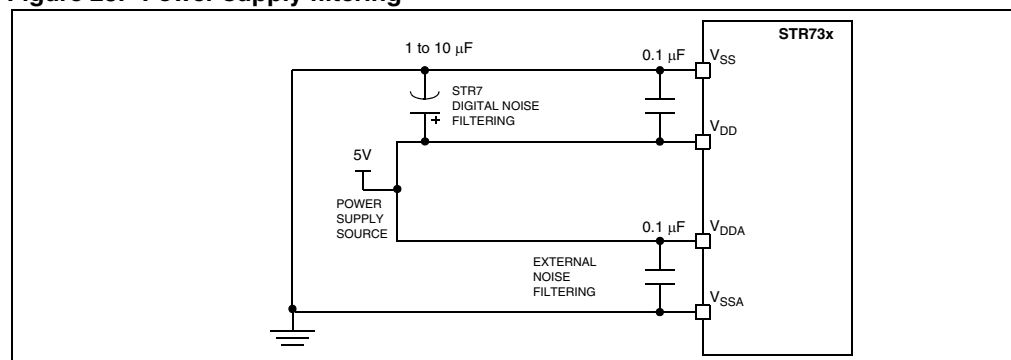

## 5 Package characteristics

### 5.1 Package mechanical data

Figure 24. 100-pin thin quad flat package

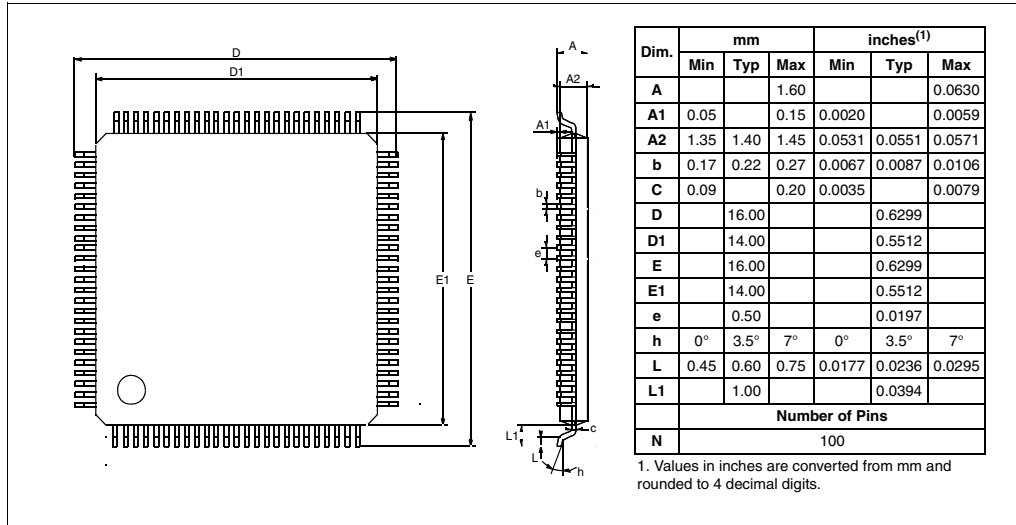

Figure 25. 144-pin thin quad flat package

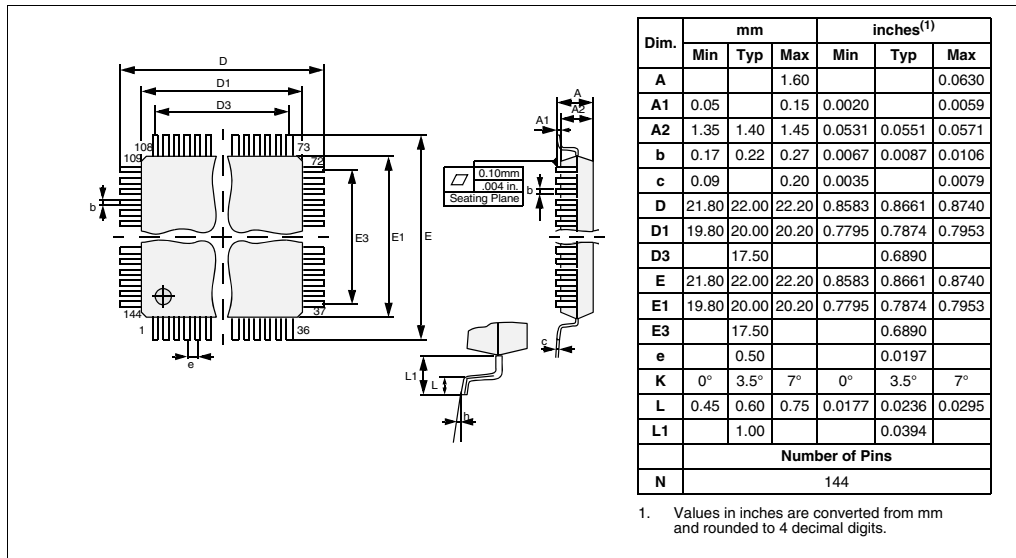

Figure 26. 144-ball low profile fine pitch ball grid array package

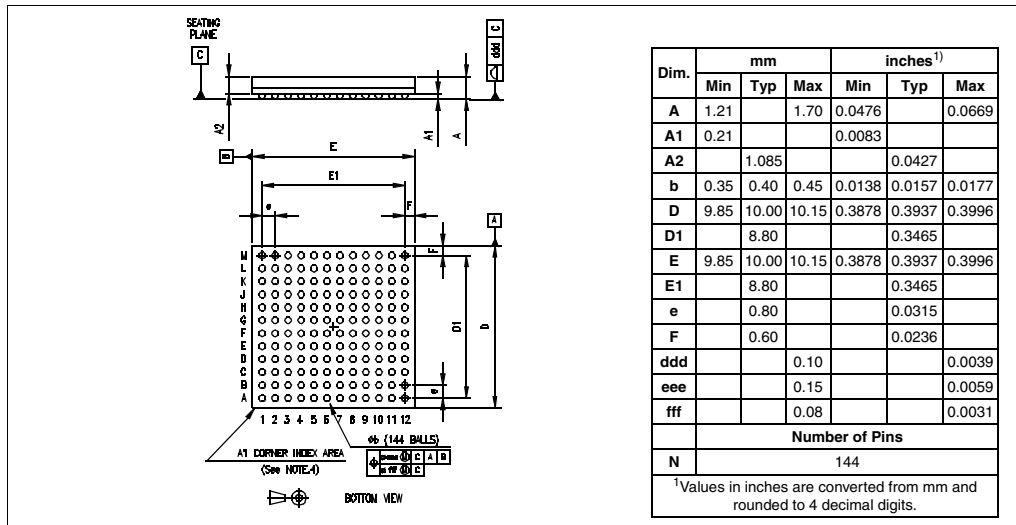
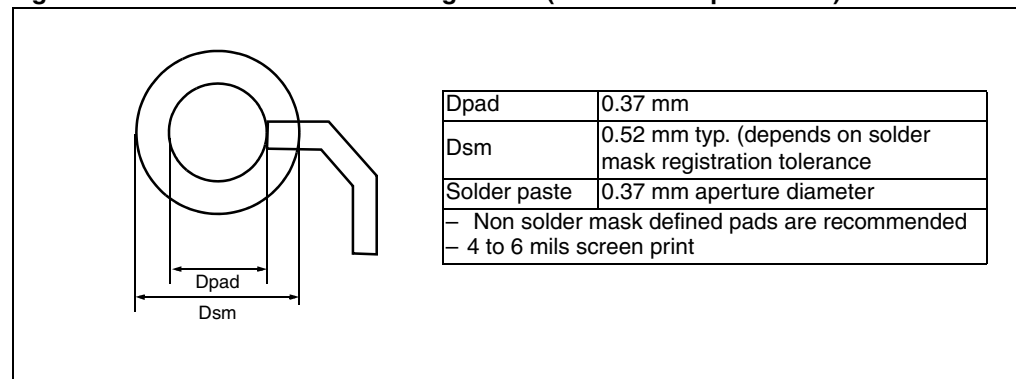

Figure 27. Recommended PCB design rules (0.80/0.75mm pitch BGA)



## 5.2 Thermal characteristics

The average chip-junction temperature,  $T_J$ , in degrees Celsius, may be calculated using the following equation:

$$T_J = T_A + (P_D \times \Theta_{JA}) \quad (1)$$

Where:

- $T_A$  is the ambient temperature in °C,
- $\Theta_{JA}$  is the package junction-to-ambient thermal resistance, in °C/W,
- $P_D$  is the sum of  $P_{INT}$  and  $P_{I/O}$  ( $P_D = P_{INT} + P_{I/O}$ ),
- $P_{INT}$  is the product of  $I_{DD}$  and  $V_{DD}$ , expressed in Watts. This is the chip internal power,
- $P_{I/O}$  represents the power dissipation on input and output pins; user determined.

Most of the time for the applications  $P_{I/O} < P_{INT}$  and may be neglected. On the other hand,  $P_{I/O}$  may be significant if the device is configured to drive continuously external modules and/or memories.

An approximate relationship between  $P_D$  and  $T_J$  (if  $P_{I/O}$  is neglected) is given by:

$$P_D = K / (T_J + 273^\circ\text{C}) \quad (2)$$

Therefore (solving equations 1 and 2):

$$K = P_D \times (T_A + 273^\circ\text{C}) + \Theta_{JA} \times P_D^2 \quad (3)$$

Where:

- $K$  is a constant for the particular part, which may be determined from equation (3) by measuring  $P_D$  (at equilibrium) for a known  $T_A$ . Using this value of  $K$ , the values of  $P_D$  and  $T_J$  may be obtained by solving equations (1) and (2) iteratively for any value of  $T_A$

**Table 28. Thermal characteristics**

Symbol	Description	Package	Value (typical)	Unit
$\Theta_{JA}$	Thermal resistance junction-ambient	LFPGA144	50	°C/W
		TQFP144	40	
		TQFP100	40	



## 6 Order codes

Table 29. Order codes

Partnumber	Flash Kbytes	Package	RAM Kbytes	TIM timers	6x PWM module	CAN periph	A/D chan.	Wake-up lines	I/O ports	Temp. range				
STR730FZ1T6	128	TQFP144 20x20	16	10	1	3	16	32	112	-40 to +85°C				
STR730FZ2T6	256										LFBGA144 10x10	6	0	12
STR730FZ1H6	128	TQFP144 20x20				3								
STR730FZ2H6	256										LFBGA144 10x10	6	0	12
STR735FZ1T6	128	TQFP144 20x20				6								
STR735FZ2T6	256										LFBGA144 10x10	6	0	12
STR735FZ1H6	128	TQFP144 20x20		6	0	12	18	72						
STR735FZ2H6	256								LFBGA144 10x10		6	0	12	18
STR731FV0T6	64	TQFP100 14x14		6	0	12	18	72						
STR731FV1T6	128								TQFP100 14x14		6	0	12	18
STR731FV2T6	256	TQFP100 14x14		6	0	12	18	72						
STR736FV0T6	64								TQFP100 14x14		6	0	12	18
STR736FV1T6	128	TQFP100 14x14	6	0	12	18	72							
STR736FV2T6	256							TQFP100 14x14	6	0	12	18	72	
STR730FZ1T7	128	TQFP144 20x20	16	10	1	3	16							32
STR730FZ2T7	256							LFBGA144 10x10	6	0	12	18	72	
STR730FZ1H7	128	TQFP144 20x20				6								
STR730FZ2H7	256							LFBGA144 10x10	6	0	12	18	72	
STR735FZ1T7	128	TQFP144 20x20				6								
STR735FZ2T7	256							LFBGA144 10x10	6	0	12	18	72	
STR735FZ1H7	128	TQFP144 20x20		6	0	12	18							72
STR735FZ2H7	256							LFBGA144 10x10	6	0	12	18	72	
STR731FV0T7	64	TQFP100 14x14		6	0	12	18							72
STR731FV1T7	128							TQFP100 14x14	6	0	12	18	72	
STR731FV2T7	256	TQFP100 14x14		6	0	12	18							72
STR736FV0T7	64							TQFP100 14x14	6	0	12	18	72	
STR736FV1T7	128	TQFP100 14x14	6	0	12	18	72							
STR736FV2T7	256							TQFP100 14x14	6	0	12	18	72	

## 7 Known limitations

### 7.1 Low power wait for interrupt mode

When the STR73x device is put in Low Power Wait For Interrupt mode (LPWFI), the Flash goes into low power mode or power down mode, depending on the setting of the PWD bit in the Flash Control Register 0 (default is '0', Low Power mode). This default mode can create excessive voltage conditions on the transistor gates and may affect the long term behavior of the Low Power mode circuitry.

#### Workaround

There is no workaround. If Low Power Wait For Interrupt mode is used, it is strongly suggested to configure the Flash to enter power down mode (bit PWD = '1').

### 7.2 PLL free running mode at high temperature

When the STR73x device is operated and an ambient temperature ( $T_A$ ) of more than 55° C and the main system clock ( $f_{MCLK}$ ) is sourced by the PLL in free running mode, the device may not work properly.

#### Workaround

At high temperature (more than 55° C), it is recommended to use the internal RC oscillator as a backup clock source rather than the PLL free running mode.

## 8 Revision history

Table 30. Document revision history

Date	Revision	Description of changes
19-Sep-2005	1	First release
02-Nov-2005	2	Removed Table 8 power consumption in LP modes Updated PLL frequency in <a href="#">Section 1.1</a> and <a href="#">Table 12</a>
08-Mar-2006	3	<a href="#">Section 3.4: Preliminary power consumption data</a> updated <a href="#">Section 3.5: DC electrical characteristics</a> updated <a href="#">Section 7: Known limitations</a> added
04-Jun-2006	4	<a href="#">Section 4: Electrical parameters</a> updated <a href="#">Section 7: Known limitations</a> updated Added temperature range -40°C to 85°C in <a href="#">Section 6: Order codes</a>
19-Jun-2006	5	Changed Flash data retention to 20 years at 85°C in <a href="#">Table 18 on page 34</a> .
08-Sep-2006	6	Changed <a href="#">Table 24: Output driving current on page 39</a> Added <a href="#">Figure 14: VOL standard ports vs IOL @ VDD 5 V</a> thru <a href="#">Figure 18: VOL P6.0 pin vs IOL @ VDD 5 V on page 40</a> . Added <a href="#">Figure 20: NRSTIN RPU vs. VDD</a>
08-Jun-2008	7	Inch values rounded to 4 decimal digits in <a href="#">Section 5.1: Package mechanical data</a> Modified BSPI speed in <a href="#">Section 2.1: On-chip peripherals</a>

**Please Read Carefully:**

Information in this document is provided solely in connection with ST products. STMicroelectronics NV and its subsidiaries ("ST") reserve the right to make changes, corrections, modifications or improvements, to this document, and the products and services described herein at any time, without notice.

All ST products are sold pursuant to ST's terms and conditions of sale.

Purchasers are solely responsible for the choice, selection and use of the ST products and services described herein, and ST assumes no liability whatsoever relating to the choice, selection or use of the ST products and services described herein.

No license, express or implied, by estoppel or otherwise, to any intellectual property rights is granted under this document. If any part of this document refers to any third party products or services it shall not be deemed a license grant by ST for the use of such third party products or services, or any intellectual property contained therein or considered as a warranty covering the use in any manner whatsoever of such third party products or services or any intellectual property contained therein.

**UNLESS OTHERWISE SET FORTH IN ST'S TERMS AND CONDITIONS OF SALE ST DISCLAIMS ANY EXPRESS OR IMPLIED WARRANTY WITH RESPECT TO THE USE AND/OR SALE OF ST PRODUCTS INCLUDING WITHOUT LIMITATION IMPLIED WARRANTIES OF MERCHANTABILITY, FITNESS FOR A PARTICULAR PURPOSE (AND THEIR EQUIVALENTS UNDER THE LAWS OF ANY JURISDICTION), OR INFRINGEMENT OF ANY PATENT, COPYRIGHT OR OTHER INTELLECTUAL PROPERTY RIGHT.**

**UNLESS EXPRESSLY APPROVED IN WRITING BY AN AUTHORIZED ST REPRESENTATIVE, ST PRODUCTS ARE NOT RECOMMENDED, AUTHORIZED OR WARRANTED FOR USE IN MILITARY, AIR CRAFT, SPACE, LIFE SAVING, OR LIFE SUSTAINING APPLICATIONS, NOR IN PRODUCTS OR SYSTEMS WHERE FAILURE OR MALFUNCTION MAY RESULT IN PERSONAL INJURY, DEATH, OR SEVERE PROPERTY OR ENVIRONMENTAL DAMAGE. ST PRODUCTS WHICH ARE NOT SPECIFIED AS "AUTOMOTIVE GRADE" MAY ONLY BE USED IN AUTOMOTIVE APPLICATIONS AT USER'S OWN RISK.**

Resale of ST products with provisions different from the statements and/or technical features set forth in this document shall immediately void any warranty granted by ST for the ST product or service described herein and shall not create or extend in any manner whatsoever, any liability of ST.

ST and the ST logo are trademarks or registered trademarks of ST in various countries.

Information in this document supersedes and replaces all information previously supplied.

The ST logo is a registered trademark of STMicroelectronics. All other names are the property of their respective owners.

© 2008 STMicroelectronics - All rights reserved

STMicroelectronics group of companies

Australia - Belgium - Brazil - Canada - China - Czech Republic - Finland - France - Germany - Hong Kong - India - Israel - Italy - Japan - Malaysia - Malta - Morocco - Singapore - Spain - Sweden - Switzerland - United Kingdom - United States of America

[www.st.com](http://www.st.com)