

Waterproof optical connectors with built-in SC/LC-Duplex

SW20 Series

Waterproof

1 or 2 pos.

Bayonet lock

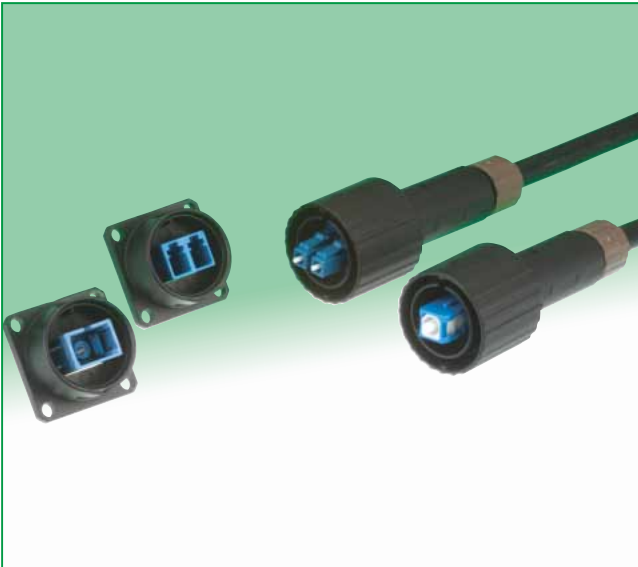

One action lock/unlock mechanism (Patented)

The schematic illustration of internal mechanism. (in case of LC type)

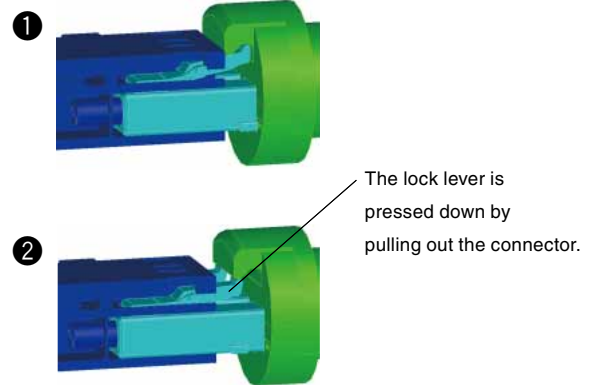

Fig.1

■Features

1. Waterproof bayonet lock + standard SC/LC connector

This connector combines a standard optical connector (SC/LC) and optical adaptor(SC/LC), and is covered with a waterproof shell. The bayonet locking mechanism provides a single-action mating/unmating between the receptacle mounted on the chassis and the plug.

2. Designed for harsh outdoor environments

Connector has passed a 1,000 hour salt spray test as well as the IP67 waterproof test when mated or with protective caps in place.

3. Common housing for SW20-SC and SW20-LC

The waterproof outer shell can be used for both the SW20-SC and SW20-LC. This feature simplifies procedures for mounting, mating and unmating.

4. Standard SC/LC connectors for testing

Any cord with a standard optical connector can be used for operation tests during assembly or installation, when water resistance is unnecessary. No special cord is needed.

5. Easy on-site maintenance

In the event of damage, the end face can be repaired by replacing the internal standard patch cord. This eliminates the need for replacement of the entire receptacle. (Fig.2)

During maintenance and repair

Only the harness parts are replaced.

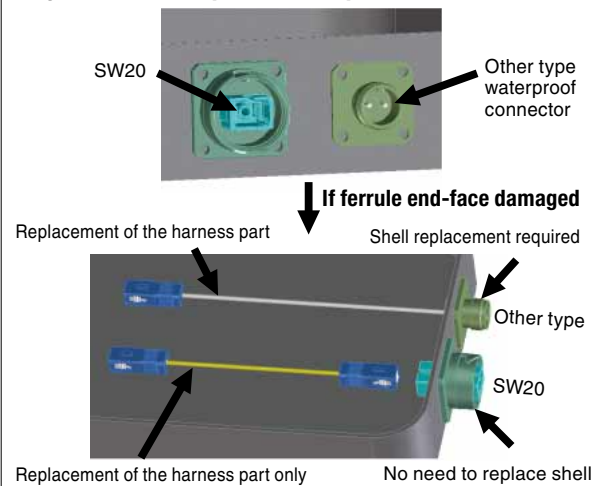

Fig.2

Product Specifications

Ratings	Operating temperature range	-40°C to +85°C	Storage temperature range	-25°C to +70°C (AT PACKING)
	Item	Test method	Requirements	
Construction	General examnation.	Visually and by measuring instrument.	Accoding to drawing.	
	Marking	Confirmed visually.		
Optical characteristics (SM)	Insertion loss	Wavelength 1310±30nm(LD) Wavelength 1550±30nm(LD)	SW side-1310nm: 0.4dB max., 1550nm: 0.5dB max. SC side- 1310nm: 0.3dB max., 1550nm: 0.4dB max.	
	Return loss	Wavelength 1310±30nm(LD)	SW side: 40dB min.(SM), 22dB min.(GI) SC side: 40dB min.(SM), 22dB min.(GI)	
Mechanical characteristics	Tensile strength(axial)	A tensile force to cable axially for 1 minutes at 200N.	Insertion loss range: ≤ 0.3dB No Looseness,breakage,cracks	
	Durability (mating/un-mating)	200 times	1) Insertion loss fluctuation after test:0.3dB max. 2) No visible damage or components dislocation.	
	Vibration	Frequency: 10 to 55Hz, single amplitude of 0.75mm, acceleration of 98.1 m/s ² , 2 hours in each of the 3 axis.		
	Shock	Acceleration of 981 m/s ² , 6 ms duration, half sine shock pulse,10 cycles in each of the 3 axis.		
Environmental characteristics	Humidity (Temperature/humidity-cycles)	-10°C to +65°C, humidity: 90% to 100% 168hours. (12H/cycle×14cycle) (Telcordia GR3120-CORE)	1) Insertion loss fluctuation after test:0.3dB max. 2) No visible damage or components dislocation.	
	Temperature cycle	-40°C to +75°C, 42 cycles,168hours. (8H/cycle×42cycle)(Telcordia GR326-CORE)		
	Dry heat	240 hours at +85°C	No heavy corrosion ruin the function.	
	Cold	240 hours at -40°C		
	Salt mist	Salt mist :5% and temperature 35°C or 1000hours.		
	Water resistance (mating)	Put the product under water for 1min, with air pressure 4.9kPa.	No air leakage.	

Material & Finish

Part	Plug		Receptacle	
	Material	Finish/Remarks	Material	Finish/Remarks
Housing	Zinc alloy die casting	Chrome plated	Zinc alloy	Chrome plated
	Synthetic resin	UL94V-0		
Oring/gasket	Synthetic rubber	—	Synthetic rubber	—
SC/LC	Depend on each connector. (Synthetic resin,Zirconia,spring)	—	Depend on each adapter. (Synthetic resin,Zirconia)	—
Spring	Steel wire	—	—	—
Others (Internal part)	Phosphor bronze	Nickel plated	—	—
	Zinc alloy	Nickel plated	—	—
	Stainless steel	—	—	—

Ordering information

(1) Plug Assembly

SW20 - **SC** **P** **T75** - **1** - **SC** - **LM** - **1**

① ② ③ ④ ⑤ ⑥ ⑦ ⑧

① Series name : SW20	⑤ Suffix
② Connector type : SC...SW20-SC plug LC...SW20-LC plug	⑥ Connector type at the other side ("P2" when SW20 plugs are at both ends)
③ Assembly type P : Single ended P2 : Double ended	⑦ Length in meter
④ Cable type T75 : $\phi 7$ round cable. If you would like other cables, please contact us.	⑧ Suffix

Please contact us in case you need Plug kit only.

(2) Receptacle

SW20 - **SC** **R** - **1**

① ② ③ ④

① Series name : SW20	③ Receptacle R:Receptacle
② Connector type: SC...SW20-SC receptacle LC...SW20-LC recetacle	④ Suffix

(3) Receptacle cap

SW20 - **RC** **1**

① ② ③

① Series name : SW20	③ Suffix 1:Waterproof cap
② Receptacle cap RC:Receptacle cap	3:Dustproof cap(Not waterproof)

(4) Adaptor

SW20 - **LC** **A** - **1**

① ② ③ ④

① Series name : SW20	③ Adaptor A:Adaptor
② Connector type: LC...SW20-LC adaptor	④ Suffix

Receptacle

● SC type

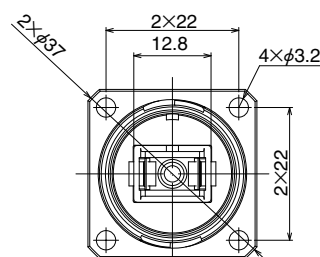
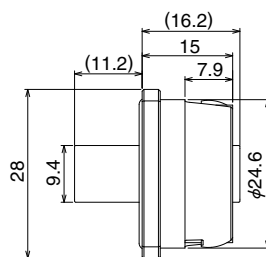

Recommended panel cutouts

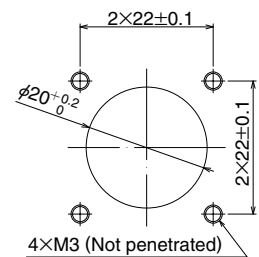

Part No.	HRS No.	Packing style
SW20-SCR-1(01)	717-5002-2 01	1pcs/pack(1 to 9 pcs)
SW20-SCR-1(02)	717-5002-2 02	Tray(10 pcs or more)

Note:LC-type's cutout same as SC-type.

● LC type

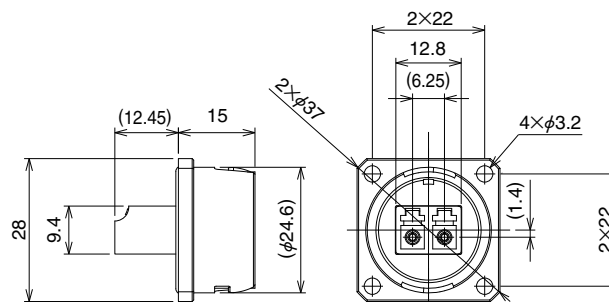
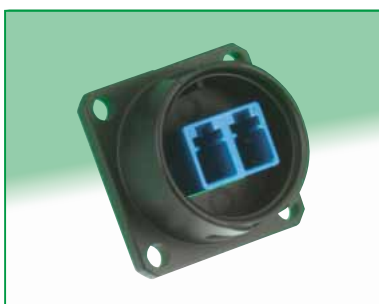

Part No.	HRS No.	Packing style
SW20-LCR-1	717-5004-8 00	1pcs/pack(1 to 9 pcs), Tray(10 pcs or more)

Receptacle Cap

Waterproof type

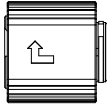

Part No.	HRS No.	Packing style
SW20-RC1(01)	717-5501-2 01	1 pcs/pack

Dustproof type

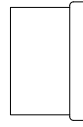

Part No.	HRS No.	Packing style
SW20-RC3	717-5504-0	1 pcs/pack

Note : Without waterproof.

Adaptor

LC type

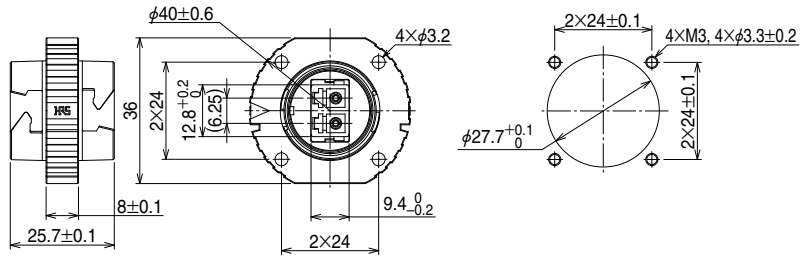

Recommended panel cutouts

Part No.	HRS No.	Packing style
SW20-LCA-1	717-5028-6 00	1 pcs/pack

How to Specify Plug Cable Assembly

SW20-SCPT75-2-SC-LM-*

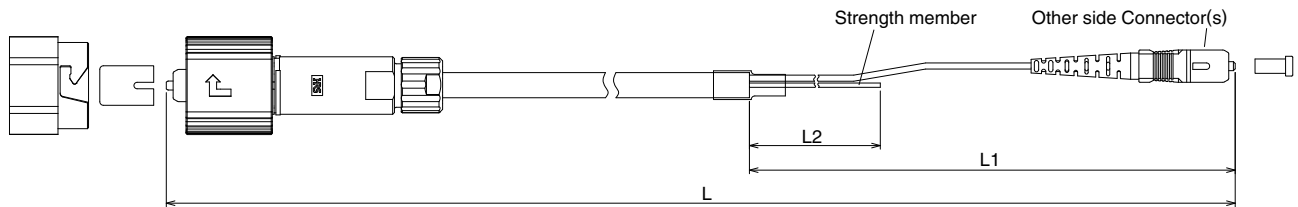

SW20-LCPT75-1-SC-LM-*

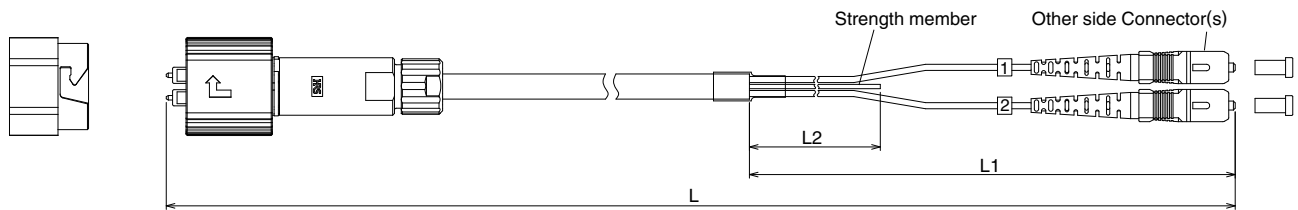

Note 1 : Please specify "L", "L1", and "L2".

Note 2 : Please ask us about custom assemblies, For example you may require an alternate central strength member for the cable or different connectors on the opposite end.



HIROSE ELECTRIC CO.,LTD.

2-6-3,Nakagawa Chuoh,Tsuzuki-Ku,Yokohama-Shi 224-8540,JAPAN
 TEL: +81-45-620-3526 Fax: +81-45-591-3726
<http://www.hirose.com>
<http://www.hirose-connectors.com>

Mouser Electronics

Authorized Distributor

Click to View Pricing, Inventory, Delivery & Lifecycle Information:

[Hirose Electric:](#)

[SW20-SCR-1\(02\)](#) [SW20-LCA-1](#) [SW20-LCR-1](#) [SW20-SCR-1\(01\)](#) [SW20-RC3](#) [SW20-RC1\(01\)](#)