

有关敝公司产品的注意事项 【高度安全性，可靠性的应用设备(汽车室内 / 产业机器)】

请务必在使用敝公司产品之前阅读。

注意

■ 本产品目录中所记载的内容为2017年10月之内容。因改良等原因，可能会不经预告而变更记载内容，所以请务必在使用前先确认最新的产品信息。未按照本产品目录中所记载的内容或交货规格说明书使用敝公司产品的，即便其致使使用设备发生损害、瑕疵等时，敝公司也不承担任何责任，敬请悉知。

■ 就规格相关的详细内容，敝公司备有交货规格说明书，详情请向敝公司咨询。

■ 使用敝公司产品时，请务必事先安装到设备之后，在实际使用的环境下进行评估和确认。

■ 本产品目录中所记载的产品可适用于一般电子设备（音像设备、办公自动化设备、家电产品、办公设备、信息/通讯设备）、医疗设备（国际（IMDRF）第一类，第二类）、产业机器、室内电灯等。若考虑将本产品目录中所记载的产品使用于可能会直接危及生命或身体的设备 [运输用设备（汽车驱动控制设备、火车控制设备、船舶控制设备等）、交通用信号设备、医疗设备（国际（IMDRF）第三类）] 等的，请务必事先向敝公司咨询。

另外，请勿将敝公司产品使用于对安全性和可靠性要求较高的设备（航天设备、航空设备*、医疗设备（国际（IMDRF）第四类）、原子能控制设备、海底设备、军事设备等）。

* 注释：仅限于对航空设备的安全运行不产生直接干扰的设备[机内娱乐设备、机内照明设备、电动座椅、餐饮设备等]，在满足敝公司另行指定的相关条件时，亦可将敝公司产品用于以上用途。在贵公司考虑将敝公司的产品用于以上用途时，请务必事先向敝公司咨询相关的信息。

且即便属于一般电子设备，使用于对安全性和可靠性要求较高的设备、电路上时，敝公司建议进行充分的安全评估，并根据需要，在设计时追加保护电路等。

未经敝公司的事先书面同意，把本产品目录中所记载的产品使用于前述需要向敝公司咨询的设备或敝公司禁止使用的设备，从而给客户或第三方造成损害的，敝公司不承担任何责任，敬请悉知。

■ 本产品目录中所记载的信息是用于说明相关产品的典型操作以及相关应用。此类信息的使用不代表对于敝公司以及第三方的知识产权以及其他权利的使用许可或是不侵权保证。

■ 敝公司产品的保证范围仅限于交付的敝公司产品单品，就敝公司产品的故障或瑕疵所诱发的损害，敝公司不承担任何责任，敬请悉知。但是，以书面形式另行签署了交易基本合同书，品质保证协定书等时，敝公司将根据该合同等的条件提供保证。

■ 本产品目录中所记载的内容适用于从敝公司营业所、销售子公司、销售代理店（即“正规销售渠道”）购买的敝公司产品，并不适用于从上述以外的渠道购买的敝公司产品，敬请悉知。

出口相关注意事项

本产品目录中所记载的部分产品在出口时须事先确认《外汇和对外贸易法》以及美国出口管理的相关法规，并办理相关手续。如有不明之处，请向敝公司咨询。

多层陶瓷电容器

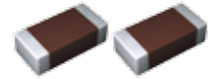

回流焊
AEC-Q200

■ 型号标示法

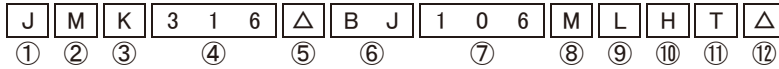

△ = 空格

① 额定电压

代码	额定电压 [VDC]
A	4
J	6.3
L	10
E	16
T	25
G	35
U	50
H	100
Q	250
S	630

② 系列名称

代码	系列名称
M	多层电容器
V	高频多层陶瓷
W	LW 逆转型多层电容器

③ 端接类型

代码	端接类型
K	电镀
J	树脂外部电极品
S	Cu 内部电极产品
F	高可靠用途

④ 外型尺寸

规格	尺寸 L×W [mm]	EIA (inch)
063	0.6 × 0.3	0201
105	1.0 × 0.5	0402
	0.52 × 1.0 ※	0204
107	1.6 × 0.8	0603
	0.8 × 1.6 ※	0306
212	2.0 × 1.25	0805
	1.25 × 2.0 ※	0508
316	3.2 × 1.6	1206
325	3.2 × 2.5	1210
432	4.5 × 3.2	1812

注: ※LW 逆转型 (□WK)

⑤ 产品尺寸公差

代码	规格	L [mm]	W [mm]	T [mm]
△	所有规格	标准	标准	标准
A	063	0.6±0.05	0.3±0.05	0.3±0.05
	105	1.0±0.10	0.5±0.10	0.5±0.10
	107	1.6+0.15/-0.05	0.8+0.15/-0.05	0.8+0.15/-0.05
	212	2.0+0.15/-0.05	1.25+0.15/-0.05	0.85±0.10 1.25+0.15/-0.05
	316	3.2±0.20	1.6±0.20	1.6±0.20
	325	3.2±0.30	2.5±0.30	2.5±0.30
B	105	1.0+0.15/-0.05	0.5+0.15/-0.05	0.5+0.15/-0.05
	107	1.6+0.20/-0	0.8+0.20/-0	0.8+0.20/-0
	212	2.0+0.20/-0	1.25+0.20/-0	0.85±0.10 1.25+0.20/-0
C	105	1.0+0.20/-0	0.5+0.20/-0	0.5+0.20/-0
	107	1.6+0.25/-0	0.8+0.25/-0	0.8+0.25/-0
	212	2.0+0.25/-0	1.25+0.25/-0	1.25+0.25/-0
K	212	2.0±0.15	1.25±0.15	0.85±0.15 1.15±0.20 1.6±0.20
	316	3.2±0.20	1.6±0.20	1.6±0.20
	325	3.2±0.50	2.5±0.30	2.5±0.30

注: 参照标准产品的尺寸

△ = 空格

⑥ 温度特性

■ 高介电常数

代码	适用标准	温度范围 [°C]	基准温度 [°C]	静电容量变化率	静电容量允许偏差	允许偏差代码
BJ	EIA X5R	-55~+85	25	±15%	±10%	K
					±20%	M
C6	EIA X6S	-55~+105	25	±22%	±10%	K
					±20%	M
B7	EIA X7R	-55~+125	25	±15%	±10%	K
					±20%	M
C7	EIA X7S	-55~+125	25	±22%	±10%	K
					±20%	M
D7	EIA X7T	-55~+125	25	+22%/-33%	±10%	K
					±20%	M

▶ 由于篇幅有限, 本产品目录中只记载了有代表性的产品规格。若考虑使用贵司产品时, 请确认交货规格说明书中的详细规格。另外, 有关各产品的详细信息(特性图、可靠性信息、使用时的注意事项等), 请参阅贵司网站(<http://www.ty-top.com/>)。

■温度补偿用

代码	适用标准		温度范围 [°C]	基准温度 [°C]	静电容量变化率	静电容量允许偏差	允许偏差代码
CG	JIS	CG	-55~+125	20	0±30ppm/°C	±0.1pF	B
						±0.25pF	C
	±0.5pF	D					
	±1pF	F					
	±2%	G					
EIA	COG	25	±5%	J			

⑦静电容量

代码 (例)	静电容量
OR5	0.5pF
O10	1pF
100	10pF
101	100pF
102	1,000pF
103	0.01 μ F
104	0.1 μ F
105	1.0 μ F
106	10 μ F
107	100 μ F

注: R=小数点

⑧静电容量允许偏差

代码	静电容量允许偏差
B	±0.1pF
C	±0.25pF
D	±0.5pF
G	±2%
J	±5%
K	±10%
M	±20%

⑨产品厚度

代码	产品厚度 [mm]
P	0.3
T	
V	0.5
C	0.7 (107 型以上)
A	0.8
D	0.85 (212 型以上)
F	1.15
G	1.25
L	1.6
N	1.9
M	2.5

⑩个别规格

代码	个别规格
H	产业机器/汽车室内用

⑪包装

代码	包装规格
F	φ178mm 卷盘带装 (2mm 间距)
R	φ178mm 压纹盘带 (4mm 间距)
T	φ178mm 卷盘带装 (4mm 间距)
P	φ178mm 卷盘带装 (4mm 间距, 1000 个/卷盘) 325 规格 (厚度代码M)

⑫管理记号

代码	管理记号
△	△ 标准

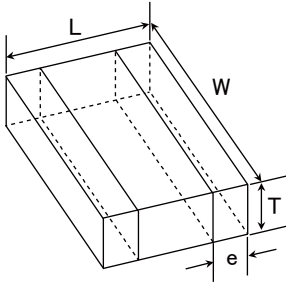
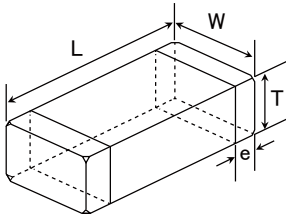

※LW 逆转型

代码 (EIA)	标准产品尺寸 [mm](inch)				
	L	W	T	*1	e
□MK063(0201)	0.6±0.03 (0.024±0.001)	0.3±0.03 (0.012±0.001)	0.3±0.03 (0.012±0.001)	T	0.15±0.05 (0.006±0.002)
□MK105(0402) □MF105(0402)	1.0±0.05 (0.039±0.002)	0.5±0.05 (0.020±0.002)	0.5±0.05 (0.020±0.002)	V	0.25±0.10 (0.010±0.004)
□WK105(0204)※	0.52±0.05 (0.020±0.002)	1.0±0.05 (0.039±0.002)	0.3±0.05 (0.012±0.002)	P	0.18±0.08 (0.007±0.003)
□MK107(0603) □MF107(0603)	1.6±0.10 (0.063±0.004)	0.8±0.10 (0.031±0.004)	0.8±0.10 (0.031±0.004)	A	0.35±0.25 (0.014±0.010)
□MJ107(0603)	1.6±0.10 (0.063±0.004)	0.8±0.10 (0.031±0.004)	0.8±0.10 (0.031±0.004)	A	0.35+0.3/-0.25 (0.014+0.012/-0.010)
□VS107(0603)	1.6±0.10 (0.063±0.004)	0.8±0.10 (0.031±0.004)	0.7±0.10 (0.028±0.004)	C	0.35±0.25 (0.014±0.010)
□WK107(0306)※	0.8±0.10 (0.031±0.004)	1.6±0.10 (0.063±0.004)	0.5±0.05 (0.020±0.002)	V	0.25±0.15 (0.010±0.006)
□MK212(0805) □MF212(0805)	2.0±0.10 (0.079±0.004)	1.25±0.10 (0.049±0.004)	0.85±0.10 (0.033±0.004)	D	0.5±0.25 (0.020±0.010)
1.25±0.10 (0.049±0.004)			G		
□MJ212(0805)	2.0±0.10 (0.079±0.004)	1.25±0.10 (0.049±0.004)	0.85±0.10 (0.033±0.004)	D	0.5+0.35/-0.25 (0.020+0.014/-0.010)
1.25±0.10 (0.049±0.004)			G		
□VS212(0805)	2.0±0.10 (0.079±0.004)	1.25±0.10 (0.049±0.004)	0.85±0.10 (0.033±0.004)	D	0.5±0.25 (0.020±0.010)
□WK212(0508)※	1.25±0.15 (0.049±0.006)	2.0±0.15 (0.079±0.006)	0.85±0.10 (0.033±0.004)	D	0.3±0.2 (0.012±0.008)
□MK316(1206) □MF316(1206)	3.2±0.15 (0.126±0.006)	1.6±0.15 (0.063±0.006)	1.15±0.10 (0.045±0.004)	F	0.5+0.35/-0.25 (0.020+0.014/-0.010)
1.6±0.20 (0.063±0.008)			L		
□MJ316(1206)	3.2±0.15 (0.126±0.006)	1.6±0.15 (0.063±0.006)	1.15±0.10 (0.045±0.004)	F	0.6+0.4/-0.3 (0.024+0.016/-0.012)
1.6±0.20 (0.063±0.008)			L		
□MK325(1210) □MF325(1210)	3.2±0.30 (0.126±0.012)	2.5±0.20 (0.098±0.008)	1.15±0.10 (0.045±0.004)	F	0.6±0.3 (0.024±0.012)
1.9±0.20 (0.075±0.008)			N		
2.5±0.20 (0.098±0.008)			M		
□MJ325(1210)	3.2±0.30 (0.126±0.012)	2.5±0.20 (0.098±0.008)	1.9±0.20 (0.075±0.008)	N	0.6+0.4/-0.3 (0.024+0.016/-0.012)
2.5±0.20 (0.098±0.008)			M		
□MK432(1812)	4.5±0.40 (0.177±0.016)	3.2±0.30 (0.126±0.012)	2.5±0.20 (0.098±0.008)	M	0.9±0.6 (0.035±0.024)

注: ※LW 逆转型、*1 产品厚度代码

■ 标准数量

规格	EIA (inch)	产品厚度		标准数量 [pcs]	
		[mm]	代码	纸带	压纹带
063	0201	0.3	T	15000	—
105	0402	0.5	V	10000	—
	0204 ※	0.30	P		
107	0603	0.7	C	4000	—
		0.8	A		
		0.8	A	3000 (树脂外部电极品)	—
		0.8	A	—	3000 (树脂外部电极品)
	0306 ※	0.50	V	—	4000
212	0805	0.85	D	4000	—
		1.25	G	—	3000
		1.25	G	—	2000 (树脂外部电极品)
	0508 ※	0.85	D	4000	—
316	1206	1.15	F	—	3000
		1.6	L	—	2000
325	1210	1.15	F	—	2000
		1.9	N		
		2.5	M	—	500(T), 1000(P)
432	1812	2.5	M	—	500

注: ※LW 逆转型 (□WK)

■ 型号一览

· 产品目录中的多层陶瓷电容器全部属于RoHS对应品。
 · 请在型号的□中指定静电容量允许偏差代码。
 · 产品目录中的多层陶瓷电容器全部属于回流焊对应品。

注)
 · 根据使用电路和机器, 需要按照相应规格处理。请务必咨询正规销售渠道。
 · *1: 面向汽车室内用途 (AEC-Q200 Qualified) 的产品。
 < AEC-Q200 : AEC-Q200 qualified >
 *1标志的多层陶瓷电容器, 已实施代表项目的AEC-Q200对应评价试验。
 125°C products: AEC-Q200 Grade1 (Grade1的测试条件下的评价实施已完成。)
 105°C products: AEC-Q200 Grade2 (Grade2的测试条件下的评价实施已完成。)
 85°C products: AEC-Q200 Grade3 (Grade3的测试条件下的评价实施已完成。)
 关于本产品的详细规格和评估测试结果等信息, 请咨询官方销售渠道。
 此外, 订购时请索取产品规格书。

· *2: 面向工业设备、医疗设备的产品。
 · *3: 关于尺寸规格, 请参照型号标示法的④外形尺寸、⑤产品尺寸公差、⑨参见产品的厚度、以及标准产品的尺寸。

陶瓷电容器

多层陶瓷电容器 (高介电常数)

● 105TYPE (Dimension: 1.0 × 0.5mm JIS:1005 EIA:0402)

【温度特性 BJ : X5R】 厚度 0.5mm (V)

型号1	型号2	额定电压 [V]	温度特性	静电容量 [F]	静电容量允许偏差 [%]	tan δ [%]	高温负载		厚度*3 [mm]	注释
							额定电压 x %			
UMK105 BJ102□VHF		50	X5R	1000 p	±10, ±20	2.5	200	0.5±0.05	*1, *2	
UMK105 BJ152□VHF			X5R	1500 p	±10, ±20	2.5	200	0.5±0.05	*1, *2	
UMK105 BJ222□VHF			X5R	2200 p	±10, ±20	2.5	200	0.5±0.05	*1, *2	
UMK105 BJ332□VHF			X5R	3300 p	±10, ±20	2.5	200	0.5±0.05	*1, *2	
UMK105 BJ472□VHF			X5R	4700 p	±10, ±20	2.5	200	0.5±0.05	*1, *2	
UMK105 BJ682□VHF			X5R	6800 p	±10, ±20	2.5	150	0.5±0.05	*1, *2	
UMK105 BJ103□VHF			X5R	0.01 μ	±10, ±20	3.5	200	0.5±0.05	*1, *2	
UMK105 BJ223□VHF			X5R	0.022 μ	±10, ±20	5	200	0.5±0.05	*1, *2	
UMK105 BJ473□VHF			X5R	0.047 μ	±10, ±20	5	200	0.5±0.05	*1, *2	
UMK105 BJ104□VHF			X5R	0.1 μ	±10, ±20	10	150	0.5±0.05	*1, *2	
TMK105 BJ472□VHF		25	X5R	4700 p	±10, ±20	2.5	200	0.5±0.05	*1, *2	
TMK105 BJ682□VHF			X5R	6800 p	±10, ±20	2.5	200	0.5±0.05	*1, *2	
TMK105 BJ103□VHF			X5R	0.01 μ	±10, ±20	3.5	200	0.5±0.05	*1, *2	
TMK105 BJ223□VHF			X5R	0.022 μ	±10, ±20	3.5	200	0.5±0.05	*1, *2	
TMK105 BJ473□VHF			X5R	0.047 μ	±10, ±20	3.5	150	0.5±0.05	*1, *2	
TMK105 BJ104□VHF			X5R	0.1 μ	±10, ±20	5	150	0.5±0.05	*1, *2	
TMK105 BJ224□VHF			X5R	0.22 μ	±10, ±20	10	150	0.5±0.05	*1, *2	
TMK105ABJ474□VHF			X5R	0.47 μ	±10, ±20	10	150	0.5±0.10	*1, *2	
EMK105 BJ103□VHF			16	X5R	0.01 μ	±10, ±20	3.5	200	0.5±0.05	*1, *2
EMK105 BJ223□VHF				X5R	0.022 μ	±10, ±20	3.5	200	0.5±0.05	*1, *2
EMK105 BJ473□VHF		X5R		0.047 μ	±10, ±20	3.5	150	0.5±0.05	*1, *2	
EMK105 BJ104□VHF		X5R		0.1 μ	±10, ±20	5	150	0.5±0.05	*1, *2	
EMK105 BJ224□VHF		X5R		0.22 μ	±10, ±20	10	150	0.5±0.05	*1, *2	
EMK105ABJ474□VHF		X5R		0.47 μ	±10, ±20	10	150	0.5±0.10	*1, *2	
EMK105 BJ105□VHF		X5R		1 μ	±10, ±20	10	150	0.5±0.05	*1, *2	
LМК105 BJ473□VHF		10		X5R	0.047 μ	±10, ±20	3.5	150	0.5±0.05	*1, *2
LМК105 BJ104□VHF				X5R	0.1 μ	±10, ±20	5	150	0.5±0.05	*1, *2
LМК105 BJ224□VHF				X5R	0.22 μ	±10, ±20	5	150	0.5±0.05	*1, *2
LМК105ABJ474□VHF			X5R	0.47 μ	±10, ±20	10	150	0.5±0.10	*1, *2	
LМК105 BJ105□VHF			X5R	1 μ	±10, ±20	10	150	0.5±0.05	*1, *2	
LМК105ABJ225□VHF			X5R	2.2 μ	±10, ±20	10	150	0.5±0.10	*1, *2	
JMK105 BJ104□VHF			6.3	X5R	0.1 μ	±10, ±20	5	150	0.5±0.05	*1, *2
JMK105 BJ224□VHF				X5R	0.22 μ	±10, ±20	5	150	0.5±0.05	*1, *2
JMK105 BJ474□VHF				X5R	0.47 μ	±10, ±20	10	150	0.5±0.05	*1, *2
JMK105 BJ105□VHF				X5R	1 μ	±10, ±20	10	150	0.5±0.05	*1, *2
JMK105 BJ225□VHF		X5R		2.2 μ	±10, ±20	10	150	0.5±0.05	*1, *2	
JMK105BBJ475MVHF		X5R		4.7 μ	±20	10	150	0.5+0.15/-0.05	*1, *2	
AMK105 BJ225□VHF		4		X5R	2.2 μ	±10, ±20	10	150	0.5±0.05	*1, *2
AMK105BBJ475MVHF				X5R	4.7 μ	±20	10	150	0.5+0.15/-0.05	*1, *2
AMK105CBJ106MVHF				X5R	10 μ	±20	10	150	0.5+0.20/-0	*1, *2
AMK105CBJ106MVHF				X5R	10 μ	±20	10	150	0.5+0.20/-0	*1, *2

【温度特性 B7 : X7R】 厚度 0.5mm (V)

型号1	型号2	额定电压 [V]	温度特性	静电容量 [F]	静电容量允许偏差 [%]	tan δ [%]	高温负载		厚度*3 [mm]	注释
							额定电压 x %			
UMK105 B7102□VHF		50	X7R	1000 p	±10, ±20	2.5	200	0.5±0.05	*1, *2	
UMK105 B7152□VHF			X7R	1500 p	±10, ±20	2.5	200	0.5±0.05	*1, *2	
UMK105 B7222□VHF			X7R	2200 p	±10, ±20	2.5	200	0.5±0.05	*1, *2	
UMK105 B7332□VHF			X7R	3300 p	±10, ±20	2.5	200	0.5±0.05	*1, *2	
UMK105 B7472□VHF			X7R	4700 p	±10, ±20	2.5	150	0.5±0.05	*1, *2	
UMK105 B7682□VHF			X7R	6800 p	±10, ±20	2.5	150	0.5±0.05	*1, *2	
UMK105 B7103□VHF			X7R	0.01 μ	±10, ±20	3.5	150	0.5±0.05	*1, *2	
UMK105 B7223□VHF			X7R	0.022 μ	±10, ±20	10	200	0.5±0.05	*1, *2	
UMK105 B7473□VHF			X7R	0.047 μ	±10, ±20	10	200	0.5±0.05	*1, *2	
UMK105 B7104□VHF			X7R	0.1 μ	±10, ±20	10	150	0.5±0.05	*1, *2	
TMK105 B7472□VHF		25	X7R	4700 p	±10, ±20	2.5	200	0.5±0.05	*1, *2	
TMK105 B7682□VHF			X7R	6800 p	±10, ±20	2.5	200	0.5±0.05	*1, *2	
TMK105 B7103□VHF			X7R	0.01 μ	±10, ±20	3.5	200	0.5±0.05	*1, *2	
TMK105 B7223□VHF			X7R	0.022 μ	±10, ±20	3.5	150	0.5±0.05	*1, *2	
TMK105 B7473□VHF			X7R	0.047 μ	±10, ±20	3.5	150	0.5±0.05	*1, *2	
TMK105 B7104□VHF			X7R	0.1 μ	±10, ±20	10	150	0.5±0.05	*1, *2	
EMK105 B7103□VHF			16	X7R	0.01 μ	±10, ±20	3.5	200	0.5±0.05	*1, *2
EMK105 B7223□VHF				X7R	0.022 μ	±10, ±20	3.5	150	0.5±0.05	*1, *2
EMK105 B7473□VHF				X7R	0.047 μ	±10, ±20	3.5	150	0.5±0.05	*1, *2
EMK105 B7104□VHF				X7R	0.1 μ	±10, ±20	5	150	0.5±0.05	*1, *2
EMK105 B7224□VHF		X7R	0.22 μ	±10, ±20	10	150	0.5±0.05	*1, *2		

▶ 由于篇幅有限, 本产品目录中只记载了有代表性的产品规格。若考虑使用弊公司产品时, 请确认交货规格说明书中的详细规格。另外, 有关各产品的详细信息(特性图、可靠性信息、使用时的注意事项等), 请参阅弊网站(<http://www.ty-top.com/>)。

■ 型号一览

型号1	型号2	额定电压 [V]	温度特性		静电容量 [F]	静电容量允许偏差 [%]	tan δ [%]	高温负载	厚度*3 [mm]	注释
								额定电压 x %		
LMK105 B7473□VHF		10	X7R	0.047 μ	±10, ±20	3.5	150	0.5±0.05	*1, *2	
LMK105 B7104□VHF	150									
LMK105 B7224□VHF	150									
JMK105 B7104□VHF		6.3	X7R	0.1 μ	±10, ±20	5	150	0.5±0.05	*1, *2	
JMK105 B7224□VHF	150									
JMK105 B7474□VHF	150									
AMK105 B7474□VHF		4	X7R	0.47 μ	±10, ±20	10	150	0.5±0.05	*1, *2	

● 107TYPE (Dimension:1.6×0.8mm JIS:1608 EIA:0603)

【温度特性 BJ : X5R】 厚度 0.8mm (A)

型号1	型号2	额定电压 [V]	温度特性		静电容量 [F]	静电容量允许偏差 [%]	tan δ [%]	高温负载	厚度*3 [mm]	注释
								额定电压 x %		
UMK107 BJ104□AHT		50	X5R	0.1 μ	±10, ±20	3.5	150	0.8±0.10	*1, *2	
UMK107 BJ224□AHT	150									
UMK107 BJ474□AHT	150									
UMK107ABJ105□AHT		35	X5R	1 μ	±10, ±20	10	150	0.8±0.10	*1, *2	
GMK107 BJ223□AHT	200									
GMK107 BJ473□AHT	200									
GMK107 BJ104□AHT		25	X5R	0.1 μ	±10, ±20	3.5	150	0.8±0.10	*1, *2	
GMK107 BJ224□AHT	150									
GMK107 BJ474□AHT	150									
TMK107 BJ223□AHT		16	X5R	0.22 μ	±10, ±20	2.5	200	0.8±0.10	*1, *2	
TMK107 BJ473□AHT	200									
TMK107 BJ104□AHT	150									
TMK107 BJ224□AHT		10	X5R	0.22 μ	±10, ±20	5	150	0.8±0.10	*1, *2	
TMK107 BJ474□AHT	150									
TMK107 BJ105□AHT	150									
TMK107BBJ225□AHT		6.3	X5R	2.2 μ	±10, ±20	10	150	0.8±0.10	*1, *2	
EMK107 BJ104□AHT	150									
EMK107 BJ224□AHT	150									
EMK107 BJ474□AHT		4	X5R	4.7 μ	±10, ±20	10	150	0.8±0.10	*1, *2	
EMK107 BJ105□AHT	150									
EMK107ABJ225□AHT	150									
EMK107BBJ475□AHT		10	X5R	0.47 μ	±10, ±20	3.5	150	0.8±0.10	*1, *2	
LMK107 BJ474□AHT	150									
LMK107 BJ105□AHT	150									
LMK107 BJ225□AHT		6.3	X5R	2.2 μ	±10, ±20	10	150	0.8±0.10	*1, *2	
LMK107 BJ475□AHT	150									
LMK107BBJ106MAHT	150									
JMK107 BJ105□AHT		4	X5R	10 μ	±10, ±20	10	150	0.8±0.10	*1, *2	
JMK107 BJ225□AHT	150									
JMK107 BJ475□AHT	150									
JMK107ABJ106□AHT		10	X5R	4.7 μ	±10, ±20	10	150	0.8±0.10	*1, *2	
AMK107ABJ106□AHT	150									
AMK107BBJ226MAHT	150									

【温度特性 B7 : X7R, C7 : X7S, D7 : X7T】 厚度 0.8mm (A)

型号1	型号2	额定电压 [V]	温度特性		静电容量 [F]	静电容量允许偏差 [%]	tan δ [%]	高温负载	厚度*3 [mm]	注释
								额定电压 x %		
UMK107 B7102□AHT		50	X7R	1000 p	±10, ±20	3.5	200	0.8±0.10	*1, *2	
UMK107 B7152□AHT	200									
UMK107 B7222□AHT	200									
UMK107 B7332□AHT		35	X7R	3300 p	±10, ±20	3.5	200	0.8±0.10	*1, *2	
UMK107 B7472□AHT	200									
UMK107 B7682□AHT	200									
UMK107 B7103□AHT		25	X7R	0.01 μ	±10, ±20	3.5	200	0.8±0.10	*1, *2	
UMK107 B7223□AHT	200									
UMK107 B7473□AHT	200									
UMK107 B7104□AHT		16	X7R	0.047 μ	±10, ±20	3.5	200	0.8±0.10	*1, *2	
UMK107 C7224□AHTE	150									
GMK107 B7473□AHT	150									
GMK107 B7104□AHT		10	X7R	0.1 μ	±10, ±20	3.5	150	0.8±0.10	*1, *2	
GMK107 B7224□AHT	150									
GMK107 B7474□AHT	150									
GMK107ABJ105□AHT		6.3	X7R	0.22 μ	±10, ±20	10	150	0.8±0.10	*1, *2	
TMK107 B7223□AHT	200									
TMK107 B7473□AHT	200									
TMK107 B7104□AHT		4	X7R	0.47 μ	±10, ±20	10	150	0.8±0.10	*1, *2	
TMK107 B7224□AHT	150									
TMK107 B7474□AHT	150									
EMK107 AB7105□AHT		10	X7R	1 μ	±10, ±20	10	150	0.8±0.10	*1, *2	
EMK107 B7473□AHT	150									
EMK107 B7104□AHT	150									
EMK107 B7224□AHT		6.3	X7R	0.22 μ	±10, ±20	5	150	0.8±0.10	*1, *2	
EMK107 B7474□AHT	150									
EMK107 B7105□AHT	150									
LMK107 B7224□AHT		10	X7R	0.47 μ	±10, ±20	3.5	150	0.8±0.10	*1, *2	
LMK107 B7474□AHT	150									
LMK107 B7105□AHT	150									
LMK107BD7225□AHT		4	X7T	2.2 μ	±10, ±20	10	200	0.8±0.10	*1, *2	
JMK107 B7105□AHT	150									
JMK107 B7225□AHT	150									

▶ 由于篇幅有限，本产品目录中只记载了有代表性的产品规格，若考虑使用弊公司产品时，请确认交货规格说明书中的详细规格。另外，有关各产品的详细信息(特性图、可靠性信息、使用时的注意事项等)，请参阅弊公司网站(<http://www.ty-top.com/>)。

● 型号一览

● 212TYPE (Dimension:2.0×1.25mm JIS:2012 EIA:0805)

【温度特性 BJ : X5R】厚度 1.25mm (G)

型号1	型号2	额定电压 [V]	温度特性	静电容量 [F]	静电容量允许偏差 [%]	tan δ [%]	高温负载	厚度*3 [mm]	注释
							额定电压 x %		
UMK212 BJ104□GHT		50	X5R	0.1 μ	±10, ±20	3.5	200	1.25±0.10	*1, *2
UMK212 BJ224□GHT			X5R	0.22 μ	±10, ±20	3.5	200	1.25±0.10	*1, *2
UMK212 BJ474□GHT			X5R	0.47 μ	±10, ±20	3.5	150	1.25±0.10	*1, *2
UMK212 BJ105□GHT		35	X5R	1 μ	±10, ±20	5	150	1.25±0.10	*1, *2
GMK212 BJ104□GHT			X5R	0.1 μ	±10, ±20	3.5	200	1.25±0.10	*1, *2
GMK212 BJ224□GHT			X5R	0.22 μ	±10, ±20	3.5	150	1.25±0.10	*1, *2
GMK212 BJ474□GHT		25	X5R	0.47 μ	±10, ±20	3.5	150	1.25±0.10	*1, *2
GMK212 BJ105□GHT			X5R	1 μ	±10, ±20	5	150	1.25±0.10	*1, *2
GMK212BBJ225□GHT			X5R	2.2 μ	±10, ±20	10	150	1.25±0.20/-0	*1, *2
TMK212 BJ104□GHT		16	X5R	0.1 μ	±10, ±20	3.5	200	1.25±0.10	*1, *2
TMK212 BJ224□GHT			X5R	0.22 μ	±10, ±20	3.5	150	1.25±0.10	*1, *2
TMK212 BJ474□GHT			X5R	0.47 μ	±10, ±20	3.5	200	1.25±0.10	*1, *2
TMK212 BJ105□GHT		10	X5R	1 μ	±10, ±20	3.5	150	1.25±0.10	*1, *2
TMK212 BJ225□GHT			X5R	2.2 μ	±10, ±20	5	150	1.25±0.10	*1, *2
TMK212BBJ475□GHT			X5R	4.7 μ	±10, ±20	10	150	1.25±0.20/-0	*1, *2
TMK212BBJ106□GHT		6.3	X5R	10 μ	±10, ±20	10	150	1.25±0.20/-0	*1, *2
EMK212 BJ105□GHT			X5R	1 μ	±10, ±20	3.5	150	1.25±0.10	*1, *2
EMK212 BJ225□GHT			X5R	2.2 μ	±10, ±20	5	150	1.25±0.10	*1, *2
EMK212ABJ475□GHT		4	X5R	4.7 μ	±10, ±20	10	150	1.25±0.15/-0.05	*1, *2
EMK212BBJ106□GHT			X5R	10 μ	±10, ±20	10	150	1.25±0.20/-0	*1, *2
LMK212 BJ225□GHT			X5R	2.2 μ	±10, ±20	5	200	1.25±0.10	*1, *2
LMK212ABJ475□GHT		10	X5R	4.7 μ	±10, ±20	10	150	1.25±0.15/-0.05	*1, *2
LMK212ABJ106□GHT			X5R	10 μ	±10, ±20	10	150	1.25±0.15/-0.05	*1, *2
JMK212ABJ475□GHT			X5R	4.7 μ	±10, ±20	5	200	1.25±0.15/-0.05	*1, *2
JMK212ABJ106□GHT		6.3	X5R	10 μ	±10, ±20	10	150	1.25±0.15/-0.05	*1, *2
JMK212BBJ226MGHT			X5R	22 μ	±20	10	150	1.25±0.20/-0	*1, *2
AMK212ABJ226MGHT			4	X5R	22 μ	±20	10	150	1.25±0.15/-0.05
AMK212BBJ476MGHT		X5R		47 μ	±20	10	150	1.25±0.20/-0	*1, *2

【温度特性 BJ : X5R】厚度 0.85mm (D)

型号1	型号2	额定电压 [V]	温度特性	静电容量 [F]	静电容量允许偏差 [%]	tan δ [%]	高温负载	厚度*3 [mm]	注释
							额定电压 x %		
EMK212 BJ105□DHT		16	X5R	1 μ	±10, ±20	5	200	0.85±0.10	*1, *2
EMK212ABJ225□DHT			X5R	2.2 μ	±10, ±20	5	150	0.85±0.10	*1, *2
EMK212BBJ475□DHT			X5R	4.7 μ	±10, ±20	10	150	0.85±0.10	*1, *2

【温度特性 B7 : X7R】厚度 1.25mm (G)

型号1	型号2	额定电压 [V]	温度特性	静电容量 [F]	静电容量允许偏差 [%]	tan δ [%]	高温负载	厚度*3 [mm]	注释
							额定电压 x %		
UMK212 B7103□GHT		50	X7R	0.01 μ	±10, ±20	3.5	200	1.25±0.10	*1, *2
UMK212 B7223□GHT			X7R	0.022 μ	±10, ±20	3.5	200	1.25±0.10	*1, *2
UMK212 B7473□GHT			X7R	0.047 μ	±10, ±20	3.5	200	1.25±0.10	*1, *2
UMK212 B7104□GHT		35	X7R	0.1 μ	±10, ±20	3.5	200	1.25±0.10	*1, *2
UMK212 B7224□GHT			X7R	0.22 μ	±10, ±20	3.5	150	1.25±0.10	*1, *2
UMK212 B7105□GHT			X7R	1 μ	±10, ±20	10	150	1.25±0.10	*1, *2
GMK212 B7224□GHT		25	X7R	0.22 μ	±10, ±20	3.5	150	1.25±0.10	*1, *2
GMK212 B7105□GHT			X7R	1 μ	±10, ±20	10	150	1.25±0.10	*1, *2
GMK212 B7105□GHTR			X7R	1 μ	±10, ±20	10	150	1.25±0.10	*1, *2
TMK212 B7224□GHT		16	X7R	0.22 μ	±10, ±20	3.5	150	1.25±0.10	*1, *2
TMK212 B7474□GHT			X7R	0.47 μ	±10, ±20	3.5	200	1.25±0.10	*1, *2
TMK212 B7105□GHTR			X7R	1 μ	±10, ±20	10	150	1.25±0.10	*1, *2
EMK212 B7224□GHT		10	X7R	0.22 μ	±10, ±20	3.5	200	1.25±0.10	*1, *2
EMK212 B7474□GHT			X7R	0.47 μ	±10, ±20	3.5	200	1.25±0.10	*1, *2
EMK212 B7105□GHTR			X7R	1 μ	±10, ±20	10	150	1.25±0.10	*1, *2
EMK212 B7225□GHT		6.3	X7R	2.2 μ	±10, ±20	10	150	1.25±0.10	*1, *2
EMK212 B7224□GHT			X7R	0.22 μ	±10, ±20	3.5	200	1.25±0.10	*1, *2
EMK212 B7475□GHT			X7R	4.7 μ	±10, ±20	10	150	1.25±0.10	*1, *2
LMK212 B7105□GHTR		10	X7R	1 μ	±10, ±20	10	150	1.25±0.10	*1, *2
LMK212 B7225□GHT			X7R	2.2 μ	±10, ±20	10	150	1.25±0.10	*1, *2
LMK212 B7475□GHT			X7R	4.7 μ	±10, ±20	10	150	1.25±0.10	*1, *2
JMK212 B7475□GHT		6.3	X7R	4.7 μ	±10, ±20	10	150	1.25±0.10	*1, *2
JMK212AB7106□GHT			X7R	10 μ	±10, ±20	10	150	1.25±0.15/-0.05	*1, *2

● 316TYPE (Dimension:3.2×1.6mm JIS:3216 EIA:1206)

【温度特性 BJ : X5R】厚度 1.6mm (L)

型号1	型号2	额定电压 [V]	温度特性	静电容量 [F]	静电容量允许偏差 [%]	tan δ [%]	高温负载	厚度*3 [mm]	注释
							额定电压 x %		
UMK316 BJ474□LHT		50	X5R	0.47 μ	±10, ±20	3.5	200	1.6±0.20	*1, *2
UMK316 BJ105□LHT			X5R	1 μ	±10, ±20	3.5	200	1.6±0.20	*1, *2
UMK316 BJ225□LHT			X5R	2.2 μ	±10, ±20	10	150	1.6±0.20	*1, *2
UMK316ABJ475□LHT		35	X5R	4.7 μ	±10, ±20	10	150	1.6±0.20	*1, *2
GMK316 BJ105□LHT			X5R	1 μ	±10, ±20	3.5	200	1.6±0.20	*1, *2
GMK316 BJ225□LHT			X5R	2.2 μ	±10, ±20	10	150	1.6±0.20	*1, *2
GMK316 BJ475□LHT		25	X5R	4.7 μ	±10, ±20	10	150	1.6±0.20	*1, *2
GMK316BBJ106□LHT			X5R	10 μ	±10, ±20	10	150	1.6±0.30	*1, *2
TMK316 BJ225□LHT			X5R	2.2 μ	±10, ±20	3.5	200	1.6±0.20	*1, *2
TMK316 BJ475□LHT		16	X5R	4.7 μ	±10, ±20	5	150	1.6±0.20	*1, *2
TMK316 BJ106□LHT			X5R	10 μ	±10, ±20	5	150	1.6±0.20	*1, *2
EMK316 BJ225□LHT			X5R	2.2 μ	±10, ±20	3.5	200	1.6±0.20	*1, *2
EMK316 BJ475□LHT		10	X5R	4.7 μ	±10, ±20	5	150	1.6±0.20	*1, *2
EMK316 BJ106□LHT			X5R	10 μ	±10, ±20	5	150	1.6±0.20	*1, *2
EMK316BBJ226MLHT			X5R	22 μ	±20	10	150	1.6±0.30	*1, *2
LMK316 BJ475□LHT		10	X5R	4.7 μ	±10, ±20	5	150	1.6±0.20	*1, *2
LMK316 BJ106□LHT			X5R	10 μ	±10, ±20	5	150	1.6±0.20	*1, *2
LMK316ABJ226□LHT			X5R	22 μ	±10, ±20	10	150	1.6±0.20	*1, *2

► 由于篇幅有限, 本产品目录中只记载了有代表性的产品规格, 若考虑使用敝公司产品时, 请确认交货规格说明书中的详细规格, 另外, 有关各产品的详细信息(特性图、可靠性信息、使用时的注意事项等), 请参阅敝公司网站(<http://www.ty-top.com/>)。

■ 型号一览

型号1	型号2	额定电压 [V]	温度特性		静电容量 [F]	静电容量允许偏差 [%]	tan δ [%]	高温负载	厚度*3 [mm]	注释
								额定电压 x %		
JMK316 BJ106□LHT		6.3		X5R	10 μ	±10, ±20	5	200	1.6±0.20	*1, *2
JMK316ABJ226□LHT			X5R	22 μ	±10, ±20	10	150	1.6±0.20	*1, *2	
JMK316ABJ476□MLHT			X5R	47 μ	±20	10	150	1.6±0.20	*1, *2	
JMK316BBJ107MLHT			X5R	100 μ	±20	10	150	1.6±0.30	*2	
AMK316ABJ107MLHT		4		X5R	100 μ	±20	10	150	1.6±0.20	*2

【温度特性 B7: X7R, C7: X7S】厚度 1.6mm (L)

型号1	型号2	额定电压 [V]	温度特性		静电容量 [F]	静电容量允许偏差 [%]	tan δ [%]	高温负载	厚度*3 [mm]	注释
								额定电压 x %		
UMK316 B7473□LHT		50		X7R	0.047 μ	±10, ±20	3.5	200	1.6±0.20	*1, *2
UMK316 B7104□LHT			X7R	0.1 μ	±10, ±20	3.5	200	1.6±0.20	*1, *2	
UMK316 B7224□LHT			X7R	0.22 μ	±10, ±20	3.5	200	1.6±0.20	*1, *2	
UMK316 B7474□LHT			X7R	0.47 μ	±10, ±20	3.5	200	1.6±0.20	*1, *2	
UMK316 B7105□LHT			X7R	1 μ	±10, ±20	3.5	200	1.6±0.20	*1, *2	
UMK316 B7225□LHT			X7R	2.2 μ	±10, ±20	10	150	1.6±0.20	*1, *2	
UMK316AC7475□LHTE			X7S	4.7 μ	±10, ±20	2.5	150	1.6±0.20	*1, *2	
GMK316 B7105□LHT			X7R	1 μ	±10, ±20	3.5	200	1.6±0.20	*1, *2	
GMK316 B7225□LHT			X7R	2.2 μ	±10, ±20	10	150	1.6±0.20	*1, *2	
GMK316AB7475□LHT			X7R	4.7 μ	±10, ±20	10	150	1.6±0.20	*1, *2	
TMK316 B7105□LHT			X7R	1 μ	±10, ±20	3.5	200	1.6±0.20	*1, *2	
TMK316 B7225□LHT			X7R	2.2 μ	±10, ±20	3.5	200	1.6±0.20	*1, *2	
TMK316AB7475□LHT		X7R	4.7 μ	±10, ±20	10	150	1.6±0.20	*1, *2		
TMK316AB7106□LHT		X7R	10 μ	±10, ±20	10	150	1.6±0.20	*1, *2		
EMK316 B7225□LHT		16		X7R	2.2 μ	±10, ±20	3.5	200	1.6±0.20	*1, *2
EMK316AB7475□LHT			X7R	4.7 μ	±10, ±20	10	150	1.6±0.20	*1, *2	
EMK316AB7106□LHT			X7R	10 μ	±10, ±20	10	150	1.6±0.20	*1, *2	
LMK316 B7475□LHT		10		X7R	4.7 μ	±10, ±20	5	150	1.6±0.20	*1, *2
LMK316AB7106□LHT			X7R	10 μ	±10, ±20	10	150	1.6±0.20	*1, *2	
JMK316AB7106□LHT		6.3		X7R	10 μ	±10, ±20	10	150	1.6±0.20	*1, *2
JMK316AB7226□LHT			X7R	22 μ	±10, ±20	10	150	1.6±0.20	*1, *2	
AMK316AB7226□LHT		4		X7R	22 μ	±10, ±20	10	150	1.6±0.20	*1, *2
AMK316AC7476MLHT			X7S	47 μ	±20	10	150	1.6±0.20	*1, *2	

● 325TYPE (Dimension:3.2×2.5mm JIS:3225 EIA:1210)

【温度特性 BJ: X5R】厚度 2.5mm (M)

型号1	型号2	额定电压 [V]	温度特性		静电容量 [F]	静电容量允许偏差 [%]	tan δ [%]	高温负载	厚度*3 [mm]	注释
								额定电压 x %		
UMK325 BJ106□MHP		50		X5R	10 μ	±10, ±20	5	150	2.5±0.20	*1, *2
GMK325 BJ106□MHP		35		X5R	10 μ	±10, ±20	5	150	2.5±0.20	*1, *2
TMK325 BJ106□MHP		25		X5R	10 μ	±10, ±20	5	150	2.5±0.20	*1, *2
EMK325 BJ226□MHP		16		X5R	22 μ	±10, ±20	5	150	2.5±0.20	*1, *2
EMK325ABJ476□MHP			X5R	47 μ	±10, ±20	10	150	2.5±0.30	*1, *2	
LMK325 BJ226□MHP		10		X5R	22 μ	±10, ±20	5	150	2.5±0.20	*1, *2
LMK325 BJ476□MHP			X5R	47 μ	±10, ±20	10	150	2.5±0.20	*1, *2	
LMK325ABJ107MMHP			X5R	100 μ	±20	10	150	2.5±0.30	*2	
JMK325 BJ476□MHP			X5R	47 μ	±10, ±20	10	150	2.5±0.20	*1, *2	
JMK325ABJ107MMHP		6.3		X5R	100 μ	±20	10	150	2.5±0.30	*2
AMK325ABJ107MMHP			X5R	100 μ	±20	10	150	2.5±0.30	*2	
AMK325ABJ227MMHP		4		X5R	220 μ	±20	10	150	2.5±0.30	*2

【温度特性 BJ: X5R】厚度 1.9mm (N)

型号1	型号2	额定电压 [V]	温度特性		静电容量 [F]	静电容量允许偏差 [%]	tan δ [%]	高温负载	厚度*3 [mm]	注释
								额定电压 x %		
UMK325 BJ475□NHHT		50		X5R	4.7 μ	±10, ±20	10	150	1.9±0.20	*1, *2
GMK325 BJ225MNHT		35		X5R	2.2 μ	±20	3.5	200	1.9±0.20	*1, *2
GMK325 BJ475□NHHT			X5R	4.7 μ	±10, ±20	10	150	1.9±0.20	*1, *2	
TMK325 BJ475□NHHT		25		X5R	4.7 μ	±10, ±20	10	150	1.9±0.20	*1, *2
EMK325 BJ475MNHT		16		X5R	4.7 μ	±10, ±20	3.5	200	1.9±0.20	*1, *2
EMK325 BJ106□NHHT			X5R	10 μ	±10, ±20	5	150	1.9±0.20	*1, *2	

【温度特性 C6: X6S】厚度 2.5mm (M)

型号1	型号2	额定电压 [V]	温度特性		静电容量 [F]	静电容量允许偏差 [%]	tan δ [%]	高温负载	厚度*3 [mm]	注释
								额定电压 x %		
JMK325AC6107MMHP		6.3		X6S	100 μ	±20	10	150	2.5±0.30	*2

【温度特性 B7: X7R】厚度 2.5mm (M)

型号1	型号2	额定电压 [V]	温度特性		静电容量 [F]	静电容量允许偏差 [%]	tan δ [%]	高温负载	厚度*3 [mm]	注释
								额定电压 x %		
UMK325 B7475□MHP		50		X7R	4.7 μ	±10, ±20	5	150	2.5±0.20	*1, *2
UMK325AB7106□MHP			X7R	10 μ	±10, ±20	10	150	2.5±0.30	*1, *2	
GMK325AB7106□MHP		35		X7R	10 μ	±10, ±20	10	150	2.5±0.30	*1, *2
TMK325AB7106□MHPR			X7R	10 μ	±10, ±20	10	150	2.5±0.30	*1, *2	
TMK325 B7226□MHP		25		X7R	22 μ	±10, ±20	10	150	2.5±0.20	*1, *2
EMK325 B7226□MHP			X7R	22 μ	±10, ±20	10	150	2.5±0.20	*1, *2	
LMK325 B7226□MHP		16		X7R	22 μ	±10, ±20	10	150	2.5±0.20	*1, *2
JMK325 B7226□MHPR		10		X7R	22 μ	±10, ±20	10	150	2.5±0.20	*1, *2
JMK325 B7226□MHP			X7R	22 μ	±10, ±20	10	150	2.5±0.20	*1, *2	
JMK325 B7226□MHPR		6.3		X7R	22 μ	±10, ±20	10	150	2.5±0.20	*1, *2
JMK325 B7476□MHPR			X7R	47 μ	±10, ±20	10	150	2.5±0.20	*1, *2	

【温度特性 B7: X7R】厚度 1.9mm (N)

型号1	型号2	额定电压 [V]	温度特性		静电容量 [F]	静电容量允许偏差 [%]	tan δ [%]	高温负载	厚度*3 [mm]	注释
								额定电压 x %		
GMK325 B7225□NHHT		35		X7R	2.2 μ	±10, ±20	3.5	200	1.9±0.20	*1, *2
GMK325 B7475□NHTR			X7R	4.7 μ	±10, ±20	10	150	1.9±0.20	*1, *2	
TMK325 B7475□NHHT		25		X7R	4.7 μ	±10, ±20	10	150	1.9±0.20	*1, *2
EMK325 B7475□NHHT			X7R	4.7 μ	±10, ±20	3.5	150	1.9±0.20	*1, *2	
EMK325 B7106□NHTR		16		X7R	10 μ	±10, ±20	10	150	1.9±0.20	*1, *2

▶ 由于篇幅有限, 本产品目录中只记载了有代表性的产品规格, 若考虑使用弊公司产品时, 请确认交货规格说明书中的详细规格。
另外, 有关各产品的详细信息(特性图、可靠性信息、使用时的注意事项等), 请参阅弊公司网站(<http://www.ty-top.com/>)。

■型号一览

多层陶瓷电容器 (温度补偿用)

●063TYPE (Dimension:0.6×0.3mm JIS:0603 EIA:0201)

【温度特性 CG:CG/C0G】厚度 0.3mm (T)

型号1	型号2	额定电压 [V]	温度特性		静电容量 [F]	静电容量允许偏差	Q值 (at 1MHz) (min)	高温负载	厚度*3 [mm]	注释
								额定电压 x %		
UMK063 CG0R5CTHF		50	CG	C0G	0.5 p	±0.25pF	410	200	0.3±0.03	*1,*2
UMK063 CG010CTHF			CG	C0G	1 p	±0.25pF	420	200	0.3±0.03	*1,*2
UMK063 CG1R5CTHF			CG	C0G	1.5 p	±0.25pF	430	200	0.3±0.03	*1,*2
UMK063 CG020CTHF			CG	C0G	2 p	±0.25pF	440	200	0.3±0.03	*1,*2
UMK063 CG030CTHF			CG	C0G	3 p	±0.25pF	460	200	0.3±0.03	*1,*2
UMK063 CG040CTHF			CG	C0G	4 p	±0.25pF	480	200	0.3±0.03	*1,*2
UMK063 CG050CTHF			CG	C0G	5 p	±0.25pF	500	200	0.3±0.03	*1,*2
UMK063 CG060DTHF			CG	C0G	6 p	±0.5pF	520	200	0.3±0.03	*1,*2
UMK063 CG070DTHF			CG	C0G	7 p	±0.5pF	540	200	0.3±0.03	*1,*2
UMK063 CG080DTHF			CG	C0G	8 p	±0.5pF	560	200	0.3±0.03	*1,*2
UMK063 CG090DTHF			CG	C0G	9 p	±0.5pF	580	200	0.3±0.03	*1,*2
UMK063 CG100DTHF			CG	C0G	10 p	±0.5pF	600	200	0.3±0.03	*1,*2
UMK063 CG120JTHF			CG	C0G	12 p	±5%	640	200	0.3±0.03	*1,*2
UMK063 CG150JTHF			CG	C0G	15 p	±5%	700	200	0.3±0.03	*1,*2
UMK063 CG180JTHF			CG	C0G	18 p	±5%	760	200	0.3±0.03	*1,*2
UMK063 CG220JTHF			CG	C0G	22 p	±5%	840	200	0.3±0.03	*1,*2
UMK063 CG270JTHF			CG	C0G	27 p	±5%	940	200	0.3±0.03	*1,*2
UMK063 CG330JTHF			CG	C0G	33 p	±5%	1000	200	0.3±0.03	*1,*2
UMK063 CG390JTHF			CG	C0G	39 p	±5%	1000	200	0.3±0.03	*1,*2
UMK063 CG470JTHF			CG	C0G	47 p	±5%	1000	200	0.3±0.03	*1,*2
UMK063 CG560JTHF			CG	C0G	56 p	±5%	1000	200	0.3±0.03	*1,*2
UMK063 CG680JTHF			CG	C0G	68 p	±5%	1000	200	0.3±0.03	*1,*2
UMK063 CG820JTHF			CG	C0G	82 p	±5%	1000	200	0.3±0.03	*1,*2
UMK063 CG101JTHF			CG	C0G	100 p	±5%	1000	200	0.3±0.03	*1,*2
TMK063 CG121JTHF			25	CG	C0G	120 p	±5%	1000	200	0.3±0.03
TMK063 CG151JTHF		CG		C0G	150 p	±5%	1000	200	0.3±0.03	*1,*2
TMK063 CG181JTHF		CG		C0G	180 p	±5%	1000	200	0.3±0.03	*1,*2
TMK063 CG221JTHF		CG		C0G	220 p	±5%	1000	200	0.3±0.03	*1,*2

●105TYPE (Dimension:1.0×0.5mm JIS:1005 EIA:0402)

【温度特性 CG:CG/C0G】厚度 0.5mm (V)

型号1	型号2	额定电压 [V]	温度特性		静电容量 [F]	静电容量允许偏差	Q值 (at 1MHz) (min)	高温负载	厚度*3 [mm]	注释
								额定电压 x %		
UMK105 CG0R5CVHF		50	CG	C0G	0.5 p	±0.25pF	410	200	0.5±0.05	*1,*2
UMK105 CG010CVHF			CG	C0G	1 p	±0.25pF	420	200	0.5±0.05	*1,*2
UMK105 CG1R5CVHF			CG	C0G	1.5 p	±0.25pF	430	200	0.5±0.05	*1,*2
UMK105 CG020CVHF			CG	C0G	2 p	±0.25pF	440	200	0.5±0.05	*1,*2
UMK105 CG030CVHF			CG	C0G	3 p	±0.25pF	460	200	0.5±0.05	*1,*2
UMK105 CG040CVHF			CG	C0G	4 p	±0.25pF	480	200	0.5±0.05	*1,*2
UMK105 CG050CVHF			CG	C0G	5 p	±0.25pF	500	200	0.5±0.05	*1,*2
UMK105 CG060DVHF			CG	C0G	6 p	±0.5pF	520	200	0.5±0.05	*1,*2
UMK105 CG070DVHF			CG	C0G	7 p	±0.5pF	540	200	0.5±0.05	*1,*2
UMK105 CG080DVHF			CG	C0G	8 p	±0.5pF	560	200	0.5±0.05	*1,*2
UMK105 CG090DVHF			CG	C0G	9 p	±0.5pF	580	200	0.5±0.05	*1,*2
UMK105 CG100DVHF			CG	C0G	10 p	±0.5pF	600	200	0.5±0.05	*1,*2
UMK105 CG120JVHF			CG	C0G	12 p	±5%	640	200	0.5±0.05	*1,*2
UMK105 CG150JVHF			CG	C0G	15 p	±5%	700	200	0.5±0.05	*1,*2
UMK105 CG180JVHF			CG	C0G	18 p	±5%	760	200	0.5±0.05	*1,*2
UMK105 CG220JVHF			CG	C0G	22 p	±5%	840	200	0.5±0.05	*1,*2
UMK105 CG270JVHF			CG	C0G	27 p	±5%	940	200	0.5±0.05	*1,*2
UMK105 CG330JVHF			CG	C0G	33 p	±5%	1000	200	0.5±0.05	*1,*2
UMK105 CG390JVHF			CG	C0G	39 p	±5%	1000	200	0.5±0.05	*1,*2
UMK105 CG470JVHF			CG	C0G	47 p	±5%	1000	200	0.5±0.05	*1,*2
UMK105 CG560JVHF			CG	C0G	56 p	±5%	1000	200	0.5±0.05	*1,*2
UMK105 CG680JVHF			CG	C0G	68 p	±5%	1000	200	0.5±0.05	*1,*2
UMK105 CG820JVHF			CG	C0G	82 p	±5%	1000	200	0.5±0.05	*1,*2
UMK105 CG101JVHF			CG	C0G	100 p	±5%	1000	200	0.5±0.05	*1,*2
UMK105 CG121JVHF			CG	C0G	120 p	±5%	1000	200	0.5±0.05	*1,*2
UMK105 CG151JVHF			CG	C0G	150 p	±5%	1000	200	0.5±0.05	*1,*2
UMK105 CG181JVHF			CG	C0G	180 p	±5%	1000	200	0.5±0.05	*1,*2
UMK105 CG221JVHF			CG	C0G	220 p	±5%	1000	200	0.5±0.05	*1,*2
UMK105 CG271JVHF			CG	C0G	270 p	±5%	1000	200	0.5±0.05	*1,*2
UMK105 CG331JVHF			CG	C0G	330 p	±5%	1000	200	0.5±0.05	*1,*2
UMK105 CG391JVHF			CG	C0G	390 p	±5%	1000	200	0.5±0.05	*1,*2
UMK105 CG471JVHF			CG	C0G	470 p	±5%	1000	200	0.5±0.05	*1,*2
UMK105 CG561JVHF			CG	C0G	560 p	±5%	1000	200	0.5±0.05	*1,*2
UMK105 CG681JVHF			CG	C0G	680 p	±5%	1000	200	0.5±0.05	*1,*2
UMK105 CG821JVHF			CG	C0G	820 p	±5%	1000	200	0.5±0.05	*1,*2
UMK105 CG102JVHF			CG	C0G	1000 p	±5%	1000	200	0.5±0.05	*1,*2

▶ 由于篇幅有限, 本产品目录中只记载了有代表性的产品规格, 若考虑使用弊公司产品时, 请确认交货规格说明书中的详细规格。另外, 有关各产品的详细信息(特性图、可靠性信息、使用时的注意事项等), 请参阅弊网站(<http://www.ty-top.com/>)。

中高耐压多层陶瓷电容器

●107TYPE (Dimension:1.6×0.8mm JIS:1608 EIA:0603)

【温度特性 B7 : X7R, C7 : X7S】厚度 0.8mm (A)

型号1	型号2	额定电压 [V]	温度特性	静电容量 [F]	静电容量允许偏差 [%]	tan δ [%]	高温负载	厚度*3 [mm]	注释
							额定电压 x %		
HMK107 B7102□AHT		100	X7R	1000 p	±10, ±20	3.5	200	0.8±0.10	*1, *2
HMK107 B7152□AHT			X7R	1500 p	±10, ±20	3.5	200	0.8±0.10	*1, *2
HMK107 B7222□AHT			X7R	2200 p	±10, ±20	3.5	200	0.8±0.10	*1, *2
HMK107 B7332□AHT			X7R	3300 p	±10, ±20	3.5	200	0.8±0.10	*1, *2
HMK107 B7472□AHT			X7R	4700 p	±10, ±20	3.5	200	0.8±0.10	*1, *2
HMK107 B7682□AHT			X7R	6800 p	±10, ±20	3.5	200	0.8±0.10	*1, *2
HMK107 B7103□AHT			X7R	0.01 μ	±10, ±20	3.5	200	0.8±0.10	*1, *2
HMK107 B7153□AHT			X7R	0.015 μ	±10, ±20	3.5	200	0.8±0.10	*1, *2
HMK107 B7223□AHT			X7R	0.022 μ	±10, ±20	3.5	200	0.8±0.10	*1, *2
HMK107 B7333□AHT			X7R	0.033 μ	±10, ±20	3.5	200	0.8±0.10	*1, *2
HMK107 B7473□AHT			X7R	0.047 μ	±10, ±20	3.5	200	0.8±0.10	*1, *2
HMK107 B7104□AHT			X7R	0.1 μ	±10, ±20	3.5	200	0.8±0.10	*1, *2
HMK107 C7224□AHT			X7S	0.22 μ	±10, ±20	3.5	150	0.8±0.10	*1, *2

●212TYPE (Dimension:2.0×1.25mm JIS:2012 EIA:0805)

【温度特性 B7 : X7R, C7 : X7S】厚度 1.25mm (G)

型号1	型号2	额定电压 [V]	温度特性	静电容量 [F]	静电容量允许偏差 [%]	tan δ [%]	高温负载	厚度*3 [mm]	注释	
							额定电压 x %			
HMK212 B7103□GHT		100	X7R	0.01 μ	±10, ±20	3.5	200	1.25±0.10	*1, *2	
HMK212 B7153□GHT			X7R	0.015 μ	±10, ±20	3.5	200	1.25±0.10	*1, *2	
HMK212 B7223□GHT			X7R	0.022 μ	±10, ±20	3.5	200	1.25±0.10	*1, *2	
HMK212 B7333□GHT			X7R	0.033 μ	±10, ±20	3.5	200	1.25±0.10	*1, *2	
HMK212 B7473□GHT			X7R	0.047 μ	±10, ±20	3.5	200	1.25±0.10	*1, *2	
HMK212 B7683□GHT			X7R	0.068 μ	±10, ±20	3.5	200	1.25±0.10	*1, *2	
HMK212 B7104□GHT			X7R	0.1 μ	±10, ±20	3.5	200	1.25±0.10	*1, *2	
HMK212 B7224□GHT			X7R	0.22 μ	±10, ±20	3.5	200	1.25±0.10	*1, *2	
HMK212 C7474□GHTE			X7S	0.47 μ	±10, ±20	3.5	150	1.25±0.10	*1, *2	
HMK212BC7105□GHTE			X7S	1 μ	±10, ±20	3.5	150	1.25+0.20/-0	*1, *2	
QMK212 B7472□GHT			250	X7R	4700 p	±10, ±20	2.5	150	1.25±0.10	*1, *2
QMK212 B7682□GHT				X7R	6800 p	±10, ±20	2.5	150	1.25±0.10	*1, *2
QMK212 B7103□GHT				X7R	0.01 μ	±10, ±20	2.5	150	1.25±0.10	*1, *2
QMK212 B7153□GHT				X7R	0.015 μ	±10, ±20	2.5	150	1.25±0.10	*1, *2
QMK212 B7223□GHT		X7R		0.022 μ	±10, ±20	2.5	150	1.25±0.10	*1, *2	

【温度特性 B7 : X7R】厚度 0.85mm (D)

型号1	型号2	额定电压 [V]	温度特性	静电容量 [F]	静电容量允许偏差 [%]	tan δ [%]	高温负载	厚度*3 [mm]	注释
							额定电压 x %		
QMK212 B7102□DHT		250	X7R	1000 p	±10, ±20	2.5	150	0.85±0.10	*1, *2
QMK212 B7152□DHT			X7R	1500 p	±10, ±20	2.5	150	0.85±0.10	*1, *2
QMK212 B7222□DHT			X7R	2200 p	±10, ±20	2.5	150	0.85±0.10	*1, *2
QMK212 B7332□DHT			X7R	3300 p	±10, ±20	2.5	150	0.85±0.10	*1, *2

●316TYPE (Dimension:3.2×1.6mm JIS:3216 EIA:1206)

【温度特性 B7 : X7R, C7 : X7S】厚度 1.6mm (L)

型号1	型号2	额定电压 [V]	温度特性	静电容量 [F]	静电容量允许偏差 [%]	tan δ [%]	高温负载	厚度*3 [mm]	注释	
							额定电压 x %			
HMK316 B7473□LHT		100	X7R	0.047 μ	±10, ±20	3.5	200	1.6±0.20	*1, *2	
HMK316 B7104□LHT			X7R	0.1 μ	±10, ±20	3.5	200	1.6±0.20	*1, *2	
HMK316 B7154□LHT			X7R	0.15 μ	±10, ±20	3.5	200	1.6±0.20	*1, *2	
HMK316 B7224□LHT			X7R	0.22 μ	±10, ±20	3.5	200	1.6±0.20	*1, *2	
HMK316 B7334□LHT			X7R	0.33 μ	±10, ±20	3.5	200	1.6±0.20	*1, *2	
HMK316 B7474□LHT			X7R	0.47 μ	±10, ±20	3.5	200	1.6±0.20	*1, *2	
HMK316 B7105□LHT			X7R	1 μ	±10, ±20	3.5	200	1.6±0.20	*1, *2	
HMK316AC7225□LHTE			X7S	2.2 μ	±10, ±20	3.5	150	1.6±0.20	*1, *2	
QMK316 B7333□LHT			250	X7R	0.033 μ	±10, ±20	2.5	150	1.6±0.20	*1, *2
QMK316 B7473□LHT				X7R	0.047 μ	±10, ±20	2.5	150	1.6±0.20	*1, *2
QMK316 B7683□LHT		X7R		0.068 μ	±10, ±20	2.5	150	1.6±0.20	*1, *2	
QMK316 B7104□LHT		X7R		0.1 μ	±10, ±20	2.5	150	1.6±0.20	*1, *2	
SMK316 B7153□LHT		630	X7R	0.015 μ	±10, ±20	2.5	120	1.6±0.20	*1, *2	
SMK316 B7223□LHT			X7R	0.022 μ	±10, ±20	2.5	120	1.6±0.20	*1, *2	

【温度特性 B7 : X7R】厚度 1.15mm (F)

型号1	型号2	额定电压 [V]	温度特性	静电容量 [F]	静电容量允许偏差 [%]	tan δ [%]	高温负载	厚度*3 [mm]	注释
							额定电压 x %		
SMK316 B7102□FHT		630	X7R	1000 p	±10, ±20	2.5	120	1.15±0.10	*1, *2
SMK316 B7152□FHT			X7R	1500 p	±10, ±20	2.5	120	1.15±0.10	*1, *2
SMK316 B7222□FHT			X7R	2200 p	±10, ±20	2.5	120	1.15±0.10	*1, *2
SMK316 B7332□FHT			X7R	3300 p	±10, ±20	2.5	120	1.15±0.10	*1, *2
SMK316 B7472□FHT			X7R	4700 p	±10, ±20	2.5	120	1.15±0.10	*1, *2
SMK316 B7682□FHT			X7R	6800 p	±10, ±20	2.5	120	1.15±0.10	*1, *2
SMK316 B7103□FHT			X7R	0.01 μ	±10, ±20	2.5	120	1.15±0.10	*1, *2

● 325TYPE (Dimension:3.2×2.5mm JIS:3225 EIA:1210)

【温度特性 B7 : X7R, C7 : X7S】厚度2.5mm (M)

型号1	型号2	额定电压 [V]	温度特性	静电容量 [F]	静电容量允许偏差 [%]	tan δ [%]	高温负载	厚度*3 [mm]	注释
							额定电压 x %		
HMK325 B7225□MHP		100	X7R	2.2 μ	±10, ±20	3.5	200	2.5±0.20	*1, *2
HMK325 C7475□MHPE			X7S	4.7 μ	±10, ±20	3.5	150	2.5±0.20	*1, *2

【温度特性 B7 : X7R】厚度1.9mm (N)

型号1	型号2	额定电压 [V]	温度特性	静电容量 [F]	静电容量允许偏差 [%]	tan δ [%]	高温负载	厚度*3 [mm]	注释
							额定电压 x %		
HMK325 B7224□NHT		100	X7R	0.22 μ	±10, ±20	3.5	200	1.9±0.20	*1, *2
HMK325 B7474□NHT			X7R	0.47 μ	±10, ±20	3.5	200	1.9±0.20	*1, *2
HMK325 B7684□NHT			X7R	0.68 μ	±10, ±20	3.5	200	1.9±0.20	*1, *2
HMK325 B7105□NHT		250	X7R	1 μ	±10, ±20	3.5	200	1.9±0.20	*1, *2
QMK325 B7473□NHT			X7R	0.047 μ	±10, ±20	2.5	150	1.9±0.20	*1, *2
QMK325 B7104□NHT			X7R	0.1 μ	±10, ±20	2.5	150	1.9±0.20	*1, *2
QMK325 B7154□NHT			X7R	0.15 μ	±10, ±20	2.5	150	1.9±0.20	*1, *2
QMK325 B7224□NHT			X7R	0.22 μ	±10, ±20	2.5	150	1.9±0.20	*1, *2
SMK325 B7223□NHT			X7R	0.022 μ	±10, ±20	2.5	120	1.9±0.20	*1, *2
SMK325 B7333□NHT		630	X7R	0.033 μ	±10, ±20	2.5	120	1.9±0.20	*1, *2
SMK325 B7473□NHT			X7R	0.047 μ	±10, ±20	2.5	120	1.9±0.20	*1, *2

【温度特性 B7 : X7R】厚度1.15mm (F)

型号1	型号2	额定电压 [V]	温度特性	静电容量 [F]	静电容量允许偏差 [%]	tan δ [%]	高温负载	厚度*3 [mm]	注释
							额定电压 x %		
HMK325 B7104□FHT		100	X7R	0.1 μ	±10, ±20	3.5	200	1.15±0.10	*1, *2

● 432TYPE (Dimension:4.5×3.2mm JIS:4532 EIA:1812)

【温度特性 B7 : X7R】厚度2.5mm (M)

型号1	型号2	额定电压 [V]	温度特性	静电容量 [F]	静电容量允许偏差 [%]	tan δ [%]	高温负载	厚度*3 [mm]	注释
							额定电压 x %		
HMK432 B7474□MHT		100	X7R	0.47 μ	±10, ±20	3.5	200	2.5±0.20	*1, *2
HMK432 B7105□MHT			X7R	1 μ	±10, ±20	3.5	200	2.5±0.20	*1, *2
HMK432 B7155□MHT			X7R	1.5 μ	±10, ±20	3.5	200	2.5±0.20	*1, *2
HMK432 B7225□MHT			X7R	2.2 μ	±10, ±20	3.5	200	2.5±0.20	*1, *2
QMK432 B7104□MHT		250	X7R	0.1 μ	±10, ±20	2.5	150	2.5±0.20	*1, *2
QMK432 B7224□MHT			X7R	0.22 μ	±10, ±20	2.5	150	2.5±0.20	*1, *2
QMK432 B7334□MHT			X7R	0.33 μ	±10, ±20	2.5	150	2.5±0.20	*1, *2
QMK432 B7474□MHT			X7R	0.47 μ	±10, ±20	2.5	150	2.5±0.20	*1, *2
SMK432 B7473□MHT		630	X7R	0.047 μ	±10, ±20	2.5	120	2.5±0.20	*1, *2
SMK432 B7683□MHT			X7R	0.068 μ	±10, ±20	2.5	120	2.5±0.20	*1, *2
SMK432 B7104□MHT			X7R	0.1 μ	±10, ±20	2.5	120	2.5±0.20	*1, *2

▶ 由于篇幅有限, 本产品目录中只记载了有代表性的产品规格, 若考虑使用弊公司产品时, 请确认交货规格说明书中的详细规格。另外, 有关各产品的详细信息(特性图、可靠性信息、使用时的注意事项等), 请参阅弊司网站(<http://www.ty-top.com/>)。

■型号一览

高频中高压多层陶瓷电容器

●107TYPE (Dimension:1.6×0.8mm JIS:1608 EIA:0603)

【温度特性 CG : CG/C0G】 厚度 0.7mm (C)

型号1	型号2	额定电压 [V]	温度特性		静电容量 [F]	静电容量允许偏差	Q值 (at 1MHz) (min)	高温负载	厚度*3 [mm]	注释
								额定电压 x %		
QVS107 CG0R5□CHT		250	CG	C0G	0.5 p	±0.1pF, ±0.25pF	810	200	0.7±0.10	*2
QVS107 CG0R6□CHT			CG	C0G	0.6 p	±0.1pF, ±0.25pF	812	200	0.7±0.10	*2
QVS107 CG0R7□CHT			CG	C0G	0.7 p	±0.1pF, ±0.25pF	814	200	0.7±0.10	*2
QVS107 CGR75□CHT			CG	C0G	0.75 p	±0.1pF, ±0.25pF	815	200	0.7±0.10	*2
QVS107 CG0R8□CHT			CG	C0G	0.8 p	±0.1pF, ±0.25pF	816	200	0.7±0.10	*2
QVS107 CG0R9□CHT			CG	C0G	0.9 p	±0.1pF, ±0.25pF	818	200	0.7±0.10	*2
QVS107 CG010□CHT			CG	C0G	1 p	±0.1pF, ±0.25pF	820	200	0.7±0.10	*2
QVS107 CG1R1□CHT			CG	C0G	1.1 p	±0.1pF, ±0.25pF	822	200	0.7±0.10	*2
QVS107 CG1R2□CHT			CG	C0G	1.2 p	±0.1pF, ±0.25pF	824	200	0.7±0.10	*2
QVS107 CG1R3□CHT			CG	C0G	1.3 p	±0.1pF, ±0.25pF	826	200	0.7±0.10	*2
QVS107 CG1R5□CHT			CG	C0G	1.5 p	±0.1pF, ±0.25pF	830	200	0.7±0.10	*2
QVS107 CG1R6□CHT			CG	C0G	1.6 p	±0.1pF, ±0.25pF	832	200	0.7±0.10	*2
QVS107 CG1R8□CHT			CG	C0G	1.8 p	±0.1pF, ±0.25pF	836	200	0.7±0.10	*2
QVS107 CG020□CHT			CG	C0G	2 p	±0.1pF, ±0.25pF	840	200	0.7±0.10	*2
QVS107 CG2R2□CHT			CG	C0G	2.2 p	±0.1pF, ±0.25pF	844	200	0.7±0.10	*2
QVS107 CG2R4□CHT			CG	C0G	2.4 p	±0.1pF, ±0.25pF	848	200	0.7±0.10	*2
QVS107 CG2R7□CHT			CG	C0G	2.7 p	±0.1pF, ±0.25pF	854	200	0.7±0.10	*2
QVS107 CG030□CHT			CG	C0G	3 p	±0.1pF, ±0.25pF	860	200	0.7±0.10	*2
QVS107 CG3R3□CHT			CG	C0G	3.3 p	±0.1pF, ±0.25pF	866	200	0.7±0.10	*2
QVS107 CG3R6□CHT			CG	C0G	3.6 p	±0.1pF, ±0.25pF	872	200	0.7±0.10	*2
QVS107 CG3R9□CHT			CG	C0G	3.9 p	±0.1pF, ±0.25pF	878	200	0.7±0.10	*2
QVS107 CG4R3□CHT			CG	C0G	4.3 p	±0.1pF, ±0.25pF	886	200	0.7±0.10	*2
QVS107 CG4R7□CHT			CG	C0G	4.7 p	±0.1pF, ±0.25pF	894	200	0.7±0.10	*2
QVS107 CG5R1□CHT			CG	C0G	5.1 p	±0.25pF, ±0.5pF	902	200	0.7±0.10	*2
QVS107 CG5R6□CHT			CG	C0G	5.6 p	±0.25pF, ±0.5pF	912	200	0.7±0.10	*2
QVS107 CG6R2□CHT			CG	C0G	6.2 p	±0.25pF, ±0.5pF	924	200	0.7±0.10	*2
QVS107 CG6R8□CHT			CG	C0G	6.8 p	±0.25pF, ±0.5pF	936	200	0.7±0.10	*2
QVS107 CG7R5□CHT			CG	C0G	7.5 p	±0.25pF, ±0.5pF	950	200	0.7±0.10	*2
QVS107 CG8R2□CHT			CG	C0G	8.2 p	±0.25pF, ±0.5pF	964	200	0.7±0.10	*2
QVS107 CG100□CHT			CG	C0G	10 p	±2%, ±5%	1000	200	0.7±0.10	*2
QVS107 CG110JCHT			CG	C0G	11 p	±5%	1020	200	0.7±0.10	*2
QVS107 CG120JCHT			CG	C0G	12 p	±5%	1040	200	0.7±0.10	*2
QVS107 CG130JCHT			CG	C0G	13 p	±5%	1060	200	0.7±0.10	*2
QVS107 CG150JCHT			CG	C0G	15 p	±5%	1100	200	0.7±0.10	*2
QVS107 CG160JCHT			CG	C0G	16 p	±5%	1120	200	0.7±0.10	*2
QVS107 CG180JCHT			CG	C0G	18 p	±5%	1160	200	0.7±0.10	*2
QVS107 CG200JCHT			CG	C0G	20 p	±5%	1200	200	0.7±0.10	*2
QVS107 CG220JCHT			CG	C0G	22 p	±5%	1240	200	0.7±0.10	*2
QVS107 CG240JCHT			CG	C0G	24 p	±5%	1280	200	0.7±0.10	*2
QVS107 CG270JCHT			CG	C0G	27 p	±5%	1340	200	0.7±0.10	*2
QVS107 CG300JCHT			CG	C0G	30 p	±5%	1400	200	0.7±0.10	*2
QVS107 CG330JCHT			CG	C0G	33 p	±5%	1400	200	0.7±0.10	*2
QVS107 CG360JCHT			CG	C0G	36 p	±5%	1400	200	0.7±0.10	*2
QVS107 CG390JCHT			CG	C0G	39 p	±5%	1400	200	0.7±0.10	*2
QVS107 CG430JCHT			CG	C0G	43 p	±5%	1400	200	0.7±0.10	*2
QVS107 CG470JCHT			CG	C0G	47 p	±5%	1400	200	0.7±0.10	*2
QVS107 CG510JCHT			CG	C0G	51 p	±5%	1400	200	0.7±0.10	*2
QVS107 CG560JCHT			CG	C0G	56 p	±5%	1400	200	0.7±0.10	*2
QVS107 CG620JCHT			CG	C0G	62 p	±5%	1400	200	0.7±0.10	*2
QVS107 CG680JCHT			CG	C0G	68 p	±5%	1400	200	0.7±0.10	*2
QVS107 CG750JCHT		CG	C0G	75 p	±5%	1400	200	0.7±0.10	*2	
QVS107 CG820JCHT		CG	C0G	82 p	±5%	1400	200	0.7±0.10	*2	
QVS107 CG910JCHT		CG	C0G	91 p	±5%	1400	200	0.7±0.10	*2	
QVS107 CG101JCHT		CG	C0G	100 p	±5%	1400	200	0.7±0.10	*2	

●212TYPE (Dimension:2.0×1.25mm JIS:2012 EIA:0805)

【温度特性 CG : CG/C0G】 厚度 0.85mm (D)

型号1	型号2	额定电压 [V]	温度特性		静电容量 [F]	静电容量允许偏差	Q值 (at 1MHz) (min)	高温负载	厚度*3 [mm]	注释
								额定电压 x %		
QVS212 CG0R5□DHT		250	CG	C0G	0.5 p	±0.1pF, ±0.25pF	810	200	0.85±0.10	*2
QVS212 CG0R6□DHT			CG	C0G	0.6 p	±0.1pF, ±0.25pF	812	200	0.85±0.10	*2
QVS212 CG0R7□DHT			CG	C0G	0.7 p	±0.1pF, ±0.25pF	814	200	0.85±0.10	*2
QVS212 CG0R9□DHT			CG	C0G	0.9 p	±0.1pF, ±0.25pF	818	200	0.85±0.10	*2
QVS212 CG2R2□DHT			CG	C0G	2.2 p	±0.1pF, ±0.25pF	844	200	0.85±0.10	*2
QVS212 CG2R7□DHT			CG	C0G	2.7 p	±0.1pF, ±0.25pF	854	200	0.85±0.10	*2
QVS212 CG3R3□DHT			CG	C0G	3.3 p	±0.1pF, ±0.25pF	866	200	0.85±0.10	*2
QVS212 CG4R7□DHT			CG	C0G	4.7 p	±0.1pF, ±0.25pF	894	200	0.85±0.10	*2
QVS212 CG6R2□DHT			CG	C0G	6.2 p	±0.25pF, ±0.5pF	924	200	0.85±0.10	*2
QVS212 CG8R2□DHT			CG	C0G	8.2 p	±0.25pF, ±0.5pF	964	200	0.85±0.10	*2
QVS212 CG9R1□DHT			CG	C0G	9.1 p	±0.25pF, ±0.5pF	982	200	0.85±0.10	*2
QVS212 CG100JDHT			CG	C0G	10 p	±5%	1000	200	0.85±0.10	*2
QVS212 CG150JDHT			CG	C0G	15 p	±5%	1100	200	0.85±0.10	*2
QVS212 CG180JDHT			CG	C0G	18 p	±5%	1160	200	0.85±0.10	*2
QVS212 CG220JDHT			CG	C0G	22 p	±5%	1240	200	0.85±0.10	*2
QVS212 CG270JDHT			CG	C0G	27 p	±5%	1340	200	0.85±0.10	*2
QVS212 CG300JDHT			CG	C0G	30 p	±5%	1400	200	0.85±0.10	*2
QVS212 CG330JDHT			CG	C0G	33 p	±5%	1400	200	0.85±0.10	*2
QVS212 CG390JDHT			CG	C0G	39 p	±5%	1400	200	0.85±0.10	*2
QVS212 CG470JDHT			CG	C0G	47 p	±5%	1400	200	0.85±0.10	*2
QVS212 CG560JDHT			CG	C0G	56 p	±5%	1400	200	0.85±0.10	*2
QVS212 CG620JDHT			CG	C0G	62 p	±5%	1400	200	0.85±0.10	*2
QVS212 CG101JDHT			CG	C0G	100 p	±5%	1400	200	0.85±0.10	*2

▶ 由于篇幅有限, 本产品目录中只记载了有代表性的产品规格, 若考虑使用弊公司产品时, 请确认交货规格说明书中的详细规格。另外, 有关各产品的详细信息(特性图、可靠性信息、使用时的注意事项等), 请参阅弊公司网站 (<http://www.ty-top.com/>)。

■型号一览

树脂外部电极品多层陶瓷电容器

●107TYPE (Dimension:1.6×0.8mm JIS:1608 EIA:0603)

【温度特性 B7 : X7R】 厚度 0.8mm (A)

型号1	型号2	额定电压 [V]	温度特性	静电容量 [F]	静电容量允许偏差 [%]	tan δ [%]	高温负载	厚度 ^{a)} [mm]	注释	
							额定电压 × %			
TMJ107BB7473□AHT		25	X7R	0.047 μ	±10, ±20	3.5	200	0.8±0.20/-0	*1, *2	
TMJ107BB7104□AHT			X7R	0.1 μ	±10, ±20	3.5	200	0.8±0.20/-0	*1, *2	
TMJ107BB7224□AHT			X7R	0.22 μ	±10, ±20	10	150	0.8±0.20/-0	*1, *2	
TMJ107BB7474□AHT			X7R	0.47 μ	±10, ±20	10	150	0.8±0.20/-0	*1, *2	
TMJ107CB7105□AHR			X7R	1 μ	±10, ±20	10	150	0.8±0.25/-0	*1, *2	
GMJ107BB7473□AHT			X7R	0.047 μ	±10, ±20	3.5	200	0.8±0.20/-0	*1, *2	
GMJ107BB7104□AHT		35	X7R	0.1 μ	±10, ±20	3.5	200	0.8±0.20/-0	*1, *2	
GMJ107BB7224□AHT			X7R	0.22 μ	±10, ±20	10	150	0.8±0.20/-0	*1, *2	
GMJ107BB7473□AHT			X7R	0.47 μ	±10, ±20	10	150	0.8±0.20/-0	*1, *2	
GMJ107CB7105□AHR			X7R	1 μ	±10, ±20	10	150	0.8±0.25/-0	*1, *2	
UMJ107AB7102□AHT			50	X7R	1000 p	±10, ±20	3.5	200	0.8±0.15/-0.05	*1, *2
UMJ107AB7222□AHT				X7R	2200 p	±10, ±20	3.5	200	0.8±0.15/-0.05	*1, *2
UMJ107BB7472□AHT		X7R		4700 p	±10, ±20	3.5	200	0.8±0.20/-0	*1, *2	
UMJ107BB7103□AHT		X7R		0.01 μ	±10, ±20	3.5	200	0.8±0.20/-0	*1, *2	
UMJ107BB7223□AHT		X7R		0.022 μ	±10, ±20	3.5	200	0.8±0.20/-0	*1, *2	
UMJ107BB7473□AHT		X7R		0.047 μ	±10, ±20	3.5	200	0.8±0.20/-0	*1, *2	
UMJ107BB7104□AHT		100	X7R	0.1 μ	±10, ±20	3.5	200	0.8±0.20/-0	*1, *2	
HMJ107AB7102□AHT			X7R	1000 p	±10, ±20	3.5	200	0.8±0.15/-0.05	*1, *2	
HMJ107AB7222□AHT			X7R	2200 p	±10, ±20	3.5	200	0.8±0.15/-0.05	*1, *2	
HMJ107BB7472□AHT			X7R	4700 p	±10, ±20	3.5	200	0.8±0.20/-0	*1, *2	
HMJ107BB7103□AHT			X7R	0.01 μ	±10, ±20	3.5	200	0.8±0.20/-0	*1, *2	
HMJ107BB7223□AHT			X7R	0.022 μ	±10, ±20	3.5	200	0.8±0.20/-0	*1, *2	
HMJ107BB7473□AHT		100	X7R	0.047 μ	±10, ±20	3.5	200	0.8±0.20/-0	*1, *2	
HMJ107BB7104□AHT			X7R	0.1 μ	±10, ±20	3.5	200	0.8±0.20/-0	*1, *2	

●212TYPE (Dimension:2.0×1.25mm JIS:2012 EIA:0805)

【温度特性 B7 : X7R, C7 : X7S】 厚度 0.85mm (D), 厚度 1.25mm (G)

型号1	型号2	额定电压 [V]	温度特性	静电容量 [F]	静电容量允许偏差 [%]	tan δ [%]	高温负载	厚度 ^{a)} [mm]	注释	
							额定电压 × %			
JMJ212CB7106□GHT		6.3	X7R	10 μ	±10, ±20	10	150	1.25±0.25/-0	*1, *2	
EMJ212CB7225□GHT		16	X7R	2.2 μ	±10, ±20	10	150	1.25±0.25/-0	*1, *2	
EMJ212CB7475□GHT			X7R	4.7 μ	±10, ±20	10	150	1.25±0.25/-0	*1, *2	
TMJ212CB7225□GHT		25	X7R	2.2 μ	±10, ±20	10	150	1.25±0.25/-0	*1, *2	
GMJ212CB7105□GHT		35	X7R	1 μ	±10, ±20	10	150	1.25±0.25/-0	*1, *2	
UMJ212BB7103□GHT			X7R	0.01 μ	±10, ±20	2.5	200	1.25±0.20/-0	*1, *2	
UMJ212BB7223□GHT		50	X7R	0.022 μ	±10, ±20	2.5	200	1.25±0.20/-0	*1, *2	
UMJ212BB7473□GHT			X7R	0.047 μ	±10, ±20	3.5	200	1.25±0.20/-0	*1, *2	
UMJ212BB7104□GHT			X7R	0.1 μ	±10, ±20	3.5	200	1.25±0.20/-0	*1, *2	
UMJ212BB7224□GHT			X7R	0.22 μ	±10, ±20	3.5	200	1.25±0.20/-0	*1, *2	
UMJ212CC7474□GHTE			X7S	0.47 μ	±10, ±20	3.5	150	1.25±0.25/-0	*1, *2	
UMJ212CB7105□GHT			X7R	1 μ	±10, ±20	10	150	1.25±0.25/-0	*1, *2	
HMJ212KB7102□DHT		100	X7R	1000 p	±10, ±20	3.5	200	0.85±0.15	*1, *2	
HMJ212KB7222□DHT			X7R	2200 p	±10, ±20	3.5	200	0.85±0.15	*1, *2	
HMJ212BB7472□GHT			X7R	4700 p	±10, ±20	3.5	200	1.25±0.20/-0	*1, *2	
HMJ212BB7103□GHT			X7R	0.01 μ	±10, ±20	3.5	200	1.25±0.20/-0	*1, *2	
HMJ212BB7223□GHT			X7R	0.022 μ	±10, ±20	3.5	200	1.25±0.20/-0	*1, *2	
HMJ212BB7473□GHT			X7R	0.047 μ	±10, ±20	3.5	200	1.25±0.20/-0	*1, *2	
HMJ212BB7104□GHT		100	X7R	0.1 μ	±10, ±20	3.5	200	1.25±0.20/-0	*1, *2	
HMJ212BB7224□GHT			X7R	0.22 μ	±10, ±20	3.5	200	1.25±0.20/-0	*1, *2	
HMJ212CC7474□GHTE			X7S	0.47 μ	±10, ±20	3.5	150	1.25±0.25/-0	*1, *2	
QMJ212KB7102□DHT			250	X7R	1000 p	±10, ±20	2.5	150	0.85±0.15	*1, *2
QMJ212KB7222□DHT				X7R	2200 p	±10, ±20	2.5	150	0.85±0.15	*1, *2
QMJ212BB7472□GHT				X7R	4700 p	±10, ±20	2.5	150	1.25±0.20/-0	*1, *2
QMJ212BB7103□GHT		X7R		0.01 μ	±10, ±20	2.5	150	1.25±0.20/-0	*1, *2	
QMJ212BB7223□GHT		X7R		0.022 μ	±10, ±20	2.5	150	1.25±0.20/-0	*1, *2	
QMJ212BB7473□GHT		X7R		0.047 μ	±10, ±20	2.5	150	1.25±0.20/-0	*1, *2	

●316TYPE (Dimension:3.2×1.6mm JIS:3216 EIA:1206)

【温度特性 B7 : X7R, C7 : X7S】 厚度 1.15mm (F), 厚度 1.6mm (L)

型号1	型号2	额定电压 [V]	温度特性	静电容量 [F]	静电容量允许偏差 [%]	tan δ [%]	高温负载	厚度 ^{a)} [mm]	注释	
							额定电压 × %			
LMJ316BB7226□LHT		10	X7R	22 μ	±10, ±20	10	150	1.6±0.30	*1, *2	
EMJ316BB7475□LHT		16	X7R	4.7 μ	±10, ±20	10	150	1.6±0.30	*1, *2	
EMJ316BB7106□LHT			X7R	10 μ	±10, ±20	10	150	1.6±0.30	*1, *2	
TMJ316BB7474□LHT		25	X7R	0.47 μ	±10, ±20	3.5	200	1.6±0.30	*1, *2	
TMJ316BB7475□LHT			X7R	4.7 μ	±10, ±20	10	150	1.6±0.30	*1, *2	
TMJ316BB7106□LHT			X7R	10 μ	±10, ±20	10	150	1.6±0.30	*1, *2	
GMJ316BB7474□LHT		35	X7R	0.47 μ	±10, ±20	3.5	200	1.6±0.30	*1, *2	
GMJ316AB7225□LHT			X7R	2.2 μ	±10, ±20	10	150	1.6±0.20	*1, *2	
GMJ316BB7475□LHT			X7R	4.7 μ	±10, ±20	10	150	1.6±0.30	*1, *2	
GMJ316BB7106□LHT			X7R	10 μ	±10, ±20	10	150	1.6±0.30	*1, *2	
UMJ316BB7473□LHT			50	X7R	0.047 μ	±10, ±20	3.5	200	1.6±0.30	*1, *2
UMJ316BB7104□LHT				X7R	0.1 μ	±10, ±20	3.5	200	1.6±0.30	*1, *2
UMJ316BB7224□LHT		X7R		0.22 μ	±10, ±20	3.5	200	1.6±0.30	*1, *2	
UMJ316BB7474□LHT		X7R		0.47 μ	±10, ±20	3.5	200	1.6±0.30	*1, *2	
UMJ316BB7105□LHT		X7R		1 μ	±10, ±20	3.5	200	1.6±0.30	*1, *2	
UMJ316AB7225□LHT		X7R		2.2 μ	±10, ±20	10	150	1.6±0.20	*1, *2	
UMJ316BC7475□LHTE			X7S	4.7 μ	±10, ±20	2.5	150	1.6±0.30	*1, *2	

▶ 由于篇幅有限, 本产品目录中只记载了有代表性的产品规格。若考虑使用弊公司产品时, 请确认交货规格说明书中的详细规格。另外, 有关各产品的详细信息(特性图、可靠性信息、使用时的注意事项等), 请参阅弊公司网站(<http://www.ty-top.com/>)。

■ 型号一览

型号1	型号2	额定电压 [V]	温度特性	静电容量 [F]	静电容量允许偏差 [%]	tan δ [%]	高温负载	厚度*3 [mm]	注释	
							额定电压 x %			
HMJ316 B7102□FHT		100	X7R	1000 p	±10, ±20	3.5	200	1.15±0.10	*1, *2	
HMJ316 B7222□FHT			X7R	2200 p	±10, ±20	3.5	200	1.15±0.10	*1, *2	
HMJ316 B7472□FHT			X7R	4700 p	±10, ±20	3.5	200	1.15±0.10	*1, *2	
HMJ316KB7103□FHT			X7R	0.01 μ	±10, ±20	3.5	200	1.15±0.20	*1, *2	
HMJ316BB7223□LHT			X7R	0.022 μ	±10, ±20	3.5	200	1.6±0.30	*1, *2	
HMJ316BB7473□LHT			X7R	0.047 μ	±10, ±20	3.5	200	1.6±0.30	*1, *2	
HMJ316BB7104□LHT			X7R	0.1 μ	±10, ±20	3.5	200	1.6±0.30	*1, *2	
HMJ316BB7224□LHT			X7R	0.22 μ	±10, ±20	3.5	200	1.6±0.30	*1, *2	
HMJ316BB7474□LHT			X7R	0.47 μ	±10, ±20	3.5	200	1.6±0.30	*1, *2	
HMJ316BB7105□LHT			X7R	1 μ	±10, ±20	3.5	200	1.6±0.30	*1, *2	
HMJ316BC7225□LHTE			X7S	2.2 μ	±10, ±20	3.5	150	1.6±0.30	*1, *2	
QMJ316 B7102□FHT			250	X7R	1000 p	±10, ±20	2.5	150	1.15±0.10	*1, *2
QMJ316 B7222□FHT				X7R	2200 p	±10, ±20	2.5	150	1.15±0.10	*1, *2
QMJ316 B7472□FHT				X7R	4700 p	±10, ±20	2.5	150	1.15±0.10	*1, *2
QMJ316KB7103□FHT				X7R	0.01 μ	±10, ±20	2.5	150	1.15±0.20	*1, *2
QMJ316BB7223□LHT				X7R	0.022 μ	±10, ±20	2.5	150	1.6±0.30	*1, *2
QMJ316BB7473□LHT				X7R	0.047 μ	±10, ±20	2.5	150	1.6±0.30	*1, *2
QMJ316BB7104□LHT				X7R	0.1 μ	±10, ±20	2.5	150	1.6±0.30	*1, *2
SMJ316 B7102□FHT		X7R		1000 p	±10, ±20	2.5	120	1.15±0.10	*1, *2	
SMJ316 B7222□FHT		X7R		2200 p	±10, ±20	2.5	120	1.15±0.10	*1, *2	
SMJ316 B7472□FHT		X7R		4700 p	±10, ±20	2.5	120	1.15±0.10	*1, *2	
SMJ316KB7103□FHT		X7R	0.01 μ	±10, ±20	2.5	120	1.15±0.20	*1, *2		
SMJ316BB7223□LHT		X7R	0.022 μ	±10, ±20	2.5	120	1.6±0.30	*1, *2		

● 325TYPE (Dimension:3.2×2.5mm JIS:3225 EIA:1210)

【温度特性 B7 : X7R, C7 : X7S】厚度 1.9mm (N), 厚度 2.5mm (M)

型号1	型号2	额定电压 [V]	温度特性	静电容量 [F]	静电容量允许偏差 [%]	tan δ [%]	高温负载	厚度*3 [mm]	注释	
							额定电压 x %			
JMJ325KB7476□MHHP		6.3	X7R	47 μ	±10, ±20	10	150	2.5±0.30	*1, *2	
EMJ325KB7226□MHHP		16	X7R	22 μ	±10, ±20	10	150	2.5±0.30	*1, *2	
TMJ325AB7475□MHHP		25	X7R	4.7 μ	±10, ±20	5	150	2.5±0.30	*1, *2	
TMJ325KB7106□MHHP			X7R	10 μ	±10, ±20	10	150	2.5±0.30	*1, *2	
GMJ325AB7475□MHHP		35	X7R	4.7 μ	±10, ±20	5	150	2.5±0.30	*1, *2	
GMJ325KB7106□MHHP			X7R	10 μ	±10, ±20	10	150	2.5±0.30	*1, *2	
UMJ325AB7225□MHHP		50	X7R	2.2 μ	±10, ±20	3.5	200	2.5±0.30	*1, *2	
UMJ325AB7475□MHHP			X7R	4.7 μ	±10, ±20	5	150	2.5±0.30	*1, *2	
UMJ325KB7106□MHHP			X7R	10 μ	±10, ±20	10	150	2.5±0.30	*1, *2	
HMJ325 B7223□NHT			100	X7R	0.022 μ	±10, ±20	3.5	200	1.9±0.20	*1, *2
HMJ325 B7473□NHT		X7R		0.047 μ	±10, ±20	3.5	200	1.9±0.20	*1, *2	
HMJ325 B7104□NHT		X7R		0.1 μ	±10, ±20	3.5	200	1.9±0.20	*1, *2	
HMJ325 B7224□NHT		X7R		0.22 μ	±10, ±20	3.5	200	1.9±0.20	*1, *2	
HMJ325 B7474□NHT		X7R		0.47 μ	±10, ±20	3.5	200	1.9±0.20	*1, *2	
HMJ325 B7105□NHT		X7R		1 μ	±10, ±20	3.5	200	1.9±0.20	*1, *2	
HMJ325AB7225□MHHP		X7R		2.2 μ	±10, ±20	3.5	200	2.5±0.30	*1, *2	
HMJ325KC7475□MHPE		X7S		4.7 μ	±10, ±20	3.5	150	2.5±0.30	*1, *2	
QMJ325 B7223□NHT		250		X7R	0.022 μ	±10, ±20	2.5	150	1.9±0.20	*1, *2
QMJ325 B7473□NHT				X7R	0.047 μ	±10, ±20	2.5	150	1.9±0.20	*1, *2
QMJ325 B7104□NHT			X7R	0.1 μ	±10, ±20	2.5	150	1.9±0.20	*1, *2	
QMJ325 B7224□NHT			X7R	0.22 μ	±10, ±20	2.5	150	1.9±0.20	*1, *2	
SMJ325 B7223□NHT		630	X7R	0.022 μ	±10, ±20	2.5	120	1.9±0.20	*1, *2	
SMJ325 B7473□NHT			X7R	0.047 μ	±10, ±20	2.5	120	1.9±0.20	*1, *2	

▶ 由于篇幅有限, 本产品目录中只记载了有代表性的产品规格, 若考虑使用弊公司产品时, 请确认交货规格说明书中的详细规格。
另外, 有关各产品的详细信息(特性图、可靠性信息、使用时的注意事项等), 请参阅弊网站(<http://www.ty-top.com/>)。

■ 型号一览

LW 逆转型多层陶瓷电容 (LWDC™)

● 105TYPE (Dimension:0.52×1.0mm JIS:0510 EIA:0204)

【温度特性 BJ: X5R】 厚度 0.3mm (P)

型号1	型号2	额定电压 [V]	温度特性	静电容量 [F]	静电容量允许偏差 [%]	tan δ [%]	高温负载		厚度*3 [mm]	注释
							额定电压 x %			
TWK105 BJ104MPHF		25	X5R	0.1 μ	±20	5	150		0.3±0.05	*1,*2
EWK105 BJ224MPHF		16	X5R	0.22 μ	±20	10	150		0.3±0.05	*1,*2
LWK105 BJ474MPHF		10	X5R	0.47 μ	±20	10	150		0.3±0.05	*1,*2
AWK105 BJ105MPHF		4	X5R	1 μ	±20	10	150		0.3±0.05	*1,*2

【温度特性 C6: X6S, C7: X7S】 厚度 0.3mm (P)

型号1	型号2	额定电压 [V]	温度特性	静电容量 [F]	静电容量允许偏差 [%]	tan δ [%]	高温负载		厚度*3 [mm]	注释
							额定电压 x %			
EWK105 C6104MPHF		16	X6S	0.1 μ	±20	5	150		0.3±0.05	*1,*2
LWK105 C7104MPHF		10	X7S	0.1 μ	±20	5	150		0.3±0.05	*1,*2
LWK105 C6224MPHF		10	X6S	0.22 μ	±20	10	150		0.3±0.05	*1,*2
JWK105 C7104MPHF		6.3	X7S	0.1 μ	±20	5	150		0.3±0.05	*1,*2
JWK105 C7224MPHF			X7S	0.22 μ	±20	10	150		0.3±0.05	*1,*2
JWK105 C6474MPHF			X6S	0.47 μ	±20	10	150		0.3±0.05	*1,*2
AWK105 C7224MPHF		4	X7S	0.22 μ	±20	10	150		0.3±0.05	*1,*2
AWK105 C6474MPHF			X6S	0.47 μ	±20	10	150		0.3±0.05	*1,*2

● 107TYPE (Dimension:0.8×1.6mm JIS:0816 EIA:0306)

【温度特性 BJ: X5R】 厚度 0.5mm (V)

型号1	型号2	额定电压 [V]	温度特性	静电容量 [F]	静电容量允许偏差 [%]	tan δ [%]	高温负载		厚度*3 [mm]	注释
							额定电压 x %			
LWK107 BJ105MVHT		10	X5R	1 μ	±20	10	150		0.5±0.05	*1,*2
JWK107 BJ225MVHT		6.3	X5R	2.2 μ	±20	10	150		0.5±0.05	*1,*2
JWK107 BJ475MVHT			X5R	4.7 μ	±20	10	150		0.5±0.05	*1,*2

【温度特性 B7: X7R, C6: X6S, C7: X7S】 厚度 0.5mm (V)

型号1	型号2	额定电压 [V]	温度特性	静电容量 [F]	静电容量允许偏差 [%]	tan δ [%]	高温负载		厚度*3 [mm]	注释
							额定电压 x %			
TWK107 B7104MVHT		25	X7R	0.1 μ	±20	5	150		0.5±0.05	*1,*2
EWK107 B7224MVHT		16	X7R	0.22 μ	±20	5	150		0.5±0.05	*1,*2
EWK107 B7474MVHT			X7R	0.47 μ	±20	5	150		0.5±0.05	*1,*2
LWK107 B7474MVHT		10	X7R	0.47 μ	±20	5	150		0.5±0.05	*1,*2
JWK107 C7105MVHT		6.3	X7S	1 μ	±20	10	150		0.5±0.05	*1,*2
AWK107 C6225MVHT		4	X6S	2.2 μ	±20	10	150		0.5±0.05	*1,*2
AWK107 C6475MVHT			X6S	4.7 μ	±20	10	150		0.5±0.05	*1,*2

● 212TYPE (Dimension:1.25×2.0mm JIS:1220 EIA:0508)

【温度特性 BJ: X5R】 厚度 0.85mm (D)

型号1	型号2	额定电压 [V]	温度特性	静电容量 [F]	静电容量允许偏差 [%]	tan δ [%]	高温负载		厚度*3 [mm]	注释
							额定电压 x %			
LWK212 BJ475□DHT		10	X5R	4.7 μ	±10, ±20	10	150		0.85±0.10	*1,*2
JWK212 BJ106MDHT		6.3	X5R	10 μ	±20	10	150		0.85±0.10	*1,*2
AWK212 BJ226MDHT		4	X5R	22 μ	±20	10	150		0.85±0.10	*1,*2

【温度特性 C6: X6S】 厚度 0.85mm (D)

型号1	型号2	额定电压 [V]	温度特性	静电容量 [F]	静电容量允许偏差 [%]	tan δ [%]	高温负载		厚度*3 [mm]	注释
							额定电压 x %			
JWK212 C6475□DHT		6.3	X6S	4.7 μ	±10, ±20	10	150		0.85±0.10	*1,*2

▶ 由于篇幅有限, 本产品目录中只记载了有代表性的产品规格, 若考虑使用弊公司产品时, 请确认交货规格说明书中的详细规格。另外, 有关各产品的详细信息(特性图、可靠性信息、使用时的注意事项等), 请参阅弊公司网站(<http://www.ty-top.com/>)。

- 产品目录中的多层陶瓷电容器全部属于RoHS对应品。
- 请在型号的□中指定静电容量允许偏差代码。
- 产品目录中的多层陶瓷电容器全部属于回流焊对应品。

注)

- 根据使用电路和机器，需要按照相应规格处理。请务必咨询正规销售渠道。
- *1：面向汽车室内用途 (AEC-Q200 Qualified) 的产品。

< **AEC-Q200** : AEC-Q200 qualified >

*1标志的多层陶瓷电容器，已实施代表项目的AEC-Q200对应评价试验。

125°C products: AEC-Q200 Grade1 (已在Grade1的试验条件下评价完毕。)

关于本产品的详细规格和评估测试结果等信息，请咨询官方销售渠道。

此外，订购时请索取产品规格书。

- *3：关于尺寸规格，请参照型号标示法的④外形尺寸、⑤产品尺寸公差、⑥参见产品的厚度、以及标准产品的尺寸。

高可靠用途多层陶瓷电容器

● 105TYPE (Dimension:1.0×0.5mm JIS:1005 EIA:0402)

[温度特性 B7: X7R] 厚度 0.5mm (V)

型号1	型号2	额定电压 [V]	温度特性	静电容量 [F]	静电容量允许偏差 [%]	tan δ [%]	高温负载	厚度*3 [mm]	注释
							额定电压 x %		
UMF105 B7102□VHF		50	X7R	1000 p	±10, ±20	2.5	200	0.5±0.05	*1
UMF105 B7472□VHF			X7R	4700 p	±10, ±20	2.5	150	0.5±0.05	*1
UMF105 B7103□VHF			X7R	0.01 μ	±10, ±20	3.5	150	0.5±0.05	*1
TMF105 B7102□VHF		25	X7R	1000 p	±10, ±20	2.5	200	0.5±0.05	*1
TMF105 B7472□VHF			X7R	4700 p	±10, ±20	2.5	150	0.5±0.05	*1
TMF105 B7103□VHF			X7R	0.01 μ	±10, ±20	3.5	200	0.5±0.05	*1
TMF105 B7223□VHF		16	X7R	0.022 μ	±10, ±20	3.5	150	0.5±0.05	*1
EMF105 B7102□VHF			X7R	1000 p	±10, ±20	2.5	200	0.5±0.05	*1
EMF105 B7472□VHF			X7R	4700 p	±10, ±20	2.5	150	0.5±0.05	*1
EMF105 B7103□VHF		10	X7R	0.01 μ	±10, ±20	3.5	200	0.5±0.05	*1
EMF105 B7223□VHF			X7R	0.022 μ	±10, ±20	3.5	150	0.5±0.05	*1
EMF105 B7104□VHF			X7R	0.1 μ	±10, ±20	5	150	0.5±0.05	*1
LMF105 B7102□VHF		10	X7R	1000 p	±10, ±20	2.5	200	0.5±0.05	*1
LMF105 B7472□VHF			X7R	4700 p	±10, ±20	2.5	150	0.5±0.05	*1
LMF105 B7103□VHF			X7R	0.01 μ	±10, ±20	3.5	200	0.5±0.05	*1
LMF105 B7223□VHF		10	X7R	0.022 μ	±10, ±20	3.5	150	0.5±0.05	*1
LMF105 B7104□VHF			X7R	0.1 μ	±10, ±20	5	200	0.5±0.05	*1

● 107TYPE (Dimension:1.6×0.8mm JIS:1608 EIA:0603)

[温度特性 B7: X7R] 厚度 0.8mm (A)

型号1	型号2	额定电压 [V]	温度特性	静电容量 [F]	静电容量允许偏差 [%]	tan δ [%]	高温负载	厚度*3 [mm]	注释
							额定电压 x %		
UMF107 B7104□AHT		50	X7R	0.1 μ	±10, ±20	3.5	200	0.8±0.10	*1
TMF107 B7104□AHT		25	X7R	0.1 μ	±10, ±20	3.5	200	0.8±0.10	*1
EMF107 B7104□AHT		16	X7R	0.1 μ	±10, ±20	3.5	200	0.8±0.10	*1
EMF107 B7105□AHT			X7R	1 μ	±10, ±20	10	150	0.8±0.10	*1
LMF107 B7104□AHT		10	X7R	0.1 μ	±10, ±20	3.5	200	0.8±0.10	*1
LMF107 B7105□AHT			X7R	1 μ	±10, ±20	10	150	0.8±0.10	*1

● 212TYPE (Dimension:2.0×1.25mm JIS:2012 EIA:0805)

[温度特性 B7: X7R] 厚度 1.25mm (G)

型号1	型号2	额定电压 [V]	温度特性	静电容量 [F]	静电容量允许偏差 [%]	tan δ [%]	高温负载	厚度*3 [mm]	注释
							额定电压 x %		
UMF212 B7473□GHT		50	X7R	0.047 μ	±10, ±20	3.5	200	1.25±0.10	*1
TMF212 B7473□GHT		25	X7R	0.047 μ	±10, ±20	3.5	200	1.25±0.10	*1
EMF212 B7473□GHT		16	X7R	0.047 μ	±10, ±20	3.5	200	1.25±0.10	*1
EMF212AB7475□GHT			X7R	4.7 μ	±10, ±20	10	150	1.25+0.15/-0.05	*1
LMF212 B7473□GHT		10	X7R	0.047 μ	±10, ±20	3.5	200	1.25±0.10	*1
LMF212 B7475□GHT			X7R	4.7 μ	±10, ±20	10	150	1.25±0.10	*1

● 316TYPE (Dimension:3.2×1.6mm JIS:3216 EIA:1206)

[温度特性 B7: X7R] 厚度 1.6mm (L)

型号1	型号2	额定电压 [V]	温度特性	静电容量 [F]	静电容量允许偏差 [%]	tan δ [%]	高温负载	厚度*3 [mm]	注释
							额定电压 x %		
LMF316AB7106□LHT		10	X7R	10 μ	±10, ±20	10	150	1.6±0.20	*1
JMF316AB7106□LHT		6.3	X7R	10 μ	±10, ±20	10	150	1.6±0.20	*1

● 325TYPE (Dimension:3.2×2.5mm JIS:3225 EIA:1210)

[温度特性 B7: X7R] 厚度 2.5mm (M)

型号1	型号2	额定电压 [V]	温度特性	静电容量 [F]	静电容量允许偏差 [%]	tan δ [%]	高温负载	厚度*3 [mm]	注释
							额定电压 x %		
UMF325 B7475□MHP		50	X7R	4.7 μ	±10, ±20	5	150	2.5±0.20	*1
TMF325 B7475□MHP		25	X7R	4.7 μ	±10, ±20	5	150	2.5±0.20	*1
EMF325 B7475□MHP		16	X7R	4.7 μ	±10, ±20	5	150	2.5±0.20	*1
LMF325 B7475□MHP		10	X7R	4.7 μ	±10, ±20	5	150	2.5±0.20	*1

▶ 由于篇幅有限，本产品目录中只记载了有代表性的产品规格，若考虑使用弊公司产品时，请确认交货规格说明书中的详细规格。另外，有关各产品的详细信息(特性图、可靠性信息、使用时的注意事项等)，请参阅弊网站 (<http://www.ty-top.com/>)。

Multilayer Ceramic Capacitors

PACKAGING

① Minimum Quantity

● Taped package

Type(EIA)	Thickness		Standard quantity [pcs]	
	mm	code	Paper tape	Embossed tape
<input type="checkbox"/> MK021(008004)	0.125	K	—	50000
<input type="checkbox"/> VS021(008004)				
<input type="checkbox"/> MK042(01005)	0.2	C, D	—	40000
<input type="checkbox"/> VS042(01005)				
<input type="checkbox"/> MK063(0201)	0.3	P,T	15000	—
<input type="checkbox"/> WK105(0204) ※	0.3	P	10000	—
<input type="checkbox"/> MK105(0402) <input type="checkbox"/> MF105(0402)	0.13	H	—	20000
	0.18	E	—	15000
	0.2	C	20000	—
	0.3	P	15000	—
	0.5	V	10000	—
<input type="checkbox"/> VK105(0402)	0.5	W	10000	—
<input type="checkbox"/> MK107(0603)	0.45	K	4000	—
<input type="checkbox"/> WK107(0306) ※	0.5	V	—	4000
<input type="checkbox"/> MF107(0603)	0.8	A	4000	—
<input type="checkbox"/> VS107(0603)	0.7	C	4000	—
<input type="checkbox"/> MJ107(0603)	0.8	A	3000	3000
<input type="checkbox"/> MK212(0805)	0.45	K	4000	—
<input type="checkbox"/> WK212(0508) ※	0.85	D		
<input type="checkbox"/> MF212(0805)	1.25	G	—	3000
<input type="checkbox"/> VS212(0805)	0.85	D	4000	—
<input type="checkbox"/> MJ212(0805)	0.85	D	4000	—
	1.25	G	—	2000
<input type="checkbox"/> MK316(1206) <input type="checkbox"/> MF316(1206)	0.85	D	4000	—
	1.15	F	—	3000
	1.6	L	—	2000
<input type="checkbox"/> MJ316(1206)	1.15	F	—	3000
	1.6	L	—	2000
<input type="checkbox"/> MK325(1210) <input type="checkbox"/> MF325(1210)	0.85	D	—	2000
	1.15	F		
	1.9	N		
	2.0max.	Y		
<input type="checkbox"/> MJ325(1210)	2.5	M	—	1000
	1.9	N	—	2000
	2.5	M	—	500(T), 1000(P)
<input type="checkbox"/> MK432(1812)	2.5	M	—	500

Note : ※ LW Reverse type.

② Taping material

※No bottom tape for pressed carrier tape

● Card board carrier tape



● Embossed tape



▶ This catalog contains the typical specification only due to the limitation of space. When you consider the purchase of our products, please check our specification. For details of each product (characteristics graph, reliability information, precautions for use, and so on), see our Web site (<http://www.ty-top.com/>).



③ Representative taping dimensions

● Paper Tape (8mm wide)

● Pressed carrier tape (2mm pitch)



Type(EIA)	Chip Cavity		Insertion Pitch F	Tape Thickness	
	A	B		T	T1
□MK063(0201)	0.37	0.67	2.0±0.05	0.45max.	0.42max.
□WK105(0204) ※	0.65	1.15		0.4max.	0.3max.
□MK105(0402) (*1 C)				0.45max.	0.42max.
□MK105(0402) (*1 P)					

Note *1 Thickness, C: 0.2mm ,P: 0.3mm. ※ LW Reverse type.

Unit: mm

● Punched carrier tape (2mm pitch)



Type(EIA)	Chip Cavity		Insertion Pitch F	Tape Thickness
	A	B		T
□MK105 (0402)	0.65	1.15	2.0±0.05	0.8max.
□MF105 (0402)				
□VK105 (0402)				

Unit: mm

● Punched carrier tape (4mm pitch)



▶ This catalog contains the typical specification only due to the limitation of space. When you consider the purchase of our products, please check our specification. For details of each product (characteristics graph, reliability information, precautions for use, and so on), see our Web site (<http://www.ty-top.com/>).

Type(EIA)	Chip Cavity		Insertion Pitch	Tape Thickness	
	A	B		F	T
□MK107(0603) □WK107(0306) ※ □MF107(0603)	1.0	1.8	4.0±0.1	1.1max.	
□MK212(0805) □WK212(0508) ※	1.65	2.4		1.1max.	
□MK316(1206)	2.0	3.6			

Note: Taping size might be different depending on the size of the product. ※ LW Reverse type.

Unit: mm



Type(EIA)	Chip Cavity		Insertion Pitch	Tape Thickness	
	A	B		K	T
□MK021(008004) □VS021(008004)	0.135	0.27	1.0±0.02	0.5max.	0.25max.
□MK042(01005) □VS042(01005)					

Unit: mm



Type(EIA)	Chip Cavity		Insertion Pitch	Tape Thickness	
	A	B		K	T
□MK105(0402)	0.6	1.1	2.0±0.1	0.6max	0.2±0.1
□WK107(0306) ※ □MK212(0805) □MF212(0805)	1.0	1.8	4.0±0.1	1.3max.	0.25±0.1
□MK316(1206) □MF316(1206)	2.0	3.6		3.4max.	0.6max.
□MK325(1210) □MF325(1210)	2.8	3.6			

Note: ※ LW Reverse type.

Unit: mm



Type(EIA)	Chip Cavity		Insertion Pitch	Tape Thickness	
	A	B	F	K	T
□MK325(1210)	3.1	4.0	8.0±0.1	4.0max.	0.6max.
□MK432(1812)	3.7	4.9	8.0±0.1	4.0max.	0.6max.

Unit: mm

④Trailer and Leader



⑤Reel size



A	B	C	D	E	R
$\phi 178 \pm 2.0$	$\phi 50 \text{ min.}$	$\phi 13.0 \pm 0.2$	$\phi 21.0 \pm 0.8$	2.0 ± 0.5	1.0
	T	W			
4mm wide tape	1.5max.	5 ± 1.0			
8mm wide tape	2.5max.	10 ± 1.5			
12mm wide tape	2.5max.	14 ± 1.5			

Unit: mm

⑥Top Tape Strength

The top tape requires a peel-off force of 0.1 to 0.7N in the direction of the arrow as illustrated below.



Multilayer Ceramic Capacitors

RELIABILITY DATA

1. Operating Temperature Range

Specified Value	Temperature Compensating(Class1)	Standard	-55 to +125°C																							
		High Frequency Type																								
	High Permittivity (Class2)																									
			<table border="1"> <thead> <tr> <th></th> <th>Specification</th> <th>Temperature Range</th> </tr> </thead> <tbody> <tr> <td rowspan="2">BJ</td> <td>B</td> <td>-25 to +85°C</td> </tr> <tr> <td>X5R</td> <td>-55 to +85°C</td> </tr> <tr> <td>B7</td> <td>X7R</td> <td>-55 to +125°C</td> </tr> <tr> <td>C6</td> <td>X6S</td> <td>-55 to +105°C</td> </tr> <tr> <td>C7</td> <td>X7S</td> <td>-55 to +125°C</td> </tr> <tr> <td>D7</td> <td>X7T</td> <td>-55 to +125°C</td> </tr> <tr> <td>LD(※)</td> <td>X5R</td> <td>-55 to +85°C</td> </tr> </tbody> </table>		Specification	Temperature Range	BJ	B	-25 to +85°C	X5R	-55 to +85°C	B7	X7R	-55 to +125°C	C6	X6S	-55 to +105°C	C7	X7S	-55 to +125°C	D7	X7T	-55 to +125°C	LD(※)	X5R	-55 to +85°C
	Specification	Temperature Range																								
BJ	B	-25 to +85°C																								
	X5R	-55 to +85°C																								
B7	X7R	-55 to +125°C																								
C6	X6S	-55 to +105°C																								
C7	X7S	-55 to +125°C																								
D7	X7T	-55 to +125°C																								
LD(※)	X5R	-55 to +85°C																								
			Note: ※LD Low distortion high value multilayer ceramic capacitor																							

2. Storage Conditions

Specified Value	Temperature Compensating(Class1)	Standard	-55 to +125°C																							
		High Frequency Type																								
	High Permittivity (Class2)																									
			<table border="1"> <thead> <tr> <th></th> <th>Specification</th> <th>Temperature Range</th> </tr> </thead> <tbody> <tr> <td rowspan="2">BJ</td> <td>B</td> <td>-25 to +85°C</td> </tr> <tr> <td>X5R</td> <td>-55 to +85°C</td> </tr> <tr> <td>B7</td> <td>X7R</td> <td>-55 to +125°C</td> </tr> <tr> <td>C6</td> <td>X6S</td> <td>-55 to +105°C</td> </tr> <tr> <td>C7</td> <td>X7S</td> <td>-55 to +125°C</td> </tr> <tr> <td>D7</td> <td>X7T</td> <td>-55 to +125°C</td> </tr> <tr> <td>LD(※)</td> <td>X5R</td> <td>-55 to +85°C</td> </tr> </tbody> </table>		Specification	Temperature Range	BJ	B	-25 to +85°C	X5R	-55 to +85°C	B7	X7R	-55 to +125°C	C6	X6S	-55 to +105°C	C7	X7S	-55 to +125°C	D7	X7T	-55 to +125°C	LD(※)	X5R	-55 to +85°C
	Specification	Temperature Range																								
BJ	B	-25 to +85°C																								
	X5R	-55 to +85°C																								
B7	X7R	-55 to +125°C																								
C6	X6S	-55 to +105°C																								
C7	X7S	-55 to +125°C																								
D7	X7T	-55 to +125°C																								
LD(※)	X5R	-55 to +85°C																								
			Note: ※LD Low distortion high value multilayer ceramic capacitor																							

3. Rated Voltage

Specified Value	Temperature Compensating(Class1)	Standard	50VDC, 25VDC
		High Frequency Type	50VDC, 25VDC
	High Permittivity (Class2)		50VDC, 35VDC, 25VDC, 16VDC, 10VDC, 6.3VDC, 4VDC, 2.5VDC

4. Withstanding Voltage (Between terminals)

Specified Value	Temperature Compensating(Class1)	Standard	No breakdown or damage
		High Frequency Type	
	High Permittivity (Class2)		
Test Methods and Remarks		Class 1	Class 2
	Applied voltage	Rated volta × 3	Rated voltage × 2.5
	Duration	1 to 5 sec.	
	Charge/discharge current	50mA max.	

5. Insulation Resistance

Specified Value	Temperature Compensating(Class1)	Standard	10000 MΩ min.
		High Frequency Type	
	High Permittivity (Class2) Note 1		C ≤ 0.047 μF : 10000 MΩ min. C > 0.047 μF : 500MΩ · μF
Test Methods and Remarks	Applied voltage	: Rated voltage	
	Duration	: 60 ± 5 sec.	
	Charge/discharge current	: 50mA max.	

▶ This catalog contains the typical specification only due to the limitation of space. When you consider the purchase of our products, please check our specification. For details of each product (characteristics graph, reliability information, precautions for use, and so on), see our Web site (<http://www.ty-top.com/>).

6. Capacitance (Tolerance)				
Specified Value	Temperature Compensating(Class1)	Standard	C□	0.2pF ≤ C ≤ 5pF : ±0.25pF
			U□	0.2pF ≤ C ≤ 10pF : ±0.5pF
			SL	C > 10pF : ±5% or ±10%
		High Frequency Type	CH	0.3pF ≤ C ≤ 2pF : ±0.1pF C > 2pF : ±5%
	High Permittivity (Class2)		BJ, B7, C6, C7, D7, LD(※) : ±10% or ±20% Note: ※LD Low distortion high value multilayer ceramic capacitor	
Test Methods and Remarks			Class 1	
			Standard	High Frequency Type
			Class 2	
			C ≤ 10 μF	C > 10 μF
	Preconditioning		None	
Measuring frequency		Thermal treatment (at 150°C for 1hr) Note 2		
Measuring voltage Note		1MHz ± 10%	1kHz ± 10%	120 ± 10Hz
Measuring voltage Note		0.5 to 5Vrms	1 ± 0.2Vrms	0.5 ± 0.1rms
Bias application		one		

7. Q or Dissipation Factor				
Specified Value	Temperature Compensating(Class1)	Standard	C < 30pF : Q ≥ 400 + 20C C ≥ 30pF : Q ≥ 1000 (C: Nominal capacitance)	
			High Frequency Type	Refer to detailed specification
	High Permittivity (Class2) Note 1		BJ, B7, C6, C7, D7: 2.5% max.	
Test Methods and Remarks			Class 1	
			Standard	High Frequency Type
			Class 2	
			C ≤ 10 μF	C > 10 μF
	Preconditioning		None	
Measuring frequency		Thermal treatment (at 150°C for 1hr) Note 2		
Measuring voltage Note 1		1MHz ± 10%	1GHz	1kHz ± 10%
Measuring voltage Note 1		0.5 to 5Vrms	1 ± 0.2Vrms	0.5 ± 0.1Vrms
Bias application		None		
High Frequency Type Measuring equipment : HP4291A Measuring jig : HP16192A				

8. Temperature Characteristic (Without voltage application)						
Specified Value	Temperature Compensating(Class1)	Standard	Temperature Characteristic [ppm/°C]		Tolerance [ppm/°C]	
			C□ : 0	CG, CH, CJ, CK	G : ±30 H : ±60 J : ±120 K : ±250	
			U□ : -750	UJ, UK		
			SL : +350 to -1000			
		High Frequency Type	Temperature Characteristic [ppm/°C]		Tolerance [ppm/°C]	
			C□ : 0		H : ±60	
	High Permittivity (Class2)		Specification	Capacitance change	Reference temperature	Temperature Range
			B	±10%	20°C	-25 to +85°C
			X5R	±15%	25°C	-55 to +85°C
			X7R	±15%	25°C	-55 to +125°C
			X6S	±22%	25°C	-55 to +105°C
			X7S	±22%	25°C	-55 to +125°C
			X7S	+22/-33%	25°C	-55 to +125°C
			LD(※)	X5R	±15%	25°C
Note : ※LD Low distortion high value multilayer ceramic capacitor						
Test Methods and Remarks	Class 1 Capacitance at 20°C and 85°C shall be measured in thermal equilibrium, and the temperature characteristic shall be calculated from the following equation.					
	$\frac{(C_{85} - C_{20})}{C_{20} \times \Delta T} \times 10^6 \text{ (ppm/°C)} \quad \Delta T = 65$					
	Class 2 Capacitance at each step shall be measured in thermal equilibrium, and the temperature characteristic shall be calculated from the following equation.					
		Step	B	X5R, X7R, X6S, X7S, X7T		
	1	Minimum operating temperature				
	2	20°C	25°C			
	3	Maximum operating temperature				

▶ This catalog contains the typical specification only due to the limitation of space. When you consider the purchase of our products, please check our specification. For details of each product (characteristics graph, reliability information, precautions for use, and so on), see our Web site (<http://www.ty-top.com/>).

	$\frac{(C - C_2)}{C_2} \times 100(\%)$ <p>C : Capacitance in Step 1 or Step 3 C2 : Capacitance in Step 2</p>
--	--

9. Deflection

Specified Value	Temperature Compensating(Class1)	Standard	Appearance : No abnormality Capacitance change : Within $\pm 5\%$ or ± 0.5 pF, whichever is larger.
		High Frequency Type	Appearance : No abnormality Capacitance change : Within ± 0.5 pF
	High Permittivity (Class2)		Appearance : No abnormality Capacitance change : Within $\pm 12.5\%$ (BJ, B7, C6, C7, D7, LD(※)) Note: ※LD Low distortion high value multilayer ceramic capacitor

Test Methods and Remarks	<table border="1"> <tr> <th colspan="2">Multilayer Ceramic Capacitors</th> </tr> <tr> <td>042, 063, ※1105 Type</td> <td>The other types</td> </tr> <tr> <th colspan="2">Glass epoxy-resin substrate</th> </tr> <tr> <td>Thickness</td> <td>0.8mm 1.6mm</td> </tr> <tr> <td>Warp</td> <td>1mm (Soft Termination type:3mm)</td> </tr> <tr> <td>Duration</td> <td>10 sec.</td> </tr> </table> <p>※1:105 Type thickness, C: 0.2mm, P: 0.3mm.</p>	Multilayer Ceramic Capacitors		042, 063, ※1105 Type	The other types	Glass epoxy-resin substrate		Thickness	0.8mm 1.6mm	Warp	1mm (Soft Termination type:3mm)	Duration	10 sec.	<p>(Unit: mm)</p> <p>Capacitance measurement shall be conducted with the board bent</p>
	Multilayer Ceramic Capacitors													
042, 063, ※1105 Type	The other types													
Glass epoxy-resin substrate														
Thickness	0.8mm 1.6mm													
Warp	1mm (Soft Termination type:3mm)													
Duration	10 sec.													

10. Body Strength

Specified Value	Temperature Compensating(Class1)	Standard	—
		High Frequency Type	No mechanical damage.
	High Permittivity (Class2)		—

Test Methods and Remarks	<p>High Frequency Type Applied force : 5N Duration : 10 sec.</p>
--------------------------	--

11. Adhesive Strength of Terminal Electrodes

Specified Value	Temperature Compensating(Class1)	Standard	No terminal separation or its indication.
		High Frequency Type	
	High Permittivity (Class2)		

Test Methods and Remarks	<table border="1"> <tr> <th colspan="2">Multilayer Ceramic Capacitors</th> </tr> <tr> <td>042, 063 Type</td> <td>105 Type or more</td> </tr> <tr> <td>Applied force</td> <td>2N 5N</td> </tr> <tr> <td>Duration</td> <td>30 ± 5 sec.</td> </tr> </table>	Multilayer Ceramic Capacitors		042, 063 Type	105 Type or more	Applied force	2N 5N	Duration	30 ± 5 sec.	
	Multilayer Ceramic Capacitors									
	042, 063 Type	105 Type or more								
Applied force	2N 5N									
Duration	30 ± 5 sec.									

12. Solderability

Specified Value	Temperature Compensating(Class1)	Standard	At least 95% of terminal electrode is covered by new solder.
		High Frequency Type	
	High Permittivity (Class2)		

Test Methods and Remarks		Eutectic solder	Lead-free solder
	Solder type	H60A or H63A	Sn-3.0Ag-0.5Cu
	Solder temperature	230 ± 5°C	245 ± 3°C
	Duration	4 ± 1 sec.	

▶ This catalog contains the typical specification only due to the limitation of space. When you consider the purchase of our products, please check our specification. For details of each product (characteristics graph, reliability information, precautions for use, and so on), see our Web site (<http://www.ty-top.com/>).

13. Resistance to Soldering

Specified Value	Temperature Compensating(Class1)	Standard	Appearance : No abnormality Capacitance change : Within $\pm 2.5\%$ or $\pm 0.25\text{pF}$, whichever is larger. Q : Initial value Insulation resistance : Initial value Withstanding voltage (between terminals) : No abnormality
		High Frequency Type	Appearance : No abnormality Capacitance change : Within $\pm 2.5\%$ Q : Initial value Insulation resistance : Initial value Withstanding voltage (between terminals) : No abnormality
	High Permittivity (Class2) Note 1		Appearance : No abnormality Capacitance change : Within $\pm 7.5\%$ (BJ, B7, C6, C7, D7, LD(※)) Dissipation factor : Initial value Insulation resistance : Initial value Withstanding voltage (between terminals) : No abnormality Note: ※LD Low distortion high value multilayer ceramic capacitor

Test Methods and Remarks	Class 1			
		042, 063 Type	105 Type	
	Preconditioning	None		
	Preheating	150°C, 1 to 2 min.	80 to 100°C, 2 to 5 min. 150 to 200°C, 2 to 5 min.	
	Solder temp.	270 \pm 5°C		
	Duration	3 \pm 0.5 sec.		
	Recovery	6 to 24 hrs (Standard condition) Note 5		
	Class 2			
		042, 063 Type	105, 107, 212 Type	316, 325 Type
	Preconditioning	Thermal treatment (at 150°C for 1 hr) Note 2		
	Preheating	150°C, 1 to 2 min.	80 to 100°C, 2 to 5 min. 150 to 200°C, 2 to 5 min.	80 to 100°C, 5 to 10 min. 150 to 200°C, 5 to 10 min.
	Solder temp.	270 \pm 5°C		
	Duration	3 \pm 0.5 sec.		
	Recovery	24 \pm 2 hrs (Standard condition) Note 5		

14. Temperature Cycle (Thermal Shock)

Specified Value	Temperature Compensating(Class1)	Standard	Appearance : No abnormality Capacitance change : Within $\pm 2.5\%$ or $\pm 0.25\text{pF}$, whichever is larger. Q : Initial value Insulation resistance : Initial value Withstanding voltage (between terminals) : No abnormality
		High Frequency Type	Appearance : No abnormality Capacitance change : Within $\pm 0.25\text{pF}$ Q : Initial value Insulation resistance : Initial value Withstanding voltage (between terminals) : No abnormality
	High Permittivity (Class2) Note 1		Appearance : No abnormality Capacitance change : Within $\pm 7.5\%$ (BJ, B7, C6, C7, D7, LD(※)) Dissipation factor : Initial value Insulation resistance : Initial value Withstanding voltage (between terminals) : No abnormality Note: ※LD Low distortion high value multilayer ceramic capacitor

Test Methods and Remarks	Class 1		Class 2	
	Preconditioning	None	Thermal treatment (at 150°C for 1 hr) Note 2	
	1 cycle	Step	Temperature (°C)	Time (min.)
		1	Minimum operating temperature	30 \pm 3
		2	Normal temperature	2 to 3
		3	Maximum operating temperature	30 \pm 3
4	Normal temperature	2 to 3		
Number of cycles	5 times			
Recovery	6 to 24 hrs (Standard condition) Note 5	24 \pm 2 hrs (Standard condition) Note 5		

▶ This catalog contains the typical specification only due to the limitation of space. When you consider the purchase of our products, please check our specification. For details of each product (characteristics graph, reliability information, precautions for use, and so on), see our Web site (<http://www.ty-top.com/>).

15. Humidity (Steady State)					
Specified Value	Temperature Compensating(Class1)	Standard	Appearance : No abnormality Capacitance change : Within $\pm 5\%$ or $\pm 0.5\text{pF}$, whichever is larger. Q : $C < 10\text{pF} : Q \geq 200 + 10C$ $10 \leq C < 30\text{pF} : Q \geq 275 + 2.5C$ $C \geq 30\text{pF} : Q \geq 350$ (C: Nominal capacitance) Insulation resistance : 1000 M Ω min.		
		High Frequency Type	Appearance : No abnormality Capacitance change : Within $\pm 0.5\text{pF}$, Insulation resistance : 1000 M Ω min.		
	High Permittivity (Class2) Note 1		Appearance : No abnormality Capacitance change : Within $\pm 12.5\%$ (BJ, B7, C6, C7, D7, LD(※)) Dissipation factor : 5.0% max. (BJ, B7, C6, C7, D7, LD(※)) Insulation resistance : 50 M $\Omega\mu\text{F}$ or 1000 M Ω whichever is smaller. Note: ※LD Low distortion high value multilayer ceramic capacitor		
Test Methods and Remarks		Class 1		Class 2	
		Standard	High Frequency Type	All items	
	Preconditioning	None			Thermal treatment (at 150°C for 1 hr) Note 2
	Temperature	40 \pm 2°C	60 \pm 2°C	40 \pm 2°C	
	Humidity	90 to 95%RH		90 to 95%RH	
	Duration	500+24/-0 hrs		500+24/-0 hrs	
	Recovery	6 to 24 hrs (Standard condition) Note 5		24 \pm 2 hrs (Standard condition) Note 5	

16. Humidity Loading					
Specified Value	Temperature Compensating(Class1)	Standard	Appearance : No abnormality Capacitance change : Within $\pm 7.5\%$ or $\pm 0.75\text{pF}$, whichever is larger. Q : $C < 30\text{pF} : Q \geq 100 + 10C/3$ $C \geq 30\text{pF} : Q \geq 200$ (C: Nominal capacitance) Insulation resistance : 500 M Ω min.		
		High Frequency Type	Appearance : No abnormality Capacitance change : $C \leq 2\text{pF} : \text{Within } \pm 0.4 \text{ pF}$ $C > 2\text{pF} : \text{Within } \pm 0.75 \text{ pF}$ (C: Nominal capacitance) Insulation resistance : 500 M Ω min.		
	High Permittivity (Class2) Note 1		Appearance : No abnormality Capacitance change : Within $\pm 12.5\%$ (BJ, B7, C6, C7, D7, LD(※)) Dissipation factor : 5.0% max. (BJ, B7, C6, C7, D7, LD(※)) Insulation resistance : 25 M $\Omega\mu\text{F}$ or 500 M Ω whichever is smaller. Note: ※LD Low distortion high value multilayer ceramic capacitor		
Test Methods and Remarks		Class 1		Class 2	
		Standard	High Frequency Type	All items	
	Preconditioning	None			Voltage treatment (Rated voltage are applied for 1 hour at 40°C) Note 3
	Temperature	40 \pm 2°C	60 \pm 2°C	40 \pm 2°C	
	Humidity	90 to 95%RH		90 to 95%RH	
	Duration	500+24/-0 hrs		500+24/-0 hrs	
	Applied voltage	Rated voltage		Rated voltage	
	Charge/discharge current	50mA max.		50mA max.	
Recovery	6 to 24 hrs (Standard condition) Note 5		24 \pm 2 hrs (Standard condition) Note 5		

► This catalog contains the typical specification only due to the limitation of space. When you consider the purchase of our products, please check our specification.
For details of each product (characteristics graph, reliability information, precautions for use, and so on), see our Web site (<http://www.ty-top.com/>).

17. High Temperature Loading

Specified Value	Temperature Compensating(Class1)	Standard	Appearance : No abnormality Capacitance change : Within $\pm 3\%$ or $\pm 0.3\text{pF}$, whichever is larger. Q : $C < 10\text{pF}$: $Q \geq 200 + 10C$ $10 \leq C < 30\text{pF}$: $Q \geq 275 + 2.5C$ $C \geq 30\text{pF}$: $Q \geq 350$ (C: Nominal capacitance) Insulation resistance : 1000 M Ω min.
		High Frequency Type	Appearance : No abnormality Capacitance change : Within $\pm 3\%$ or $\pm 0.3\text{pF}$, whichever is larger. Insulation resistance : 1000 M Ω min.
	High Permittivity (Class2) Note 1		Appearance : No abnormality Capacitance change : Within $\pm 12.5\%$ (BJ, B7, C6, C7, D7, LD(※)) Dissipation factor : 5.0% max. (BJ, B7, C6, C7, D7, LD(※)) Insulation resistance : 50 M Ω or 1000 M Ω whichever is smaller. Note: ※LD Low distortion high value multilayer ceramic capacitor

Test Methods and Remarks		Class 1		Class 2		
		Standard	High Frequency Type	BJ, LD(※)	C6	B7, C7, D7
	Preconditioning	None		Voltage treatment (Twice the rated voltage shall be applied for 1 hour at 85°C, 105°C or 125°C) Note 3, 4		
	Temperature	Maximum operating temperature		Maximum operating temperature		
	Duration	1000+48/-0 hrs		1000+48/-0 hrs		
	Applied voltage	Rated voltage $\times 2$		Rated voltage $\times 2$ Note 4		
	Charge/discharge current	50mA max.		50mA max.		
	Recovery	6 to 24hr (Standard condition) Note 5		24 ± 2 hrs (Standard condition) Note 5		

Note: ※LD Low distortion high value multilayer ceramic capacitor

Note 1 The figures indicate typical specifications. Please refer to individual specifications in detail.

Note 2 Thermal treatment : Initial value shall be measured after test sample is heat-treated at 150+0/-10°C for an hour and kept at room temperature for 24 ± 2 hours.

Note 3 Voltage treatment : Initial value shall be measured after test sample is voltage-treated for an hour at both the temperature and voltage specified in the test conditions, and kept at room temperature for 24 ± 2 hours.

Note 4 150% of rated voltage is applicable to some items. Please refer to their specifications for further information.

Note 5 Standard condition: Temperature: 5 to 35°C, Relative humidity: 45 to 85 % RH, Air pressure: 86 to 106kPa When there are questions concerning measurement results, in order to provide correlation data, the test shall be conducted under the following condition.
Temperature: 20 ± 2 °C, Relative humidity: 60 to 70 % RH, Air pressure: 86 to 106kPa Unless otherwise specified, all the tests are conducted under the "standard condition".

Medium-High Voltage Multilayer Ceramic Capacitor

RELIABILITY DATA

1. Operating Temperature Range	
Specified Value	Temperature Compensating(High Frequency type) CG(C0G) : -55 to +125°C
	High permittivity X7R, X7S : -55 to +125°C X5 : -55 to +85°C B : -25 to +85°C
2. Storage Temperature Range	
Specified Value	Temperature Compensating(High Frequency type) CG(C0G) : -55 to +125°C
	High permittivity X7R, X7S : -55 to +125°C X5R : -55 to +85°C B : -25 to +85°C
3. Rated Voltage	
Specified Value	100VDC(HMK,HMJ), 250VDC(QMK,QMJ,QVS), 630VDC(SMK,SMJ)
4. Withstanding Voltage (Between terminals)	
Specified Value	No breakdown or damage
Test Methods and Remarks	Applied voltage : Rated voltage × 2.5 (HMK,HMJ), Rated voltage × 2 (QMK,QMJ,QVS), Rated voltage × 1.2 (SMK,SMJ) Duration : 1 to 5sec. Charge/discharge current : 50mA max.
5. Insulation Resistance	
Specified Value	Temperature Compensating(High Frequency type) 10000MΩ min
	High permittivity 100MΩμF or 10GΩ whichever is smaller.
Test Methods and Remarks	Applied voltage : Rated voltage (HMK,HMJ, QMK,QMJ,QVS), 500V (SMK,SMJ) Duration : 60±5sec. Charge/discharge current : 50mA max.
6. Capacitance (Tolerance)	
Specified Value	Temperature Compensating(High Frequency type) ±0.1pF (C<5pF) ±0.25pF (C<10pF) ±0.5pF (5pF≤C<10pF) ±2%(C=10pF) ±5%(C≥10pF)
	High permittivity ±10%, ±20%
Test Methods and Remarks	Temperature Compensating(High Frequency type) Measuring frequency : 1MHz±10% Measuring voltage : 0.5 to 5Vrms Bias application : None
	High permittivity Measuring frequency : 1kHz±10% Measuring voltage : 1±0.2Vrms Bias application : None

▶ This catalog contains the typical specification only due to the limitation of space. When you consider the purchase of our products, please check our specification.
For details of each product (characteristics graph, reliability information, precautions for use, and so on), see our Web site (<http://www.ty-top.com/>).

7. Q or Dissipation Factor	
Specified Value	Temperature Compensating(High Frequency type) $C < 30\text{pF} : Q \geq 800 + 20C$ $C \geq 30\text{pF} : Q \geq 1400$ C:Normal Capacitance(/pF) High permittivity 3.5%max (HMK,HMJ) 2.5%max (QMK,QMJ, SMK,SMJ)
Test Methods and Remarks	Temperature Compensating(High Frequency type) Measuring frequency : 1MHz±10% Measuring voltage : 0.5 to 5Vrms Bas application : None High permittivity Measuring frequency : 1kHz±10% Measuring voltage : 1±0.2Vrms Bas application : None

8. Temperature Characteristic of Capacitance

Specified Value	Temperature Compensating(High Frequency type) C0G : ±30ppm(25 to +125°C) High permittivity B : ±10% (-25 to +85°C) X5R : ±15% (-55 to +85°C) X7R : ±15% (-55 to +125°C) X7S : ±22% (-55 to +125°C)												
Test Methods and Remarks	Temperature Compensating(High Frequency type) Capacitance at 25°C and 85°C shall be measured in thermal equilibrium, and the temperature characteristic shall be calculated from the following equation. $\frac{(C_{85} - C_{25})}{C_{25} \times \Delta T} \times 10^6 \times [\text{ppm}/^\circ\text{C}]$ High permittivity Capacitance value at each step shall be measured in thermal equilibrium, and the temperature characteristic shall be calculated from the following equation. <table border="1" style="margin-left: 20px;"> <thead> <tr> <th>Step</th> <th>B</th> <th>X5R, X7R, X7S</th> </tr> </thead> <tbody> <tr> <td>1</td> <td colspan="2">Minimum operating temperature</td> </tr> <tr> <td>2</td> <td>20°C</td> <td>25°C</td> </tr> <tr> <td>3</td> <td colspan="2">Maximum operating temperature</td> </tr> </tbody> </table> $\frac{(C - C_2)}{C_2} \times 100 (\%)$ C : Capacitance value in Step 1 or Step 3 C2 : Capacitance value in Step 2	Step	B	X5R, X7R, X7S	1	Minimum operating temperature		2	20°C	25°C	3	Maximum operating temperature	
Step	B	X5R, X7R, X7S											
1	Minimum operating temperature												
2	20°C	25°C											
3	Maximum operating temperature												

9. Deflection

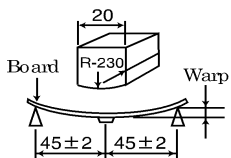
Specified Value	Temperature Compensating(High Frequency type) Appearance : No abnormality Capacitance change : ±5% or ±0.5pF, whichever is larger. High permittivity Appearance : No abnormality Capacitance change : Within ±10%
Test Methods and Remarks	Warp : 1mm (Soft Termination type:3mm) Duration : 10sec. Test board : Glass epoxy-resin substrate Thicknss : 1.6mm <div style="text-align: center;">  <p>(Unit: mm)</p> </div> Capacitance measurement shall be conducted with the board bent.

▶ This catalog contains the typical specification only due to the limitation of space. When you consider the purchase of our products, please check our specification. For details of each product (characteristics graph, reliability information, precautions for use, and so on), see our Web site (<http://www.ty-top.com/>).

10. Adhesive Strength of Terminal Electrodes

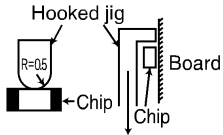
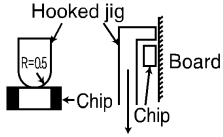
Specified Value	No terminal separation or its indication.
Test Methods and Remarks	Temperature Compensating(High Frequency type) Applied force : 2N Duration : 10±5sec. 
	High permittivity Applied force : 5N Duration : 30±5sec. 

11. Solderability

Specified Value	At least 95% of terminal electrode is covered by new solder		
Test Methods and Remarks		Eutectic solder	Lead-free solder
	Solder type	H60A or H63A	Sn-3.0Ag-0.5Cu
	Solder temperature	230±5°C	245±3°C
	Duration	4±1 sec.	

12. Resistance to Soldering

Specified Value	Temperature Compensating(High Frequency type) Appearance : No abnormality Capacitance change : C※ ≤ 10pF : ±0.25pF C※ > 10pF : ±2.5% ※Normal capacitance Insulation resistance : Initial value Withstanding voltage (between terminals) : No abnormality
	High permittivity Appearance : No abnormality Capacitance change : Within ±15% (HMK, HMJ), ±10% (QMK, QMJ, SMK, SMJ) Dissipation factor : Initial value Insulation resistance : Initial value Withstanding voltage (between terminals) : No abnormality
Test Methods and Remarks	Preconditioning : Thermal treatment (at 150°C for 1hr) Note1 (Only High permittivity) Solder temperature : 270±5°C Duration : 3±0.5sec. Preheating conditions : 80 to 100°C, 2 to 5 min. 150 to 200°C, 2 to 5 min. Recovery : 24±2hrs under the standard condition Note3

13. Temperature Cycle (Thermal Shock)

Specified Value	Temperature Compensating(High Frequency type) Appearance : No abnormality Capacitance change : C※ ≤ 10pF : ±0.25% C※ > 10pF : ±2.5% Insulation resistance : Initial value Withstanding voltage (between terminals) : No abnormality														
	High permittivity Appearance : No abnormality Capacitance change : Within ±15% (HMK, HMJ), ±7.5% (QMK, QMJ, SMK, SMJ) Dissipation factor : Initial value Insulation resistance : Initial value Withstanding voltage (between terminals) : No abnormality														
Test Methods and Remarks	Preconditioning : Thermal treatment (at 150°C for 1hr) Note1 Conditions for 1 cycle														
	<table border="1" data-bbox="288 1776 1126 1921"> <thead> <tr> <th>Step</th> <th>temperature (°C)</th> <th>Time (min.)</th> </tr> </thead> <tbody> <tr> <td>1</td> <td>Minimum operating temperature</td> <td>30±3min.</td> </tr> <tr> <td>2</td> <td>Normal temperature</td> <td>2 to 3min.</td> </tr> <tr> <td>3</td> <td>Maximum operating temperature</td> <td>30±3min.</td> </tr> <tr> <td>4</td> <td>Normal temperature</td> <td>2 to 3min.</td> </tr> </tbody> </table> Number of cycles : 5 times Recovery : 24±2hrs under the standard condition Note3	Step	temperature (°C)	Time (min.)	1	Minimum operating temperature	30±3min.	2	Normal temperature	2 to 3min.	3	Maximum operating temperature	30±3min.	4	Normal temperature
Step	temperature (°C)	Time (min.)													
1	Minimum operating temperature	30±3min.													
2	Normal temperature	2 to 3min.													
3	Maximum operating temperature	30±3min.													
4	Normal temperature	2 to 3min.													

▶ This catalog contains the typical specification only due to the limitation of space. When you consider the purchase of our products, please check our specification. For details of each product (characteristics graph, reliability information, precautions for use, and so on), see our Web site (<http://www.ty-top.com/>).

14. Humidity (Steady state)	
Specified Value	Temperature Compensating(High Frequency type) Appearance : No abnormality Capacitance change : C※ ≤ 10pF : ±0.5pF C※ > 10pF : ±5% ※Normal capacitance Insulation resistance : 1000M Ωmin
	High permittivity Appearance : No abnormality Capacitance change : Within ±15% Dissipation factor : 7%max (HMK, HMJ), 5%max (QMK, QMJ, SMK, SMJ). Insulation resistance : 25M ΩμF or 1000M Ω whichever is smaller.
Test Methods and Remarks	Preconditioning : Thermal treatment (at 150°C for 1hr) Note1 (Only High permittivity) Temperature : 40 ± 2°C Humidity : 90 to 95%RH Duration : 500 +24/ -0 hrs Recovery : 24 ± 2hrs under the standard condition Note3

15. Humidity Loading	
Specified Value	Temperature Compensating(High Frequency type) Appearance : No abnormality Capacitance change : C※ ≤ 2.0pF : ±0.4pF 2.0pF < C ≤ 10pF : ±0.75pF C※ > 10pF : ±7.5% : ※Normal capacitance Insulation resistance : 500M Ωmin
	High permittivity Appearance : No abnormality Capacitance change : Within ±15% Dissipation factor : 7%max (HMK, HMJ), 5%max (QMK, QMJ, SMK, SMJ). Insulation resistance : 10M ΩμF or 500M Ω whichever is smaller.
Test Methods and Remarks	According to JIS 5102 clause 9.9. Preconditioning : Voltage treatment Note2 (Only High permittivity) Temperature : 40 ± 2°C Humidity : 90 to 95%RH Applied voltage : Rated voltage Charge/discharge current : 50mA max. Duration : 500 +24/ -0 hrs Recovery : 24 ± 2hrs under the standard condition Note3

16. High Temperature Loading	
Specified Value	Temperature Compensating(High Frequency type) Appearance : No abnormality Capacitance change : C※ ≤ 10pF : ±0.3pF C※ > 10pF : ±3% Insulation resistance : 1000M Ωmin
	High permittivity Appearance : No abnormality Capacitance change : Within ±15% Dissipation factor : 7%max (HMK, HMJ), 5%max (QMK, QMJ, SMK, SMJ). Insulation resistance : 50M ΩμF or 1000M Ω whichever is smaller.
Test Methods and Remarks	According to JIS 5102 clause 9.10. Preconditioning : Voltage treatment Note2 (Only High permittivity) Temperature : Maximum operating temperature Applied voltage : Rated voltage × 2 (HMK, HMJ, QVS) Rated voltage × 1.5 (QMK, QMJ) Rated voltage × 1.2 (SMK, SMJ) Charge/discharge current : 50mA max. Duration : 1000 +24/ -0 hrs Recovery : 24 ± 2hrs under the standard condition Note3

Note1 Thermal treatment : Initial value shall be measured after test sample is heat-treated at 150+0/ -10°C for an hour and kept at room temperature for 24 ± 2hours.

Note2 Voltage treatment : Initial value shall be measured after test sample is voltage-treated for an hour at both the temperature and voltage specified in the test conditions, and kept at room temperature for 24 ± 2hours.

Note3 Standard condition : Temperature: 5 to 35°C, Relative humidity: 45 to 85 % RH, Air pressure: 86 to 106kPa
When there are questions concerning measurement results, in order to provide correlation data, the test shall be conducted under the following condition.

Temperature: 20 ± 2°C, Relative humidity: 60 to 70 % RH, Air pressure: 86 to 106kPa
Unless otherwise specified, all the tests are conducted under the "standard condition".

Precautions on the use of Multilayer Ceramic Capacitors

PRECAUTIONS

1. Circuit Design

- Precautions**
- ◆ Verification of operating environment, electrical rating and performance
 1. A malfunction of equipment in fields such as medical, aerospace, nuclear control, etc. may cause serious harm to human life or have severe social ramifications. Therefore, any capacitors to be used in such equipment may require higher safety and reliability, and shall be clearly differentiated from them used in general purpose applications.
 - ◆ Operating Voltage (Verification of Rated voltage)
 1. The operating voltage for capacitors must always be their rated voltage or less.
 - If an AC voltage is loaded on a DC voltage, the sum of the two peak voltages shall be the rated voltage or less.
 - For a circuit where an AC or a pulse voltage may be used, the sum of their peak voltages shall also be the rated voltage or less.
 2. Even if an applied voltage is the rated voltage or less reliability of capacitors may be deteriorated in case that either a high frequency AC voltage or a pulse voltage having rapid rise time is used in a circuit.

2. PCB Design

- Precautions**
- ◆ Pattern configurations (Design of Land-patterns)
 1. When capacitors are mounted on PCBs, the amount of solder used (size of fillet) can directly affect the capacitor performance. Therefore, the following items must be carefully considered in the design of land patterns:
 - (1) Excessive solder applied can cause mechanical stresses which lead to chip breaking or cracking. Therefore, please consider appropriate land-patterns for proper amount of solder.
 - (2) When more than one component are jointly soldered onto the same land, each component's soldering point shall be separated by solder-resist.
 - ◆ Pattern configurations (Capacitor layout on PCBs)
 After capacitors are mounted on boards, they can be subjected to mechanical stresses in subsequent manufacturing processes (PCB cutting, board inspection, mounting of additional parts, assembly into the chassis, wave soldering of the boards, etc.). For this reason, land pattern configurations and positions of capacitors shall be carefully considered to minimize stresses.

- Technical considerations**
- ◆ Pattern configurations (Design of Land-patterns)
 The following diagrams and tables show some examples of recommended land patterns to prevent excessive solder amounts.
 - (1) Recommended land dimensions for typical chip capacitors
 - Multilayer Ceramic Capacitors : Recommended land dimensions (unit: mm)
 - Wave-soldering

Type	107	212	316	325
Size	L	1.6	2.0	3.2
	W	0.8	1.25	2.5
A	0.8 to 1.0	1.0 to 1.4	1.8 to 2.5	1.8 to 2.5
B	0.5 to 0.8	0.8 to 1.5	0.8 to 1.7	0.8 to 1.7
C	0.6 to 0.8	0.9 to 1.2	1.2 to 1.6	1.8 to 2.5

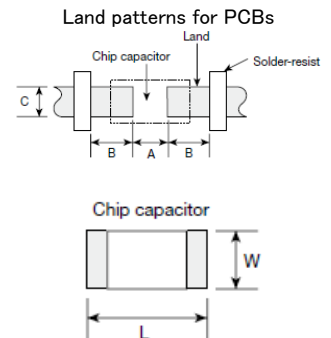

Reflow-soldering

Type	042	063	105	107	212	316	325	432
Size	L	0.4	0.6	1.0	1.6	2.0	3.2	4.5
	W	0.2	0.3	0.5	0.8	1.25	1.6	3.2
A	0.15 to 0.25	0.20 to 0.30	0.45 to 0.55	0.8 to 1.0	0.8 to 1.2	1.8 to 2.5	1.8 to 2.5	2.5 to 3.5
B	0.15 to 0.20	0.20 to 0.30	0.40 to 0.50	0.6 to 0.8	0.8 to 1.2	1.0 to 1.5	1.0 to 1.5	1.5 to 1.8
C	0.15 to 0.30	0.25 to 0.40	0.45 to 0.55	0.6 to 0.8	0.9 to 1.6	1.2 to 2.0	1.8 to 3.2	2.3 to 3.5

Note: Recommended land size might be different according to the allowance of the size of the product.

- LWDC: Recommended land dimensions for reflow-soldering (unit: mm)

Type	105	107	212
Size	L	0.52	0.8
	W	1.0	2.0
A	0.18 to 0.22	0.25 to 0.3	0.5 to 0.7
B	0.2 to 0.25	0.3 to 0.4	0.4 to 0.5
C	0.9 to 1.1	1.5 to 1.7	1.9 to 2.1

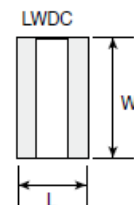

(2) Examples of good and bad solder application

Items	Not recommended	Recommended
Mixed mounting of SMD and leaded components		
Component placement close to the chassis		
Hand-soldering of leaded components near mounted components		
Horizontal component placement		

◆ Pattern configurations (Capacitor layout on PCBs)

1-1. The following is examples of good and bad capacitor layouts ; capacitors shall be located to minimize any possible mechanical stresses from board warp or deflection.

Items	Not recommended	Recommended
Deflection of board		 Place the product at a right angle to the direction of the anticipated mechanical stress.

1-2. The amount of mechanical stresses given will vary depending on capacitor layout. Please refer to diagram below.

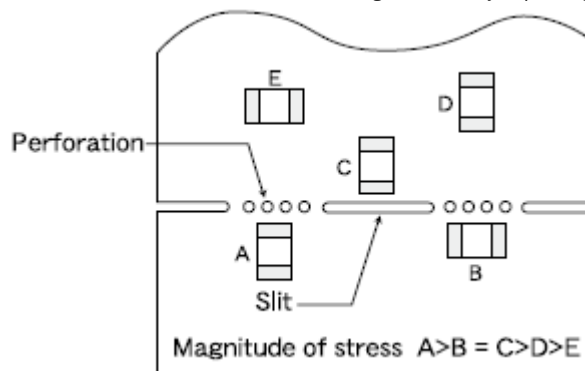

1-3. When PCB is split, the amount of mechanical stress on the capacitors can vary according to the method used. The following methods are listed in order from least stressful to most stressful: push-back, slit, V-grooving, and perforation. Thus, please consider the PCB, split methods as well as chip location.

3. Mounting

Precautions	<p>◆ Adjustment of mounting machine</p> <ol style="list-style-type: none"> When capacitors are mounted on PCB, excessive impact load shall not be imposed on them. Maintenance and inspection of mounting machines shall be conducted periodically. <p>◆ Selection of Adhesives</p> <ol style="list-style-type: none"> When chips are attached on PCBs with adhesives prior to soldering, it may cause capacitor characteristics degradation unless the following factors are appropriately checked : size of land patterns, type of adhesive, amount applied, hardening temperature and hardening period. Therefore, please contact us for further information.
Technical considerations	<p>◆ Adjustment of mounting machine</p> <ol style="list-style-type: none"> When the bottom dead center of a pick-up nozzle is too low, excessive force is imposed on capacitors and causes damages. To avoid this, the following points shall be considerable. <ol style="list-style-type: none"> The bottom dead center of the pick-up nozzle shall be adjusted to the surface level of PCB without the board deflection. The pressure of nozzle shall be adjusted between 1 and 3 N static loads. To reduce the amount of deflection of the board caused by impact of the pick-up nozzle, supporting pins or back-up pins shall be used on the other side of the PCB. The following diagrams show some typical examples of good and bad pick-up nozzle placement:

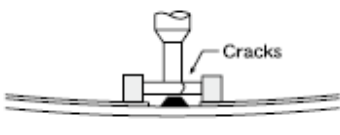
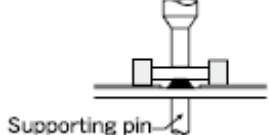
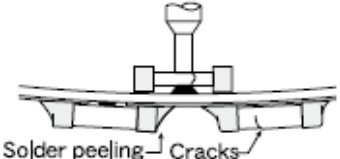
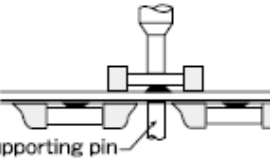
Items	Not recommended	Recommended
Single-sided mounting		
Double-sided mounting		

2. As the alignment pin is worn out, adjustment of the nozzle height can cause chipping or cracking of capacitors because of mechanical impact on the capacitors.
To avoid this, the monitoring of the width between the alignment pins in the stopped position, maintenance, check and replacement of the pin shall be conducted periodically.

◆ Selection of Adhesives

Some adhesives may cause IR deterioration. The different shrinkage percentage of between the adhesive and the capacitors may result in stresses on the capacitors and lead to cracking. Moreover, too little or too much adhesive applied to the board may adversely affect components. Therefore, the following precautions shall be noted in the application of adhesives.

(1) Required adhesive characteristics

- The adhesive shall be strong enough to hold parts on the board during the mounting & solder process.
- The adhesive shall have sufficient strength at high temperatures.
- The adhesive shall have good coating and thickness consistency.
- The adhesive shall be used during its prescribed shelf life.
- The adhesive shall harden rapidly.
- The adhesive shall have corrosion resistance.
- The adhesive shall have excellent insulation characteristics.
- The adhesive shall have no emission of toxic gasses and no effect on the human body.

(2) The recommended amount of adhesives is as follows;

[Recommended condition]

Figure	212/316 case sizes as examples
a	0.3mm min
b	100 to 120 μ m
c	Adhesives shall not contact land

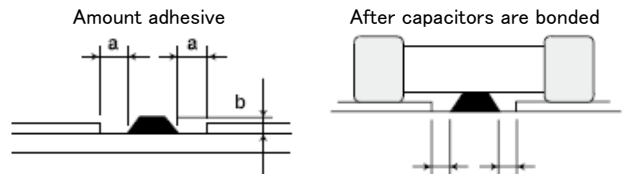

4. Soldering

◆ Selection of Flux

Since flux may have a significant effect on the performance of capacitors, it is necessary to verify the following conditions prior to use;

- Flux used shall be less than or equal to 0.1 wt% (in Cl equivalent) of halogenated content. Flux having a strong acidity content shall not be applied.
- When shall capacitors are soldered on boards, the amount of flux applied shall be controlled at the optimum level.
- When water-soluble flux is used, special care shall be taken to properly clean the boards.

Precautions

◆ Soldering

Temperature, time, amount of solder, etc. shall be set in accordance with their recommended conditions.
Sn-Zn solder paste can adversely affect MLCC reliability.
Please contact us prior to usage of Sn-Zn solder.

◆ Selection of Flux

- When too much halogenated substance (Chlorine, etc.) content is used to activate flux, or highly acidic flux is used, it may lead to corrosion of terminal electrodes or degradation of insulation resistance on the surfaces of the capacitors.
- Flux is used to increase solderability in wave soldering. However if too much flux is applied, a large amount of flux gas may be emitted and may adversely affect the solderability. To minimize the amount of flux applied, it is recommended to use a flux-bubbling system.
- Since the residue of water-soluble flux is easily dissolved in moisture in the air, the residues on the surfaces of capacitors in high humidity conditions may cause a degradation of insulation resistance and reliability of the capacitors. Therefore, the cleaning methods and the capability of the machines used shall also be considered carefully when water-soluble flux is used.

Technical considerations

◆ Soldering

- Ceramic chip capacitors are susceptible to thermal shock when exposed to rapid or concentrated heating or rapid cooling.
- Therefore, the soldering must be conducted with great care so as to prevent malfunction of the components due to excessive thermal shock.
- Preheating : Capacitors shall be preheated sufficiently, and the temperature difference between the capacitors and solder shall be within 100 to 130°C.
- Cooling : The temperature difference between the capacitors and cleaning process shall not be greater than 100°C.

* This catalog contains the typical specification only due to the limitation of space. When you consider the purchase of our products, please check our specification.
For details of each product (characteristics graph, reliability information, precautions for use, and so on), see our Web site (<http://www.ty-top.com/>).

[Reflow soldering]

【Recommended conditions for eutectic soldering】

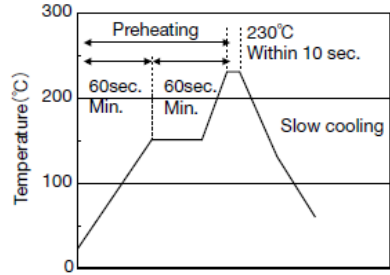

【Recommended condition for Pb-free soldering】

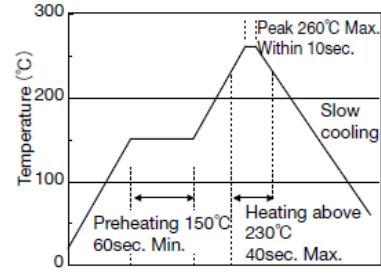

Caution

- ① The ideal condition is to have solder mass (fillet) controlled to 1/2 to 1/3 of the thickness of a capacitor.
- ② Because excessive dwell times can adversely affect solderability, soldering duration shall be kept as close to recommended times as possible.
- ③ Allowable number of reflow soldering : 2 times max.

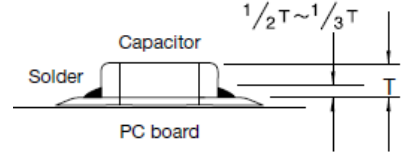

[Wave soldering]

【Recommended conditions for eutectic soldering】

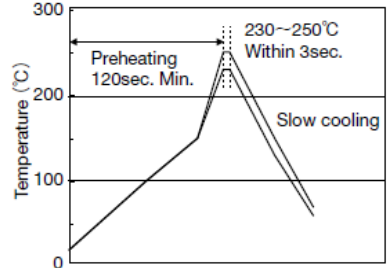

【Recommended condition for Pb-free soldering】

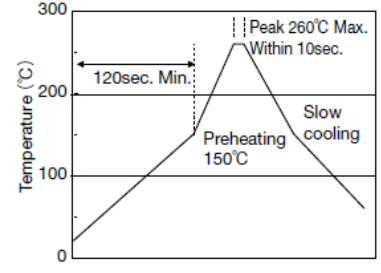

Caution

- ① Wave soldering must not be applied to capacitors designated as for reflow soldering only.
- ② Allowable number of wave soldering : 1 times max.

[Hand soldering]

【Recommended conditions for eutectic soldering】

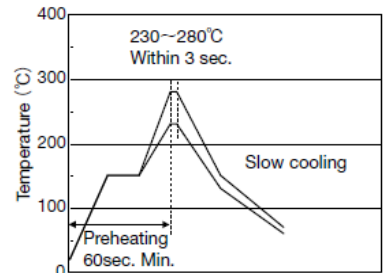

【Recommended condition for Pb-free soldering】

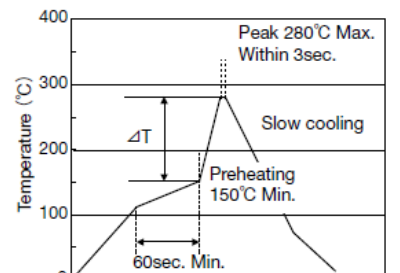
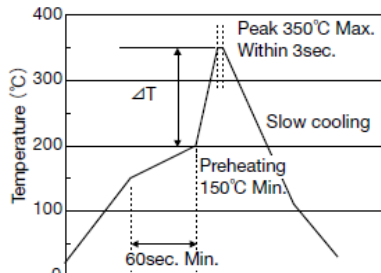

Caution

- ① Use a 50W soldering iron with a maximum tip diameter of 1.0 mm.
- ② The soldering iron shall not directly touch capacitors.
- ③ Allowable number of hand soldering : 1 times max.

316type or less	$\Delta T \leq 150^{\circ}\text{C}$
-----------------	-------------------------------------

325type or more	$\Delta T \leq 130^{\circ}\text{C}$
-----------------	-------------------------------------

5. Cleaning

Precautions	<p>◆Cleaning conditions</p> <ol style="list-style-type: none"> 1. When PCBs are cleaned after capacitors mounting, please select the appropriate cleaning solution in accordance with the intended use of the cleaning. (e.g. to remove soldering flux or other materials from the production process.) 2. Cleaning condition shall be determined after it is verified by using actual cleaning machine that the cleaning process does not affect capacitor's characteristics.
Technical considerations	<ol style="list-style-type: none"> 1. The use of inappropriate cleaning solutions can cause foreign substances such as flux residue to adhere to capacitors or deteriorate their outer coating, resulting in a degradation of the capacitor's electrical properties (especially insulation resistance). 2. Inappropriate cleaning conditions (insufficient or excessive cleaning) may adversely affect the performance of the capacitors. In the case of ultrasonic cleaning, too much power output can cause excessive vibration of PCBs which may lead to the cracking of capacitors or the soldered portion, or decrease the terminal electrodes' strength. Therefore, the following conditions shall be carefully checked; <ul style="list-style-type: none"> Ultrasonic output : 20 W/l or less Ultrasonic frequency : 40 kHz or less Ultrasonic washing period : 5 min. or less

▶ This catalog contains the typical specification only due to the limitation of space. When you consider the purchase of our products, please check our specification. For details of each product (characteristics graph, reliability information, precautions for use, and so on), see our Web site (<http://www.ty-top.com/>).

6. Resin coating and mold	
Precautions	<p>1. With some type of resins, decomposition gas or chemical reaction vapor may remain inside the resin during the hardening period or while left under normal storage conditions resulting in the deterioration of the capacitor's performance.</p> <p>2. When a resin's hardening temperature is higher than capacitor's operating temperature, the stresses generated by the excessive heat may lead to damage or destruction of capacitors. The use of such resins, molding materials etc. is not recommended.</p>
7. Handling	
Precautions	<p>◆Splitting of PCB</p> <p>1. When PCBs are split after components mounting, care shall be taken so as not to give any stresses of deflection or twisting to the board.</p> <p>2. Board separation shall not be done manually, but by using the appropriate devices.</p> <p>◆Mechanical considerations</p> <p>Be careful not to subject capacitors to excessive mechanical shocks.</p> <p>(1) If ceramic capacitors are dropped onto a floor or a hard surface, they shall not be used.</p> <p>(2) Please be careful that the mounted components do not come in contact with or bump against other boards or components.</p>
8. Storage conditions	
Precautions	<p>◆Storage</p> <p>1. To maintain the solderability of terminal electrodes and to keep packaging materials in good condition, care must be taken to control temperature and humidity in the storage area. Humidity should especially be kept as low as possible.</p> <p>•Recommended conditions</p> <p>Ambient temperature : Below 30°C Humidity : Below 70% RH</p> <p>The ambient temperature must be kept below 40°C. Even under ideal storage conditions, solderability of capacitor is deteriorated as time passes, so capacitors shall be used within 6 months from the time of delivery.</p> <p>•Ceramic chip capacitors shall be kept where no chlorine or sulfur exists in the air.</p> <p>2. The capacitance values of high dielectric constant capacitors will gradually decrease with the passage of time, so care shall be taken to design circuits. Even if capacitance value decreases as time passes, it will get back to the initial value by a heat treatment at 150°C for 1hour.</p>
Technical considerations	<p>If capacitors are stored in a high temperature and humidity environment, it might rapidly cause poor solderability due to terminal oxidation and quality loss of taping/packaging materials. For this reason, capacitors shall be used within 6 months from the time of delivery. If exceeding the above period, please check solderability before using the capacitors.</p>
<p>※RCR-2335B (Safety Application Guide for fixed ceramic capacitors for use in electronic equipment) is published by JEITA. Please check the guide regarding precautions for deflection test, soldering by spot heat, and so on.</p>	

High Reliability Application Multilayer Ceramic Capacitors

RELIABILITY DATA

1. Operating Temperature Range	
Specified Value	X7R(−55°C to +125°C)
Test Methods and Remarks	Continuous use is available in this range. (reference temperature : 25°C)
2.Highest Operating temperature Range	
Specified Value	X7R(−55°C to +125°C)
Test Methods and Remarks	Maximum ambient temperature at which capacitors can be continuously used with rated voltage applied.
3. Rated Voltage	
Specified Value	Please refer to the page of the "PART NUMBERS".
Test Methods and Remarks	Continuous maximum applied voltage. If an AC voltage is loaded on a DC voltage, the sum of the two peak voltages should be lower than the rated voltage of the capacitor.
4. Shape and Dimensions	
Specified Value	Please refer to the page of the "EXTERNAL DIMENSIONS".
5. Heat Treatment (Class II)	
Test Methods and Remarks	Initial value shall be measured after test sample is heat-treated at 150+0/−10°C for an hour and kept at room temperature for 24 ± 2 hours.
6. Voltage Treatment (Class II)	
Test Methods and Remarks	Initial value shall be measured after test sample is voltage-treated for an hour at temperature and voltage which are specified as test conditions, and kept at room temperature for 24 ± 2 hours.
7. Dielectric Withstanding Voltage (between terminals)	
Specified Value	No abnormality.
Test Methods and Remarks	Applied voltage : Rated voltage × 2.5 Duration : 1 to 5 seconds. Charging and discharging current shall be 50mA max.
8. Insulation Resistance	
Specified Value	Larger than whichever smaller of 500 MΩ·μF or 10 ⁴ MΩ
Test Methods and Remarks	Applied voltage : Rated voltage Duration : 60±5 seconds. Charging and discharging current shall be 50mA max.
9. Capacitance and Tolerance	
Specified Value	Please refer to the page of the "PART NUMBERS".
Test Methods and Remarks	Measurement frequency : 1kHz±10% (C≤10 μF) Measurement voltage : 1±0.2Vrms (C≤10 μF) 0.5±0.1V (6.3V rated voltage) Heat treatment specified in No.5 of the specification shall be conducted prior to measurement.
10. Q or Dissipation factor (tan δ)	
Specified Value	Please refer to the page of the "PART NUMBERS".
Test Methods and Remarks	Measurement frequency : 1kHz±10% (C≤10 μF) Measurement voltage : 1±0.2Vrms (C≤10 μF) 0.5±0.1V (6.3V rated voltage) Heat treatment specified in No.5 of the specification shall be conducted prior to measurement. NO DC bias is applied.

▶ This catalog contains the typical specification only due to the limitation of space. When you consider the purchase of our products, please check our specification. For details of each product (characteristics graph, reliability information, precautions for use, and so on), see our Web site (<http://www.ty-top.com/>).

11. Temperature Characteristic (without DC bias)													
Specified Value	X7R(−55°C to +125°C) : ±15%												
Test Methods and Remarks	Confirming to EIA RS-198-D (1991) Heat treatment specified in No.5 of the specification shall be conducted prior to measurement. Change of the maximum capacitance deviation in step 1 to 5.												
	<table border="1"> <thead> <tr> <th>step</th> <th>Temperature(°C)</th> </tr> </thead> <tbody> <tr> <td>1</td> <td>+25</td> </tr> <tr> <td>2</td> <td>Minimum operating temperature</td> </tr> <tr> <td>3</td> <td>+25</td> </tr> <tr> <td>4</td> <td>Maximum operating temperature</td> </tr> <tr> <td>5</td> <td>+25</td> </tr> </tbody> </table>	step	Temperature(°C)	1	+25	2	Minimum operating temperature	3	+25	4	Maximum operating temperature	5	+25
	step	Temperature(°C)											
	1	+25											
	2	Minimum operating temperature											
	3	+25											
4	Maximum operating temperature												
5	+25												

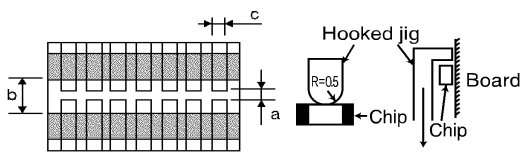
12. Adhesive Force of Terminal Electrodes																									
Specified Value	Appearance: Terminal electrodes shall be no exfoliation or a sign of exfoliation.																								
Test Methods and Remarks	Solder lands refer to fig.1.																								
	<table border="1"> <thead> <tr> <th></th> <th>1608 size</th> <th>larger than 2012 size</th> </tr> </thead> <tbody> <tr> <td>Applying force</td> <td>5N</td> <td>10N</td> </tr> <tr> <td>Duration</td> <td colspan="2">30 ± 5 seconds.</td> </tr> <tr> <td>Board</td> <td colspan="2">Glass epoxy-resin substrate</td> </tr> <tr> <td>Thickness</td> <td colspan="2">1.6mm</td> </tr> </tbody> </table>		1608 size	larger than 2012 size	Applying force	5N	10N	Duration	30 ± 5 seconds.		Board	Glass epoxy-resin substrate		Thickness	1.6mm										
		1608 size	larger than 2012 size																						
	Applying force	5N	10N																						
	Duration	30 ± 5 seconds.																							
	Board	Glass epoxy-resin substrate																							
Thickness	1.6mm																								
																									
	<table border="1"> <thead> <tr> <th rowspan="2">Dimension</th> <th colspan="4">Case size</th> </tr> <tr> <th>1608</th> <th>2012</th> <th>3216</th> <th>3225</th> </tr> </thead> <tbody> <tr> <td>a</td> <td>1.0</td> <td>1.2</td> <td>2.2</td> <td>2.2</td> </tr> <tr> <td>b</td> <td>3.0</td> <td>4.0</td> <td>5.0</td> <td>5.0</td> </tr> <tr> <td>c</td> <td>1.2</td> <td>1.65</td> <td>2.0</td> <td>2.9</td> </tr> </tbody> </table>	Dimension	Case size				1608	2012	3216	3225	a	1.0	1.2	2.2	2.2	b	3.0	4.0	5.0	5.0	c	1.2	1.65	2.0	2.9
Dimension	Case size																								
	1608	2012	3216	3225																					
a	1.0	1.2	2.2	2.2																					
b	3.0	4.0	5.0	5.0																					
c	1.2	1.65	2.0	2.9																					
	Fig.1																								

13. Vibration	
Specified Value	Appearance : No abnormality Capacitance change : Initial value shall be satisfied. Dissipation factor : Initial value shall be satisfied. Insulation resistance : Initial value shall be satisfied.
Test Methods and Remarks	Heat treatment specified in No.5 of the specification shall be conducted prior to test. Measurement shall be conducted after test sample is heat treated as specified in No.5.
	Solder lands refer to figure 1.
	Direction of the vibration test : X, Y, Z each of 3 orientations for 2 hours respectively (total 6 hours)
	Vibration frequency : 10 to 55 to 10Hz (1 minutes each)
	Total amplitude : 1.5 mm
	Measurement after the test shall be made after test sample is kept at room temperature for 24 ± 2 hours.

14. Resistance to Soldering Heat	
Specified Value	Appearance : No abnormality Capacitance change : ≤ ± 7.5% Dissipation factor : Initial value shall be satisfied. Insulation resistance : Initial value shall be satisfied. Dielectric withstanding voltage (between terminals) : No abnormality
Test Methods and Remarks	Heat treatment specified in No.5 of the specification shall be conducted prior to test.
	Immerse test sample in an solder solution (Sn-3Ag-0.5Cu).
	Soldering temperature : 270°C ± 5°C
	Duration : 3 ± 0.5 seconds
	Soaking position : Test sample is soaked until the terminal electrode is covered in solder solution.
	Preheating condition : 3216 size or smaller size: 120 to 150°C for 1 minute, 3225 size: 100 to 120°C for 1 minute, 170 to 200°C for 1 minute.
Measurement after the test shall be made after test sample is kept at room temperature for 24 ± 2 hours.	

15. Solderability	
Specified Value	More than 95% of terminal electrode shall be covered with fresh solder.
Test Methods and Remarks	Heat treatment specified in No.5 of the specification shall be conducted prior to test.
	Immerse test sample in an solder solution (Sn-3Ag-0.5Cu).
	Soldering temperature : 245°C ± 5°C
	Duration : 4 ± 1 seconds
	Dipping position : Test sample is immersed until the terminal electrode is covered in solder solution.

▶ This catalog contains the typical specification only due to the limitation of space. When you consider the purchase of our products, please check our specification.
For details of each product (characteristics graph, reliability information, precautions for use, and so on), see our Web site (<http://www.ty-top.com/>).

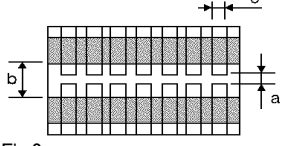
16. Thermal shock																																					
Specified Value	Appearance : No abnormality Capacitance change : $\leq \pm 7.5\%$ Dissipation factor : Initial value shall be satisfied. Insulation resistance : Initial value shall be satisfied. Dielectric withstanding voltage (between terminals) : No abnormality																																				
Test Methods and Remarks	Heat treatment specified in No.5 of the specification shall be conducted prior to test. Measurement shall be conducted after test sample is heat treated as specified in No.5. condition of the one cycle (Air—Air) <table border="1"> <thead> <tr> <th>Step</th> <th>Temperature (°C)</th> <th>Time (min.)</th> <th>Transfer time</th> </tr> </thead> <tbody> <tr> <td>1</td> <td>Minimum usage temperature</td> <td>15</td> <td>within 20 seconds</td> </tr> <tr> <td>2</td> <td>Maximum usage temperature</td> <td>15</td> <td>within 20 seconds</td> </tr> </tbody> </table> Test cycles: 100 times. Measurement after the test shall be made after test sample is kept at room temperature for 24 ± 2 hours. <div style="display: flex; align-items: center;">  <table border="1" style="margin-left: 20px;"> <thead> <tr> <th rowspan="2">Dimension</th> <th colspan="4">Case size</th> </tr> <tr> <th>1608</th> <th>2012</th> <th>3216</th> <th>3225</th> </tr> </thead> <tbody> <tr> <td>a</td> <td>0.6</td> <td>0.8</td> <td>2.0</td> <td>2.0</td> </tr> <tr> <td>b</td> <td>2.2</td> <td>3.0</td> <td>4.4</td> <td>4.4</td> </tr> <tr> <td>c</td> <td>0.9</td> <td>1.3</td> <td>1.7</td> <td>2.6</td> </tr> </tbody> </table> </div>	Step	Temperature (°C)	Time (min.)	Transfer time	1	Minimum usage temperature	15	within 20 seconds	2	Maximum usage temperature	15	within 20 seconds	Dimension	Case size				1608	2012	3216	3225	a	0.6	0.8	2.0	2.0	b	2.2	3.0	4.4	4.4	c	0.9	1.3	1.7	2.6
Step	Temperature (°C)	Time (min.)	Transfer time																																		
1	Minimum usage temperature	15	within 20 seconds																																		
2	Maximum usage temperature	15	within 20 seconds																																		
Dimension	Case size																																				
	1608	2012	3216	3225																																	
a	0.6	0.8	2.0	2.0																																	
b	2.2	3.0	4.4	4.4																																	
c	0.9	1.3	1.7	2.6																																	

17. Humidity Loading	
Specified Value Note1	Appearance : No abnormality Capacitance change : $\pm 12.5\%$ Dissipation factor : 5.0%max. Insulation resistance : Larger than whichever smaller of $25M\Omega \cdot \mu F$ or $500M\Omega$
Test Methods and Remarks	Test condition : $85^\circ C/85\%RH$. Duration : $1000 +48/-0$ hours. DC bias : Applied rated voltage. Voltage treatment specified in No.6 of the specification shall be conducted prior to test. Measurement after the test shall be made after test sample is kept at room temperature for 24 ± 2 hours.

18. High Temperature Loading	
Specified Value Note1	Appearance : No abnormality Capacitance change : $\leq \pm 12.5\%$ Dissipation factor : 5.0%max. Insulation resistance : Larger than whichever smaller of $25M\Omega \cdot \mu F$ or $500M\Omega$
Test Methods and Remarks	Voltage treatment specified in No.6 of the specification shall be conducted prior to test. Test sample shall be put in thermostatic oven with maximum temperature. Applied voltage : Rated voltage x 2 Duration : $1000 +48/-0$ hours. Charging and discharging current shall be 50mA or less. Measurement after the test shall be made after test sample is kept at room temperature for 24 ± 2 hours.

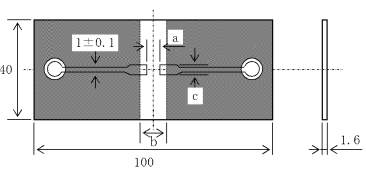
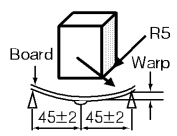
19. Resistance to Flexure of substrate																									
Specified Value	Appearance : No abnormality Capacitance change : $\leq \pm 12.5\%$ Dissipation factor : 5.0%max. Insulation resistance : Initial value shall be satisfied.																								
Test Methods and Remarks	Warp : 1mm Testing board : Grass epoxy - resin substrate Thickness : 1.6mm Test board and solder lands : Refer to fig. 3. <div style="display: flex; align-items: center;">  <table border="1" style="margin-left: 20px;"> <thead> <tr> <th rowspan="2">Dimension</th> <th colspan="4">Case size</th> </tr> <tr> <th>1608</th> <th>2012</th> <th>3216</th> <th>3225</th> </tr> </thead> <tbody> <tr> <td>a</td> <td>0.6</td> <td>0.8</td> <td>2.0</td> <td>2.0</td> </tr> <tr> <td>b</td> <td>2.2</td> <td>3.0</td> <td>4.4</td> <td>4.4</td> </tr> <tr> <td>c</td> <td>0.9</td> <td>1.3</td> <td>1.7</td> <td>2.6</td> </tr> </tbody> </table>  </div>	Dimension	Case size				1608	2012	3216	3225	a	0.6	0.8	2.0	2.0	b	2.2	3.0	4.4	4.4	c	0.9	1.3	1.7	2.6
Dimension	Case size																								
	1608	2012	3216	3225																					
a	0.6	0.8	2.0	2.0																					
b	2.2	3.0	4.4	4.4																					
c	0.9	1.3	1.7	2.6																					
Measurement shall be made with board in the bent position. (fig.4)																									

▶ This catalog contains the typical specification only due to the limitation of space. When you consider the purchase of our products, please check our specification. For details of each product (characteristics graph, reliability information, precautions for use, and so on), see our Web site (<http://www.ty-top.com/>).

20. High Temperature Exposure

Specified Value Note1	Appearance	: No abnormality
	Capacitance change	: $\leq \pm 12.5\%$
	Dissipation factor	: 5.0%max.
	Insulation resistance	: Larger than whichever smaller of 500M Ω · μ F or 10000M Ω

Test Methods and Remarks
 Heat treatment specified in No.5 of the specification shall be conducted prior to test.
 Test sample shall be put in thermostatic oven with maximum temperature.
 Duration : 1000 +48/−0 hours.
 Initial value shall be measured after test sample is heat-treated specified No.5.
 Measurement after the test shall be made after test sample is kept at room temperature for 24 ±2 hours.

21. Temperature Cycling

Specified Value Note1	Appearance	: No abnormality
	Capacitance change	: $\leq \pm 7.5\%$
	Dissipation factor	: Initial value shall be satisfied
	Insulation resistance	: Initial value shall be satisfied

Test Methods and Remarks
 Heat treatment specified in No.5 of the specification shall be conducted prior to test.
 Measurement shall be conducted after test sample is heat treated as specified in No.5.
 condition of the one cycle

Step	Temperature (°C)	Time (min.)
1	Minimum usage temperature	30 ± 3
2	+25	2 to 3
3	Maximum usage temperature	30 ± 3
4	+25	2 to 3

Test cycles: 200 times
 Solder lands refer to fig. 2.
 Measurement after the test shall be made after test sample is kept at room temperature for 24 ±2 hours.

22. Body strength

Specified Value	No mechanical damage
-----------------	----------------------

Test Methods and Remarks

Applying force : 10N
 Applying time : 10 seconds

The diagram illustrates the body strength test setup. On the left, a 3D perspective view of a rectangular chip is shown with length L and width W, where L is greater than or equal to W. On the right, a cross-sectional view shows the chip being pressed by a hemispherical pressing jig with a radius R=0.5. The contact width between the jig and the chip is 0.6L. The entire assembly is supported by a base, and the process is labeled as 'Pressurization'.

Note 1 The figures indicate typical specifications. Please refer to individual specifications in detail.

Precautions on the use of High Reliability Application Multilayer Ceramic Capacitors

PRECAUTIONS

1. Circuit Design

- Precautions**
- ◆ Verification of operating environment, electrical rating and performance
 1. A malfunction in medical equipment, spacecraft, nuclear reactors, etc. may cause serious harm to human life or have severe social ramifications.
As such, any capacitors to be used in such equipment may require higher safety and/or reliability considerations and should be clearly differentiated from components used in general purpose applications.
 - ◆ Operating Voltage (Verification of Rated voltage)
 1. The operating voltage for capacitors must always be lower than their rated values.
If an AC voltage is loaded on a DC voltage, the sum of the two peak voltages should be lower than the rated value of the capacitor chosen. For a circuit where both an AC and a pulse voltage may be present, the sum of their peak voltages should also be lower than the capacitor's rated voltage.
 2. Even if the applied voltage is lower than the rated value, the reliability of capacitors might be reduced if either a high frequency AC voltage or a pulse voltage having rapid rise time is present in the circuit.

2. PCB Design

- Precautions**
- ◆ Pattern configurations (Design of Land-patterns)
 1. When capacitors are mounted on a PCB, the amount of solder used (size of fillet) can directly affect capacitor performance. Therefore, the following items must be carefully considered in the design of solder land patterns:
 - (1) The amount of solder applied can affect the ability of chips to withstand mechanical stresses which may lead to breaking or cracking. Therefore, when designing land-patterns it is necessary to consider the appropriate size and configuration of the solder pads which in turn determines the amount of solder necessary to form the fillets.
 - (2) When more than one part is jointly soldered onto the same land or pad, the pad must be designed so that each component's soldering point is separated by solder-resist.
 - ◆ Pattern configurations (Capacitor layout on panelized [breakaway] PC boards)
 1. After capacitors have been mounted on the boards, chips can be subjected to mechanical stresses in subsequent manufacturing processes (PCB cutting, board inspection, mounting of additional parts, assembly into the chassis, wave soldering the reflow soldered boards etc.) For this reason, planning pattern configurations and the position of SMD capacitors should be carefully performed to minimize stress.

- Technical considerations**
- ◆ Pattern configurations (Design of Land-patterns)
 1. The following diagrams and tables show some examples of recommended patterns to prevent excessive solder amounts. (larger fillets which extend above the component end terminations) Examples of improper pattern designs are also shown.
 - (1) Recommended land dimensions for a typical chip capacitor land patterns for PCBs

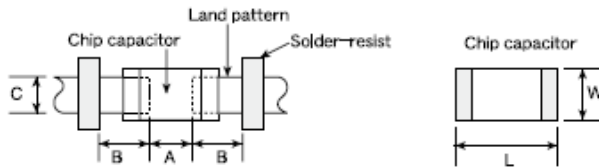

Recommended land dimensions for reflow-soldering (unit: mm)

Type		107	212	316	325
Size	L	1.6	2.0	3.2	3.2
	W	0.8	1.25	1.6	2.5
	A	0.8~1.0	0.8~1.2	1.8~2.5	1.8~2.5
	B	0.6~0.8	0.8~1.2	1.0~1.5	1.0~1.5
	C	0.6~0.8	0.9~1.6	1.2~2.0	1.8~3.2

Excess solder can affect the ability of chips to withstand mechanical stresses. Therefore, please take proper precautions when designing land-patterns.

(2) Examples of good and bad solder application

Items	Not recommended	Recommended
Mixed mounting of SMD and leaded components	Lead wire of component	Solder-resist
Component placement close to the chassis	Chassis Solder (for grounding) Electrode pattern	Solder-resist
Hand-soldering of leaded components near mounted components	Lead wire of component Soldering iron	Solder-resist
Horizontal component placement		Solder-resist

◆ Pattern configurations (Capacitor layout on panelized [breakaway] PC boards)

1-1. The following is examples of good and bad capacitor layout; SMD capacitors should be located to minimize any possible mechanical stresses from board warp or deflection.

Items	Not recommended	Recommended
Deflection of the board		Place the product at a right angle to the direction of the anticipated mechanical stress.

1-2. To layout the capacitors for the breakaway PC board, it should be noted that the amount of mechanical stresses given will vary depending on capacitor layout. The example below shows recommendations for better design.

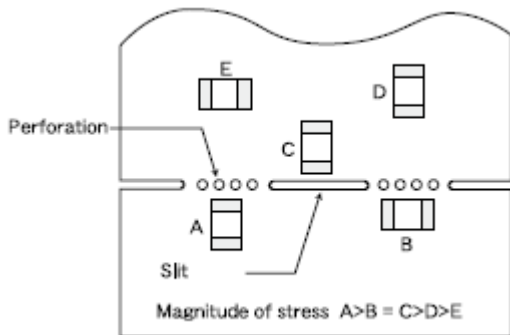

1-3. When breaking PC boards along their perforations, the amount of mechanical stress on the capacitors can vary according to the method used. The following methods are listed in order from least stressful to most stressful: push-back, slit, V-grooving, and perforation. Thus, any ideal SMD capacitor layout must also consider the PCB splitting procedure.

Precautions

- ◆ Selection of Flux
 1. Since flux may have a significant effect on the performance of capacitors, it is necessary to verify the following conditions prior to use;
 - (1) Flux used should be with less than or equal to 0.1 wt% (equivalent to chlorine) of halogenated content. Flux having strong acidity content should not be applied.
 - (2) When soldering capacitors on the board, the amount of flux applied should be controlled at the optimum level.
 - (3) When using water-soluble flux, special care should be taken to properly clean the boards.
- ◆ Soldering
 1. Temperature, time, amount of solder, etc. are specified in accordance with the following recommended conditions.
 - Sn-Zn solder paste can affect MLCC reliability performance.
 - Please contact us prior to usage.

Technical considerations

- ◆ Selection of Flux
 - 1-1. When too much halogenated substance (Chlorine, etc.) content is used to activate the flux, or highly acidic flux is used, an excessive amount of residue after soldering may lead to corrosion of the terminal electrodes or degradation of insulation resistance on the surface of the capacitors.
 - 1-2. Flux is used to increase solderability in flow soldering, but if too much is applied, a large amount of flux gas may be emitted and may detrimentally affect solderability. To minimize the amount of flux applied, it is recommended to use a flux-bubbling system.
 - 1-3. Since the residue of water-soluble flux is easily dissolved by water content in the air, the residue on the surface of capacitors in high humidity conditions may cause a degradation of insulation resistance and therefore affect the reliability of the components. The cleaning methods and the capability of the machines used should also be considered carefully when selecting water-soluble flux.
- ◆ Soldering
 - 1-1. Preheating when soldering
 - Heating: Ceramic chip components should be preheated to within 100 to 130°C of the soldering.
 - Cooling: The temperature difference between the components and cleaning process should not be greater than 100°C.
 - Ceramic chip capacitors are susceptible to thermal shock when exposed to rapid or concentrated heating or rapid cooling. Therefore, the soldering process must be conducted with great care so as to prevent malfunction of the components due to excessive thermal shock.

【Recommended conditions for soldering】

[Reflow soldering]
Temperature profile

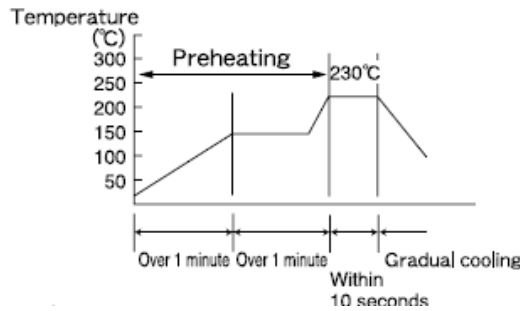

【Recommended conditions for Pd Free soldering】

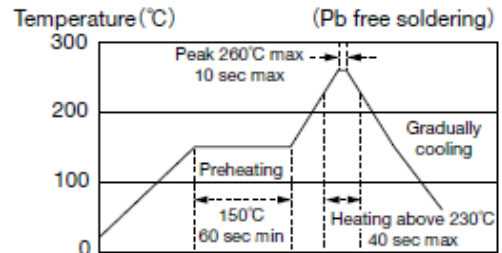

- ※ Ceramic chip components should be preheated to within 100 to 130°C of the soldering.
- ※ Assured to be reflow soldering for 2 times.

Caution

① The ideal condition is to have solder mass (fillet) controlled to 1/2 to 1/3 of the thickness of the capacitor, as shown below:

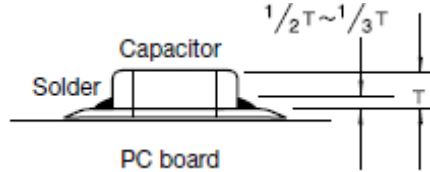

② Because excessive dwell times can detrimentally affect solderability, soldering duration should be kept as close to recommended times as possible.