



TRM-xxx-DP1203
Data Guide

Wireless made simple[®]

Table of Contents

1	Description
1	Features
1	Applications
2	Ordering Information
2	Absolute Maximum Ratings
2	Electrical Specifications
4	Pin Assignments
5	Pin Descriptions
6	Functional Description
6	Operating Modes
7	Serial Control Interface
9	Typical Applications
9	XE1203F Configuration Registers
10	Power Supply Requirements
10	Antenna Considerations
11	Interference Considerations
12	Pad Layout
12	Board Layout Guidelines
14	Microstrip Details
15	Helpful Application Notes from Linx
16	Production Guidelines
16	Hand Assembly
16	Automated Assembly
18	General Antenna Rules
20	Common Antenna Styles
22	Regulatory Considerations



Warning: Linx radio frequency ("RF") products may be used to control machinery or devices remotely, including machinery or devices that can cause death, bodily injuries, and/or property damage if improperly or inadvertently triggered, particularly in industrial settings or other applications implicating life-safety concerns. No Linx Technologies product is intended for use in any application without redundancies where the safety of life or property is at risk.

The customers and users of devices and machinery controlled with RF products must understand and must use all appropriate safety procedures in connection with the devices, including without limitation, using appropriate safety procedures to prevent inadvertent triggering by the user of the device and using appropriate security codes to prevent triggering of the remote controlled machine or device by users of other remote controllers.

Do not use this or any Linx product to trigger an action directly from the data line or RSSI lines without a protocol or encoder/decoder to validate the data. Without validation, any signal from another unrelated transmitter in the environment received by the module could inadvertently trigger the action. This module does not have data validation built in.

All RF products are susceptible to RF interference that can prevent communication. RF products without frequency agility or hopping implemented are more subject to interference. This module does not have frequency agility built in, but the developer can implement frequency agility with a microcontroller.

Do not use any Linx product over the limits in this data guide. Excessive voltage or extended operation at the maximum voltage could cause product failure. Exceeding the reflow temperature profile could cause product failure which is not immediately evident.

Do not make any physical or electrical modifications to any Linx product. This will void the warranty and regulatory and UL certifications and may cause product failure which is not immediately evident.

Description

The TRM-xxx-DP1203 is a complete Radio Transceiver Module operating in the 433, 868 and 915MHz license free ISM (Industrial Scientific and medical) frequency bands.

The TRM-xxx-DP1203 offers the unique advantage of high data rate communication up to 152.3kbps. The radio module is suitable

for applications seeking to satisfy the European (ETSI EN300-220-1 and EN301 439-3) or the North American (FCC part 15.247 and 15.249) regulatory standards.

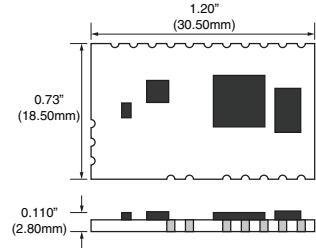

Figure 1: Package Dimensions

The TRM-xxx-DP1203 modules can be used in any environment where wireless remote connection is an advantage. They are perfect for complex wireless networks involving high speed data rate applications.

Features

- True UART to antenna solution
- 433/868/925MHz
- No RF knowledge required
- 30.5mm x 18.5mm
- Direct Digital Interface
- Fully assembled and tested
- Surface mount
- Supply voltage 2.4V–3.6V
- Frequency synthesizer step size of 500Hz
- Data rate up to 153.2kbps
- Output power is programmable up to 15dBm
- High Rx 0.1% sensitivity down to –113dBm at 4.8kbps
- Current consumption
TX = 62mA at 15dBm,
RX = 14mA
- Digital RSSI (Received Signal Strength Indicator)
- Digital FEI (Frequency Error Indicator)

Applications

- Home automation
- Process, access and building controls
- Home appliance interconnections

Ordering Information

Ordering Information		
Part No.	Description	Radiotronix Part No.
TRM-433-DP1203	433MHz DP1203 RF Transceiver Module	Wi.DP1203-433-R
TRM-868-DP1203	868MHz DP1203 RF Transceiver Module	Wi.DP1203-868-R
TRM-915-DP1203	915MHz DP1203 RF Transceiver Module	Wi.DP1203-915-R

Figure 2: Ordering Information

Absolute Maximum Ratings

Absolute Maximum Ratings			
Description	Min.	Max.	Unit
Vdd – Power Supply	2.4	3.6	VDC
Operating Temperature	-40	+85	°C
Storage Temperature	-55	+125	°C
Soldering Temperature (max 15 seconds)		+260	°C

Figure 3: Absolute Maximum Ratings



Warning: This product incorporates numerous static-sensitive components. Always wear an ESD wrist strap and observe proper ESD handling procedures when working with this device. Failure to observe this precaution may result in module damage or failure.

Electrical Specifications

Figure 4 gives the specifications of the TRM-xxx-DP1203 modules under the following conditions:

Supply voltage VDD = 3.3V, temperature = 25°C, frequency deviation Δf = 5kHz, Bit-rate = 4.8kbps, base-band filter bandwidth BWSSB = 10kHz, carrier frequency f_c = 434MHz for the TRM-433-DP1203, f_c = 869MHz for the TRM-868-DP1203 and f_c = 915MHz for the TRM-915-DP1203, bit error rate BER = 0.1% (measured at the output of the bit synchronizer), antenna output matched at 50Ω.

DP1203 Series Transceiver Specifications

Parameter	Symbol	Min.	Typ.	Max.	Units	Notes
Power Supply						
Operating Voltage	V_{CC}	2.4		3.6	VDC	
TX Supply Current	I_{OCTX}					
At +11dBm			62	75	mA	
At 5dBm			33	40	mA	
RX Supply Current	I_{OCTX}		14	17	mA	
Sleep Current	I_{SLP}		0.2	1	μ A	
Standby Current	I_{STD}		0.85	1.1	mA	
RF Section						
Center Frequency Range	F_C					
TRM-433-DP1203		433		436	MHz	
TRM-868-DP1203		868		870	MHz	
TRM-915-DP1203		902		928	MHz	
Data Rate		1.2		152.3	kbps	
Receiver Section						
A-mode			-111	-108	dBm	
Transmitter Section						
Output Power	P_O					
RFOP1		-3	0		dBm	1
RFOP2		+2	+5		dBm	1
RFOP3		+7	+10		dBm	1
RFOP3		+12	+15		dBm	1
Frequency Deviation	F_{DEV}	1		255	kHz	1
Timing						
Transmit Wake-up Time			150	250	μ s	2
Receive Wake-up Time			0.5	0.8	ms	2
Quartz Oscillator Wake-up Time			1	2	ms	
Quartz Oscillator Frequency		39			MHz	
Interface Section						
Input						
Logic Low		75			%VDD	
Logic High				25	%VDD	

1. Programmable
2. From Oscillator Enabled

Figure 4: Detailed Electrical Specifications

Pin Assignments

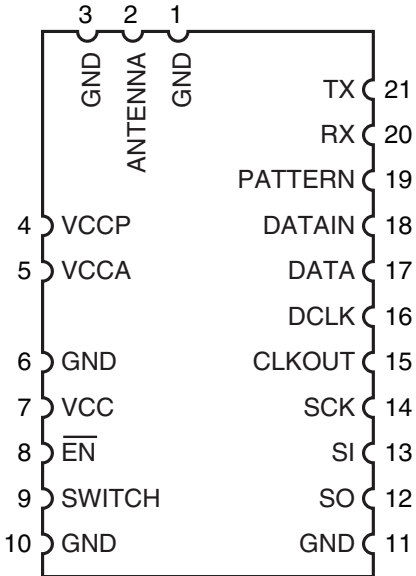

Figure 5: DP1203 Series Transceiver Pin Assignments (Top View)

Pin Descriptions

Pin Descriptions			
Pin	Name	I/O	Description
1	GND		Ground
2	ANTENNA	I/O	50-ohm RF Antenna Port
3	GND	—	Ground
4	VCCP	—	Supply Voltage / advised NC
5	VCCA	—	Supply Voltage
6	GND	—	Ground
7	VCC	—	Supply Voltage
8	$\overline{\text{EN}}$	I	3-wire Interface Communication Enable Signal.
9	SWITCH	I/O	Selects between two pre-configured states, e.g. transmit and receive. The states are determined by the SWParam register.
10	GND	I	Ground
11	GND	I	Ground
12	SO	O	Data output of the 3-wire interface
13	SI	I	Data input of the 3-wire interface
14	SCK	I	Data clock of the 3-wire interface
15	CLKOUT	O	Programmable Clock Output: F_{XTAL} divided by 4, 8, 16 or 32
16	DCLK	O	Receiver Data Clock
17	DATA	I/O	Transmitter Data Input and Receiver Data Output. This is a bi-directional line that changes based on the module's TX/RX state. This line can be set to the receiver data output only by disabling the bidirectional data in the ADParam register.
18	DATAIN	I	Transmitter Data Input. This line is the transmitter data input when bidirectional data is disabled using the ADParam register. This line is not used when bidirectional data is enabled.
19	PATTERN	O	Output of the Pattern Recognition Block. This line goes high when the module detects a received bit pattern that matches a pattern stored in the Pattern configuration register.
20	RX	I	Antenna Switch RX Select. Set high for receive mode; must be set opposite the TX line
21	TX	I	Antenna Switch TX Select. Set high for transmit mode; must be set opposite the RX line.

Figure 6: DP1203 Series Transceiver Pin Descriptions

Functional Description

The TRM-xxx-DP1203 is a cost-effective, radio transceiver module designed for the wireless transmission of digital information over distances of 2 to 3 miles (3.2 to 4.8km). Regulations in the country of operation dictate the maximum output power, so the final system range depends on local regulations and frequency. The module is based on the XE1203F RF transceiver from Semtech. This guide describes some of the features of the module, but does not go into detail on the transceiver chip. For more information, refer to the XE1203F datasheet available from the Semtech website at www.semtech.com.

The module incorporates an antenna switch driven by two external lines (TX and RX) and a SAW Filter placed on the receive path. Figure 7 shows a basic block diagram of the module.

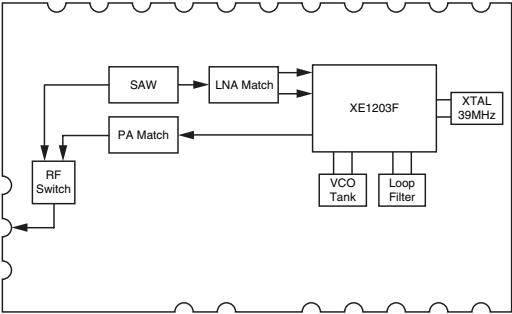

Figure 7: DP1203 Series Transceiver Block Diagram

Operating Modes

When operating the DP1203, it might be useful to quickly switch between two pre-defined operating modes, to save time and traffic on the 3-wire serial interface bus. This may occur when the DP1203 is required to switch quickly between receive and transmit modes, when it has to operate on two different carrier frequencies, or when it has to switch between the high linearity mode B and the high sensitivity mode A.

The XE1203F has five parameters that determine the operating conditions of the transceiver. Each parameter is duplicated and saved in two sets in the SWParam configuration register; Set #1 and Set #2. These parameter sets can be pre-configured.

The module can quickly switch between the two sets in one of two ways based on the RTPParam_Switch_ext bit. If this bit is low then the set is selected through the 3-wire bus using the ConfigSwitch 1-bit register. If this bit is low, then Set #1 is selected. If it is high, then Set #2 is selected.

If the RTParam_Switch_ext bit is high, then the set is selected by the SWITCH line. If this line is low, then Set #1 is selected. If it is high, then Set #2 is selected.

These two sets can be used to select between transmit and receive mode, but the TX and RX lines also need to be set appropriately. Figure 8 summarizes the XE1203F programming.

Serial Control Interface

ConfigSwitch, SWITCH Line and SWParam Configuration Register			
RTParam_switch_ext configuration parameter	Switch Line	ConfigSwitch Register	SWParam configuration set selected
0	Switch is an output: '1' in TX mode '0' in other modes	0	Set #1 SWParam_mode_1 SWParam_Power_1 SWParam_Rmode_1 SWParam_t_delsig_in_1 SWParam_freq_1
0	Switch is an output: '1' in TX mode '0' in other modes	1	Set #2 SWParam_mode_2 SWParam_Power_2 SWParam_Rmode_2 SWParam_t_delsig_in_2 SWParam_freq_2
1	0	X	Set #1 SWParam_mode_1 SWParam_Power_1 SWParam_Rmode_1 SWParam_t_delsig_in_1 SWParam_freq_1
1	1	X	Set #2 SWParam_mode_2 SWParam_Power_2 SWParam_Rmode_2 SWParam_t_delsig_in_2 SWParam_freq_2

Figure 8: ConfigSwitch, SWITCH Line and SWParam Configuration Register

A 3-wire bi-directional bus (SCK, SI, SO) is used to control the module. The output signal, SO, is provided by the module and SCK and SI need to be provided by an external microcontroller. An access Read or Write with the XE1203 is possible only when the enable signal is active (active LOW).

For more information about the 3-wire bus refer to the XE1203 data sheet chapter; *Serial Interface Definition and Principles of Operation*. Figure 9 shows a typical write sequence into a configuration register.

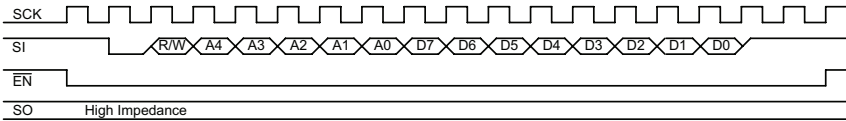

Figure 9: Write Sequence Into a Configuration Register

Figure 10 shows a typical read sequence from a configuration register.

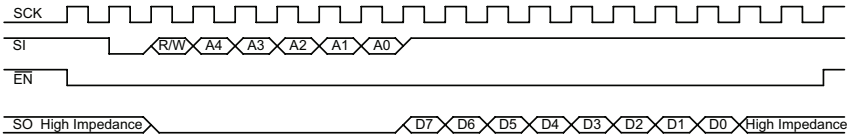

Figure 10: Read Sequence from a Configuration Register

Switching between Modes

The TRM-xxx-DP1203 is able to switch between two configurations by using the 3-wire bus or by using the SWITCH line. Figure 11 shows the switching sequence using the 3-wire bus to switch from Set #1 to Set #2. In these examples, Set #1 is programmed to configure the module as a transmitter and Set #2 is programmed to set the module as a receiver.

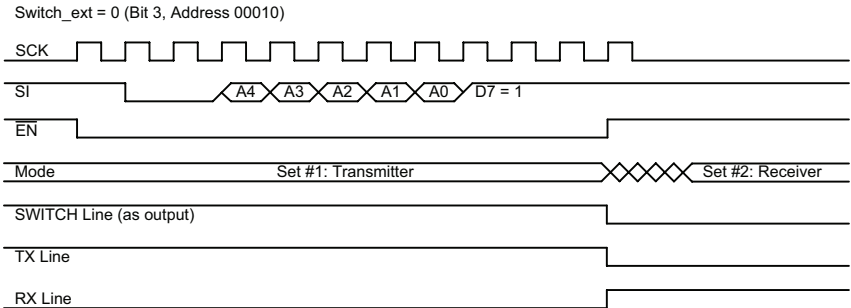

Figure 11: Switching Sequence Using the 3-wire Bus

Figure 12 shows the switching sequence using the SWITCH line go change from Set #1 to Set #2.

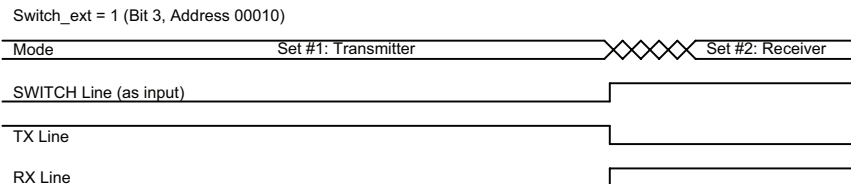

Figure 12: Switching Sequence Using the SWITCH Line

Typical Applications

The schematic in Figure 11 shows the TRM-xxx-DP1203 interfaced with a microcontroller.

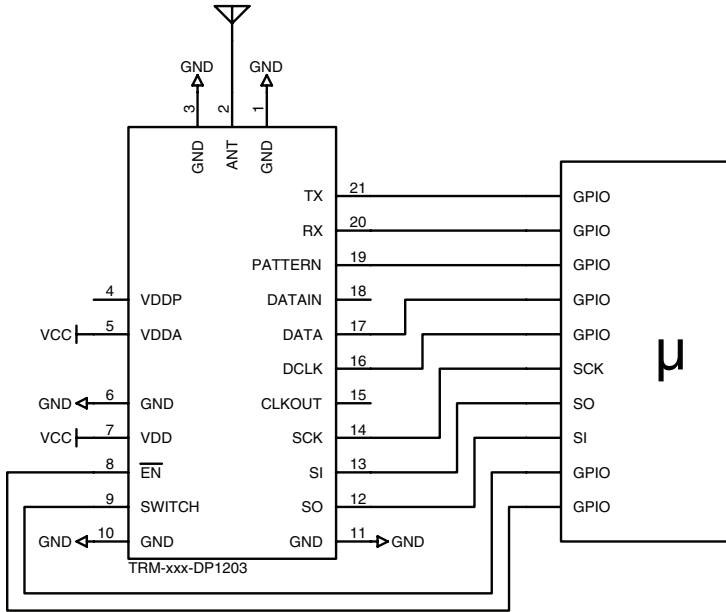

Figure 13: TRM-xxx-DP1203 Typical Application Schematic

XE1203F Configuration Registers

Figure 14 shows the configuration registers in the XE1203F transceiver. For more information on the registers please see the XE1203 Data Sheet.

XE1203 Configuration Registers			
Name	Description	Size (bits)	Address (Binary Format)
ConfigSwitch	1-bit data to switch between 2 sets of user-predefined SWParam Configuration Registers	1 x 1	00000
RTPParam	Receiver and transmitter parameters	2 x 8	00001 - 00010
FSPParam	LO, Bitrate, Deviation and other frequency parameters	3 x 8	00011 - 00101
SWParam	2 sets of user-predefined configuration registers	6 x 8	00110 - 01011
DataOut	Status register which can be read through the 3-wire serial interface	2 x 8	01100 - 01101
ADParam	Additional parameters	5 x 8	01110 - 10010
Pattern	Reference pattern for the "pattern recognition" feature	4 x 8	10011 - 10110

Figure 14: XE1203F Configuration Registers

Power Supply Requirements

The module does not have an internal regulator; therefore it requires a clean, well-regulated power source. Power supply noise can significantly affect the module's performance, so providing a clean power supply for the module should be a high priority during design.

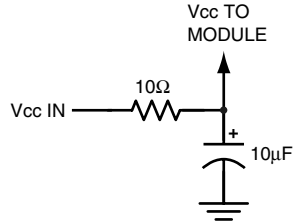

Figure 15: Supply Filter

A 10Ω resistor in series with the supply followed by a 10μF tantalum capacitor from V_{cc} to ground helps in cases where the quality of supply power is poor (Figure 15). This filter should be placed close to the module's supply lines. These values may need to be adjusted depending on the noise present on the supply line.

Antenna Considerations

The choice of antennas is a critical and often overlooked design consideration. The range, performance and legality of an RF link are critically dependent upon the antenna. While adequate antenna performance can often be obtained by trial and error methods, antenna design and matching is a complex task. Professionally designed antennas such as those from Linx (Figure 16) help ensure maximum performance and FCC and other regulatory compliance.



Figure 16: Linx Antennas

Linx transmitter modules typically have an output power that is higher than the legal limits. This allows the designer to use an inefficient antenna such as a loop trace or helical to meet size, cost or cosmetic requirements and still achieve full legal output power for maximum range. If an efficient antenna is used, then some attenuation of the output power will likely be needed. This can easily be accomplished by using the SWParam_Power_1 and SWParam_Power_2 parameters.

It is usually best to utilize a basic quarter-wave whip until your prototype product is operating satisfactorily. Other antennas can then be evaluated based on the cost, size and cosmetic requirements of the product. Additional details are in Application Note AN-00500.

Interference Considerations

The RF spectrum is crowded and the potential for conflict with unwanted sources of RF is very real. While all RF products are at risk from interference, its effects can be minimized by better understanding its characteristics.

Interference may come from internal or external sources. The first step is to eliminate interference from noise sources on the board. This means paying careful attention to layout, grounding, filtering and bypassing in order to eliminate all radiated and conducted interference paths. For many products, this is straightforward; however, products containing components such as switching power supplies, motors, crystals and other potential sources of noise must be approached with care. Comparing your own design with a Linx evaluation board can help to determine if and at what level design-specific interference is present.

External interference can manifest itself in a variety of ways. Low-level interference produces noise and hashing on the output and reduces the link's overall range.

High-level interference is caused by nearby products sharing the same frequency or from near-band high-power devices. It can even come from your own products if more than one transmitter is active in the same area. It is important to remember that only one transmitter at a time can occupy a frequency, regardless of the coding of the transmitted signal. This type of interference is less common than those mentioned previously, but in severe cases it can prevent all useful function of the affected device.

Although technically not interference, multipath is also a factor to be understood. Multipath is a term used to refer to the signal cancellation effects that occur when RF waves arrive at the receiver in different phase relationships. This effect is a particularly significant factor in interior environments where objects provide many different signal reflection paths. Multipath cancellation results in lowered signal levels at the receiver and shorter useful distances for the link.

Pad Layout

The pad layout diagram in Figure 17 is designed to facilitate both hand and automated assembly.

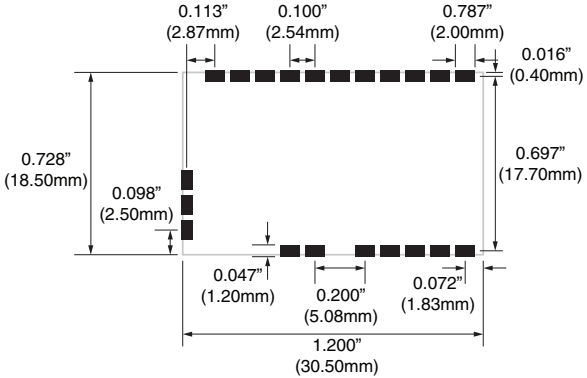

Figure 17: Recommended PCB Layout

Board Layout Guidelines

The module’s design makes integration straightforward; however, it is still critical to exercise care in PCB layout. Failure to observe good layout techniques can result in a significant degradation of the module’s performance. A primary layout goal is to maintain a characteristic 50-ohm impedance throughout the path from the antenna to the module. Grounding, filtering, decoupling, routing and PCB stack-up are also important considerations for any RF design. The following section provides some basic design guidelines.

During prototyping, the module should be soldered to a properly laid-out circuit board. The use of prototyping or “perf” boards results in poor performance and is strongly discouraged. Likewise, the use of sockets can have a negative impact on the performance of the module and is discouraged.

The module should, as much as reasonably possible, be isolated from other components on your PCB, especially high-frequency circuitry such as crystal oscillators, switching power supplies, and high-speed bus lines.

When possible, separate RF and digital circuits into different PCB regions.

Make sure internal wiring is routed away from the module and antenna and is secured to prevent displacement.

Do not route PCB traces directly under the module. There should not be any copper or traces under the module on the same layer as the module, just bare PCB. The underside of the module has traces and vias that could short or couple to traces on the product's circuit board.

The Pad Layout section shows a typical PCB footprint for the module. A ground plane (as large and uninterrupted as possible) should be placed on a lower layer of your PC board opposite the module. This plane is essential for creating a low impedance return for ground and consistent stripline performance.

Use care in routing the RF trace between the module and the antenna or connector. Keep the trace as short as possible. Do not pass it under the module or any other component. Do not route the antenna trace on multiple PCB layers as vias add inductance. Vias are acceptable for tying together ground layers and component grounds and should be used in multiples.

Each of the module's ground pins should have short traces tying immediately to the ground plane through a via.

Bypass caps should be low ESR ceramic types and located directly adjacent to the pin they are serving.

A 50-ohm coax should be used for connection to an external antenna. A 50-ohm transmission line, such as a microstrip, stripline or coplanar waveguide should be used for routing RF on the PCB. The Microstrip Details section provides additional information.

In some instances, a designer may wish to encapsulate or "pot" the product. There are a wide variety of potting compounds with varying dielectric properties. Since such compounds can considerably impact RF performance and the ability to rework or service the product, it is the responsibility of the designer to evaluate and qualify the impact and suitability of such materials.

Microstrip Details

A transmission line is a medium whereby RF energy is transferred from one place to another with minimal loss. This is a critical factor, especially in high-frequency products like Linx RF modules, because the trace leading to the module's antenna can effectively contribute to the length of the antenna, changing its resonant bandwidth. In order to minimize loss and detuning, some form of transmission line between the antenna and the module should be used unless the antenna can be placed very close (<1/8in) to the module. One common form of transmission line is a coax cable and another is the microstrip. This term refers to a PCB trace running over a ground plane that is designed to serve as a transmission line between the module and the antenna. The width is based on the desired characteristic impedance of the line, the thickness of the PCB and the dielectric constant of the board material. For standard 0.062in thick FR-4 board material, the trace width would be 111 mils. The correct trace width can be calculated for other widths and materials using the information in Figure 18 and examples are provided in Figure 19. Software for calculating microstrip lines is also available on the Linx website.

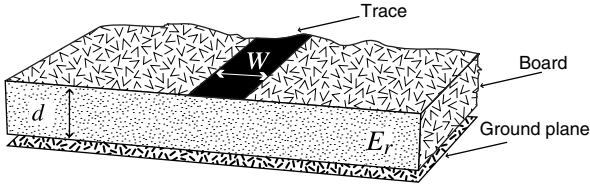

$$E_e = \frac{E_r + 1}{2} + \frac{E_r - 1}{2} \cdot \frac{1}{\sqrt{1 + 12d/W}}$$

$$Z_0 = \begin{cases} \frac{60}{\sqrt{E_e}} \cdot \ln\left(\frac{8d}{W} + \frac{W}{4d}\right) & \text{For } \frac{W}{d} \leq 1 \\ \frac{120\pi}{\sqrt{E_e} \cdot \left(\frac{W}{d} + 1.393 + 0.667 \cdot \ln\left(\frac{W}{d} + 1.444\right)\right)} & \text{For } \frac{W}{d} \geq 1 \end{cases}$$

Er = Dielectric constant of PCB material

Figure 18: Microstrip Formulas

Example Microstrip Calculations			
Dielectric Constant	Width / Height Ratio (W / d)	Effective Dielectric Constant	Characteristic Impedance (Ω)
4.80	1.8	3.59	50.0
4.00	2.0	3.07	51.0
2.55	3.0	2.12	48.8

Figure 19: Example Microstrip Calculations

Helpful Application Notes from Linx

It is not the intention of this manual to address in depth many of the issues that should be considered to ensure that the modules function correctly and deliver the maximum possible performance. We recommend reading the application notes listed in Figure 20 which address in depth key areas of RF design and application of Linx products. These applications notes are available online at www.linxtechnologies.com or by contacting Linx.

Helpful Application Note Titles	
Note Number	Note Title
AN-00100	RF 101: Information for the RF Challenged
AN-00126	Considerations for Operation Within the 902–928MHz Band
AN-00130	Modulation Techniques for Low-Cost RF Data Links
AN-00140	The FCC Road: Part 15 from Concept to Approval
AN-00500	Antennas: Design, Application, Performance
AN-00501	Understanding Antenna Specifications and Operation
RG-00103	TT Series Transceiver Command Data Interface Reference Guide

Figure 20: Helpful Application Note Titles

Production Guidelines

The module is housed in a hybrid SMD package that supports hand and automated assembly techniques. Since the modules contain discrete components internally, the assembly procedures are critical to ensuring the reliable function of the modules. The following procedures should be reviewed with and practiced by all assembly personnel.

Hand Assembly

Pads located on the bottom of the module are the primary mounting surface (Figure 21). Since these pads are inaccessible during mounting, castellations that run up the side of the module have been provided to facilitate solder wicking to the module's underside. This allows for very

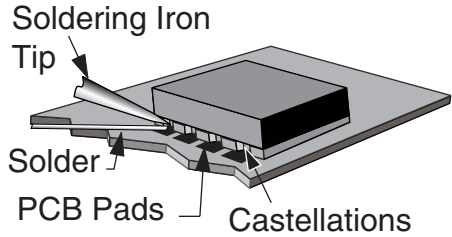

Figure 21: Soldering Technique

quick hand soldering for prototyping and small volume production. If the recommended pad guidelines have been followed, the pads will protrude slightly past the edge of the module. Use a fine soldering tip to heat the board pad and the castellation, then introduce solder to the pad at the module's edge. The solder will wick underneath the module, providing reliable attachment. Tack one module corner first and then work around the device, taking care not to exceed the times in Figure 22.

Warning: Pay attention to the absolute maximum solder times.

Absolute Maximum Solder Times

Hand Solder Temperature: +225°C for 10 seconds

Reflow Oven: +225°C max (see Figure 34)

Figure 22: Absolute Maximum Solder Times

Automated Assembly

For high-volume assembly, the modules are generally auto-placed. The modules have been designed to maintain compatibility with reflow processing techniques; however, due to their hybrid nature, certain aspects of the assembly process are far more critical than for other component types. Following are brief discussions of the three primary areas where caution must be observed.

Reflow Temperature Profile

The single most critical stage in the automated assembly process is the reflow stage. The reflow profile in Figure 23 should not be exceeded because excessive temperatures or transport times during reflow will irreparably damage the modules. Assembly personnel need to pay careful attention to the oven's profile to ensure that it meets the requirements necessary to successfully reflow all components while still remaining within the limits mandated by the modules. The figure below shows the recommended reflow oven profile for the modules.

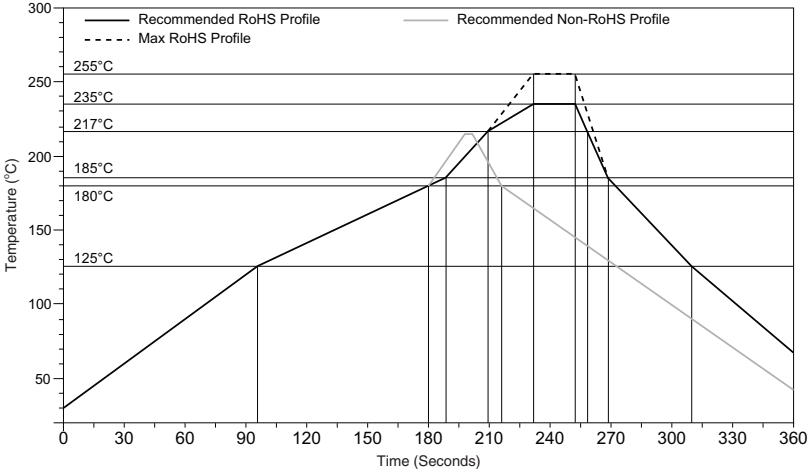

Figure 23: Maximum Reflow Temperature Profile

Shock During Reflow Transport

Since some internal module components may reflow along with the components placed on the board being assembled, it is imperative that the modules not be subjected to shock or vibration during the time solder is liquid. Should a shock be applied, some internal components could be lifted from their pads, causing the module to not function properly.

Washability

The modules are wash-resistant, but are not hermetically sealed. Linx recommends wash-free manufacturing; however, the modules can be subjected to a wash cycle provided that a drying time is allowed prior to applying electrical power to the modules. The drying time should be sufficient to allow any moisture that may have migrated into the module to evaporate, thus eliminating the potential for shorting damage during power-up or testing. If the wash contains contaminants, the performance may be adversely affected, even after drying.

General Antenna Rules

The following general rules should help in maximizing antenna performance.

1. Proximity to objects such as a user's hand, body or metal objects will cause an antenna to detune. For this reason, the antenna shaft and tip should be positioned as far away from such objects as possible.
2. Optimum performance is obtained from a 1/4- or 1/2-wave straight whip mounted at a right angle to the ground plane (Figure 24). In many cases, this isn't desirable for practical or ergonomic reasons, thus, an alternative antenna style such as a helical, loop or patch may be utilized and the corresponding sacrifice in performance accepted.

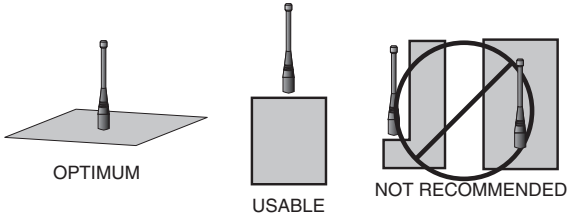

Figure 24: Ground Plane Orientation

3. If an internal antenna is to be used, keep it away from other metal components, particularly large items like transformers, batteries, PCB tracks and ground planes. In many cases, the space around the antenna is as important as the antenna itself. Objects in close proximity to the antenna can cause direct detuning, while those farther away will alter the antenna's symmetry.

4. In many antenna designs, particularly 1/4-wave whips, the ground plane acts as a counterpoise, forming, in essence, a 1/2-wave dipole (Figure 25). For this reason, adequate ground plane area is essential. The ground plane can be a metal case or ground-fill areas on a circuit board. Ideally, it should have a surface area less than or equal to the overall length of the 1/4-wave radiating element. This is often not practical due to size and configuration constraints. In these instances, a designer must make the best use of the area available to create as much ground

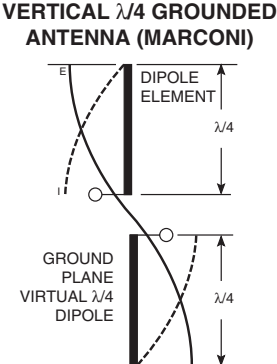

Figure 25: Dipole Antenna

plane as possible in proximity to the base of the antenna. In cases where the antenna is remotely located or the antenna is not in close proximity to a circuit board, ground plane or grounded metal case, a metal plate may be used to maximize the antenna's performance.

5. Remove the antenna as far as possible from potential interference sources. Any frequency of sufficient amplitude to enter the receiver's front end will reduce system range and can even prevent reception entirely. Switching power supplies, oscillators or even relays can also be significant sources of potential interference. The single best weapon against such problems is attention to placement and layout. Filter the module's power supply with a high-frequency bypass capacitor. Place adequate ground plane under potential sources of noise to shunt noise to ground and prevent it from coupling to the RF stage. Shield noisy board areas whenever practical.
6. In some applications, it is advantageous to place the module and antenna away from the main equipment (Figure 26). This can avoid interference problems and allows the antenna to be oriented for optimum performance. Always use 50Ω coax, like RG-174, for the remote feed.

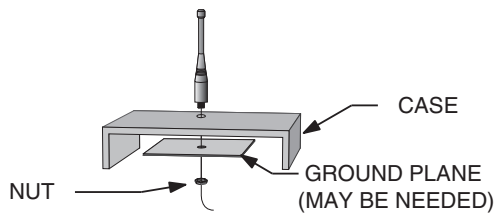

Figure 26: Remote Ground Plane

Common Antenna Styles

There are hundreds of antenna styles and variations that can be employed with Linx RF modules. Following is a brief discussion of the styles most commonly utilized. Additional antenna information can be found in Linx Application Notes AN-00100, AN-00140, AN-00500 and AN-00501. Linx antennas and connectors offer outstanding performance at a low price.

Whip Style

A whip style antenna (Figure 27) provides outstanding overall performance and stability. A low-cost whip can be easily fabricated from a wire or rod, but most designers opt for the consistent performance and cosmetic appeal of a professionally-made model. To meet this need, Linx offers a wide variety of straight and reduced height whip style antennas in permanent and connectorized mounting styles.



Figure 27: Whip Style Antennas

The wavelength of the operational frequency determines an antenna's overall length. Since a full wavelength is often quite long, a partial 1/2- or 1/4-wave antenna is normally employed. Its size and natural radiation resistance make it well matched to Linx modules. The proper length for a straight 1/4-wave can be easily determined using the formula in Figure 28. It is also possible to reduce the overall height of the antenna by using a helical winding. This reduces the antenna's bandwidth but is a great way to minimize the antenna's physical size for compact applications. This also means that the physical appearance is not always an indicator of the antenna's frequency.

$$L = \frac{234}{F_{\text{MHz}}}$$

Figure 28:
L = length in feet of quarter-wave length
F = operating frequency in megahertz

Specialty Styles

Linx offers a wide variety of specialized antenna styles (Figure 29). Many of these styles utilize helical elements to reduce the overall antenna size while maintaining reasonable performance. A helical antenna's bandwidth is often quite narrow and the antenna can detune in proximity to other objects, so care must be exercised in layout and placement.



Figure 29: Specialty Style Antennas

Loop Style

A loop or trace style antenna is normally printed directly on a product's PCB (Figure 30). This makes it the most cost-effective of antenna styles. The element can be made self-resonant or externally resonated with discrete components, but its actual layout is usually product specific. Despite the cost advantages, loop style antennas are generally

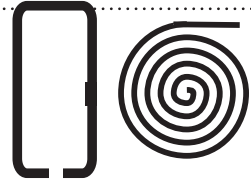

Figure 30: Loop or Trace Antenna

inefficient and useful only for short range applications. They are also very sensitive to changes in layout and PCB dielectric, which can cause consistency issues during production. In addition, printed styles are difficult to engineer, requiring the use of expensive equipment including a network analyzer. An improperly designed loop will have a high VSWR at the desired frequency which can cause instability in the RF stage.

Linx offers low-cost planar (Figure 31) and chip antennas that mount directly to a product's PCB. These tiny antennas do not require testing and provide excellent performance despite their small size. They offer a preferable alternative to the often problematic "printed" antenna.

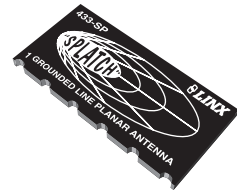

Figure 31: SP Series "Splatch" Antenna

Regulatory Considerations

Note: Linx RF modules are designed as component devices that require external components to function. The purchaser understands that additional approvals may be required prior to the sale or operation of the device, and agrees to utilize the component in keeping with all laws governing its use in the country of operation.

When working with RF, a clear distinction must be made between what is technically possible and what is legally acceptable in the country where operation is intended. Many manufacturers have avoided incorporating RF into their products as a result of uncertainty and even fear of the approval and certification process. Here at Linx, our desire is not only to expedite the design process, but also to assist you in achieving a clear idea of what is involved in obtaining the necessary approvals to legally market a completed product.

For information about regulatory approval, read AN-00142 on the Linx website or call Linx. Linx designs products with worldwide regulatory approval in mind.

In the United States, the approval process is actually quite straightforward. The regulations governing RF devices and the enforcement of them are the responsibility of the Federal Communications Commission (FCC). The regulations are contained in Title 47 of the United States Code of Federal Regulations (CFR). Title 47 is made up of numerous volumes; however, all regulations applicable to this module are contained in Volume 0-19. It is strongly recommended that a copy be obtained from the FCC's website, the Government Printing Office in Washington or from your local government bookstore. Excerpts of applicable sections are included with Linx evaluation kits or may be obtained from the Linx Technologies website, www.linxtechnologies.com. In brief, these rules require that any device that intentionally radiates RF energy be approved, that is, tested for compliance and issued a unique identification number. This is a relatively painless process. Final compliance testing is performed by one of the many independent testing laboratories across the country. Many labs can also provide other certifications that the product may require at the same time, such as UL, CLASS A / B, etc. Once the completed product has passed, an ID number is issued that is to be clearly placed on each product manufactured.

Questions regarding interpretations of the Part 2 and Part 15 rules or the measurement procedures used to test intentional radiators such as Linx RF modules for compliance with the technical standards of Part 15 should be addressed to:

Federal Communications Commission
Equipment Authorization Division
Customer Service Branch, MS 1300F2
7435 Oakland Mills Road
Columbia, MD, US 21046
Phone: + 1 301 725 585 | Fax: + 1 301 344 2050
Email: labinfo@fcc.gov

ETSI Secretaria
650, Route des Lucioles
06921 Sophia-Antipolis Cedex
FRANCE
Phone: +33 (0)4 92 94 42 00
Fax: +33 (0)4 93 65 47 16

International approvals are slightly more complex, although Linx modules are designed to allow all international standards to be met. If the end product is to be exported to other countries, contact Linx to determine the specific suitability of the module to the application.

All Linx modules are designed with the approval process in mind and thus much of the frustration that is typically experienced with a discrete design is eliminated. Approval is still dependent on many factors, such as the choice of antennas, correct use of the frequency selected and physical packaging. While some extra cost and design effort are required to address these issues, the additional usefulness and profitability added to a product by RF makes the effort more than worthwhile.



LinX Technologies
159 Ort Lane
Merlin, OR, US 97532

3090 Sterling Circle, Suite 200
Boulder, CO 80301

Phone: +1 541 471 6256
Fax: +1 541 471 6251
www.linxtechnologies.com

Disclaimer

LinX Technologies is continually striving to improve the quality and function of its products. For this reason, we reserve the right to make changes to our products without notice. The information contained in this Data Guide is believed to be accurate as of the time of publication. Specifications are based on representative lot samples. Values may vary from lot-to-lot and are not guaranteed. "Typical" parameters can and do vary over lots and application. LinX Technologies makes no guarantee, warranty, or representation regarding the suitability of any product for use in any specific application. It is Customer's responsibility to verify the suitability of the part for the intended application. At Customer's request, LinX Technologies may provide advice and assistance in designing systems and remote control devices that employ LinX Technologies RF products, but responsibility for the ultimate design and use of any such systems and devices remains entirely with Customer and/or user of the RF products.

LINX TECHNOLOGIES DISCLAIMS ANY AND ALL WARRANTIES OF MERCHANTABILITY AND FITNESS FOR A PARTICULAR PURPOSE. IN NO EVENT SHALL LINX TECHNOLOGIES BE LIABLE FOR ANY CUSTOMER'S OR USER'S INCIDENTAL OR CONSEQUENTIAL DAMAGES ARISING OUT OF OR RELATED TO THE DESIGN OR USE OF A REMOTE CONTROL SYSTEM OR DEVICE EMPLOYING LINX TECHNOLOGIES RF PRODUCTS OR FOR ANY OTHER BREACH OF CONTRACT BY LINX TECHNOLOGIES. CUSTOMER AND/OR USER ASSUME ALL RISKS OF DEATH, BODILY INJURIES, OR PROPERTY DAMAGE ARISING OUT OF OR RELATED TO THE USE OF LINX TECHNOLOGIES RF PRODUCTS, INCLUDING WITH RESPECT TO ANY SERVICES PROVIDED BY LINX RELATED TO THE USE OF LINX TECHNOLOGIES RF PRODUCTS. LINX TECHNOLOGIES SHALL NOT BE LIABLE UNDER ANY CIRCUMSTANCES FOR A CUSTOMER'S, USER'S, OR OTHER PERSON'S DEATH, BODILY INJURY, OR PROPERTY DAMAGE ARISING OUT OF OR RELATED TO THE DESIGN OR USE OF A REMOTE CONTROL SYSTEM OR DEVICE EMPLOYING LINX TECHNOLOGIES RF PRODUCTS.

The limitations on LinX Technologies' liability are applicable to any and all claims or theories of recovery asserted by Customer, including, without limitation, breach of contract, breach of warranty, strict liability, or negligence. Customer assumes all liability (including, without limitation, liability for injury to person or property, economic loss, or business interruption) for all claims, including claims from third parties, arising from the use of the Products. Under no conditions will LinX Technologies be responsible for losses arising from the use or failure of the device in any application, other than the repair, replacement, or refund limited to the original product purchase price. Devices described in this publication may contain proprietary, patented, or copyrighted techniques, components, or materials.