

Single Phase Rectifier Bridge

$I_{dAVM} = 50 \text{ A}$
 $V_{RRM} = 800-1800 \text{ V}$

V_{RSM} V	V_{RRM} V	Type
800	800	VBO 50-08NO7
1200	1200	VBO 50-12NO7
1400	1400	VBO 50-14NO7
1600	1600	VBO 50-16NO7
1800	1800	VBO 50-18NO7*

* delivery time on request

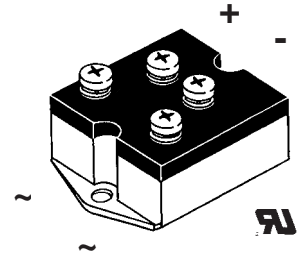
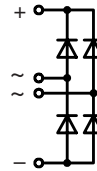

Symbol	Conditions	Maximum Ratings
I_{dAVM}	$T_C = 64^\circ\text{C}$, module	50 A
I_{FSM}	$T_{VJ} = 45^\circ\text{C}$; $V_R = 0$	t = 10 ms (50 Hz), sine 750 A t = 8.3 ms (60 Hz), sine 820 A
	$T_{VJ} = T_{VJM}$ $V_R = 0$	t = 10 ms (50 Hz), sine 670 A t = 8.3 ms (60 Hz), sine 740 A
I^2t	$T_{VJ} = 45^\circ\text{C}$ $V_R = 0$	t = 10 ms (50 Hz), sine 2800 A ² s t = 8.3 ms (60 Hz), sine 2820 A ² s
	$T_{VJ} = T_{VJM}$ $V_R = 0$	t = 10 ms (50 Hz), sine 2250 A ² s t = 8.3 ms (60 Hz), sine 2300 A ² s
T_{VJ}		-40...+150 °C
T_{VJM}		150 °C
T_{stg}		-40...+150 °C
V_{ISOL}	50/60 Hz, RMS $I_{ISOL} \leq 1 \text{ mA}$	t = 1 min 2500 V~ t = 1 s 3000 V~
	M_d	Mounting torque (M5) 5 ±15% Nm 44 ±15% lb.in. Terminal connection torque (M5) 3 ±15% Nm 26 ±15% lb.in.
Weight	typ.	260 g

Features

- Package with screw terminals
- Isolation voltage 3000 V~
- Planar passivated chips
- Blocking voltage up to 1800 V
- Low forward voltage drop
- UL registered E 72873

Applications

- Supplies for DC power equipment
- Input rectifiers for PWM inverter
- Battery DC power supplies
- Field supply for DC motors

Advantages

- Easy to mount with two screws
- Space and weight savings
- Improved temperature and power cycling

Dimensions in mm (1 mm = 0.0394")

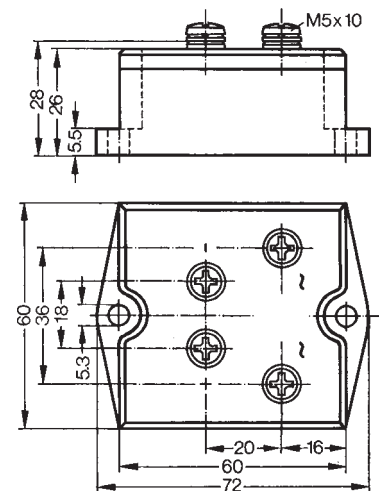

Symbol	Conditions	Characteristic Values
I_R	$V_R = V_{RRM}$; $T_{VJ} = 25^\circ\text{C}$	$\leq 0.3 \text{ mA}$
	$V_R = V_{RRM}$; $T_{VJ} = T_{VJM}$	$\leq 10.0 \text{ mA}$
V_F	$I_F = 150 \text{ A}$; $T_{VJ} = 25^\circ\text{C}$	$\leq 1.6 \text{ V}$
V_{T0}	For power-loss calculations only	0.85 V
r_T	$T_{VJ} = T_{VJM}$	8 mΩ
R_{thJC}	per diode; DC current	2.6 KW
	per module	0.65 KW
R_{thJK}	per diode; DC current	2.84 KW
	per module	0.71 KW

Data according to IEC 60747 refer to a single diode unless otherwise stated.

IXYS reserves the right to change limits, test conditions and dimensions.

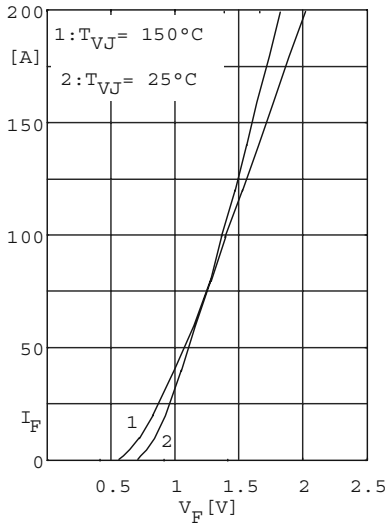

Fig. 1 Forward current versus voltage drop per diode

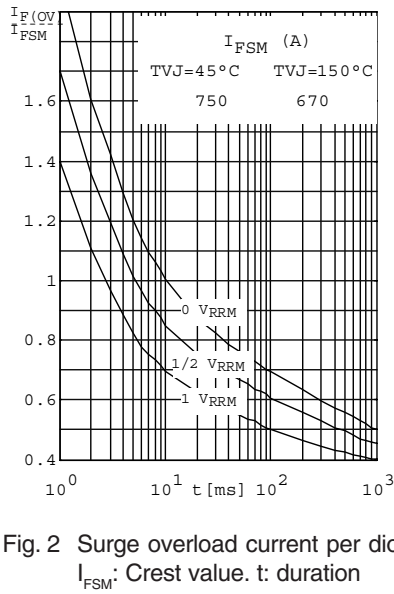

Fig. 2 Surge overload current per diode
 I_{FSM} : Crest value. t: duration

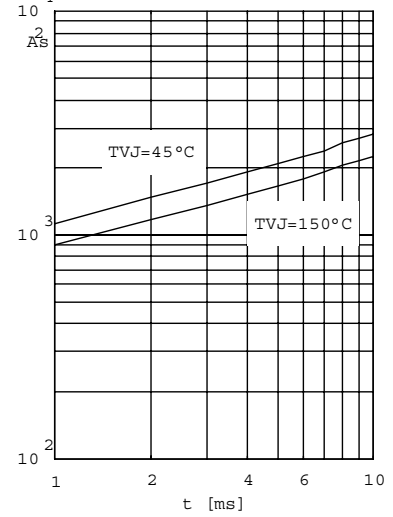

Fig. 3 $\int i^2 dt$ versus time (1-10ms) per diode or thyristor

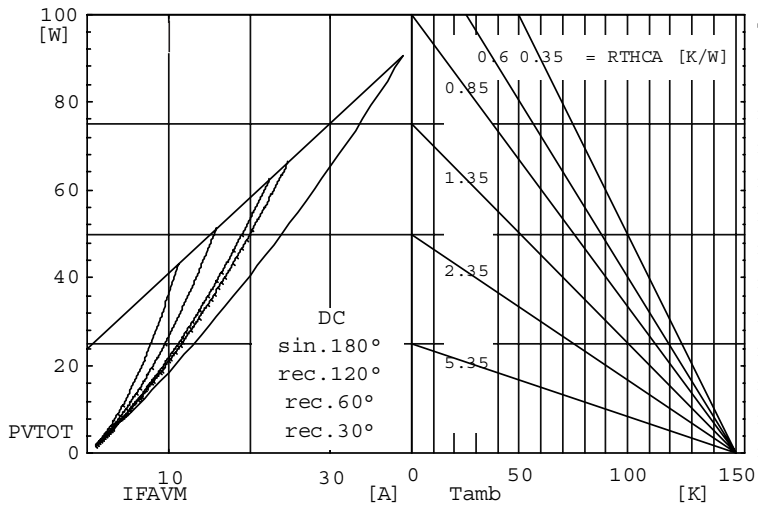

Fig. 4 Power dissipation versus direct output current and ambient temperature

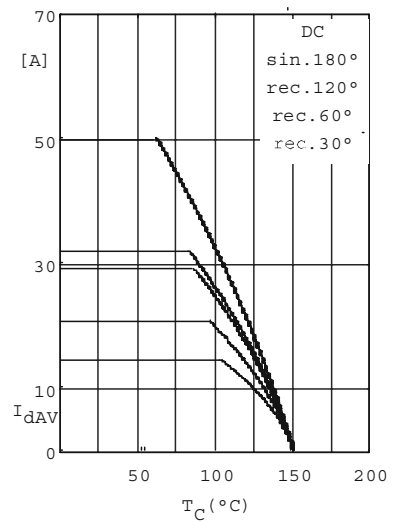

Fig.5 Maximum forward current at case temperature

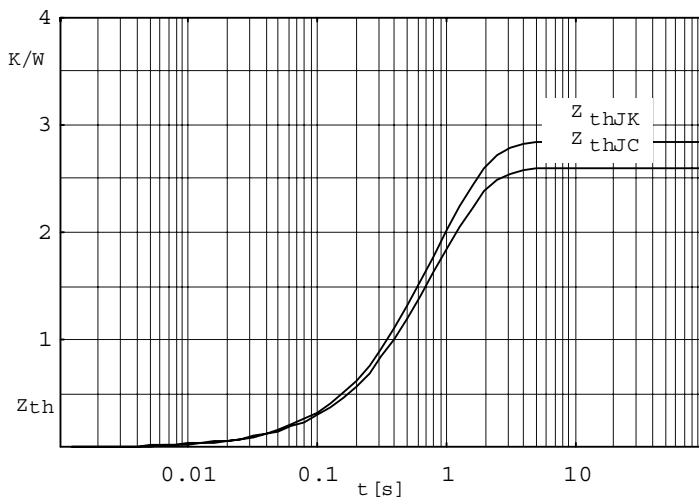

Fig. 6 Transient thermal impedance per diode or thyristor, calculated

Mouser Electronics

Authorized Distributor

Click to View Pricing, Inventory, Delivery & Lifecycle Information:

[IXYS:](#)

[VBO50-08NO7](#) [VBO50-12NO7](#) [VBO50-16NO7](#) [VBO50-18NO7](#)