

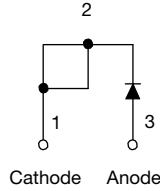

Fast Soft Recovery Rectifier Diode, 10 A



FEATURES

- Glass passivated pellet chip junction
- 150 °C max. operation junction temperature
- Designed and qualified according to JEDEC®-JESD 47
- Fully isolated package ($V_{INS} = 2500 V_{RMS}$)
- UL E78996 approved
- Material categorization: for definitions of compliance please see www.vishay.com/doc?99912



PRODUCT SUMMARY	
Package	TO-220FP
$I_{F(AV)}$	10 A
V_R	200 V, 400 V, 600 V
V_F at I_F	1.2 V
I_{FSM}	160 A
t_{rr}	50 ns
T_J max.	150 °C
Diode variation	Single die
Snap factor	0.5

APPLICATIONS

These devices are intended for use in output rectification and freewheeling in inverters, choppers and converters as well as in input rectification where severe restrictions on conducted EMI should be met.

DESCRIPTION

The VS-10ETF0..FP... fast soft recovery rectifier series has been optimized for combined short reverse recovery time and low forward voltage drop.

The glass passivation ensures stable reliable operation in the most severe temperature and power cycling conditions.

MAJOR RATINGS AND CHARACTERISTICS			
SYMBOL	CHARACTERISTICS	VALUES	UNITS
V_{RRM}		200 to 600	V
$I_{F(AV)}$	Sinusoidal waveform	10	A
I_{FSM}		160	
t_{rr}	1 A, 100 A/ μ s	50	ns
V_F	10 A, $T_J = 25\text{ }^\circ\text{C}$	1.2	V
T_J		-40 to +150	°C

VOLTAGE RATINGS			
PART NUMBER	V_{RRM} , MAXIMUM PEAK REVERSE VOLTAGE V	V_{RSM} , MAXIMUM NON-REPETITIVE PEAK REVERSE VOLTAGE V	I_{RRM} AT 150 °C mA
VS-10ETF02FPPbF, VS-10ETF02FP-M3	200	300	3
VS-10ETF04FPPbF, VS-10ETF04FP-M3	400	500	
VS-10ETF06FPPbF, VS-10ETF06FP-M3	600	700	



ABSOLUTE MAXIMUM RATINGS				
PARAMETER	SYMBOL	TEST CONDITIONS	VALUES	UNITS
Maximum average forward current	$I_{F(AV)}$	$T_C = 98\text{ }^\circ\text{C}$, 180° conduction half sine wave	10	A
Maximum peak one cycle non-repetitive surge current	I_{FSM}	10 ms sine pulse, rated V_{RRM} applied	150	
		10 ms sine pulse, no voltage reapplied	160	
Maximum I^2t for fusing	I^2t	10 ms sine pulse, rated V_{RRM} applied	112.5	A^2s
		10 ms sine pulse, no voltage reapplied	160	
Maximum $I^2\sqrt{t}$ for fusing	$I^2\sqrt{t}$	$t = 0.1$ to 10 ms, no voltage reapplied	1600	$A^2\sqrt{s}$

ELECTRICAL SPECIFICATIONS				
PARAMETER	SYMBOL	TEST CONDITIONS	VALUES	UNITS
Maximum forward voltage drop	V_{FM}	10 A, $T_J = 25\text{ }^\circ\text{C}$	1.2	V
Forward slope resistance	r_t	$T_J = 150\text{ }^\circ\text{C}$	23.5	$m\Omega$
Threshold voltage	$V_{F(TO)}$		0.85	V
Maximum reverse leakage current	I_{RM}	$T_J = 25\text{ }^\circ\text{C}$	0.1	mA
		$T_J = 150\text{ }^\circ\text{C}$	3.0	

RECOVERY CHARACTERISTICS				
PARAMETER	SYMBOL	TEST CONDITIONS	VALUES	UNITS
Reverse recovery time	t_{rr}	I_F at 10 A _{pk} 25 A/ μ s 25 °C	200	ns
Reverse recovery current	I_{rr}		2.75	A
Reverse recovery charge	Q_{rr}		0.32	μ C
Snap factor	S		0.6	

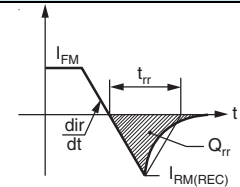

THERMAL - MECHANICAL SPECIFICATIONS				
PARAMETER	SYMBOL	TEST CONDITIONS	VALUES	UNITS
Maximum junction and storage temperature range	T_J, T_{Stg}		-40 to +150	$^\circ\text{C}$
Maximum thermal resistance junction to case	R_{thJC}	DC operation	2.5	$^\circ\text{C/W}$
Maximum thermal resistance junction to ambient	R_{thJA}		62	
Typical thermal resistance, case to heatsink	R_{thCS}	Mounting surface, smooth, and greased	0.5	
Approximate weight			2	g
			0.07	oz.
Mounting torque	minimum		6 (5)	kgf · cm (lbf · in)
	maximum		12 (10)	
Marking device		Case style TO-220 FULL-PAK	10ETF02FP 10ETF04FP 10ETF06FP	

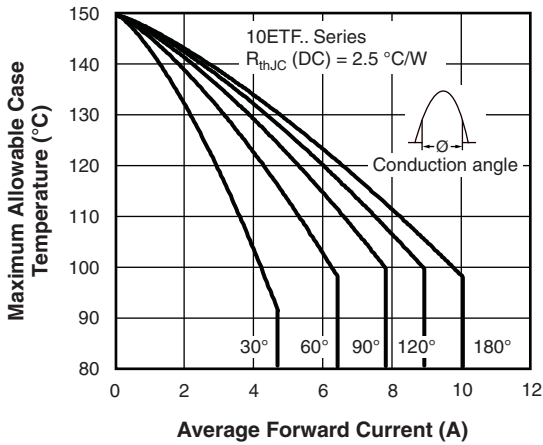

Fig. 1 - Current Rating Characteristics

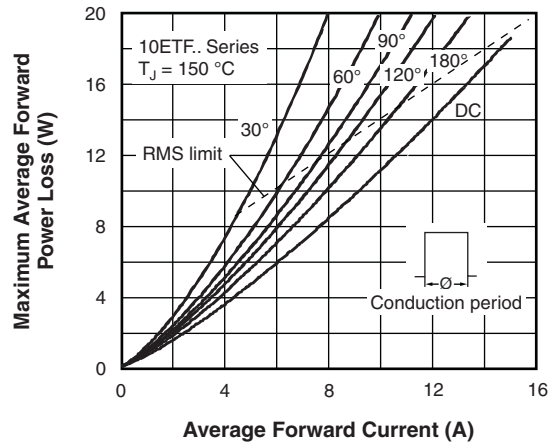

Fig. 4 - Forward Power Loss Characteristics

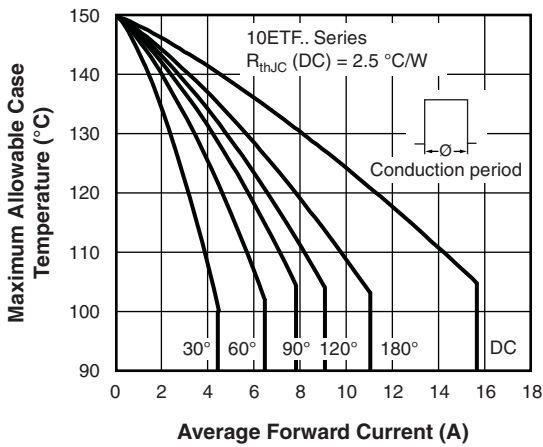

Fig. 2 - Current Rating Characteristics

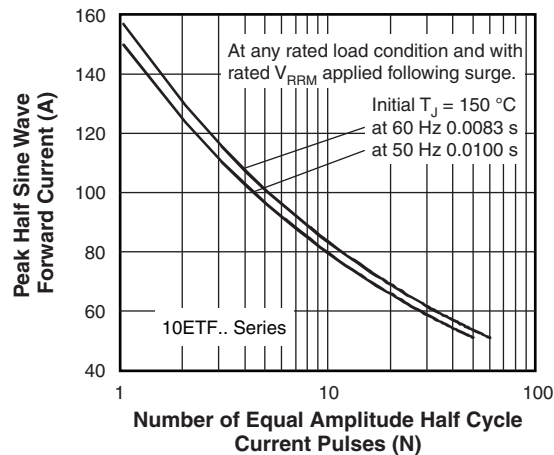

Fig. 5 - Maximum Non-Repetitive Surge Current

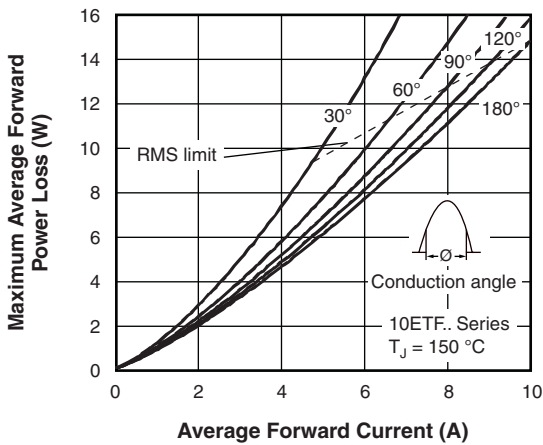

Fig. 3 - Forward Power Loss Characteristics

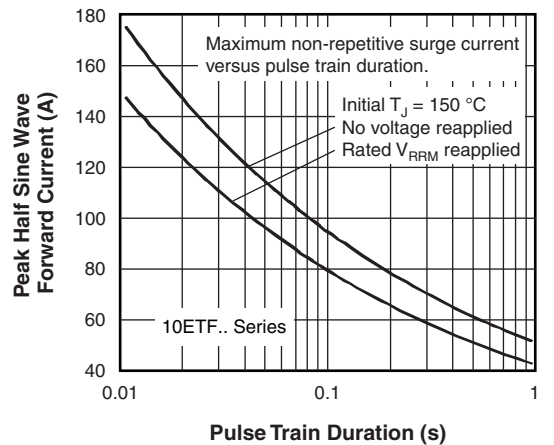

Fig. 6 - Maximum Non-Repetitive Surge Current

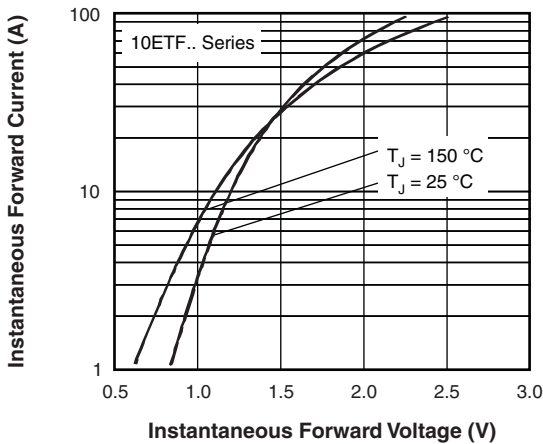

Fig. 7 - Forward Voltage Drop Characteristics

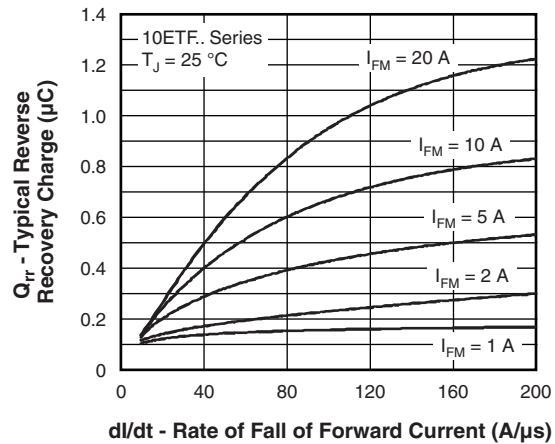

Fig. 10 - Recovery Charge Characteristics, $T_J = 25\text{ }^\circ\text{C}$

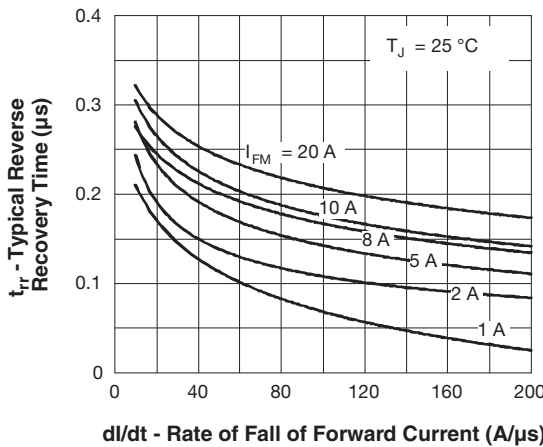

Fig. 8 - Recovery Time Characteristics, $T_J = 25\text{ }^\circ\text{C}$

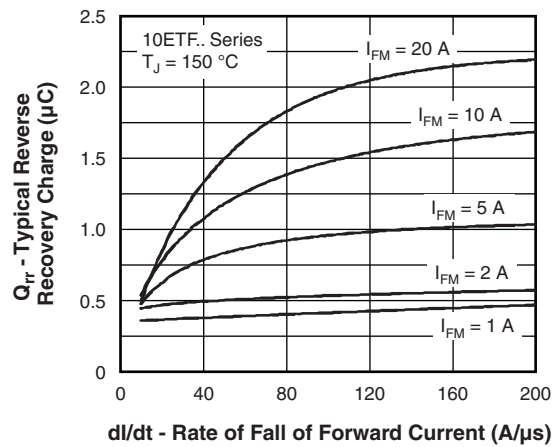

Fig. 11 - Recovery Charge Characteristics, $T_J = 150\text{ }^\circ\text{C}$

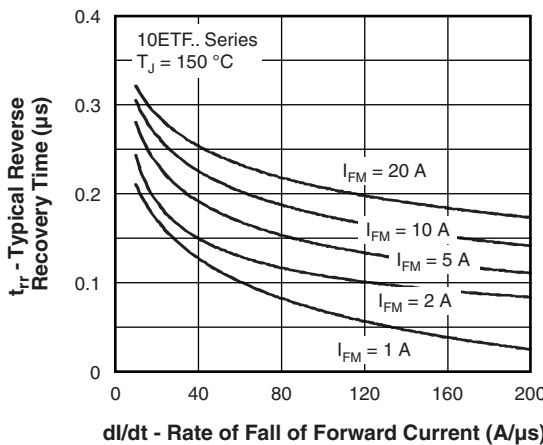

Fig. 9 - Recovery Time Characteristics, $T_J = 150\text{ }^\circ\text{C}$

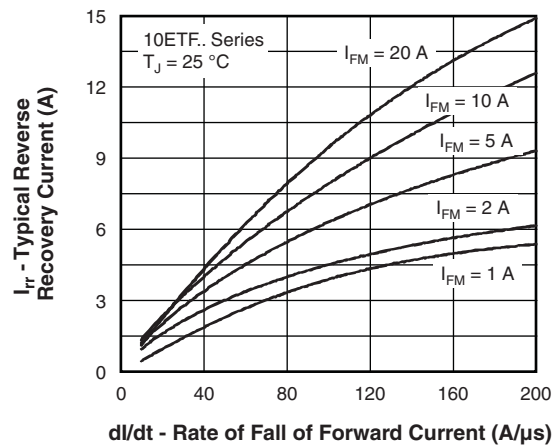

Fig. 12 - Recovery Current Characteristics, $T_J = 25\text{ }^\circ\text{C}$

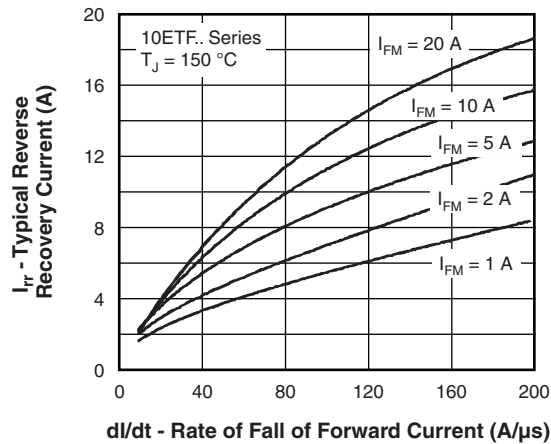

Fig. 13 - Recovery Current Characteristics, $T_J = 150\text{ }^\circ\text{C}$

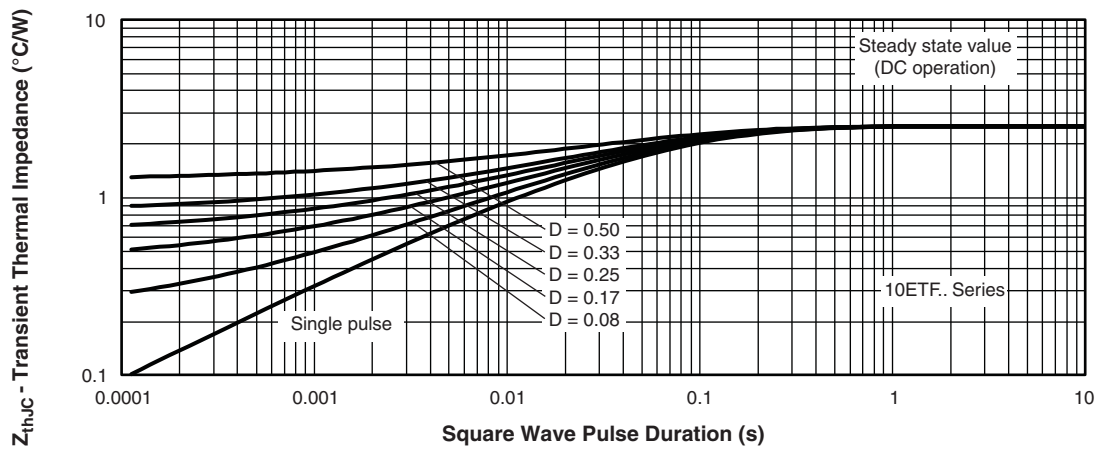
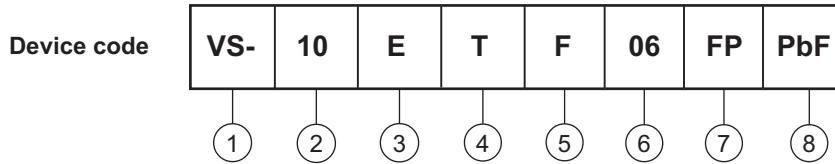

Fig. 14 - Thermal Impedance Z_{thJC} Characteristics



ORDERING INFORMATION TABLE



- 1** - Vishay Semiconductors product
- 2** - Current rating (10 = 10 A)
- 3** - Circuit configuration:
E = single diode
- 4** - Package:
T = TO-220
- 5** - Type of silicon:
F = fast soft recovery rectifier
- 6** - Voltage code x 100 = V_{RRM}

02 = 200 V
04 = 400 V
06 = 600 V
- 7** - FULL-PAK
- 8** - Environmental digit:
 - PbF = lead (Pb)-free and RoHS-compliant
 - -M3 = halogen-free, RoHS-compliant, and terminations lead (Pb)-free

ORDERING INFORMATION (Example)			
PREFERRED P/N	QUANTITY PER T/R	MINIMUM ORDER QUANTITY	PACKAGING DESCRIPTION
VS-10ETF02FPPbF	50	1000	Antistatic plastic tubes
VS-10ETF02FP-M3	50	1000	Antistatic plastic tubes
VS-10ETF04FPPbF	50	1000	Antistatic plastic tubes
VS-10ETF04FP-M3	50	1000	Antistatic plastic tubes
VS-10ETF06FPPbF	50	1000	Antistatic plastic tubes
VS-10ETF06FP-M3	50	1000	Antistatic plastic tubes

LINKS TO RELATED DOCUMENTS	
Dimensions	www.vishay.com/doc?95005
Part marking information	TO-220 FP PbF www.vishay.com/doc?95009
	TO-220 FP -M3 www.vishay.com/doc?95440



DIMENSIONS in millimeters

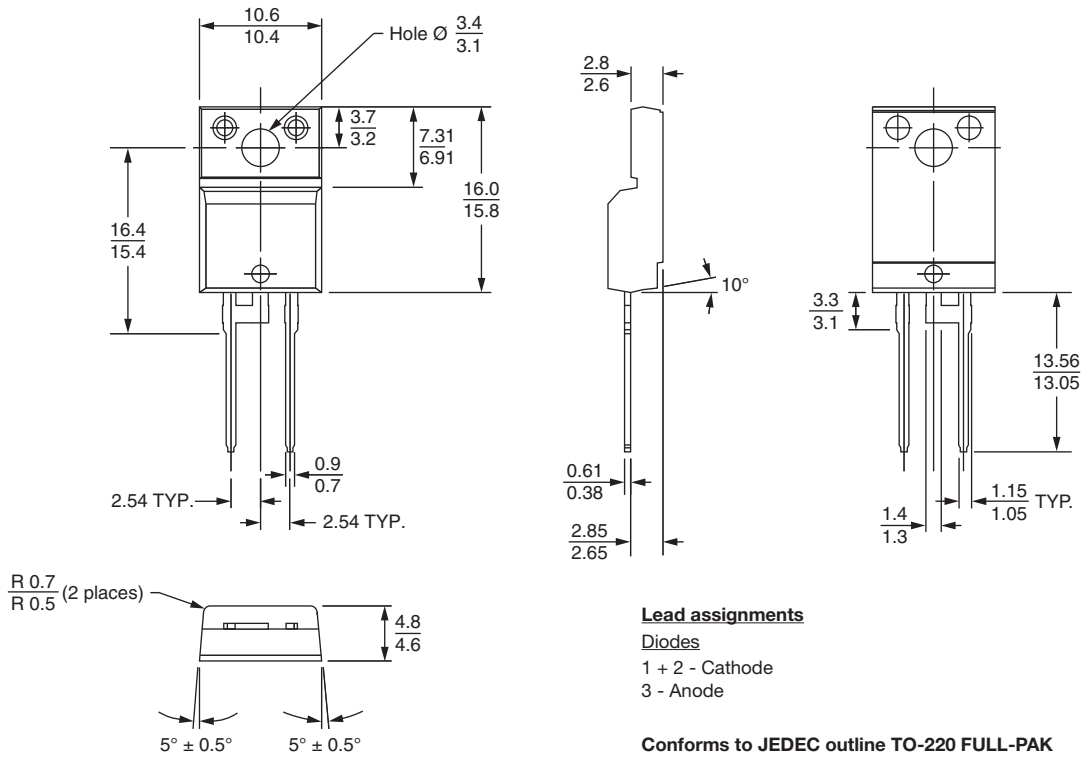

Lead assignments

- Diodes**
1 + 2 - Cathode
3 - Anode

Conforms to JEDEC outline TO-220 FULL-PAK



Disclaimer

ALL PRODUCT, PRODUCT SPECIFICATIONS AND DATA ARE SUBJECT TO CHANGE WITHOUT NOTICE TO IMPROVE RELIABILITY, FUNCTION OR DESIGN OR OTHERWISE.

Vishay Intertechnology, Inc., its affiliates, agents, and employees, and all persons acting on its or their behalf (collectively, "Vishay"), disclaim any and all liability for any errors, inaccuracies or incompleteness contained in any datasheet or in any other disclosure relating to any product.

Vishay makes no warranty, representation or guarantee regarding the suitability of the products for any particular purpose or the continuing production of any product. To the maximum extent permitted by applicable law, Vishay disclaims (i) any and all liability arising out of the application or use of any product, (ii) any and all liability, including without limitation special, consequential or incidental damages, and (iii) any and all implied warranties, including warranties of fitness for particular purpose, non-infringement and merchantability.

Statements regarding the suitability of products for certain types of applications are based on Vishay's knowledge of typical requirements that are often placed on Vishay products in generic applications. Such statements are not binding statements about the suitability of products for a particular application. It is the customer's responsibility to validate that a particular product with the properties described in the product specification is suitable for use in a particular application. Parameters provided in datasheets and / or specifications may vary in different applications and performance may vary over time. All operating parameters, including typical parameters, must be validated for each customer application by the customer's technical experts. Product specifications do not expand or otherwise modify Vishay's terms and conditions of purchase, including but not limited to the warranty expressed therein.

Except as expressly indicated in writing, Vishay products are not designed for use in medical, life-saving, or life-sustaining applications or for any other application in which the failure of the Vishay product could result in personal injury or death. Customers using or selling Vishay products not expressly indicated for use in such applications do so at their own risk. Please contact authorized Vishay personnel to obtain written terms and conditions regarding products designed for such applications.

No license, express or implied, by estoppel or otherwise, to any intellectual property rights is granted by this document or by any conduct of Vishay. Product names and markings noted herein may be trademarks of their respective owners.

Mouser Electronics

Authorized Distributor

Click to View Pricing, Inventory, Delivery & Lifecycle Information:

[Vishay:](#)

[VS-10ETF02FPPBF](#) [VS-10ETF06FPPBF](#) [VS-10ETF04FPPBF](#)