

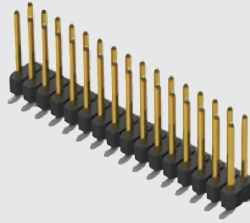

TSM-116-02-S-DV-LC

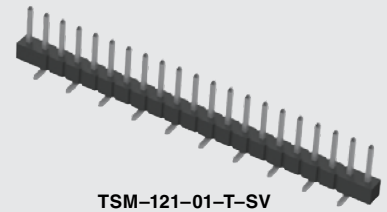

TSM-121-01-T-SV



(2.54 mm) .100"

# SMT .025" SQ POST HEADER

**Board Mates:**

SSW, SSQ, SSM, BSW, ESW, ESQ, BCS, SLW, CES, HLE

**Cable Mates:**

IDSS, IDSD, SMSD, SMSS

**SPECIFICATIONS**

For complete specifications and recommended PCB layouts see [www.samtec.com?TSM](http://www.samtec.com?TSM)

**Insulator Material:**

Black Liquid Crystal Polymer

**Terminal Material:**

Phosphor Bronze

**Plating:**

Au or Sn over 50 μm (1.27 μm) Ni

**Operating Temp Range:**

-55 °C to +105 °C with Tin;

-55 °C to +125 °C with Gold

**Voltage Rating:**

475 VAC -SV/-DV mated with BCS or SSM

**RoHS Compliant:**

Yes

**Lead-Free Solderable:**

Yes

**-DH/-SH Lead Coplanarity:**

(0.15 mm) .006" max (02-36)

**-DV/-SV Lead Coplanarity:**

(0.10 mm) .004" max (02-05)

(0.13 mm) .005" max (06-10)

(0.15 mm) .006" max (11-36)

MATES	CURRENT RATING (PER PIN)
TSM/SSW	4.9 A
TSM/SSM	5.4 A
TSM/HLE	4.1 A
<b>1 PIN POWERED PER ROW</b>	

**RECOGNITIONS**

For complete scope of recognitions see [www.samtec.com/quality](http://www.samtec.com/quality)



**ALSO AVAILABLE (MOQ Required)**

- Edge Mount and Locking Clips for -SV
  - Solder Locks for -DH and Shrouds for -DV
  - Other platings
- Contact Samtec.

**Note:** Some lengths, styles and options are non-standard, non-returnable.

<b>TSM</b>	<b>1</b>	<b>NO. PINS PER ROW</b>	<b>LEAD STYLE</b>	<b>PLATING OPTION</b>	<b>ROW OPTION</b>
		<b>02 thru 36</b>		<b>-F</b> = Gold flash on post, Matte Tin on tail	
				<b>-L</b> = 10 μm (0.25 μm) Gold on post, Matte Tin on tail	
				<b>-S</b> = 30 μm (0.76 μm) Gold on post, Matte Tin on tail	
				<b>-T</b> = Matte Tin	

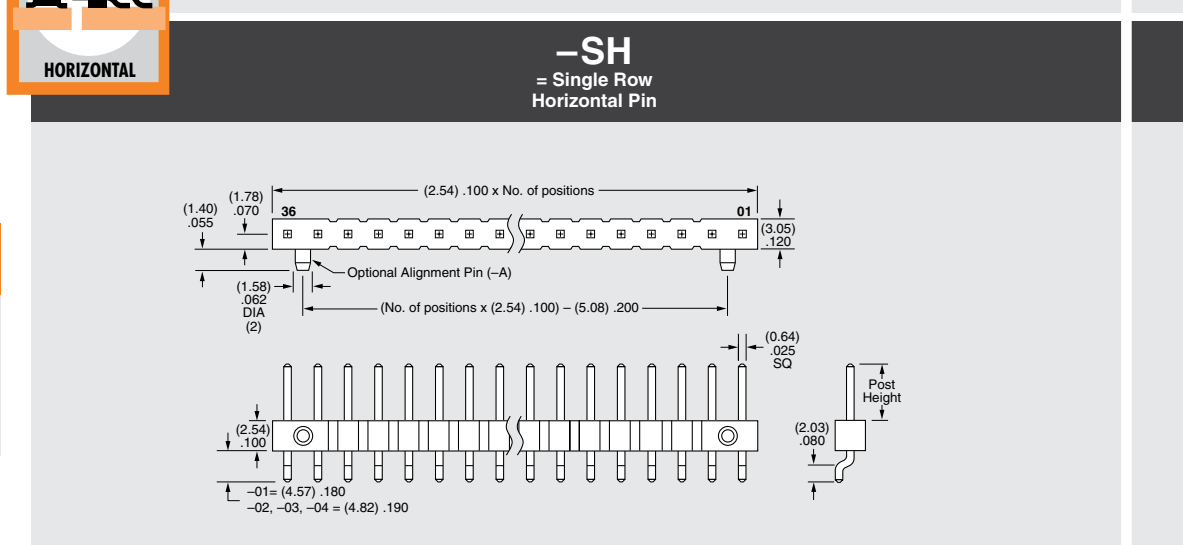
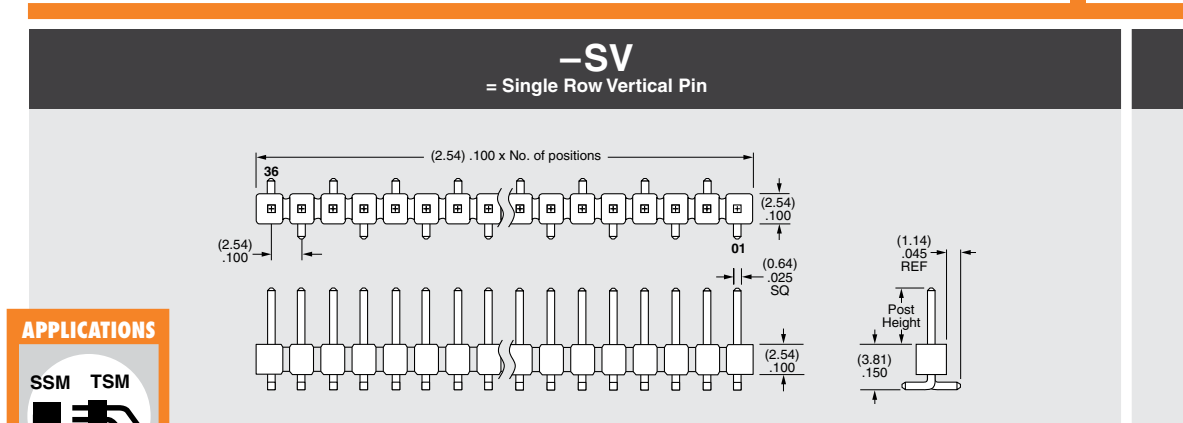
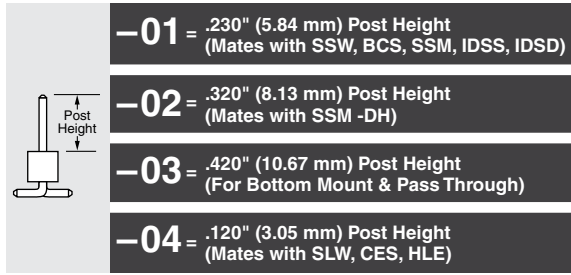

**APPLICATIONS**

SSM TSM

**HORIZONTAL**

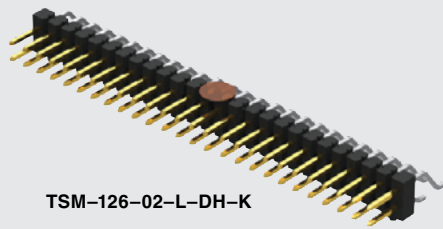

TSM-126-02-L-DH-K

TSM-115-01-T-SH-A

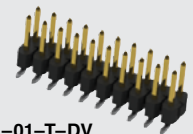
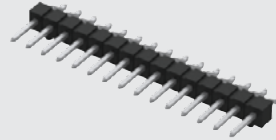

TSM-110-01-T-DV

**TSM SERIES**

**OTHER OPTIONS**

**-A**

= Alignment Pin metal or plastic at Samtec discretion (Not available with -TM or -MT) (02 positions min.) (Not available with -LC)

**-LC**

= Locking Clip (Not available with -TM) (3 positions min.) (Not available with -A) (Manual placement required)

**-K**

= (6.50 mm) .256" DIA Polyimide Film Pick & Place Pad (-SH: 4 positions minimum without -TR; 2 & 3 positions available with -TR)

(-DH: 4 positions minimum without -TR)

**“XXX”**  
= Polarized Position

**-P**

= Plastic Pick & Place Pad (-DV: 4 positions minimum without -TR; 2 & 3 positions available with -TR)

(-SH: 4 positions minimum without -TR; 2 & 3 positions available with -TR)

(-DH: 5 positions minimum without -TR)

(-SV: 4 positions minimum without -TR; 2 & 3 positions available with -TR)

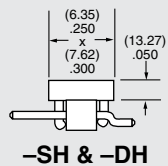
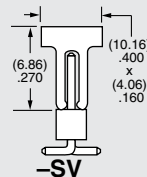

**-TR**

= Tape & Reel Packaging  
-SV = 02-22 positions  
-DV = 02-28 positions  
-SH = 02-30 positions  
-DH = 02-29 positions

Not available with -MT or -TM

**-DV**

= Double Row Vertical Pin

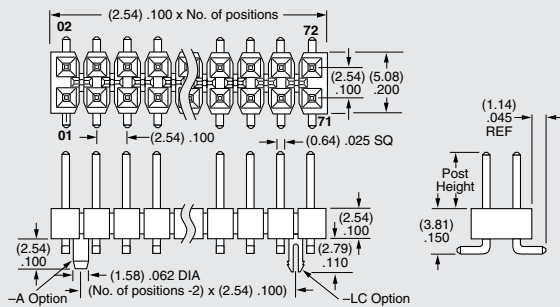

**-TM**

= Triple Row Vertical Mixed Technology (Style -01 only)

02 thru 30 positions only

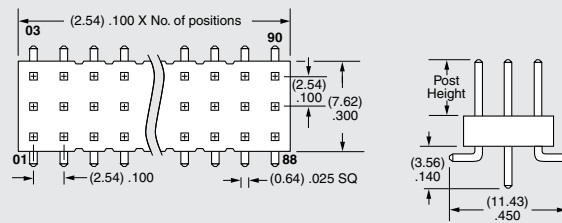

**-DH**

= Double Row Horizontal Pin (Style -01, -02 or -03 only)

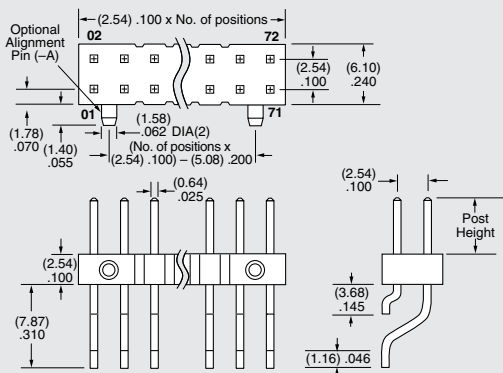

**-MT**

= Mixed Technology Pin (Style -01, -02 or -03 only)

