

2006

rev.1

Data Book

Ultra-precision & Ultra-reliability

Thin Film Chip Resistors

RG Series

RM Series

RGH Series

SSM
THIN FILM TECHNOLOGY
SUSUMU CO., LTD.

● Market needs and Product Characteristics3
● Specifications4, 5
● Reliability Test Data	
Reliability Test Result in 10000 hrs6
Temperature resistance in 10000 hrs7
Sulfur resistance8
Durability against pulse8
● Electrical Features Data	
Excellent resistance stability (little secular distortion)9
Temperature Coefficient of Resistance (TCR)9
Low current noise10
High frequency Characteristics10
● Environmental Data11
● Design Supportive Data	
Recommended land pattern12
Power Derating12
Recommended Reflow12
Tape Specification13
Reel Specification13
● Process Flow Chart14
● Resistance Value Series, Remarks15
● SUSUMU Group Sales Networks16

RG series

Highly reliable, highly stable

- Highly reliable resistors are needed in application for automotive electronics, FA instruments, and industrial test and measurement equipment due to their exposure to harsh environments. In the proximity of automotive engines with their high temperature, high humidity, dusts, vibration and hazardous chemicals, resistors with long lasting reliability and with exceptional tolerance against heat, humidity and sulfur are especially necessary.
- In consumer electronics, reliable components are required because long-term warranty is considered as an added value.
 - Various reliability tests: high reliability with $\pm 0.1\%$ or less drift after 10000 hours.
 - Operating temperature: $-55\sim 155^{\circ}\text{C}$; extremely heat resistant
 - Resistant to humidity: new passivation can block moisture even in very humid environment.
 - Resistance to sulfur: no silver in the terminals and passivation with strong chemical resistance.
 - Resistance to pulse voltage/current: resistant to ESD and surge current.

Low cost

- The performance and reliability characteristics match foil resistors but are priced more reasonably.

High precision, high performance

- High functionality of the latest equipment requires resistors with the tightest tolerance especially in voltage divider or amplifier gain in analogue circuits.
 - Realized very tight resistance tolerance: $\pm 0.02\%$.
- In order not to be affected by fluctuating environmental conditions, resistors with minimal Temperature Coefficient of Resistance (TCR) are required.
 - Realized very small TCR: $\pm 5\text{ppm}/^{\circ}\text{C}$.
- In the amplification of very weak signals, resistors with the lowest current noise of its own is required. in order not to affect the dynamic range.
 - Realized low current noise: -20dB
- In high frequency circuits, resistors without any resonance at certain frequencies and with stability throughout wide frequency ranges are needed.
 - Realized stable frequency performance.

Friendly to environment

- "Thin Film" resistors are environmentally friendly.
- Long-term reliability and small dimensions help conserve resources.
- Compliant to RoHS and completely lead free.

RM series

Network

Multi-element network of "RG" series resistor elements with all the exceptional reliability, stability, precision, and performance of the RG series.

- All elements are formed side by side on the same substrate allowing excellent matching characteristics, which will contribute to the high performance and functionality of the user application.
 - Ratio (matching) resistance tolerance: $\pm 0.01\%$.
 - Ratio (matching) TCR: $\pm 1\text{ppm}/^{\circ}\text{C}$.
- Contributes space saving by networking.
- Contributes cost reduction by reducing the number of components.

RGH series

High Power

We have developed high power chip resistors with RG series performance and reliability characteristics.

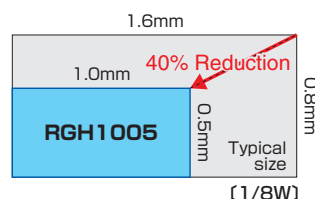

- The trend to be smaller and shorter in electronics makes it mandatory to increase the rated power of the component.
 - Offering 1/8 Watt for 1005 size chip (conventionally 1/8W was offered with 1608chip. Occupying space is only 40% of 1608)
 - Offering 1/4 Watt for 2012 size chip (conventionally 1/4W was offered with 3216chip. Occupying space is only 48% of 3216)

Specifications

Construction

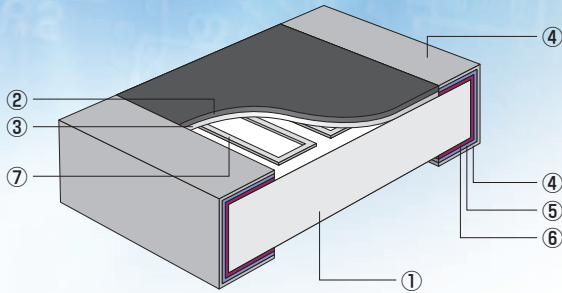

	Name	Material Name
①	Substrate	Alumina ceramic
②	Protection coat I	Resin Coating
③	Protection coat II	Inorganic coating
④	External Electrode	Tin plating (Sn 100%)
⑤	Inner Electrode I	Nickel plating
⑥	Inner Electrode II	Thin film
⑦	Resistive element	Thin film

RG series

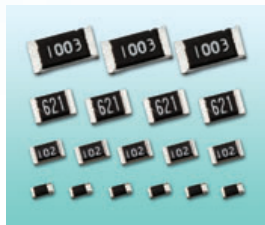

Mechanical

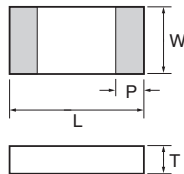

Dimension (Inch Size)	RG1005 (0402)	RG1608 (0603)	RG2012 (0805)	RG3216 (1206)
L	1.0±0.05	1.6±0.2	2.0±0.2	3.2±0.2
W	0.5±0.05	0.8±0.2	1.25±0.2	1.6±0.2
P	0.2±0.10	0.3±0.2	0.4±0.2	0.5±0.25
T	0.35±0.05	0.4±0.1	0.4±0.1	0.4±0.1

(unit : mm)

Electrical

Type	RG1005				RG1608						
Power	general	1/16W				1/10W					
	Ultra-reliability	1/32W				1/16W					
Tolerance %(code)	±0.5(D)	±0.05(W), ±0.1(B) ±0.25(C), ±0.5(D)	±0.02(P), ±0.05(W), ±0.1(B), ±0.25(C), ±0.5(D)	±0.05(W), ±0.1(B) ±0.25(C), ±0.5(D)	±0.5(D)	±0.05(W), ±0.1(B) ±0.25(C), ±0.5(D)	±0.02(P), ±0.05(W), ±0.1(B), ±0.25(C), ±0.5(D)	±0.05(W), ±0.1(B) ±0.25(C), ±0.5(D)	±0.1(B) ±0.5(D)	±0.5(D)	
Resistance Range (Ω)	10~46.4	47~97.6	100~2.94k	3k~100k	10~46.4	47~97.6	100~4.99k	5.1k~270k	274~332k	340~360k	
TCR ppm/°C (code)	±100 (R)	±10 (N) ±25 (P)	±10 (N) ±25 (P)	±10 (N) ±25 (P)	±50 (Q)	±10 (N) ±25 (P)	±10 (N) ±25 (P)	±10 (N) ±25 (P)	±25 (P)	±25 (P)	
Max Operating Voltage	25V				75V						
Resistance Value	E-24, E-96										
Operating Temp. Range	-55°C~155°C										
Package	1,000pcs/reel (T1:P,W), 5,000pcs/reel (T5:B), 10,000pcs/reel (T10:B,C,D)				1,000pcs/reel (T1:P,W,B), 5,000pcs/reel(T5:B,C,D)						

Type	RG2012					RG3216			
Power	general	1/8W					1/4W		
	Ultra-reliability	1/10W					1/8W		
Tolerance %(code)	±0.5(D)	±0.05(W), ±0.1(B) ±0.25(C), ±0.5(D)	±0.02(P), ±0.05(W), ±0.1(B), ±0.25(C), ±0.5(D)	±0.05(W), ±0.1(B) ±0.25(C), ±0.5(D)	±0.1(B) ±0.5(D)	±0.05(W), ±0.1(B) ±0.25(C), ±0.5(D)	±0.02(P), ±0.05(W), ±0.1(B), ±0.25(C), ±0.5(D)	±0.05(W), ±0.1(B) ±0.25(C), ±0.5(D)	
Resistance Range (Ω)	10~46.4	47~97.6	100~10k	10.2k~475k	487k~1M	47~97.6	100~33.2k	34k~1M	
TCR ppm/°C (code)	±50 (Q)	±10 (N) ±25 (P)	±10 (N) ±25 (P)	±10 (N) ±25 (P)	±25 (P)	±10 (N) ±25 (P)	±10 (N) ±25 (P)	±10 (N) ±25 (P)	
Max Operating Voltage	100V					150V			
Resistance Value	E-24, E-96								
Operating Temp. Range	-55°C~155°C								
Package	1,000pcs/reel (T1:P,W,B), 5,000pcs/reel(T5:B,C,D)								

• Please contact us for Resistance tolerance ±0.01%. • Please contact us for RG3226 series with power of 1/2W

Part Number

RG 1608 N - 102 - B - T5

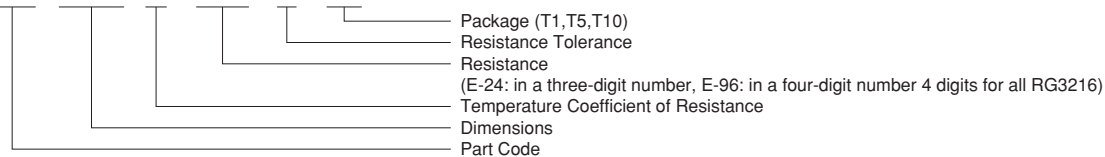

RGH series



Mechanical

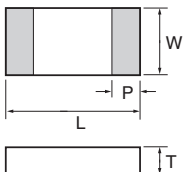

Dimension (Inch Size)	RGH1005-2B	RGH2012-2E
L	1.0±0.05	2.0±0.2
W	0.5±0.05	1.25±0.2
P	0.2±0.10	0.4±0.2
T	0.35±0.05	0.4±0.1

(unit : mm)

Electrical

Type	RGH1005-2B	RGH2012-2E
Power	1/8W	1/4W
Tolerance % (code)	±0.1%(B), ±0.5%(D)	±0.1%(B), ±0.5%(D)
Resistance Range (Ω)	47~100k	47~470k
TCR ppm/°C (code)	±25ppm/°C(P)	±25ppm/°C(P)
Max Operating Voltage	75V	125V
Resistance value	E-24, E-96	E-24, E-96
Operating Temp. Range	-55~155°C	-55~155°C
Package	10,000	5,000

• RGH1608 with 1/6W power consumption are available to meet your needs.

Part Number

RGH 1005 - 2B - P - 102 - B

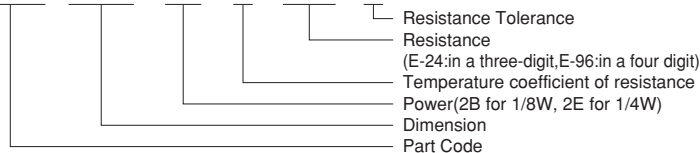

RM series



Mechanical

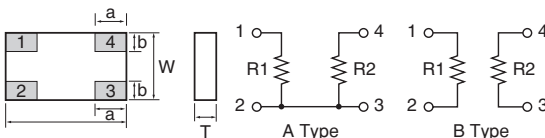

Dimension (Inch Size)	RM2012 (0805)	RM3216 (1206)
L	2.0±0.2	3.2±0.2
W	1.25±0.2	1.6±0.2
T	0.4±0.1	0.4±0.1
a	0.6±0.2	1.0±0.2
b	0.35±0.2	0.4±0.2

(unit : mm)

Electrical

Type	RM 2012		RM 3216	
Power	0.05W/element, 0.1W/package		0.063W/element, 0.125W/package	
Resistance Range (Ω)	100~100k		500~330k	
Absolute Tol. %(code)	±0.1(B), ±0.5(D) (100 ≤ R < 2kΩ)	±0.05(W), 0.1(B), ±0.5(D) (2kΩ ≤ R ≤ 100kΩ)	±0.1(B), ±0.5(D) (100 R < 2kΩ)	±0.05(W), 0.1(B), ±0.5(D) (2kΩ ≤ R < 330kΩ)
Tracking Tol. %(code)	±0.01(L), ±0.02(P), ±0.05(W) (ratio=1) ±0.02(P), ±0.05(W) (1 < ratio ≤ 10) ±0.05(W) (100 ≥ ratio > 10)		±0.01(L), ±0.02(P), ±0.05(W) (ratio=1) ±0.02(P), ±0.05(W) (1 < ratio ≤ 10) ±0.05(W) (100 ≥ ratio > 10)	
Absolute TCR ppm/°C (code)	±25(P) (100 ≤ R < 300Ω)	±10(N), ±25(P) (300 ≤ R ≤ 100kΩ)	±25(P) (100 ≤ R < 300Ω)	±10(N), ±25(P) (300 ≤ R ≤ 330kΩ)
Tracking TCR ppm/°C (code)	±1(X), ±5(V) (ratio=1) ±2(W), ±5(V) (1 < ratio ≤ 3) ±5(V) (100 ≥ ratio > 3)		±1(X), ±5(V) (ratio=1) ±2(W), ±5(V) (1 < ratio ≤ 3) ±5(V) (100 ≥ ratio > 3)	

- Please contact us for TCR ±5ppm/°C for 300Ω or more in RM2012, RM3216
- Standard combination of resistance values
 - Identical resistance values R1=R2=1kΩ, 10kΩ, 100kΩ
 - Different resistance values R1=1kΩ, R2=2kΩ, 3kΩ, 4kΩ, 5kΩ, 6kΩ, 9kΩ, 10kΩ, 20kΩ, 25kΩ, 50kΩ, 100kΩ
 - R1=2kΩ, R2=10kΩ, 20kΩ, 40kΩ, 50kΩ, 100kΩ, 200kΩ
 - R1=10kΩ, R2=20kΩ, 30kΩ, 40kΩ, 50kΩ, 60kΩ, 90kΩ, 100kΩ
- Please contact us for other variety than these sizes and customized specifications.

Part Number

RM 2012 A - ***/** - P W X L 10

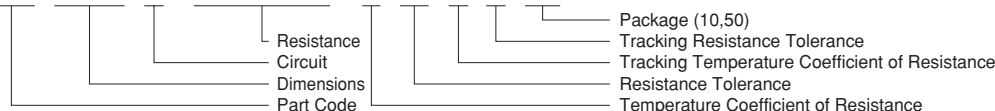

Reliability Test Data

Excellent reliability and stability

- Realized excellent reliability and stability comparable to foil resistors using stable resistive film with minimal long-term drift and exceptional environmental passivation.
- Thin film resistors are traditionally highly stable but the new RG, RM, RGH series promise even longer product life: less than $\pm 0.1\%$ drift after 116 years of usage under normal condition (temperature and humidity)

Humidity resistance 10000 hour 85°C 85% test data on RG/RM

■ RG series

● Moisture and life test (THB 85°C 85%)

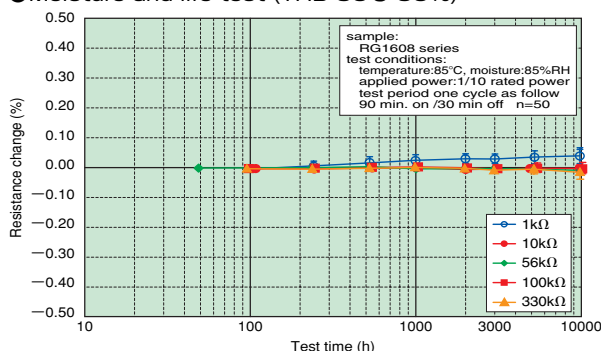

■ RM series

● Temperature Humidity Bias (85°C 85%)

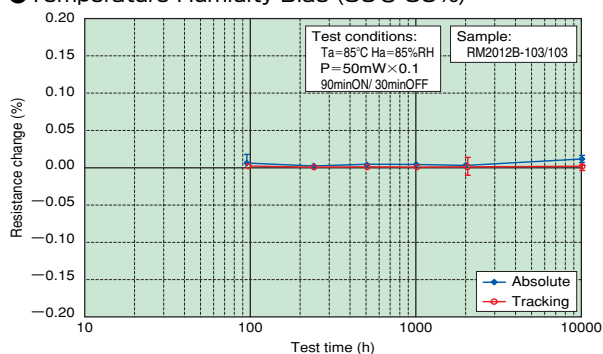

● Temperature Humidity Bias (85°C 85%)

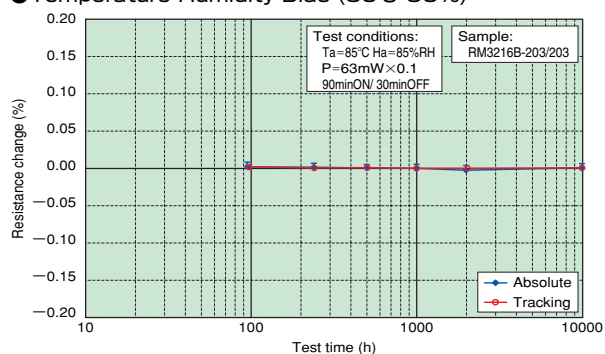

● Moisture Load Life (60°C 95%)

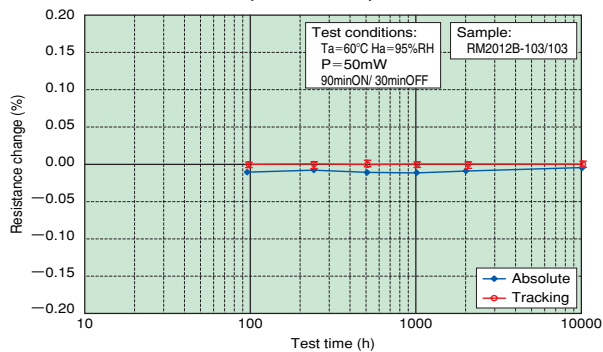

● Moisture Load Life (60°C 95%)

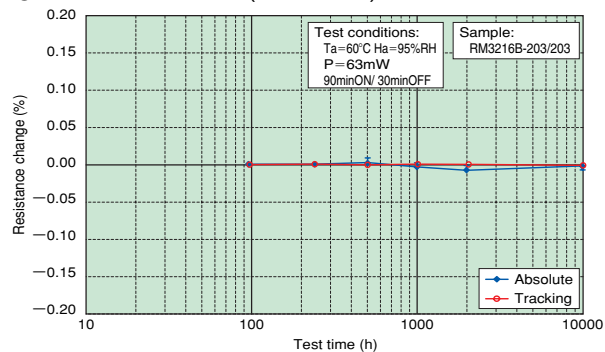

Temperature resistance

RG series

● Temperature cycle test

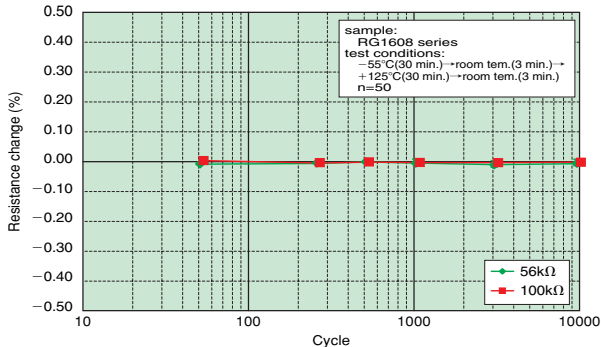

● High temperature expose test (155°C)

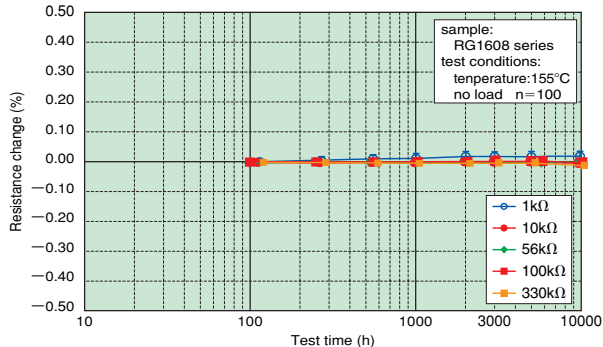

● Load life test (85°C)

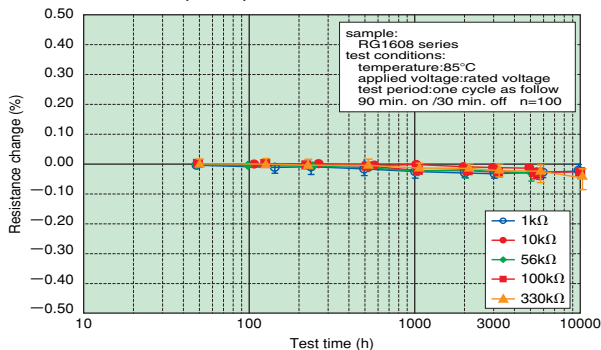

RM series

● Temperature Humidity Bias (85°C 85%)

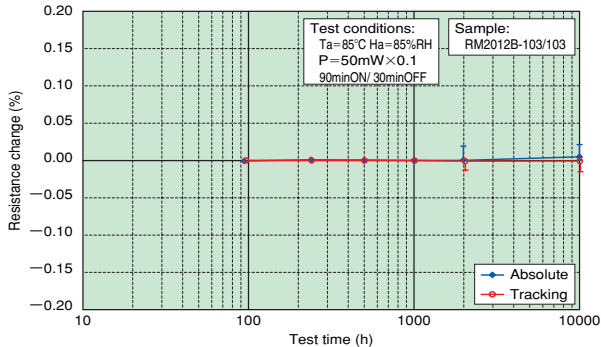

● Temperature Humidity Bias (85°C 85%)

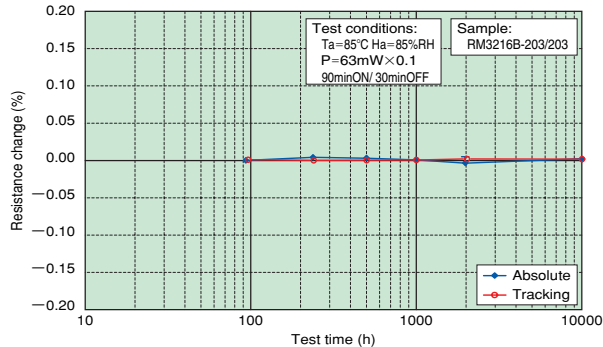

● High Temperature Storage (155°C)

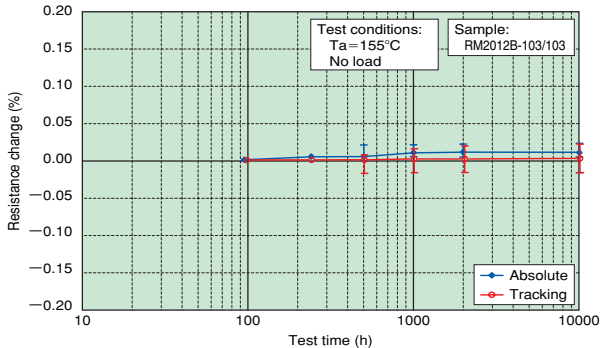

● High Temperature Storage (155°C)

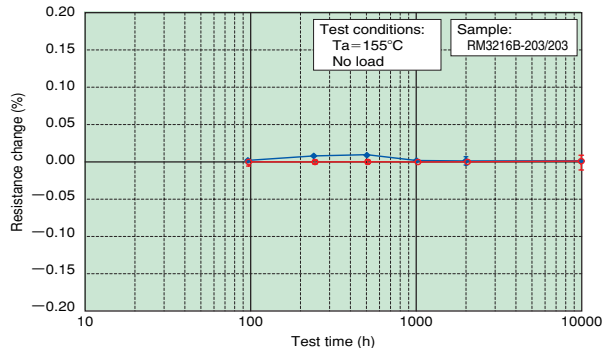

Sulfur resistance

Strong resistance to sulfur with no sulfur sensitive silver content and non-reactive passivation (separate Data)

●Sulfide Gas Test Results

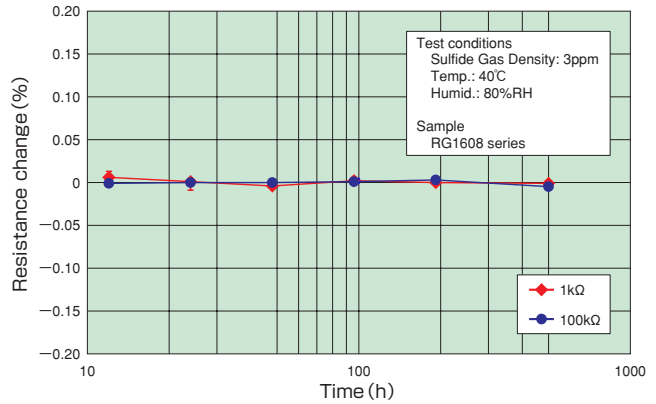

Durability against pulse

Through stable thin film forming processes (resistance element and protection film), resistor has excellent durability against pulse.

■Test Model

[Machine Model]

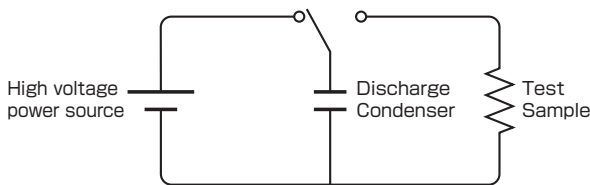

[Human Model]

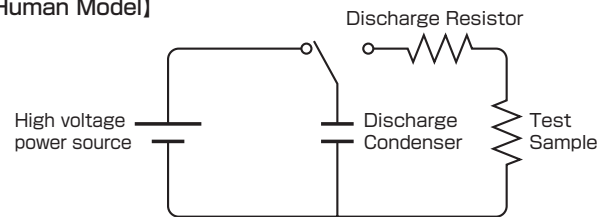

●Little resistance change and stable status in low voltage loaded

●Comparison test of ESD between RG series and Thick film resistor (Machine Model)

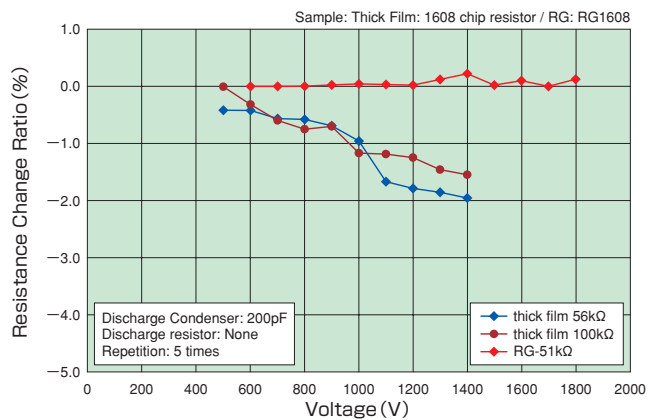

Electrical Features Data

Excellent resistance stability (little secular distortion)

Through stable thin film forming processes and unique annealing treatment (aging), resistance change is minimized durable resistor against environment in long term usage. Resistance change is little even in high temperature and high humidity environment for long term.

Thin Film (Susumu) vs Thick Film (Competitor)

●High Temperature Storage Test 155°C

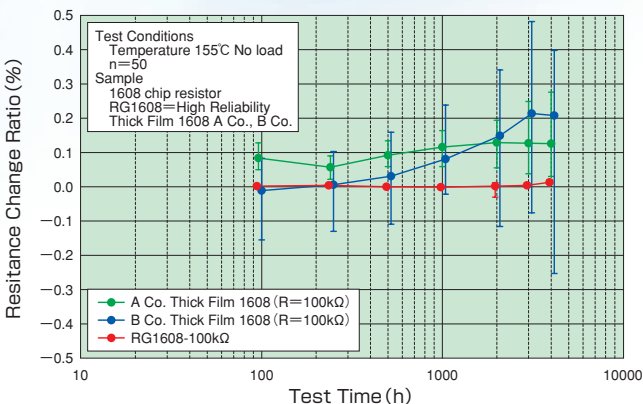

●Temperature Humidity Bias (THB) 85°C 85%

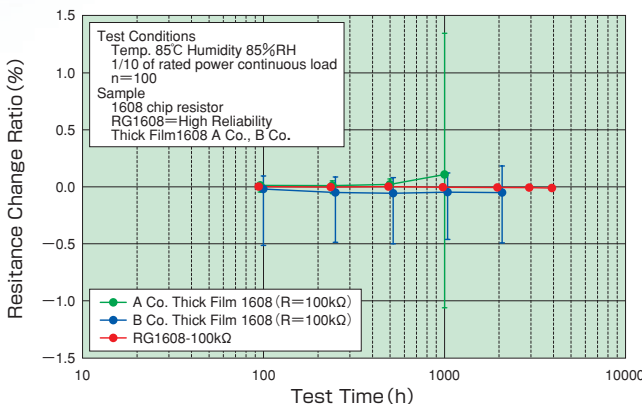

Temperature Coefficient of Resistance (TCR)

Absolute TCR: $\pm 2\text{ppm}/^\circ\text{C}$,
TCR ratio: $\pm 1\text{ppm}/^\circ\text{C}$

●Metals have positive TCR and non or semi-conductors have negative TCR. A thick film resistor is normally a composite of metals and non-conductive materials. It shows positive TCR when the resistance value is high due to its high content of non-conductor and negative TCR when resistance is low with its high metal content. Our thin film resistor, with its proprietary composition and deposition method, shows close to zero TCR regardless the resistance value.

●Temperature Coefficient of Resistance
-Thin Film (Susumu) vs Thick Film (Competitor)-

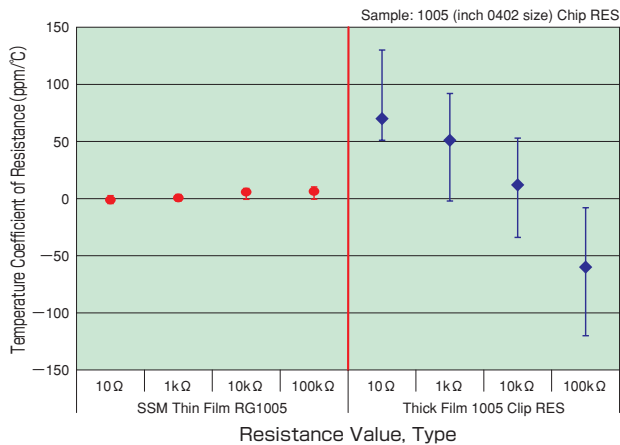

$$\text{TCR}(10^{-6}/\text{K}) = \frac{(R-R_0)}{R_0} \times \frac{(R-R_0)}{t-t_0} \times 10^6$$

where R : measured resistant value at t°C (Ω)
R₀ : measured resistant value at t₀°C (Ω)
t : measured test temperature (°C)
t₀ : measured standard temperature (°C)

Low current noise

Theoretical background

The current noise largely depends on the materials used and becomes significant in lower frequencies. This film tends to suppress the noise (see figure below). Therefore, low current noise thin film chip resistor is needed for the application that handles very low voltage near DC range.

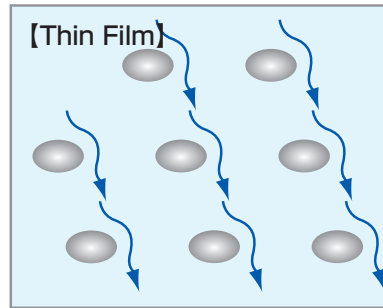

Electrons move smoothly without much dispersion that creates noise.

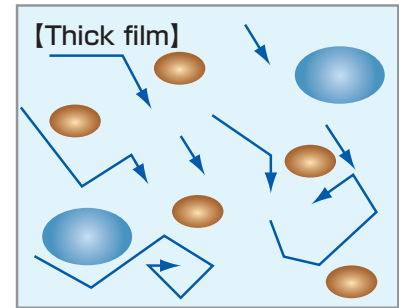

Electron moves randomly creating noise.

Current Noise Features

— Comparison with Thick Film and Thin Film —

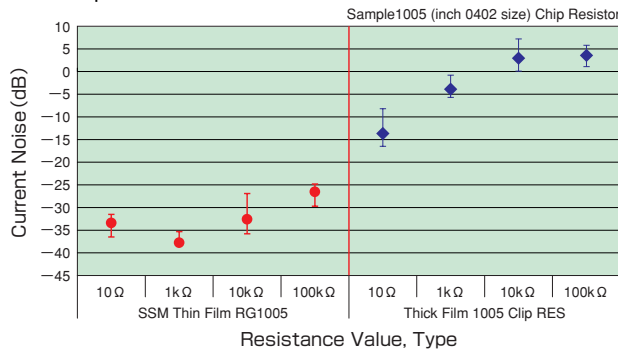

Conversion Chart of Noise Measurement

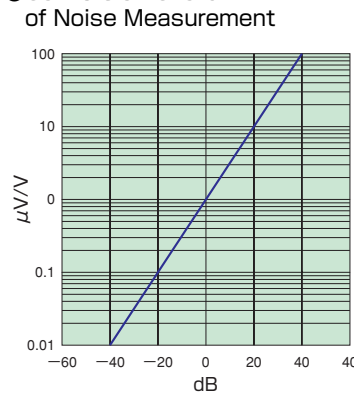

Test method: JIS C5202 Fixed Resistor Test Method, Appendix 1 "Method for Measuring Current Noise of Resistors"

High frequency Characteristics

In high frequency, electrons only move on the surface of the conductor (skin effect). Thin film resistors, being literally thin (a few hundred angstroms), will not be affected by the skin effect nor other disturbances such as resonance or stray inductance

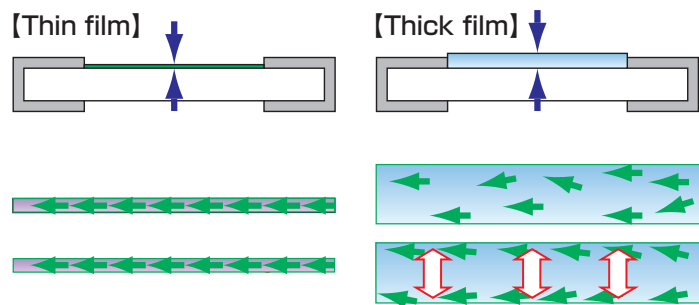

Frequency Characteristics

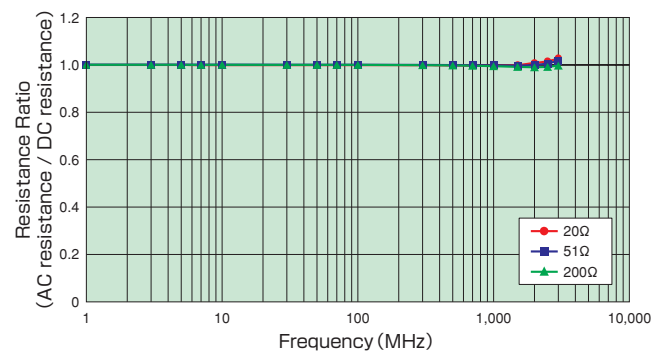
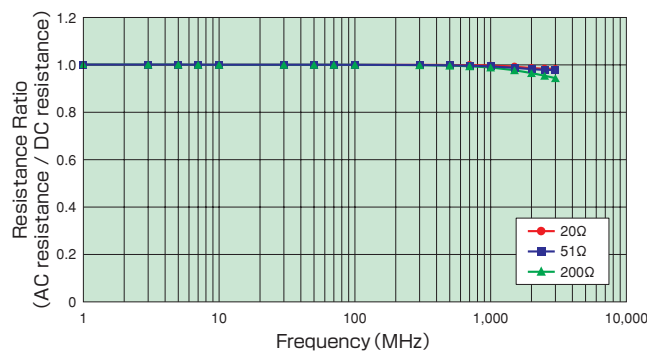

On Environment

On Environment

Thin Film products by Susumu is environmentally friendly by nature.

■ Completely lead free: Our thin film products do not contain any lead even in the areas that are not restricted by RoHS.

Typical RG/RM construction and composition

Structure	weight % of each structure						Composition of RoHS restricted materials					
	RG1005	RG1608	RG2012	RG3216	RM2012	RM3216	Heavy metals				PBB	PBBE
							Cadmium and its compounds	Lead and its compounds	Mercury and its compounds	Hexavalent chromium		
Substrate	83.2	87	87.6	89.5	87.8	92.86	<1ppm	<1ppm	<5ppm	<1ppm	not detected	not detected
Resistor	0.02	0.02	0.02	0.02	0.02	0.02	not detected	not detected	not detected	not detected	not detected	not detected
Inner electrode	0.65	0.13	0.11	0.15	0.15	0.1	not detected	not detected	not detected	not detected	not detected	not detected
Mid electrode	8.33	5.82	5.58	4.83	5.87	2.96	not detected	not detected	not detected	not detected	not detected	not detected
Outer electrode (Sn100%)	5.45	3.81	3.66	3.16	3.84	1.94	not detected	not detected	not detected	not detected	not detected	not detected
Protective coating	A	2.35	2.88	2.67	2.06	1.95	not detected	not detected	not detected	not detected	not detected	not detected
	B						<2ppm	<2ppm	<2ppm	<2ppm	<5ppm	<5ppm
	C						<5ppm	<10ppm	<1ppm	<6ppm	not detected	not detected
Marking ink	—	0.34	0.36	0.28	0.37	0.25	<2ppm	7ppm	<2ppm	<2ppm	<2ppm	not detected
Weight	0.72mg	2.07mg	4.12mg	8.26mg	4.11mg	7.96mg						

■ Products' extremely long life contributes to conserving resources.

- Thin film resistors are high precision and very reliable by nature. New RG series boasts 8 times longer life compared to our conventional thin film resistors.
- Under normal usage (normal temp. and humidity), the expected resistance drift is less than 0.1% after 116 years

Comparison to our conventional product

Product series	Type	Judgment Criteria	Years
RG series	Highly reliable thin film chip resistor	0.1% resistance drift	over 116 years
RR series	Thin film chip resistor		14 years

Test Condition: 85°C, 85%RH, 10% rated voltage bias, 90 min. on/30min. off

■ Thin film enables us to make components smaller, contributing conserving resources.

Example 2: RGH series

Power	Conventional type	RGH	area %
1/8W	1.6×0.8	1.0×0.5	39%
1/4W	3.2×1.6	2.0×1.25	48%

Comparison to our conventional product (unit: mm)

SSM Group Companies, as a whole group, strive to create environmentally friendly components.

SSM Group ISO14001 certification status

Company Name	Facilities	Certification date	Certifying body	Cert. #
Susumu Co., Ltd.	Obama Factory	2000.12.15	JQA	EM1184
	Headquarter, Sales offices			
Yokohama Denshi Seiko Co., Ltd.	Niigata Factory	2001.03.09	JQA	EM1388
Thin Film Technology Corp.	Mankato facility	2000.03.24	UL	A8561
Cyntec Co., Ltd.	Hsin-Chu (Taiwan)	2002.08.26	UL	A8561
	Suzhou (China)	2003.10.22	UKAS	140858

Recommended land pattern

RG・RGH series

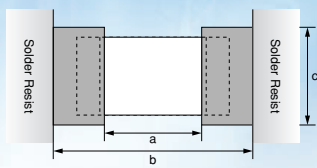

Series	Dimension:mm		
	a	b	c
RG1005, RGH1005	0.5	1.6	0.6
RG1608	1.0	3.0	1.2
RG2012, RGH2012	1.2	4.0	1.65
RG3216	2.2	5.0	2.0

RM series

RM2012

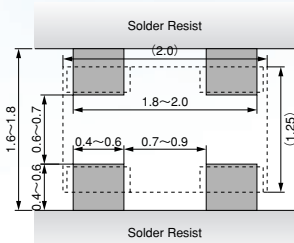

Dimension:mm

RM3216

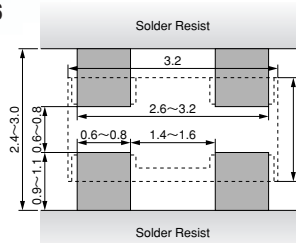

Dimension:mm

Power Derating

① Rated Power

The standard ambient temperature is 30°C. When an ambient temperature exceeds 30°C, the maximum load power is calculated by multiplying the rated power with the ratio derived from the power derating curve

② Rated voltage

The rated voltage is the corresponding voltage of DC or AC (commercially used frequency) current to

$$E = \sqrt{R \times P}$$

E : Rated voltage (V)
P : Rated power (W)
R : Rated resistance (Ω)

● Power derating curve (RG, RM, RGH series)

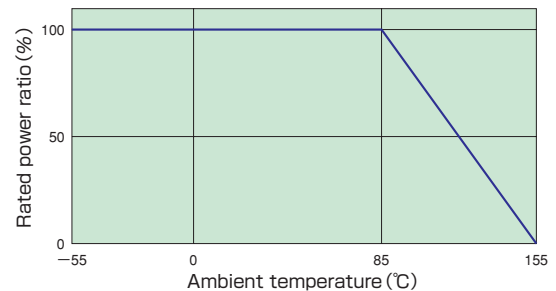

Recommended Reflow

● Recommended reflow temperature profile

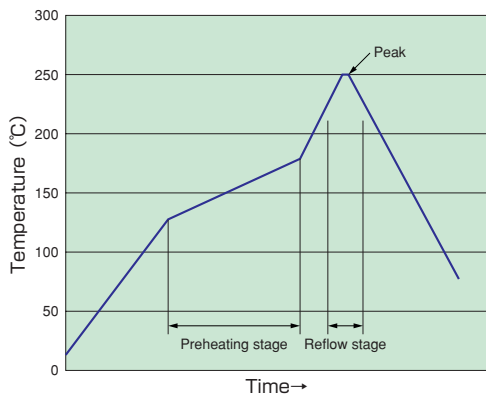

● Part's surface temperature

Pre-heat	130~180°C	60~90sec.
reflow	Over 220°C	30~90sec.
peak temperature	240~250°C	within 10sec.

● Solder composition : Sn-Ag-Cu solder

● Repetition :

up to 2 times
(Cooling between the two reflow is required.)

Tape Specification

RG series

RG1005 (2mm pitch paper tape)

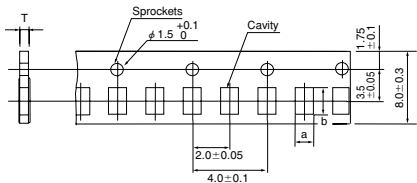

RG3216 Tape dimensions (Emboss)

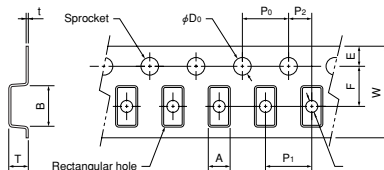

Dimension:mm	
Series	RG3216
A	2.0±0.2
B	3.6±0.2
W	8.0±0.3
F	3.5±0.05
E	1.75±0.1
P ₀	4.0±0.1
P ₁	4.0±0.1
P ₂	2.0±0.05
D ₀	1.55±0.05
D ₁	1.05±0.05
T	1.5 max
t	0.3 max

RG1608, RG2012 (4mm pitch paper tape)

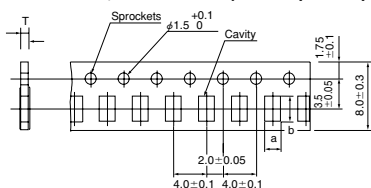

Series	Dimension:mm		
	RG1005	RG1608	RG2012
T	0.43±0.05	0.6±0.05	0.75±0.05
a	0.63±0.05	1.1±0.1	1.65±0.2
b	1.13±0.05	1.9±0.1	2.4±0.2

RM series

Emboss

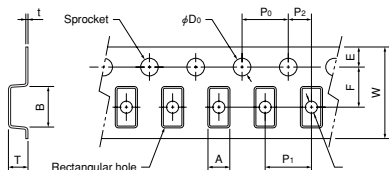

Series	Dimension:mm	
	RM2012	RM3216
A	1.6±0.2	2.0±0.2
B	2.4±0.2	3.6±0.2
W	8.0±0.3	8.0±0.3
F	3.5±0.05	3.5±0.05
E	1.75±0.1	1.75±0.1
P ₀	4.0±0.1	4.0±0.1
P ₁	4.0±0.1	4.0±0.1
P ₂	2.0±0.05	2.0±0.05
D ₀	1.55±0.05	1.55±0.05
D ₁	—	1.05±0.05
T	≤1.5	≤1.5
t	≤0.3	≤0.3

Reel Specification RG, RGH, RM series

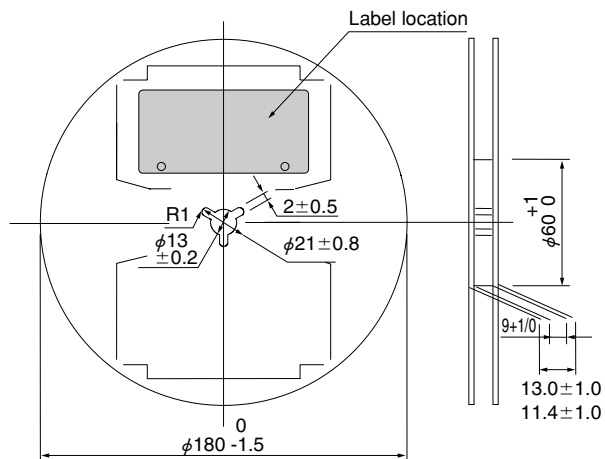

RG, RM Process

RG, RM Process

Sputtering

Electrode & Resistance Forming

● After Resistance and Electrode Pattern Forming

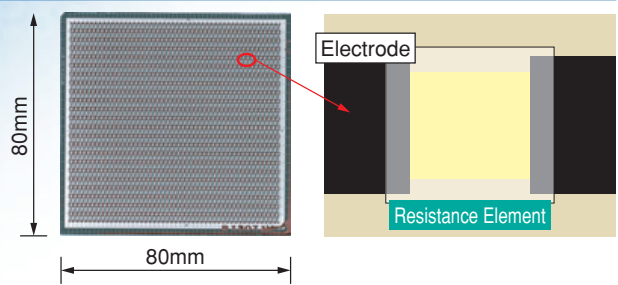

Annealing

Coating (Non-Organic)

In-Organic formation process

Trimming

YAG laser energy passes through the protective layer

● Trimming

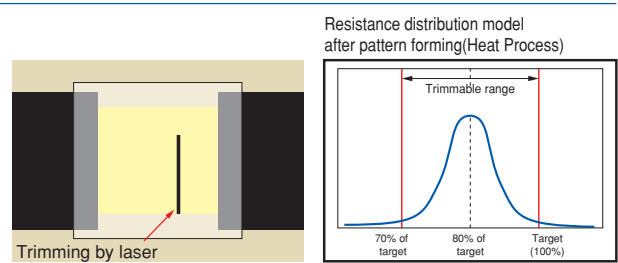

At Trimming, resistance film becomes adjusted to target value by influence of insulated film which is transformed by heat energy of laser. Resistance before trimming is designed as lower than target value(approx. 80% to 85%).

Coating

Black color coating for pick & place purpose

Marking

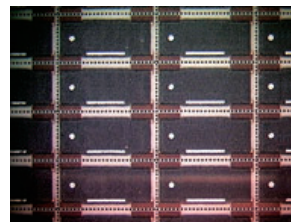

After Resin Coat and Marking

【Resin Coat】
Epoxy resin is screen-painted onto glass inorganic film.

【Marking】
Direction mark, part number etc. are screen-printed.

● Resin Coat Marking

Side Electrode Forming

Inspection

Products (Tape & Reel)

● Products (Tape & Reel)



STANDARD RESISTANCE VALUES

Please refer to the following table of the standard E-Series application for resistors.

SERIES	SIGNIFICANT FIGURES														
E-6	1.00	1.50	2.20	3.30	4.70	6.80									
E-12	1.00	1.20	1.50	1.80	2.20	2.70	3.30	3.90	4.70	5.60	6.80	8.20			
E-24	1.00	1.10	1.20	1.30	1.50	1.60	1.80	2.00	2.20	2.40	2.70	3.00	3.30	3.60	3.90
E-96	1.00	1.02	1.05	1.07	1.10	1.13	1.15	1.18	1.21	1.24	1.27	1.30	1.33	1.37	1.40
	1.43	1.47	1.50	1.54	1.58	1.62	1.65	1.69	1.74	1.78	1.82	1.87	1.91	1.96	2.00
	2.05	2.10	2.15	2.21	2.26	2.32	2.37	2.43	2.49	2.55	2.61	2.67	2.74	2.80	2.87
	2.94	3.01	3.09	3.16	3.24	3.32	3.40	3.48	3.57	3.65	3.74	3.83	3.92	4.02	4.12
	4.22	4.32	4.42	4.53	4.64	4.75	4.87	4.99	5.11	5.23	5.36	5.49	5.62	5.76	5.90
	6.04	6.19	6.34	6.49	6.65	6.81	6.98	7.15	7.32	7.50	7.68	7.87	8.06	8.25	8.45
	8.66	8.87	9.09	9.31	9.53	9.76									

Preferred value of resistance shall be composed by significant figures shown in the above table and multipliers including $\times 10\Omega$, $\times 100\Omega$, $\times 1,000\Omega$, $\times 10,000\Omega$, and $\times 100,000\Omega$.

- specifications in this catalogue are subject to change for future improvement without prior notice
- the contents of this catalogue are current as of June 2005
- The Susumu World Group companies, including Susumu Company Ltd., Thin Film Technology Corporation, Yokohama Denshi Seiko Company, Ltd., and Cyntec Company Ltd., do not recommend the use of their products in any life support applications where failure or malfunction of the product can or may cause failure of a life support device or system, or effect in any manner its safety or effectiveness. Should the customer use a product in a life support application then, in that event, the Susumu World Group companies disclaim any and all express or implied warranties as to fitness for any particular purpose or as to merchantability.

Caution for mounting the product

<Caution for mounting the product>

- (1) Please be careful not to scratch the protection coating while (pre/after) mounting. Any scratches may lead to the deterioration on durability against moisture.
- (2) When soldering by soldering iron, heating should be done on a land so that the tip of soldering iron will not touch the component itself. Also, if soldering is done at high temperature, please do soldering as short time as possible (less than 3 seconds under 350°C is preferable).
- (3) Remaining flux may lead to deterioration of durability against moisture due to corrosion and occurrence of electrolyte. Specially, if high activating flux, such as chlorine related one, is used, please check its characteristics before using it.
- (4) Adherence and remaining of ionized impurity also may lead to deterioration of durability against moisture due to corrosion and occurrence of electrolyte. Please be careful of not to touch the components with sweated bare hand pre/after mounting.
- (5) High temperature and long soldering may cause the poor soldering on electrode.
- (6) In case of placing resistors in resin after mounting, please pay special attention to the selection for it. It is recommended to check durability against heat and moisture, good shock absorption, and not-containing ionized impurity.

<Environment and conditions of usage>

- (1) Usage and conditions under special environment, it is recommended to confirm the specification and reliability of products. Below conditions are considered as special environments.
 - ① Places where products are immersed in such liquids as water, salt water, oil, acid, and an organic solvent. Or, there is possibility of splash of these liquids.
 - ② Direct sunlight, exposure at outdoor, and dusty environment.
 - ③ A place where condensation is expected.
 - ④ A place where the exposure to toxic gas (sea breeze, HCl, Cl_2 , SO_2 , H_2S , N_2H_4 , NO_x , etc.) is expected.
- (2) When using the product under high temperature and high humidity
 - ① When using the product under high temperature environment, including generation of heat under consideration, please derate the maximum load in accordance with the derating curve stated on the specification.
 - ② When conducting in high moisture environment or the state of condensation, it may lead to the increase in resistance value or break.
- (3) Dissipation, Pulse loading
Please use the product under rated power. Also please set the maximum voltage under rated voltage upon pulse loading.



SUSUMU WORLD GROUP

Copyright © 2006 by SUSUMU CO.,LTD.
 Published by Overseas Sales, 14 Umamawashi-cho,
 Kamitoba, Minami-ku, Kyoto 601-8177, Japan
 All rights reserved.
 This book, or parts there of, may not be reproduced
 in any form without permission.
 Printed in Japan.

Distributors and Contacts

Europe

Finland

MELART COMPONENTS
Masalantie 375
Fin-02430, Masala, Finland
tel: +358-9-2219-1400
fax: +358-9-2219-1444
melart.elektroniikka@nylund.fi

France

DIOTEC FRANCE
2 Rue de Denisy, Hautbout, 78660
Saint-Martin de Brethencourt, France
tel: +33-1-30-59-49-97
fax: +33-1-30-59-48-82
diotec.france@wanadoo.fr

Germany

SUSUMU DEUTSCHLAND GmbH
Koelner Strasse 10b. 5OG
D-65760, Eschborn, Germany
tel: +49-6196-4009-46
fax: +49-6196-4008-67
ssmeuro@susumu.co.jp

ENDRICH BAUELEMENTE VERTRIEBS GmbH

Hauptstrasse 56, D-72202, Nagold, Germany
tel: +49-7452-6007-28
fax: +49-7452-6007-70
endrich@endrich.com

Italy

ABACUS ECC SPA
Via Volta 54 20090, Cusago (MI), Italy
tel: +39-02-903-971
fax: +39-02-903-972-52
info@eccabacus.it

Switzerland

QUARZ AG
Wiesenstrasse 2
Monchaltorf, CH-8617, Switzerland
tel: +41-44-949-18-00
fax: +41-44-949-18-01
components@quarz.ch

United Kingdom

RHOPOINT COMPONENTS, LTD.
Hurst Green
Oxted, Surrey, RH8 9AX England
tel: +44-1-883-717-988
fax: +44-1-883-712-938
components@rhpoint.co.uk

Middle East

Israel

BORAN TECHNOLOGIES LTD.
18 Hashaham St. P.O.Box 2627, Petah Tikva 49125, Israel
tel: +972-3-9274747
fax: +972-3-9274741
www.boran.co.il
boran@boran.co.il

Asia

Japan

SUSUMU CO.,LTD.
14 Umamawashi-Cho
Kamitoba, Minami-Ku
Kyoto, 601-8177 Japan
tel: +81-75-671-7371
fax: +81-75-671-7374
www.susumu.co.jp
info@susumu.co.jp

YOKOHAMA DENSHI SEIKO CO.,LTD.

2-14-26 Shinyokohama Kohoku-Ku
Yokohama City 222-0033 Japan
tel: +81-45-470-4711
fax: +81-45-470-4712
www.yds.co.jp
info@yds.com

Taiwan

CYNTEC CO., LTD.
No. 2 R&D 2nd Road,
Science-Based Industrial Park,
Hsin-Chu,Taiwan, R.O.C.
tel: +886-35-799829
fax: +886-35-799827
www.cyntec.com
cyntec@shts.seed.net.tw

Singapore

NCH TECHNOLOGIES (S) PTE LTD.
629 Aljunied Road #03-20
Cititech Industrial Building
Singapore, 389838
tel: +65-6741-4070
fax: +65-6741-2971
kazunaga@pacific.net.sg

Korea

Chemi-Con Korea Corporation
Rm1201,Family Tower,#958-2,Yeongtong-Dong,
Yeongtong-Gu, Suwon-City,
Gyeonggi Do,Korea
tel: +82-31-202-6484
fax: +82-31-202-6485
www.chemi-conKorea.co.kr
hah@chemi-conkorea.co.kr

China

SUSUMU(SUZHOU)CO.,LTD.
NO. 288, Yun Dong Big Road,
Wujiang Economic Development Zone,
Jiang Su Province, 215200 P. R. C.
tel: +86-512-63407780
fax: +86-512-63407782
susumu_fr@163.com

North America

THIN FILM TECHNOLOGY CORP.

1980 Commerce Drive, N.Mankato, MN 56003-1702, USA
tel: +1-507-625-8445
fax: +1-507-625-3523
www.thin-film.com
sales@thin-film.com

Digi-Key Corporation

701 Brooks Ave. South Theif River Falls, MN 56701-0677
tel: +1-218-681-6674, 1-800-344-4539
fax: +1-218-681-3380
www.digikey.com

SUSUMU INTERNATIONAL (USA) INC.

460 Bergen Blvd., Suite 300-78 Palisades Park, NJ 07650, USA
tel: +1-201-328-0307
fax: +1-201-328-0308
www.susumu-usa.com
info@susumu-usa.com

Newark InOne

4801 N. Ravenswood Chicago,IL 60640-4496
tel: +1-773-784-5100,1-800-463-9275
fax: +1-888-551-4801
www.newark.com