

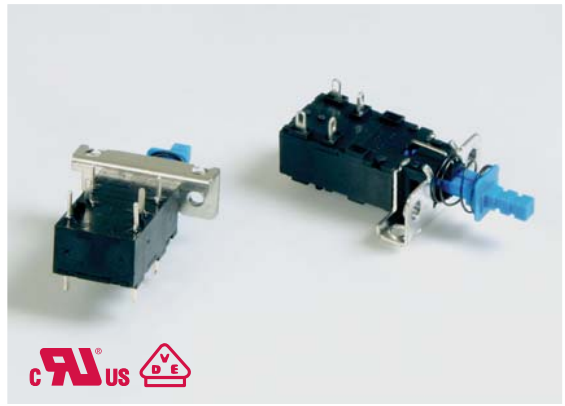

SERIES P227 SWITCHES

POWER PUSHBUTTON SWITCHES



SPECIFICATIONS

Rating:	7A @ 125 VAC - UL, CUL 4A @ 250 VAC - UL, CUL
Electrical Life:	6,000 cycles
Contact Resistance:	100mΩ max. typical; initial @ 2-4 VDC
Dielectric Strength:	> 1,500 volts 1 minute > 3,000 volts between poles
Operating Force:	550 ±150 gram force
Operating Temperature:	-20°C to +85°C

MATERIALS

Housing:	Polybutylene Terephthalate (PBT)
Actuator:	Acetal
Bracket:	Steel, tin plated
Contacts:	Silver tin oxide plated copper alloy
Terminals:	Silver plated copper alloy

FEATURES & BENEFITS

- ▶ Power pushbutton rated up to 7 amps
- ▶ Latching & momentary functions
- ▶ Panel & PC board mount options

APPLICATIONS/MARKETS

- ▶ Telecommunications
- ▶ Networking
- ▶ Computers/servers
- ▶ Performance audio
- ▶ Instrumentation
- ▶ Low power on/off designs
- ▶ External hard drives and modems

HOW TO ORDER

SERIES	MECHANICAL CONFIGURATION	CIRCUIT	BRACKET TYPE	PANEL MOUNT 'B' DIMENSION	TERMINATION	CAP	CAP COLOR
P227							See Cap Options
	EE = Latching OA = Momentary	1 = DPST 2 = DPDT	A = 2-Ø3.2 Panel Mount B = 2-M3.0 x 0.5P Threaded Panel Mount C = PC Bracket D = No Chassis	15 = 15mm 18 = 18mm 20 = 20mm X =None	A B C		

Example Ordering Number
P227-EE-1-B-20-A-TAG-BLK

Specifications subject to change without notice.

MECHANICAL CONFIGURATION & CIRCUIT OPTIONS

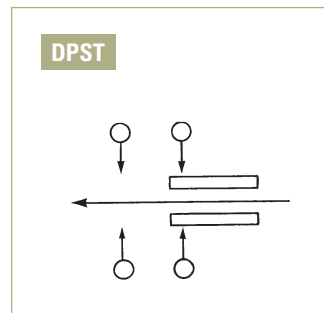
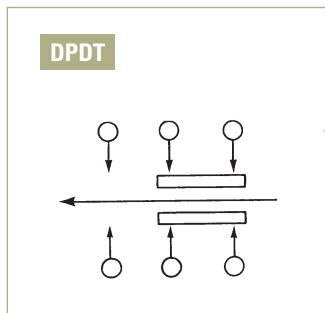

Mechanical Configuration Code	
EE	Latching
OA	Momentary

SERIES P227 SWITCHES

POWER PUSHBUTTON SWITCHES

BRACKET OPTIONS

A

2-Ø3.2 (Non-Threaded)

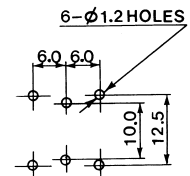
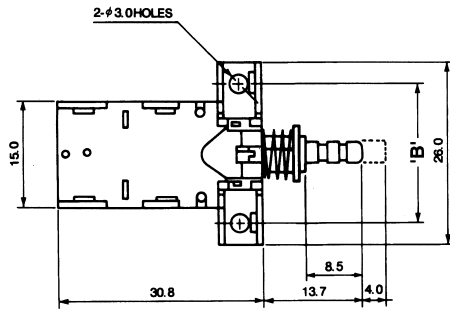
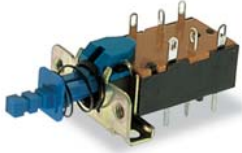

P.C. MOUNTING

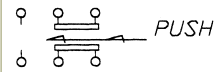

SCHEMATIC

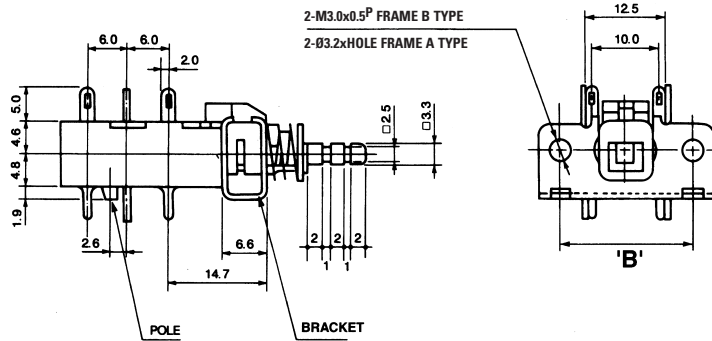

Bracket Type	'B' Dimension Availability		
	15mm	18mm	20mm
A	X	X	X
B	X	X	X

BRACKET OPTIONS

B

2-M3.0 x 0.5P (Threaded)

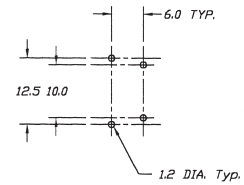
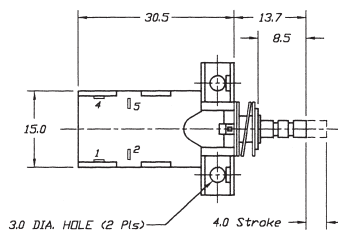

P.C. MOUNTING

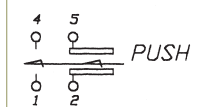

SCHEMATIC

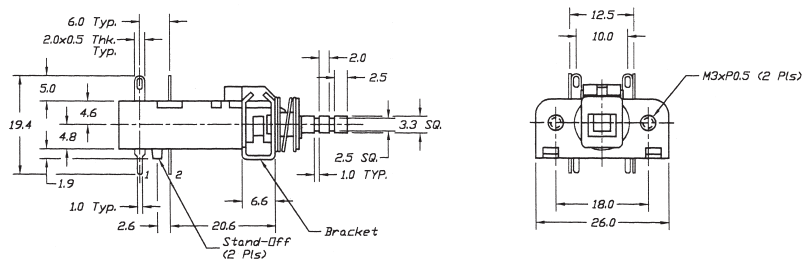

BRACKET OPTIONS

C

P.C. MOUNT

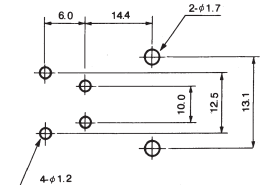
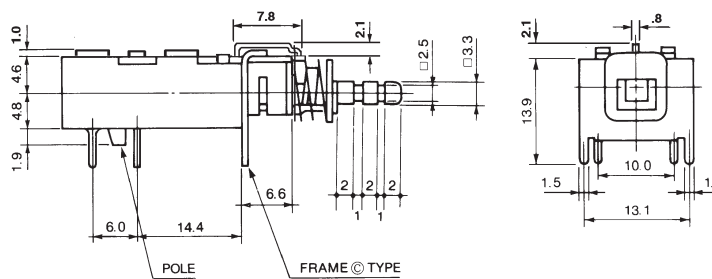

P.C. MOUNTING



TERMINATION OPTIONS

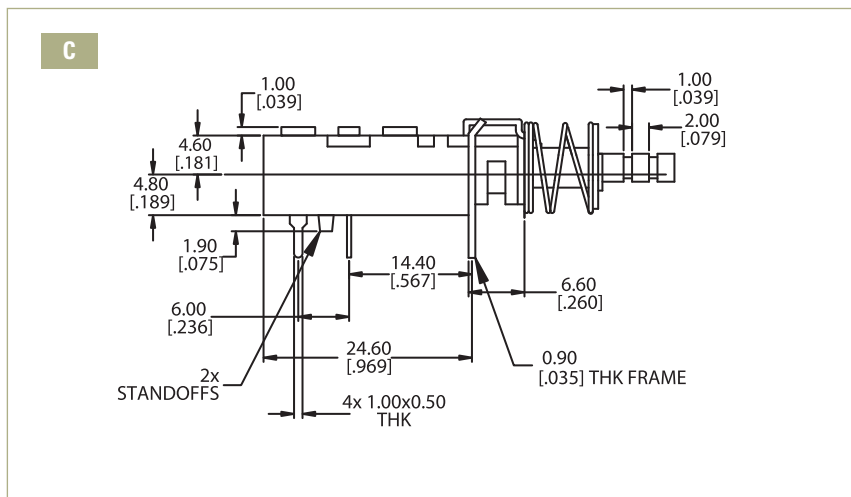
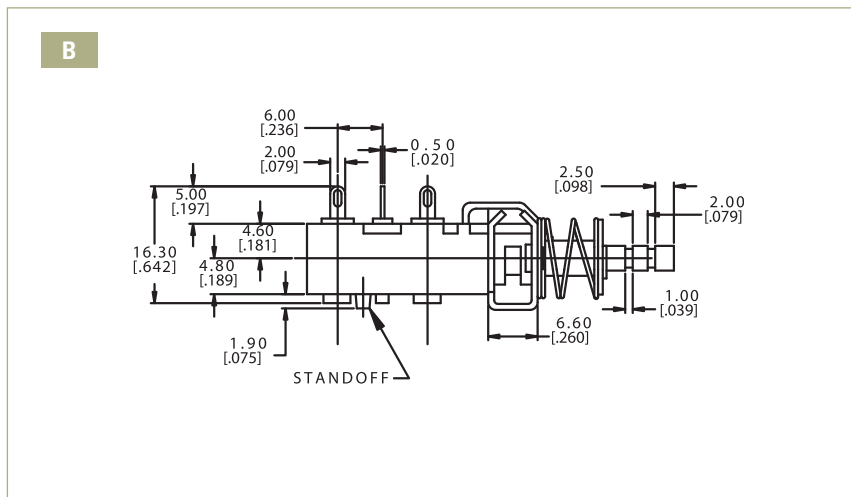
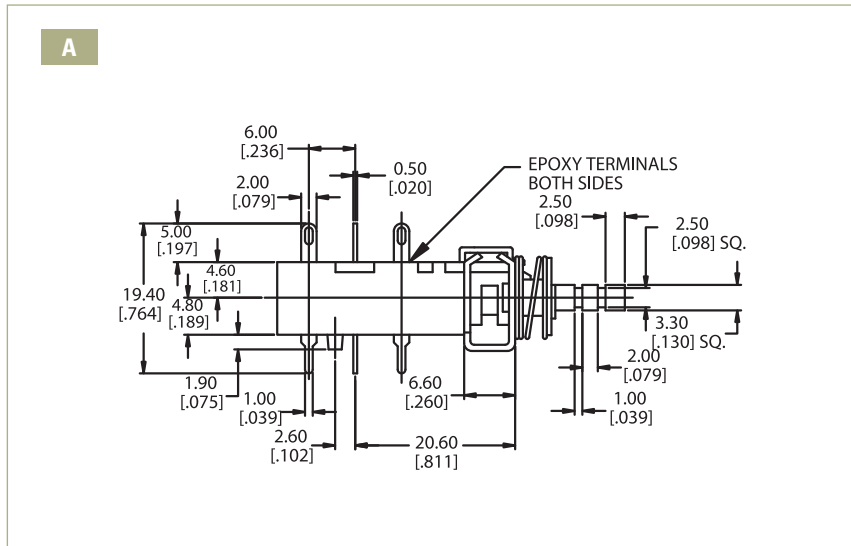

TACT SWITCHES

NAVIGATION SWITCHES

PUSHBUTTON SWITCHES

TOGGLE SWITCHES

ROCKER SWITCHES

SLIDE SWITCHES

SNAP-ACTION SWITCHES

DIP SWITCHES

KEYLOCK SWITCHES

ROTARY SWITCHES

DETECTOR SWITCHES

CAP OPTIONS