

Part No	Inductance L (nH)	f _L (MHz)	Tol ± (%)	Q min	f _Q (MHz)	SRF min (MHz)	DCR max (Ω)	Rated DC Current (mA)
0805AS-2N7X-01	2.7	250	5,10	80	1500	6000	0.08	600
0805AS-3N3X-01	3.3	250	5,10	50	1500	6000	0.08	600
0805AS-3N6X-01	3.6	250	5,10	25	1500	6000	0.18	600
0805AS-3N9X-01	3.9	250	5,10	25	1000	6000	0.20	600
0805AS-5N6X-01	5.6	250	5,10	53	1000	5500	0.11	600
0805AS-5N8X-01	5.8	250	5,10	50	1000	5500	0.11	600
0805AS-6N8X-01	6.8	250	5,10	50	1000	5500	0.11	600
0805AS-8N0X-01	8.0	250	5,10	51	1000	4700	0.12	600
0805AS-8N2X-01	8.2	250	5,10	50	1000	4700	0.12	600
0805AS-010X-01	10	250	2,5,10	43	1000	4300	0.13	600
0805AS-011X-01	11	250	5,10	65	1000	4000	0.13	600
0805AS-012X-01	12	250	2,5,10	50	500	4000	0.15	600
0805AS-015X-01	15	250	2,5,10	50	500	3400	0.17	600
0805AS-018X-01	18	250	2,5,10	53	500	3300	0.20	500
0805AS-022X-01	22	250	2,5,10	57	500	2600	0.22	500
0805AS-027X-01	27	250	2,5,10	55	500	2500	0.25	500
0805AS-033X-01	33	250	2,5,10	60	500	2050	0.27	500
0805AS-036X-01	36	250	5,10	60	500	2050	0.27	600
0805AS-039X-01	39	250	2,5,10	60	500	2000	0.29	500
0805AS-047X-01	47	200	2,5,10	65	500	1650	0.31	500
0805AS-048X-01	48	200	2,5,10	65	500	1580	0.30	500
0805AS-056X-01	56	200	2,5,10	64	500	1550	0.34	500
0805AS-068X-01	68	200	2,5,10	65	500	1450	0.38	400
0805AS-075X-01	75	200	2,5,10	55	500	1300	0.42	400
0805AS-082X-01	82	150	2,5,10	67	500	1300	0.42	400
0805AS-R10X-01	100	150	2,5,10	65	500	1200	0.46	400
0805AS-R12X-01	120	150	2,5,10	52	250	1100	0.51	400
0805AS-R13X-01	130	100	2,5,10	53	250	920	0.56	400
0805AS-R15X-01	150	100	2,5,10	60	250	920	0.56	400
0805AS-R18X-01	180	100	2,5,10	50	250	870	0.64	400
0805AS-R20X-01	200	100	2,5,10	54	250	850	0.70	400
0805AS-R22X-01	220	100	2,5,10	59	250	850	0.70	400
0805AS-R24X-01	240	100	2,5,10	52	250	850	0.80	400
0805AS-R25X-01	250	100	2,5,10	52	250	850	0.80	400
0805AS-R27X-01	270	100	2,5,10	40	100	820	1.5	280
0805AS-R29X-01	290	100	2,5,10	40	100	795	1.8	260
0805AS-R30X-01	300	100	2,5,10	40	100	795	1.8	260
0805AS-R31X-01	310	100	2,5,10	40	100	795	1.8	260
0805AS-R32X-01	320	100	2,5,10	40	100	790	1.8	260
0805AS-R33X-01	330	100	2,5,10	40	100	790	1.8	260
0805AS-R34X-01	340	100	2,5,10	40	100	790	1.8	260
0805AS-R35X-01	350	100	2,5,10	40	100	750	2.0	200
0805AS-R39X-01	390	100	2,5,10	42	100	750	2.0	200
0805AS-R45X-01	450	100	2,5,10	40	100	720	2.5	200
0805AS-R47X-01	470	100	2,5,10	40	100	720	2.5	170
0805AS-R51X-01	510	100	2,5,10	40	100	650	3.5	170
0805AS-R56X-01	560	100	2,5,10	40	100	650	3.5	170
0805AS-R68X-01	680	50	2,5,10	37	75	600	4.0	170
0805AS-R75X-01	750	25	5,10	23	50	215	2.4	180
0805AS-R80X-01	800	25	5,10	23	50	215	2.4	180
0805AS-R82X-01	820	25	5,10	23	50	215	2.4	180
0805AS-R91X-01	910	25	5,10	23	50	215	2.4	180
0805AS-1R0X-01	1000	25	5,10	23	50	215	2.4	180
0805AS-1R2X-01	1200	7.9	5,10	15	50	150	2.8	200
0850AS-1R5X-01	1500	7.9	5,10	15	7.9	150	3.0	200
0805AS-1R8X-01	1800	7.9	5,10	15	7.9	80	3.0	210
0805AS-2R0X-01	2000	7.9	5,10	15	7.9	80	3.5	170
0805AS-2R2X-01	2200	7.9	5,10	15	7.9	80	3.8	150
0503AS-2R4X-01	2400	7.9	5,10	15	7.9	80	3.8	120
0805AS-2R7X-01	2700	7.9	5,10	15	7.9	80	5.0	120
0805AS-3R0X-01	3000	7.9	5,10	15	7.9	80	4.8	120
0805AS-3R3X-01	3300	7.9	5,10	15	7.9	80	5.1	120
0805AS-3R6X-01	3600	7.9	5,10	15	7.9	80	5.0	100
0805AS-3R9X-01	3900	7.9	5,10	15	7.9	80	7.1	100
0805AS-4R3X-01	4300	7.9	5,10	15	7.9	80	7.2	100
0805AS-4R7X-01	4700	7.9	5,10	15	7.9	50	8.0	100
0805AS-5R6X-01	5600	7.9	5,10	15	7.9	50	9.5	90
0805AS-100X-01	10000	7.9	5,10	15	7.9	35	16.0	60

0805 AS

Engineer's Kit : EK-0805AS-X

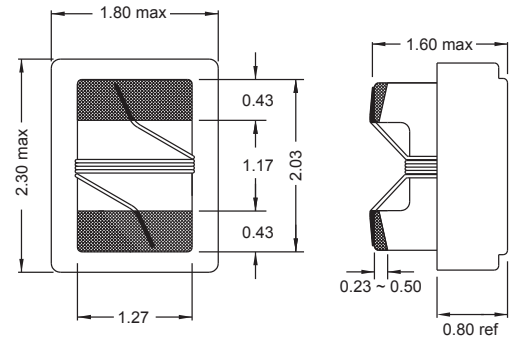
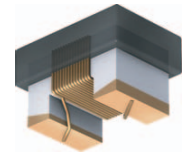

All dimensions in mm

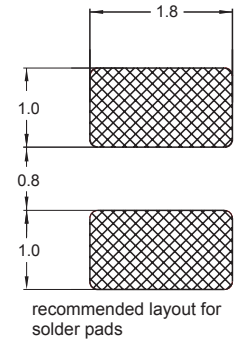

Chip Inductors (wire wound - open)

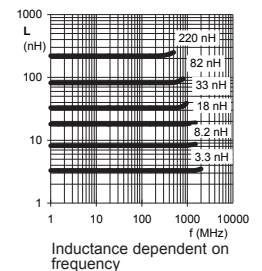
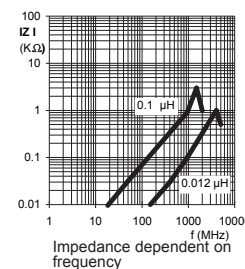
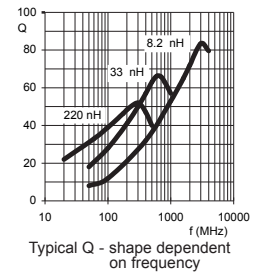
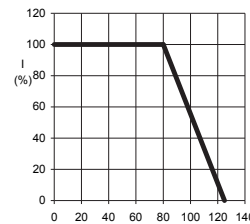

Material : Ceramic
SPQ : Reel 2500 [-01]

Remark: For not listed inductance values please check availability with us.