



General data

RAFIX 22QR control component range

- For a mounting hole diameter of 22.3 mm to IEC 60947
- 250V/10A max.
- Water-jet proof IP65
- 2 collar shapes
- The lamps of the pushbuttons can also be replaced from the front
- The contact blocks (silver or gold contacts) snap onto the actuators with a coupling
- Screw terminals, cage clamp terminals or RJ12 connector
- 3 NC + 3 NO max.

The specified data apply only if actuators/signal indicators are combined with contact blocks and lamp sockets within the same product range.

Content

| | |
|--|----------------|
| RAFIX 22 QR control component assemblies | 2 - 98 |
| RAFIX 22 QR assembly: Pushbutton, round, illuminated, flush lens, metallized front ring and silver contact block | 2 - 99 |
| RAFIX 22 QR assembly: Emergency stop pushbutton and silver contact block | 2 - 99 |
| RAFIX 22 QR assembly: Signal indicator and lamp socket | 2 - 100 |
| RAFIX 22 QR pushbutton | 2 - 102 |
| RAFIX 22 QR pushbutton, flush lens, round collar | 2 - 103 |
| RAFIX 22 QR pushbutton, protruding lens, round collar | 2 - 104 |
| RAFIX 22 QR pushbutton, protruding front ring, round collar | 2 - 105 |
| RAFIX 22 QR pushbutton, flush lens, square collar | 2 - 106 |
| RAFIX 22 QR pushbutton, protruding lens, square collar | 2 - 107 |
| RAFIX 22 QR pushbutton, protruding front ring, square collar | 2 - 108 |
| RAFIX 22 QR selector switch | 2 - 110 |
| RAFIX 22 QR selector switch, round collar, short handle | 2 - 111 |
| RAFIX 22 QR selector switch, round collar, long handle | 2 - 112 |
| RAFIX 22 QR selector switch, square collar, short handle | 2 - 113 |
| RAFIX 22 QR selector switch, square collar, long handle | 2 - 114 |
| RAFIX 22 QR keylock switch | 2 - 116 |
| RAFIX 22 QR keylock switch, round collar | 2 - 117 |
| RAFIX 22 QR keylock switch, square collar | 2 - 118 |

| | |
|--|----------------|
| RAFIX 22 QR mushroom-headed pushbutton | 2 - 120 |
| RAFIX 22 QR mushroom-headed pushbutton 40 mm, round collar | 2 - 121 |
| RAFIX 22 QR mushroom-headed pushbutton 40 mm, illuminated, round collar | 2 - 121 |
| RAFIX 22 QR mushroom-headed pushbutton 60 mm, round collar | 2 - 122 |
| RAFIX 22 QR mushroom-headed pushbutton 40 mm, square collar | 2 - 122 |
| RAFIX 22 QR mushroom-headed pushbutton 40 mm, illuminated, square collar | 2 - 123 |
| RAFIX 22 QR mushroom-headed pushbutton 60 mm, square collar | 2 - 123 |
| RAFIX 22 QR emergency stop pushbutton, dupe-proof to EN 418 | 2 - 124 |
| RAFIX 22 QR emergency stop pushbutton, dupe-proof to EN 418 | 2 - 125 |
| RAFIX 22 QR emergency stop pushbutton, dupe-proof to EN 418, with indication to EN 60947-1 | 2 - 125 |
| RAFIX 22 QR emergency stop pushbutton, dupe-proof to EN 418, with keylock | 2 - 126 |
| RAFIX 22 QR emergency stop pushbutton, dupe-proof to EN 418, illuminated | 2 - 126 |
| RAFIX 22 QR twin pushbutton | 2 - 128 |
| RAFIX 22 QR twin pushbutton, oval collar | 2 - 129 |
| RAFIX 22 QR twin pushbutton, rectangular collar | 2 - 130 |
| RAFIX 22 QR potentiometer drive | 2 - 132 |
| RAFIX 22 QR potentiometer drive, round collar | 2 - 133 |
| RAFIX 22 QR potentiometer drive, square collar | 2 - 133 |
| RAFIX 22 QR buzzer | 2 - 134 |
| RAFIX 22 QR buzzer, round collar | 2 - 135 |
| RAFIX 22 QR buzzer, square collar | 2 - 135 |
| RAFIX 22 QR signal indicator | 2 - 136 |
| RAFIX 22 QR signal indicator, round collar | 2 - 137 |
| RAFIX 22 QR signal indicator, square collar | 2 - 137 |
| RAFIX 22 QR contact blocks with silver contacts, screw terminals and cage clamp terminals | 2 - 138 |
| RAFIX 22 QR contact block with silver contacts | 2 - 139 |
| RAFIX 22 QR contact block assembly, with coupling, without lamp socket, silver contacts | 2 - 140 |
| RAFIX 22 QR contact block assembly, with coupling and lamp socket, silver contacts | 2 - 141 |
| RAFIX 22 QR contact blocks with gold contacts, screw terminals and cage clamp terminals | 2 - 142 |
| RAFIX 22 QR contact block with gold contacts | 2 - 143 |
| RAFIX 22 QR contact block assembly, with coupling, without lamp socket, gold contacts | 2 - 144 |
| RAFIX 22 QR contact block assembly, with coupling and lamp socket, gold contacts | 2 - 145 |
| Contact block with coupling, gold contacts, RJ 12 connector, integrated LED | 2 - 146 |
| Contact block with coupling, gold contacts, RJ 12 connector, integrated LED | 2 - 147 |
| RAFIX 22 QR lamp sockets BA 9s (MBC/MCC), screw terminals and cage clamp terminals | 2 - 148 |
| RAFIX 22 QR lamp socket, without coupling | 2 - 149 |
| RAFIX 22 QR lamp socket assembly, with coupling | 2 - 150 |
| RAFIX 22 QR lamp sockets with integrated LED, screw terminals | 2 - 152 |
| RAFIX 22 QR lamp socket with integrated red LED, without coupling | 2 - 153 |
| RAFIX 22 QR special accessories | 2 - 154 |
| Housings for flush pushbuttons | 2 - 154 |
| Lenses for flush pushbuttons | 2 - 155 |
| Front ring | 2 - 156 |
| RAFIX 22 QR plastic front ring with protective cap | 2 - 156 |
| Label holder | 2 - 157 |
| Legend labe to clip label holder 5.07.620.xxx | 2 - 157 |
| Coupling | 2 - 158 |
| Blanking cap | 2 - 158 |
| Ring nut | 2 - 159 |
| Lamp tester | 2 - 159 |
| Protective cover, suitable for pushbuttons with flush lens | 2 - 159 |
| Marking tag | 2 - 160 |
| Insulating housing IP65 for RAFIX 22 QR | 2 - 160 |
| Emergency stop label plate | 2 - 161 |



Contact blocks marked with different colours for ease of identification in stock and when connecting.

- NC contacts: red
- NO contacts: green
- NC/NO contacts: red/green
- Lamp socket: black
- Silver contacts:
basic housing colour is black
- Gold contacts:
basic housing colour is grey
- The terminals associated with a contact pair are colour coded on the connection side and marked with the respective contact numbers.

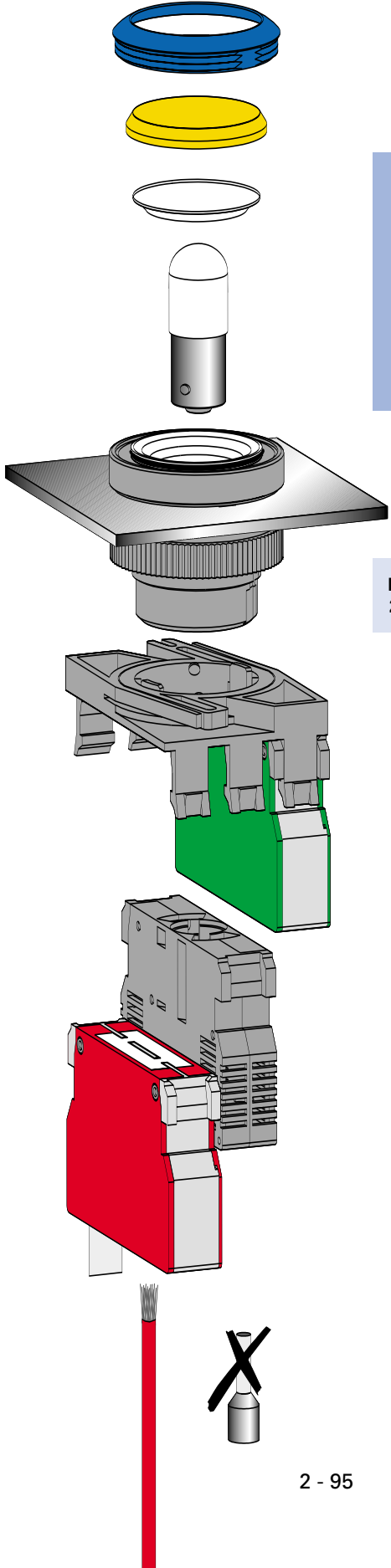

2

RAFIX 22 QR

The lamps of pushbuttons and signal lamps can be replaced from the front. This method saves time and increases safety since it eliminates the need for accessing the machine/control station interior and handling live cables for lamp replacement. After unscrewing the front ring, the lens can be removed and the lamp replaced.



The components feature a removable locating lug. If installed without locating lug, the ring nut with claw can be used. Accurate alignment of the actuator can be achieved behind the front panel. The cast-on collar seal can not get lost nor be twisted during installation and allows single-person assembly: the actuator is held in the mounting hole by the cast-on seal and can then be fixed by screwing from the rear.



First, snap the lamp socket and contact blocks into the coupling. Then snap the assembly on to the actuator. To release it, the bayonet must be pressed (prevents inadvertent releasing at the same time).

Terminals

Screw terminals, cage clamp or RJ 12

The RAFIX 22 QR contact blocks are available in three different connection styles as required for your application:

Screw terminals

The terminals are open and the captive screws are mounted in the terminal recess.

Cage clamp terminals

Simply insert a screwdriver to open the terminal, insert the cable and remove the screwdriver to close the terminal.

RJ 12-terminal

Just plug in the cable with a RJ 12 connector. Details see page 25.

Assembly

Screw terminals

Cage clamp terminals

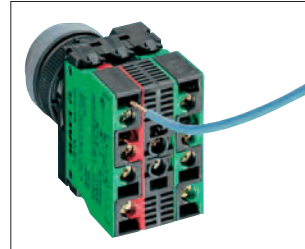

Insert the wire.

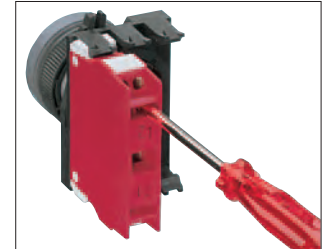

Open the terminal.

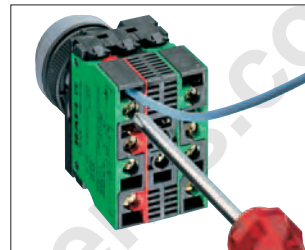

Tighten the screw.

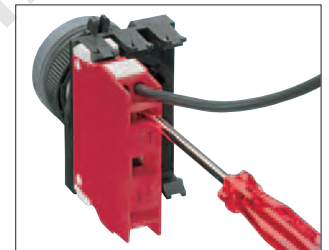

Insert the wire.

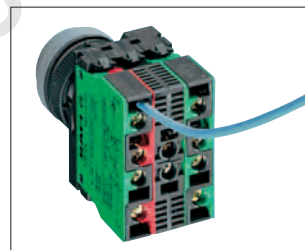

Done.

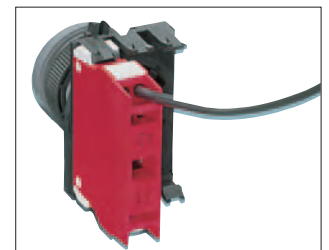

Remove the screwdriver.

2

Your advantage:

This offers your savings in three ways:

- Drastically reduced assembly time thanks to wire insertion from the rear, i.e. no more bending and lateral insertion of the wires required.
- You save material: No wire end sleeves are required.
- You save the time previously required for mounting the wire end sleeves.



Sealed for life against humidity and dirt

The special seal reliably prevents moisture, oil and dust from penetrating to the contact block. In contrast to other sealing types which move up and down the shaft, this special seal is firmly seated on the housing (degree of protection IP 65 to DIN).

Versatility of design for customized panels

The RAFIX 22 QR system does not only have a particularly low profile and is also available in many different versions. Your design options for your customized panels are nearly unlimited thanks to the interchangeable front rings and lenses. In this way you can achieve an attractive design while ensuring safe operation of your equipment at the same time.

RAFIX 22 QR components are available either with a round or with a square collar.



RAFIX 22 QR

onlinecomponents.com
THE ONLINE DISTRIBUTOR OF ELECTRONIC COMPONENTS

The RAFIX 22 QR control component range meets all the technical requirements and current standards for control units. The system is of modular design. Actuators, contact blocks and lamp sockets can be

combined freely. This means that you may implement modifications of design or configuration even at the last minute. An additional positive effect is the reduction of stockholding costs.



Sequence of assembly/disassembly at screw terminals and cage clamp terminals

- Fix the actuator in the front panel with the ring nut.
- Snap the individual elements (a maximum three contact blocks or two contact blocks together with a lamp socket) in the coupling. You can install them on any assembling axis.
- Insert the lamp or LED into the lamp socket.

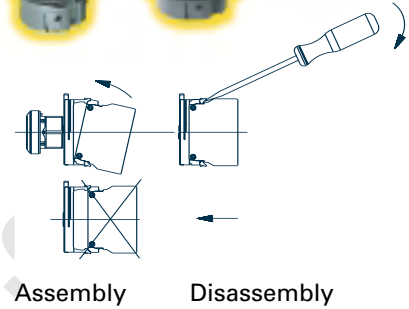

Approvals

● = approved, ○ = pending

| Part no. | BG zert. | VDE 0660 | 10/15 | ULc | GL |
|--------------|----------|----------|-------|-----|----|
| 1.20 124.--- | ○ | ○ | ● | ● | ○ |
| 1.20 125.--- | ○ | ○ | ● | ● | ○ |
| 1.30 243.--- | ○ | | | ● | |
| 1.71 213.--- | | ○ | ● | ● | ○ |
| 1.71 214.--- | | ○ | ● | ● | ○ |

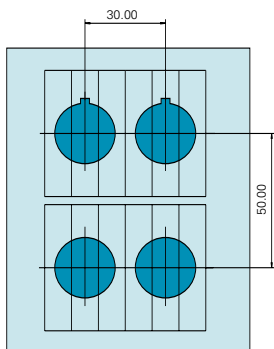

Panel cut-out according to IEC 60947-5-1

All actuators are provided with a locating lug which may be removed using a screwdriver for installation into mounting holes if required.

With a grid spacing of 30 mm horizontally and 50 mm vertically, the collars of the square actuators touch each other. We recommend to use the same grid spacing also for the round collar shapes (IEC 947).

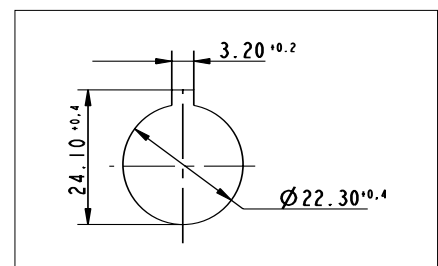

Dimensioned drawing

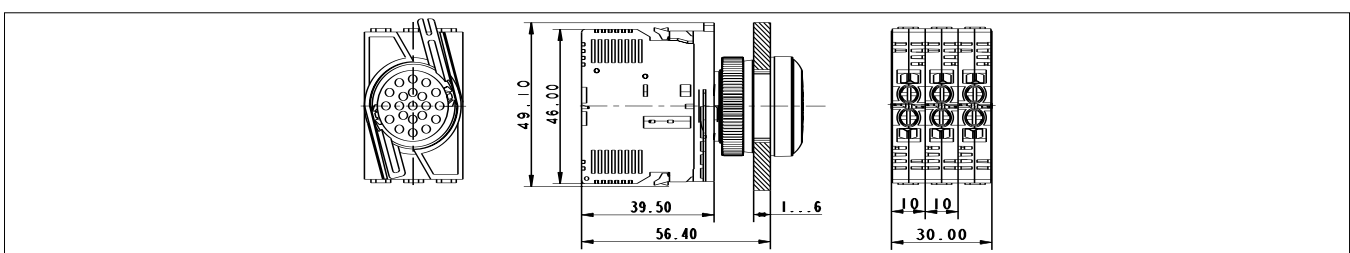

RAFIX 22 QR control component assemblies



Pict.: 1 NO, lamp socket, red lens

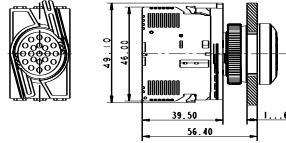

with contact block

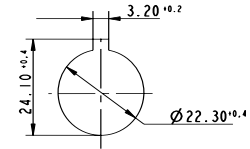

panel cut-out acc. to IEC 60947-5-1

2

Technical data

General information

| | |
|----------------------|-----------------|
| Form of lens | see order block |
| Colour of lens | see order block |
| Colour of front ring | see order block |
| Form of collar | round |

Dimensions

| | |
|--------------------|-----------------|
| Key grid | 50 x 30 mm |
| Diameter of collar | 29.8 mm |
| Overall height | see order block |
| Mounting depth | 56.4 mm |
| Mounting hole | 22.3 mm |

Mechanical design

| | |
|---------------------|-----------------|
| Mounting | ring nut |
| Contact function | see order block |
| Illuminability | see order block |
| Contact arrangement | see order block |

Mechanical characteristics

| | |
|----------------------|-------------------------------------|
| Operating force max. | approx. 5 N for 1 switching element |
| Robustness min. | 100 N |

Electrical characteristics

| | |
|------------------|----|
| Protection class | II |
|------------------|----|

Other specifications

| | |
|--------------------------------------|---------------------------------------|
| Degree of protection from front side | IP65 |
| Storage temperature min. | -40 °C |
| Storage temperature max. | +80 °C |
| Resistance to constant environment | according to IEC 600 68-2-3 and 2-30 |
| Resistance at variable environment | according to IEC 600 68-2-14 and 2-33 |
| Ambient temp. operating min. | -25 °C |
| Ambient temp. operating max. | +70 °C |
| Approvals | ENEC 10/15, ULC |

Accessories RAFIX 22 QR control component assemblies

| Description | Photo | Order no. | Page |
|--|-------|--------------------------|---------|
| Filament lamp, BA 9s base (MBC/MCC), 24 - 30 V | | 1.90.060.133/0000 | 5 - 8 |
| Neon lamp BA 9s (MBC/MCC), 220 V AC (red) | | 1.90.560.102/0000 | 5 - 9 |
| LED BA 9s (MBC/MCC) superbright, white, 24 V | | 1.90.690.345/0000 | 5 - 20 |
| Fixing spanner for ring nut and front ring | | 5.05.800.062/0000 | 5 - 25 |
| Label holder, round collar, with adhesive tape and release liner on back | | 5.07.620.010/0000 | 2 - 157 |

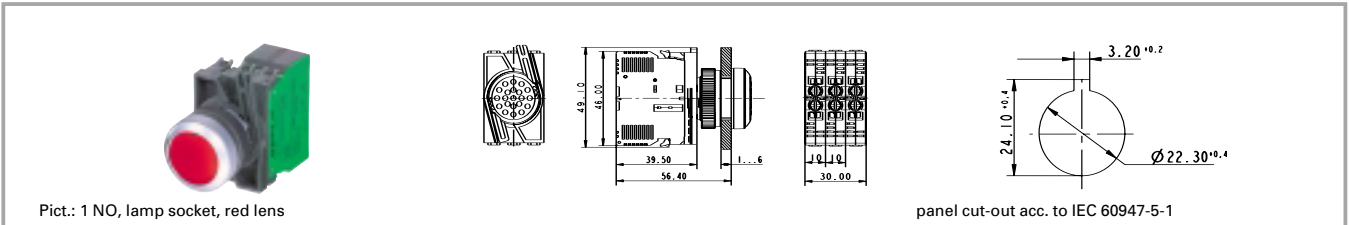
RAFIX 22 QR assembly: Pushbutton, round, illuminated, flush lens, metallized front ring and silver contact block

| Contact arrangement | Contact function | Colour of lens | Order no. complete | Order no. single parts | |
|---------------------|------------------|------------------------|--------------------|------------------------|--------------------------|
| | | | | Contact block | Actuator |
| 1 NO | momentary | transparent colourless | 9.20.124.001/1000 | 1.20.124.022/0000 | 1.30.240.021/1000 |
| 1 NO | momentary | transparent red | 9.20.124.001/1300 | 1.20.124.022/0000 | 1.30.240.021/1300 |
| 1 NO | momentary | transparent yellow | 9.20.124.001/1400 | 1.20.124.022/0000 | 1.30.240.021/1400 |
| 1 NO | momentary | transparent green | 9.20.124.001/1500 | 1.20.124.022/0000 | 1.30.240.021/1500 |
| 1 NO | momentary | transparent blue | 9.20.124.001/1600 | 1.20.124.022/0000 | 1.30.240.021/1600 |

Technical data see page 2 - 98

Accessories:

- Filament lamp, BA 9s base (MBC/MCC), 12 - 15 V: **1.90.060.132/0000**
- Filament lamp, BA 9s base (MBC/MCC), 24 - 30 V: **1.90.060.133/0000**
- Filament lamp, BA 9s base (MBC/MCC), 110 - 130 V: **1.90.060.137/0000**
- LED BA 9s (MBC/MCC) superbright, red, 24 V: **1.90.690.341/0000**
- LED BA 9s (MBC/MCC) superbright, green, 24 V: **1.90.690.342/0000**
- LED BA 9s (MBC/MCC) superbright, yellow, 24 V: **1.90.690.343/0000**
- LED BA 9s (MBC/MCC) superbright, blue, 24 V: **1.90.690.344/0000**
- LED BA 9s (MBC/MCC) superbright, white, 24 V: **1.90.690.345/0000**
- Legend insert without legend: **5.70.800.000/2000**

2
RAFIX 22 QR
RAFIX 22 QR assembly: Emergency stop Twist to Reset pushbutton and silver contact block

| Contact arrangement | Contact function | Colour of lens | Order no. complete | Order no. single parts | |
|---------------------|------------------|----------------|--------------------|--------------------------|--------------------------|
| | | | | Contact block | Actuator |
| 1 NC | latching | opaque red | 9.20.124.030/0300 | 1.20.124.001/0000 | 1.30.243.501/0300 |
| 1 NC + 1 NO | latching | opaque red | 9.20.124.031/0300 | 1.20.124.017/0000 | 1.30.243.501/0300 |

Technical data see page 2 - 98

Accessories:

- Emergency stop label, yellow, round 60 mm, PVC adhesive, with legend "NOT-AUS": 5.76.204.101/0400
- Emergency stop label, yellow, round 60 mm, rigid PVC, with legend "EMERGENCY-STOP/ARRET D'URGENCE": 5.76.207.002/0400

RAFIX 22 QR assembly: Signal indicator and lamp socket



Pict.: Signal indicator, yellow lens

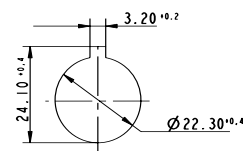
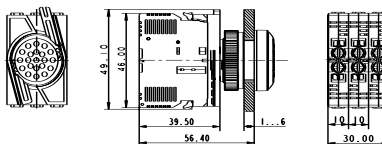

panel cut-out acc. to IEC 60947-5-1

| Contact arrangement | Contact function | Colour of lens | Order no. complete | Order no. single parts | |
|---------------------|------------------|------------------------|--------------------|--------------------------|--------------------------|
| | | | | Contact block | Actuator |
| | | transparent colourless | 9.71.213.001/1000 | 1.71.213.001/0000 | 1.74.505.501/1000 |
| | | transparent red | 9.71.213.001/1300 | 1.71.213.001/0000 | 1.74.505.501/1300 |
| | | transparent yellow | 9.71.213.001/1400 | 1.71.213.001/0000 | 1.74.505.501/1400 |
| | | transparent green | 9.71.213.001/1500 | 1.71.213.001/0000 | 1.74.505.501/1500 |
| | | transparent blue | 9.71.213.001/1600 | 1.71.213.001/0000 | 1.74.505.501/1600 |

Technical data see page 2 - 98

Accessories:

- Filament lamp, BA 9s base (MBC/MCC), 12 - 15 V: **1.90.060.132/0000**
- Filament lamp, BA 9s base (MBC/MCC), 24 - 30 V: **1.90.060.133/0000**
- Filament lamp, BA 9s base (MBC/MCC), 110 - 130 V: **1.90.060.137/0000**
- LED BA 9s (MBC/MCC) superbright, red, 24 V: **1.90.690.341/0000**
- LED BA 9s (MBC/MCC) superbright, green, 24 V: **1.90.690.342/0000**
- LED BA 9s (MBC/MCC) superbright, yellow, 24 V: **1.90.690.343/0000**
- LED BA 9s (MBC/MCC) superbright, blue, 24 V: **1.90.690.344/0000**
- LED BA 9s (MBC/MCC) superbright, white, 24 V: **1.90.690.345/0000**
- Legend insert without legend: 5.70.803.000/2000

RAFIX 22 QR pushbutton

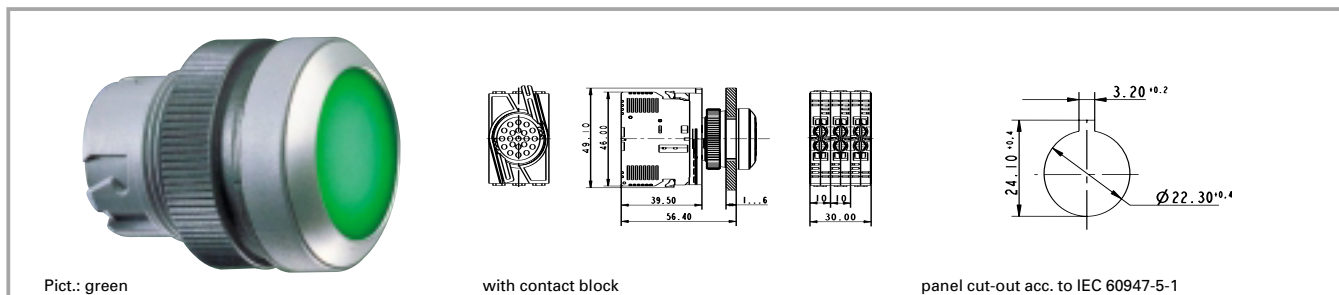

2

Technical data

General information

| | |
|----------------------|-----------------|
| Form of lens | see order block |
| Colour of lens | see order block |
| Colour of front ring | see order block |
| Form of collar | see order block |

Dimensions

| | |
|---|-----------------|
| Length of collar | see order block |
| Width of collar | see order block |
| Overall height | see order block |
| Mounting depth with contact block without cable | 56.4 mm |
| Mounting hole | 22.3 mm |
| Key grid | 50 x 30 mm |
| Diameter of collar | see order block |

Mechanical design

| | |
|------------------|-----------------|
| Mounting | ring nut |
| Contact function | see order block |
| Illuminability | see order block |

Mechanical characteristics

| | |
|----------------------|-------------------------------------|
| Operating travel | 4 mm |
| Operating force max. | approx. 5 N for 1 switching element |
| Robustness min. | 100 N |

Other specifications

| | |
|--------------------------------------|--|
| Operating life (operations) | 1 million momentary/ 0.5 million latching |
| Degree of protection from front side | IP65 |
| Ambient temp. operating min. | -25 °C |
| Ambient temp. operating max. | +70 °C |
| Storage temperature min. | -40 °C |
| Storage temperature max. | +80 °C |
| Resistance to constant environment | according to IEC 600 68-2-3 and 2-30 |
| Resistance at variable environment | according to IEC 600 68-2-14 and 2-33 |

Accessories RAFIX 22 QR pushbutton

| Description | Photo | Order no. | Page |
|--|-------|--------------------------|---------|
| RAFIX 22 QR contact block with silver contacts, with coupling, without lamp socket, screw terminals, 1 NO | | 1.20.124.002/0000 | 2 - 140 |
| RAFIX 22 QR contact block with silver contacts, with coupling and lamp socket, screw terminals, 1 NC + 1 NO | | 1.20.124.027/0000 | 2 - 141 |
| RAFIX 22 QR contact block with gold contacts, with coupling and lamp socket, screw terminals, 1 NO | | 1.20.124.122/0000 | 2 - 145 |
| RAFIX 22 QR contact block with silver contacts, with coupling and lamp socket, cage clamp terminals, 1 NO, 1 | | 1.20.125.025/0000 | 2 - 141 |
| Filament lamp, BA 9s base (MBC/MCC), 24 - 30 V | | 1.90.060.133/0000 | 5 - 8 |
| LED BA 9s (MBC/MCC) superbright, white, 24 V | | 1.90.690.345/0000 | 5 - 20 |

Accessories RAFIX 22 QR pushbutton

| Description | Photo | Order no. | Page |
|--|-------|--------------------------|---------|
| Fixing spanner for ring nut and front ring | | 5.05.800.062/0000 | 5 - 25 |
| Label holder, round collar, with adhesive tape and release liner on back | | 5.07.620.010/0000 | 2 - 157 |

For other contact blocks, refer to the chapter „Contact blocks“; for additional accessories, refer to „RAFIX 22 QR special accessories“.

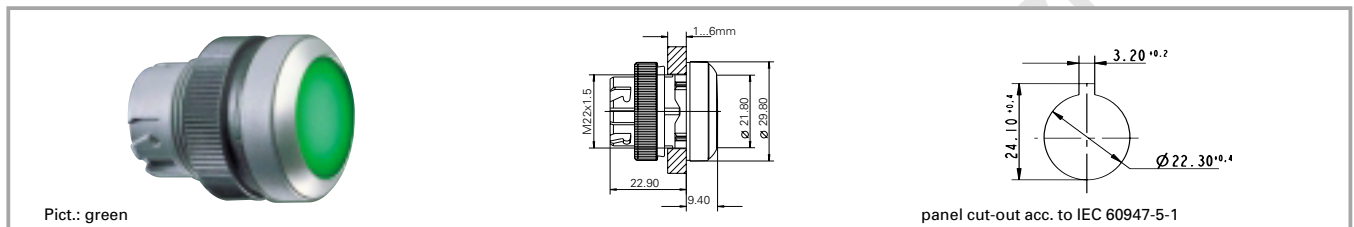
RAFIX 22 QR pushbutton, flush lens, round collar

| Illuminability | Colour of lens | Order no. momentary | | Order no. latching | |
|----------------|--------------------|---------------------|--------------------------|--------------------|--------------------------|
| | | Plastic front ring | Metallized front ring | Plastic front ring | Metallized front ring |
| yes | transparent white | 1.30.240.001/10xx | 1.30.240.021/1000 | 1.30.240.011/10xx | 1.30.240.031/1000 |
| yes | transparent red | 1.30.240.001/13xx | 1.30.240.021/1300 | 1.30.240.011/13xx | 1.30.240.031/1300 |
| yes | transparent yellow | 1.30.240.001/14xx | 1.30.240.021/1400 | 1.30.240.011/14xx | 1.30.240.031/1400 |
| yes | transparent green | 1.30.240.001/15xx | 1.30.240.021/1500 | 1.30.240.011/15xx | 1.30.240.031/1500 |
| yes | transparent blue | 1.30.240.001/16xx | 1.30.240.021/1600 | 1.30.240.011/16xx | 1.30.240.031/1600 |
| no | opaque black | 1.30.240.101/01xx | 1.30.240.121/0100 | 1.30.240.111/01xx | 1.30.240.131/0100 |
| no | opaque white | 1.30.240.101/02xx | 1.30.240.121/0200 | 1.30.240.111/02xx | 1.30.240.131/0200 |
| no | opaque red | 1.30.240.101/03xx | 1.30.240.121/0300 | 1.30.240.111/03xx | 1.30.240.131/0300 |
| no | opaque yellow | 1.30.240.101/04xx | 1.30.240.121/0400 | 1.30.240.111/04xx | 1.30.240.131/0400 |
| no | opaque green | 1.30.240.101/05xx | 1.30.240.121/0500 | 1.30.240.111/05xx | 1.30.240.131/0500 |
| no | opaque blue | 1.30.240.101/06xx | 1.30.240.121/0600 | 1.30.240.111/06xx | 1.30.240.131/0600 |
| no | opaque slate-grey | 1.30.240.101/07xx | 1.30.240.121/0700 | 1.30.240.111/07xx | 1.30.240.131/0700 |

Technical data see page 2 - 102

Accessories:

Front ring, plastic with protective cap, slate grey: 5.05.004.914/0700

Protective cover, auto-closing: 5.05.511.194/0000

Protective cover, latching: 5.05.511.195/0000

Legend insert without legend: 5.70.800.000/2000

xx = Front ring colour: black = 01, slate grey = 07, silver grey = 08

Pushbuttons with plastic front ring and white lens are also available with the following front ring colours: red = 03, yellow = 04, green = 05, blue = 06. Other colour combinations on request.

Order numbers **1.30.240.001/—08**, **1.30.240.011/—08** and **1.30.240.101/—08** (with silver grey plastic front ring) are **stock items**.

RAFIX 22 QR pushbutton, protruding lens, round collar

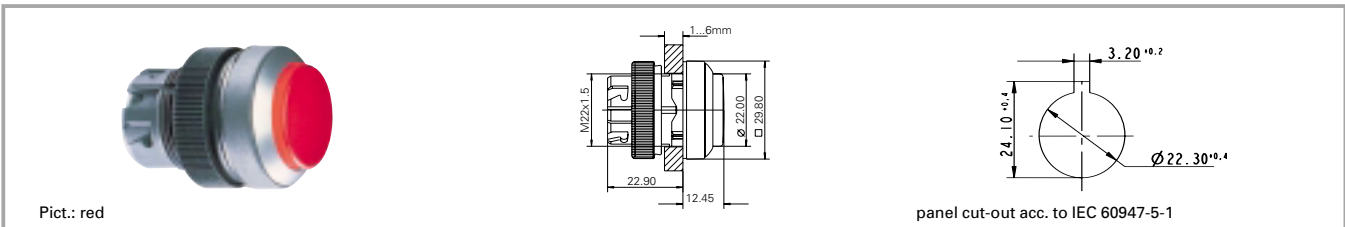

Pict.: red

panel cut-out acc. to IEC 60947-5-1

| Illuminability | Colour of lens | Order no. momentary | | Order no. latching | |
|----------------|--------------------|---------------------|--------------------------|--------------------|--------------------------|
| | | Plastic front ring | Metallized front ring | Plastic front ring | Metallized front ring |
| yes | transparent white | 1.30.240.201/10xx | 1.30.240.221/1000 | 1.30.240.211/10xx | 1.30.240.231/1000 |
| yes | transparent red | 1.30.240.201/13xx | 1.30.240.221/1300 | 1.30.240.211/13xx | 1.30.240.231/1300 |
| yes | transparent yellow | 1.30.240.201/14xx | 1.30.240.221/1400 | 1.30.240.211/14xx | 1.30.240.231/1400 |
| yes | transparent green | 1.30.240.201/15xx | 1.30.240.221/1500 | 1.30.240.211/15xx | 1.30.240.231/1500 |
| yes | transparent blue | 1.30.240.201/16xx | 1.30.240.221/1600 | 1.30.240.211/16xx | 1.30.240.231/1600 |
| no | opaque black | 1.30.240.301/01xx | 1.30.240.321/0100 | 1.30.240.311/01xx | 1.30.240.331/0100 |
| no | opaque white | 1.30.240.301/02xx | 1.30.240.321/0200 | 1.30.240.311/02xx | 1.30.240.331/0200 |
| no | opaque red | 1.30.240.301/03xx | 1.30.240.321/0300 | 1.30.240.311/03xx | 1.30.240.331/0300 |
| no | opaque yellow | 1.30.240.301/04xx | 1.30.240.321/0400 | 1.30.240.311/04xx | 1.30.240.331/0400 |
| no | opaque green | 1.30.240.301/05xx | 1.30.240.321/0500 | 1.30.240.311/05xx | 1.30.240.331/0500 |
| no | opaque blue | 1.30.240.301/06xx | 1.30.240.321/0600 | 1.30.240.311/06xx | 1.30.240.331/0600 |
| no | opaque slate-grey | 1.30.240.301/07xx | 1.30.240.321/0700 | 1.30.240.311/07xx | 1.30.240.331/0700 |

Technical data see page 2 - 102

Accessories:

Legend insert without legend: **5.70.802.000/2000**

xx = Front ring colour: black = 01, slate grey = 07, silver grey = 08

Pushbuttons with plastic front ring and white lens are also available with the following front ring colours: red = 03, yellow = 04, green = 05, blue = 06. Other colour combinations on request.

Order numbers **1.30.240.201/—08** and **1.30.240.211/—08** (with silver grey plastic front ring) are **stock items**.

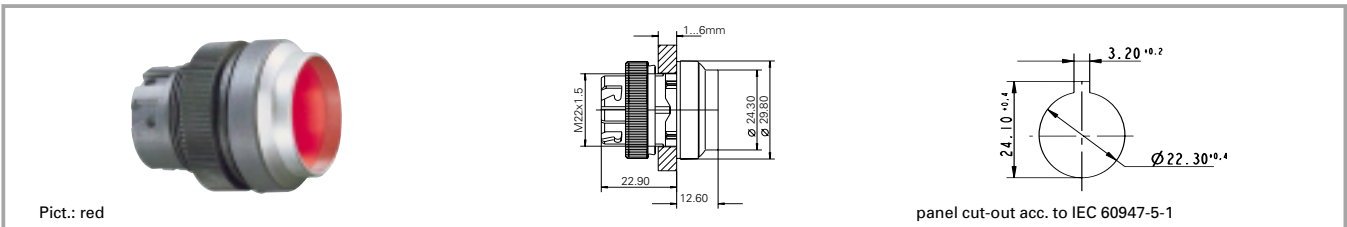
RAFIX 22 QR pushbutton, protruding front ring, round collar

| Illuminability | Colour of lens | Order no. momentary | | Order no. latching | |
|----------------|--------------------|---------------------|-----------------------|--------------------|-----------------------|
| | | Plastic front ring | Metallized front ring | Plastic front ring | Metallized front ring |
| yes | transparent white | 1.30.240.401/10xx | 1.30.240.421/1000 | | |
| yes | transparent red | 1.30.240.401/13xx | 1.30.240.421/1300 | | |
| yes | transparent yellow | 1.30.240.401/14xx | 1.30.240.421/1400 | | |
| yes | transparent green | 1.30.240.401/15xx | 1.30.240.421/1500 | | |
| yes | transparent blue | 1.30.240.401/16xx | 1.30.240.421/1600 | | |
| no | opaque black | 1.30.240.501/01xx | 1.30.240.521/0100 | | |
| no | opaque white | 1.30.240.501/02xx | 1.30.240.521/0200 | | |
| no | opaque red | 1.30.240.501/03xx | 1.30.240.521/0300 | | |
| no | opaque yellow | 1.30.240.501/04xx | 1.30.240.521/0400 | | |
| no | opaque green | 1.30.240.501/05xx | 1.30.240.521/0500 | | |
| no | opaque blue | 1.30.240.501/06xx | 1.30.240.521/0600 | | |
| no | opaque slate-grey | 1.30.240.501/07xx | 1.30.240.521/0700 | | |

Technical data see page 2 - 102

Accessories:

Legend insert without legend: 5.70.800.000/2000

xx = Front ring colour: black = 01, slate grey = 07, silver grey = 08

The protruding collar offers protection against inadvertent operation and thereby fulfils the safety requirements of various machinery manufacturers, particularly from the printing industry.

RAFIX 22 QR pushbutton, flush lens, square collar

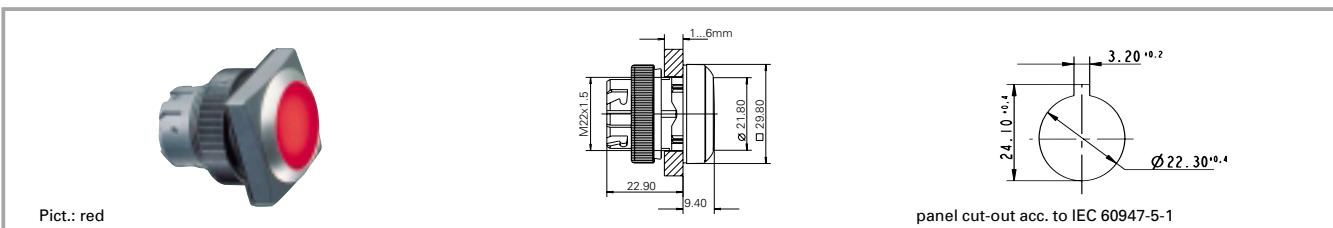

Pict.: red

panel cut-out acc. to IEC 60947-5-1

| Illuminability | Colour of lens | Order no. momentary | | Order no. latching | |
|----------------|--------------------|---------------------|--------------------------|--------------------|--------------------------|
| | | Plastic front ring | Metallized front ring | Plastic front ring | Metallized front ring |
| yes | transparent white | 1.30.240.051/10xx | 1.30.240.071/1000 | 1.30.240.061/10xx | 1.30.240.081/1000 |
| yes | transparent red | 1.30.240.051/13xx | 1.30.240.071/1300 | 1.30.240.061/13xx | 1.30.240.081/1300 |
| yes | transparent yellow | 1.30.240.051/14xx | 1.30.240.071/1400 | 1.30.240.061/14xx | 1.30.240.081/1400 |
| yes | transparent green | 1.30.240.051/15xx | 1.30.240.071/1500 | 1.30.240.061/15xx | 1.30.240.081/1500 |
| yes | transparent blue | 1.30.240.051/16xx | 1.30.240.071/1600 | 1.30.240.061/16xx | 1.30.240.081/1600 |
| no | opaque black | 1.30.240.151/01xx | 1.30.240.171/0100 | 1.30.240.161/01xx | 1.30.240.181/0100 |
| no | opaque white | 1.30.240.151/02xx | 1.30.240.171/0200 | 1.30.240.161/02xx | 1.30.240.181/0200 |
| no | opaque red | 1.30.240.151/03xx | 1.30.240.171/0300 | 1.30.240.161/03xx | 1.30.240.181/0300 |
| no | opaque yellow | 1.30.240.151/04xx | 1.30.240.171/0400 | 1.30.240.161/04xx | 1.30.240.181/0400 |
| no | opaque green | 1.30.240.151/05xx | 1.30.240.171/0500 | 1.30.240.161/05xx | 1.30.240.181/0500 |
| no | opaque blue | 1.30.240.151/06xx | 1.30.240.171/0600 | 1.30.240.161/06xx | 1.30.240.181/0600 |
| no | opaque slate-grey | 1.30.240.151/07xx | 1.30.240.171/0700 | 1.30.240.161/07xx | 1.30.240.181/0700 |

Technical data see page 2 - 102

Accessories:

Front ring, plastic with protective cap, slate grey: 5.05.004.914/0700

Legend insert without legend: 5.70.800.000/2000

xx = Front ring colour: black = 01, slate grey = 07, silver grey = 08

Pushbuttons with plastic front ring and white lens are also available with the following front ring colours: red = 03, yellow = 04, green = 05, blue = 06. Other colour combinations on request.

Order numbers **1.30.240.051/—08**, **1.30.240.061/—08** and **1.30.240.151/—08** (with silver grey plastic front ring) are **stock items**.

RAFIX 22 QR pushbutton, protruding lens, square collar

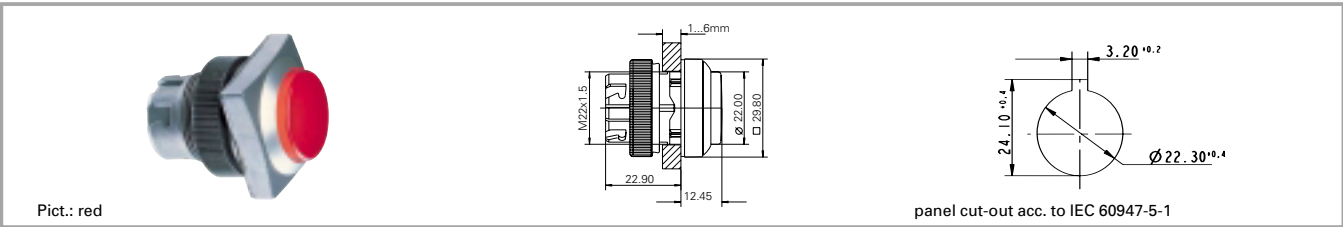

| Illuminability | Colour of lens | Order no. momentary | | Order no. latching | |
|----------------|--------------------|---------------------|--------------------------|--------------------|--------------------------|
| | | Plastic front ring | Metallized front ring | Plastic front ring | Metallized front ring |
| yes | transparent white | 1.30.240.251/10xx | 1.30.240.271/1000 | 1.30.240.261/10xx | 1.30.240.281/1000 |
| yes | transparent red | 1.30.240.251/13xx | 1.30.240.271/1300 | 1.30.240.261/13xx | 1.30.240.281/1300 |
| yes | transparent yellow | 1.30.240.251/14xx | 1.30.240.271/1400 | 1.30.240.261/14xx | 1.30.240.281/1400 |
| yes | transparent green | 1.30.240.251/15xx | 1.30.240.271/1500 | 1.30.240.261/15xx | 1.30.240.281/1500 |
| yes | transparent blue | 1.30.240.251/16xx | 1.30.240.271/1600 | 1.30.240.261/16xx | 1.30.240.281/1600 |
| no | opaque black | 1.30.240.351/01xx | 1.30.240.371/0100 | 1.30.240.361/01xx | 1.30.240.381/0100 |
| no | opaque white | 1.30.240.351/02xx | 1.30.240.371/0200 | 1.30.240.361/02xx | 1.30.240.381/0200 |
| no | opaque red | 1.30.240.351/03xx | 1.30.240.371/0300 | 1.30.240.361/03xx | 1.30.240.381/0300 |
| no | opaque yellow | 1.30.240.351/04xx | 1.30.240.371/0400 | 1.30.240.361/04xx | 1.30.240.381/0400 |
| no | opaque green | 1.30.240.351/05xx | 1.30.240.371/0500 | 1.30.240.361/05xx | 1.30.240.381/0500 |
| no | opaque blue | 1.30.240.351/06xx | 1.30.240.371/0600 | 1.30.240.361/06xx | 1.30.240.381/0600 |
| no | opaque slate-grey | 1.30.240.351/07xx | 1.30.240.371/0700 | 1.30.240.361/07xx | 1.30.240.381/0700 |

Technical data see page 2 - 102

Accessories:

Legend insert without legend: **5.70.802.000/2000**

xx = Front ring colour: black = 01, slate grey = 07, silver grey = 08

Pushbuttons with plastic front ring and white lens are also available with the following front ring colours: red = 03, yellow = 04, green = 05, blue = 06. Other colour combinations on request.

Order numbers **1.30.240.251/—08** and **1.30.240.261/—08** (with silver grey plastic front ring) are **stock items**.

RAFIX 22 QR pushbutton, protruding front ring, square collar

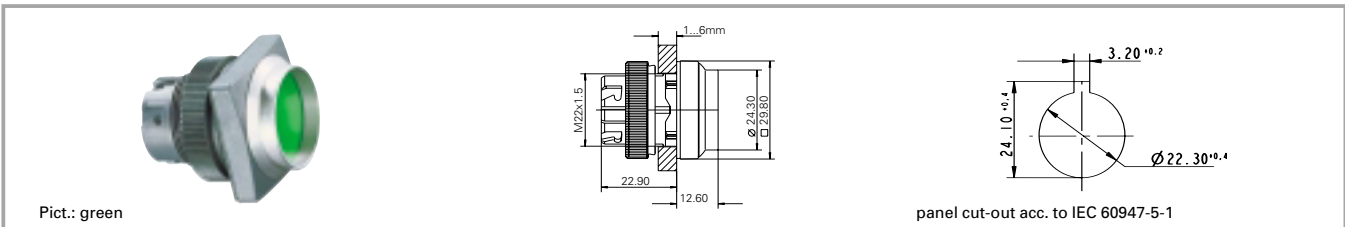

2

RAFIX
22 QR

| Illuminability | Colour of lens | Order no. momentary | | Order no. latching | |
|----------------|--------------------|---------------------|-----------------------|--------------------|-----------------------|
| | | Plastic front ring | Metallized front ring | Plastic front ring | Metallized front ring |
| yes | transparent white | 1.30.240.451/10xx | 1.30.240.471/1000 | | |
| yes | transparent red | 1.30.240.451/13xx | 1.30.240.471/1300 | | |
| yes | transparent yellow | 1.30.240.451/14xx | 1.30.240.471/1400 | | |
| yes | transparent green | 1.30.240.451/15xx | 1.30.240.471/1500 | | |
| yes | transparent blue | 1.30.240.451/16xx | 1.30.240.471/1600 | | |
| no | opaque black | 1.30.240.551/01xx | 1.30.240.571/0100 | | |
| no | opaque white | 1.30.240.551/02xx | 1.30.240.571/0200 | | |
| no | opaque red | 1.30.240.551/03xx | 1.30.240.571/0300 | | |
| no | opaque yellow | 1.30.240.551/04xx | 1.30.240.571/0400 | | |
| no | opaque green | 1.30.240.551/05xx | 1.30.240.571/0500 | | |
| no | opaque blue | 1.30.240.551/06xx | 1.30.240.571/0600 | | |
| no | opaque slate-grey | 1.30.240.551/07xx | 1.30.240.571/0700 | | |

Technical data see page 2 - 102

Accessories:

Legend insert without legend: 5.70.800.000/2000

xx = Front ring colour: black = 01, slate grey = 07, silver grey = 08

The protruding collar offers protection against inadvertent operation and thereby fulfils the safety requirements of various machinery manufacturers, particularly in the industry.

RAFIX 22 QR selector switch



2

General data

The illuminated selector switches are provided with translucent handle markings. These are opaque on the non-illuminated versions.

Technical data

General information

| | |
|----------------------|-----------------|
| Form of handle | see order block |
| Colour of lens | white |
| Colour of front ring | see order block |
| Form of collar | see order block |

Dimensions

| | |
|---|-----------------|
| Length of collar | see order block |
| Width of collar | see order block |
| Overall height | 22.2 mm |
| Mounting depth with contact block without cable | 56.4 mm |
| Mounting hole | 22.3 mm |
| Key grid | 50 x 30 mm |
| Diameter of collar | see order block |

Mechanical design

| | |
|------------------|-----------------|
| Mounting | ring nut |
| Contact function | see order block |
| Illuminability | see order block |
| Rotating angle | see order block |

Mechanical characteristics

| | |
|----------------------|-------------------------------------|
| Operating force max. | approx. 5 N for 1 switching element |
| Torque max. | 2 Nm |

Electrical characteristics

| | |
|------------------|----|
| Protection class | II |
|------------------|----|

Other specifications

| | |
|--------------------------------------|---------------------------------------|
| Operating life | 0.5 million |
| Degree of protection from front side | IP65 |
| Ambient temp. operating min. | -27 °C |
| Ambient temp. operating max. | +70 °C |
| Storage temperature min. | -40 °C |
| Storage temperature max. | +80 °C |
| Resistance to constant environment | according to IEC 600 68-2-3 and 2-30 |
| Resistance at variable environment | according to IEC 600 68-2-14 and 2-33 |

Accessories RAFIX 22 QR selector switch

| Description | Photo | Order no. | Page |
|--|-------|--------------------------|---------|
| RAFIX 22 QR contact block with silver contacts, with coupling, without lamp socket, screw terminals, 1 NC + 1 | | 1.20.124.017/0000 | 2 - 140 |
| RAFIX 22 QR contact block with silver contacts, with coupling and lamp socket, screw terminals, 1 NC + 1 NO | | 1.20.124.027/0000 | 2 - 141 |
| RAFIX 22 QR contact block with gold contacts, with coupling and lamp socket, screw terminals, 1 NC + 1 NO, 1 NC + 1 NO | | 1.20.124.128/0000 | 2 - 145 |
| Contact block with coupling, gold contacts, RJ 12 connector, 1 NC + 1 NO, white LED | | 1.20.128.013/0000 | 2 - 147 |

Accessories RAFIX 22 QR selector switch

| Description | Photo | Order no. | Page |
|--|-------|-------------------|---------|
| Label holder, round collar, with adhesive tape and release liner on back | | 5.07.620.010/0000 | 2 - 157 |

For other contact blocks, refer to the chapter „Contact blocks“; for additional accessories, refer to „RAFIX 22 QR special accessories“.

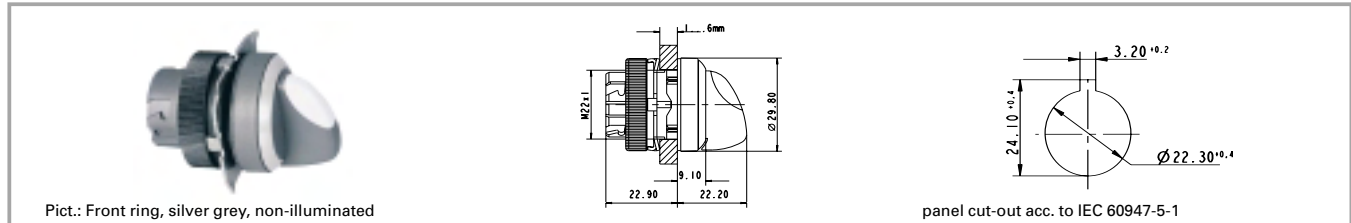
RAFIX 22 QR selector switch, round collar, short handle

| Illuminability | Contact function | Rotating angle | Drehwinkel | Order no. | |
|----------------|--|---------------------|------------|--------------------|--------------------------|
| | | | | Plastic front ring | Metal front ring |
| yes | momentary | 1 x 40° | | 1.30.242.001/22xx | 1.30.242.002/2200 |
| yes | momentary | 2 x 40° | | 1.30.242.026/22xx | 1.30.242.027/2200 |
| yes | latching 1 x 90° and momentary 1 x 40° | 1 x 90° and 1 x 40° | | 1.30.242.426/22xx | 1.30.242.427/2200 |
| yes | latching | 1 x 90°, form L | | 1.30.242.101/22xx | 1.30.242.102/2200 |
| yes | latching | 1 x 90°, form V | | 1.30.242.201/22xx | 1.30.242.202/2200 |
| yes | latching | 2 x 60° | | 1.30.242.301/22xx | 1.30.242.302/2200 |
| yes | latching | 2 x 90° | | 1.30.242.126/22xx | 1.30.242.127/2200 |
| no | momentary | 1 x 40° | | 1.30.242.501/02xx | 1.30.242.502/0200 |
| no | momentary | 2 x 40° | | 1.30.242.526/02xx | 1.30.242.527/0200 |
| no | latching 1 x 90° and momentary 1 x 40° | 1 x 90° and 1 x 40° | | 1.30.242.926/02xx | 1.30.242.927/0200 |
| no | latching | 1 x 90°, form L | | 1.30.242.601/02xx | 1.30.242.602/0200 |
| no | latching | 1 x 90°, form V | | 1.30.242.701/02xx | 1.30.242.702/0200 |
| no | latching | 2 x 60° | | 1.30.242.801/02xx | 1.30.242.802/0200 |
| no | latching | 2 x 90° | | 1.30.242.626/02xx | 1.30.242.627/0200 |

Technical data see page 2 - 110

xx = Front ring colour: black = 01, slate grey = 07, silver grey = 08; other colours on request.

Included: Ring nut with claw.

On keylock switches with 3 switching positions (e.g. 2 x 90 degrees), either the left-hand or right-hand contact block is activated, depending on the sense of rotation. A third contact block arranged in the centre would be actuated with either sense of rotation.

The following selector switches with silver grey plastic front ring are stock items:

Illuminated: 1.30.252.001/2208, 1.30.252.026/2208, 1.30.252.101/2208, 1.30.252.201/2208, 1.30.252.301/2208

Non-illuminated: 1.30.252.501/0208, 1.30.252.526/0208, 1.30.252.601/0208, 1.30.252.701/0208, 1.30.252.801/0208

RAFIX 22 QR selector switch, round collar, long handle



Pict.: Front ring, metallized, illuminated

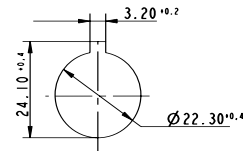
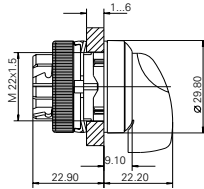

panel cut-out acc. to IEC 60947-5-1

| Illuminability | Contact function | Rotating angle | Drehwinkel | Order no. | |
|----------------|--|---------------------|------------|--------------------|-------------------|
| | | | | Plastic front ring | Metal front ring |
| yes | momentary | 1 x 40° | | 1.30.242.011/22xx | 1.30.242.012/2200 |
| yes | momentary | 2 x 40° | | 1.30.242.036/22xx | 1.30.242.037/2200 |
| yes | latching 1 x 90° and momentary 1 x 40° | 1 x 90° and 1 x 40° | | 1.30.242.436/22xx | 1.30.242.437/2200 |
| yes | latching | 1 x 90°, form L | | 1.30.242.111/22xx | 1.30.242.112/2200 |
| yes | latching | 1 x 90°, form V | | 1.30.242.211/22xx | 1.30.242.212/2200 |
| yes | latching | 2 x 60° | | 1.30.242.311/22xx | 1.30.242.312/2200 |
| yes | latching | 2 x 90° | | 1.30.242.136/22xx | 1.30.242.137/2200 |
| no | momentary | 1 x 40° | | 1.30.242.511/02xx | 1.30.242.512/0200 |
| no | momentary | 2 x 40° | | 1.30.242.536/02xx | 1.30.242.537/0200 |
| no | latching 1 x 90° and momentary 1 x 40° | 1 x 90° and 1 x 40° | | 1.30.242.936/02xx | 1.30.242.937/0200 |
| no | latching | 1 x 90°, form L | | 1.30.242.611/02xx | 1.30.242.612/0200 |
| no | latching | 1 x 90°, form V | | 1.30.242.711/02xx | 1.30.242.712/0200 |
| no | latching | 2 x 60° | | 1.30.242.811/02xx | 1.30.242.812/0200 |
| no | latching | 2 x 90° | | 1.30.242.636/02xx | 1.30.242.637/0200 |

Technical data see page 2 - 110

xx = Front ring colour: black = 01, slate grey = 07, silver grey = 08; other colours on request.

Included: Ring nut with claw.

On selector switches with 3 switching positions (e.g. 2 x 90 degrees), either the left-hand or right-hand contact block is activated, depending on the sense of rotation. A third contact block arranged in the centre would be actuated with either sense of rotation.

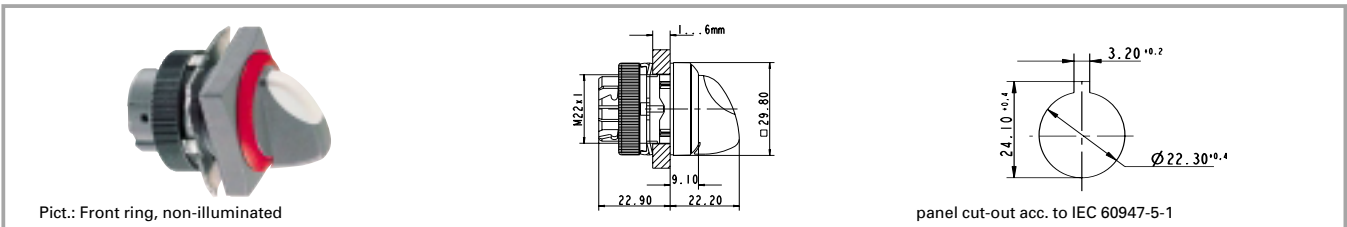
RAFIX 22 QR selector switch, square collar, short handle

Pict.: Front ring, non-illuminated

panel cut-out acc. to IEC 60947-5-1

| Illuminability | Contact function | Rotating angle | Drehwinkel | Order no. | |
|----------------|--|---------------------|------------|--------------------|--------------------------|
| | | | | Plastic front ring | Metal front ring |
| yes | momentary | 1 x 40° | | 1.30.242.051/22xx | 1.30.242.052/2200 |
| yes | momentary | 2 x 40° | | 1.30.242.076/22xx | 1.30.242.077/2200 |
| yes | latching 1 x 90° and momentary 1 x 40° | 1 x 90° and 1 x 40° | | 1.30.242.476/22xx | 1.30.242.477/2200 |
| yes | latching | 1 x 90°, form L | | 1.30.242.151/22xx | 1.30.242.152/2200 |
| yes | latching | 1 x 90°, form V | | 1.30.242.251/22xx | 1.30.242.252/2200 |
| yes | latching | 2 x 60° | | 1.30.242.351/22xx | 1.30.242.352/2200 |
| yes | latching | 2 x 90° | | 1.30.242.176/22xx | 1.30.242.177/2200 |
| no | momentary | 1 x 40° | | 1.30.242.551/02xx | 1.30.242.552/0200 |
| no | momentary | 2 x 40° | | 1.30.242.576/02xx | 1.30.242.577/0200 |
| no | latching 1 x 90° and momentary 1 x 40° | 1 x 90° and 1 x 40° | | 1.30.242.976/02xx | 1.30.242.977/0200 |
| no | latching | 1 x 90°, form L | | 1.30.242.651/02xx | 1.30.242.652/0200 |
| no | latching | 1 x 90°, form V | | 1.30.242.751/02xx | 1.30.242.752/0200 |
| no | latching | 2 x 60° | | 1.30.242.851/02xx | 1.30.242.852/0200 |
| no | latching | 2 x 90° | | 1.30.242.676/02xx | 1.30.242.677/0200 |

Technical data see page 2 - 110

xx = Front ring colour: black = 01, slate grey = 07, silver grey = 08; other colours on request.

Included: Ring nut with claw.

On selector switches with 3 switching positions (e.g. 2 x 90 degrees), either the left-hand or right-hand contact block is activated, depending on the sense of rotation.

A third contact block arranged in the centre would be actuated with either sense of rotation.

The following selector switches with silver grey plastic front ring are stock items:

 Illuminated: **1.30.242.051/2208**, **1.30.242.076/2208**, **1.30.242.151/2208**, **1.30.242.251/2208**, **1.30.242.351/2208**

 Non-illuminated: **1.30.242.551/0208**, **1.30.242.576/0208**, **1.30.242.651/0208**, **1.30.242.751/0208**, **1.30.242.851/0208**

RAFIX 22 QR selector switch, square collar, long handle



Pict.: Front ring, black, non-illuminated

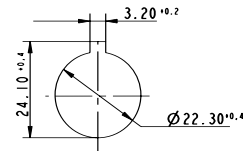
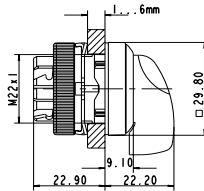

panel cut-out acc. to IEC 60947-5-1

| Illuminability | Contact function | Rotating angle | Drehwinkel | Order no. | |
|----------------|--|---------------------|------------|--------------------|-------------------|
| | | | | Plastic front ring | Metal front ring |
| yes | momentary | 1 x 40° | | 1.30.242.061/22xx | 1.30.242.062/2200 |
| yes | momentary | 2 x 40° | | 1.30.242.086/22xx | 1.30.242.087/2200 |
| yes | latching 1 x 90° and momentary 1 x 40° | 1 x 90° and 1 x 40° | | 1.30.242.486/22xx | 1.30.242.487/2200 |
| yes | latching | 1 x 90°, form L | | 1.30.242.161/22xx | 1.30.242.162/2200 |
| yes | latching | 1 x 90°, form V | | 1.30.242.261/22xx | 1.30.242.262/2200 |
| yes | latching | 2 x 60° | | 1.30.242.361/22xx | 1.30.242.362/2200 |
| yes | latching | 2 x 90° | | 1.30.242.186/22xx | 1.30.242.187/2200 |
| no | momentary | 1 x 40° | | 1.30.242.561/02xx | 1.30.242.562/0200 |
| no | momentary | 2 x 40° | | 1.30.242.586/02xx | 1.30.242.587/0200 |
| no | latching 1 x 90° and momentary 1 x 40° | 1 x 90° and 1 x 40° | | 1.30.242.986/02xx | 1.30.242.987/0200 |
| no | latching | 1 x 90°, form L | | 1.30.242.661/02xx | 1.30.242.662/0200 |
| no | latching | 1 x 90°, form V | | 1.30.242.761/02xx | 1.30.242.762/0200 |
| no | latching | 2 x 60° | | 1.30.242.861/02xx | 1.30.242.862/0200 |
| no | latching | 2 x 90° | | 1.30.242.686/02xx | 1.30.242.687/0200 |

Technical data see page 2 - 110

xx = Front ring colour: black = 01, slate grey = 07, silver grey = 08; other colours on request.

Included: Ring nut with claw.

On selector switches with 3 switching positions (e.g. 2 x 90 degrees), either the left-hand or right-hand contact block is activated, depending on the sense of rotation. A third contact block arranged in the centre would be actuated with either sense of rotation.

RAFIX 22 QR keylock switch



2

Technical data

General information

Form of lens see order block
Colout of front ring see order block
Form of collar see order block

Dimensions

Length of collar see order block
Width of collar see order block
Overall height 30.6 mm
Mounting depth with contact block without cable 56.4 mm
Mounting hole 22.3 mm
Key grid 50 x 30 mm
Diameter of collar see order block

Mechanical design

Mounting ring nut
Contact function see order block
Illuminability no
Lock Ronis
Wafers 4
Lock type 455
Main key no
Symmetric key no
Rotating angle see order block
Key removal position see order block

Mechanical characteristics

Operating force max. approx. 5 N for 1 switching element
Torque max. 2 Nm

Electrical characteristics

Protection class II

Other specifications

Operating life 0.3 million momentary / 50000 latching
Degree of protection from front side IP65
Ambient temp. operating min. -25 °
Ambient temp. operating max. +70 °
Storage temperature min. -40 °C
Storage temperature max. +80 °C
Resistance to constant environment according to IEC 600 68-2-3 and 2-30
Resistance at variable environment according to IEC 600 68-2-14 and 2-33

RAFIX 22 QR

Accessories RAFIX 22 QR keylock switch

| Description | Photo | Order no. | Page |
|---|-------|--------------------------|---------|
| RAFIX 22 QR contact block with silver contacts, with coupling, without lamp socket, screw terminals, 1 NC + 1 | | 1.20.124.017/0000 | 2 - 140 |
| RAFIX 22 QR contact block with silver contacts, with coupling, without lamp socket, cage clamp terminals, 1 | | 1.20.125.002/0000 | 2 - 140 |
| Contact block with coupling, gold contacts, RJ 12 connector, 1 NC + 1 NO, without LED | | 1.20.128.003/0000 | 2 - 147 |
| Label holder, round collar, with adhesive tape and release liner on back | | 5.07.620.010/0000 | 2 - 157 |
| Spare key for RAFIX 22 QR | | 5.58.017.001/0000 | |

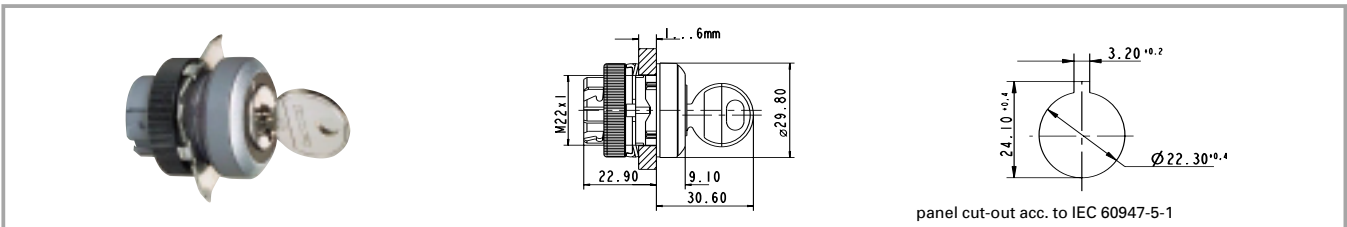
RAFIX 22 QR keylock switch, round collar

| Contact function | Rotating angle | Key removal position | Rotating angle | Order no. | |
|--|---------------------|----------------------|----------------|--------------------|--------------------------|
| | | | | Plastic front ring | Metal front ring |
| momentary | 1 x 40° | 0 | | 1.30.245.001/xxxx | 1.30.245.002/0000 |
| momentary | 2 x 40° | 0 | | 1.30.245.101/xxxx | 1.30.245.102/0000 |
| latching 1 x 90° and momentary 1 x 40° | 1 x 90° and 1 x 40° | 0 | | 1.30.245.501/xxxx | 1.30.245.502/0000 |
| latching 1 x 90° and momentary 1 x 40° | 1 x 90° and 1 x 40° | 0+2 | | 1.30.245.521/xxxx | 1.30.245.522/0000 |
| latching | 1 x 90°, form L | 0 | | 1.30.245.201/xxxx | 1.30.245.202/0000 |
| latching | 1 x 90°, form L | 0+1 | | 1.30.245.221/xxxx | 1.30.245.222/0000 |
| latching | 1 x 90°, form V | 0 | | 1.30.245.301/xxxx | 1.30.245.302/0000 |
| latching | 1 x 90°, form V | 0+1 | | 1.30.245.321/xxxx | 1.30.245.322/0000 |
| latching | 2 x 60° | 0+1+2 | | 1.30.245.731/xxxx | 1.30.245.732/0000 |
| latching | 2 x 90° | 0 | | 1.30.245.401/xxxx | 1.30.245.402/0000 |
| latching | 2 x 90° | 0+1+2 | | 1.30.245.431/xxxx | 1.30.245.432/0000 |

Technical data see page 2 - 116

xxxx = Front ring colour: black = 0100, slate grey = 0700, silver grey = 0800.

Other versions on request.

Included: Ring nut with claw.

On selector switches with 3 switching positions (e.g. 2 x 90 degrees), either the left-hand or right-hand contact block is activated, depending on the sense of rotation. A third contact block arranged in the centre would be actuated with either sense of rotation.

The following keylock switches with silver grey plastic front ring are stock items:

1.30.245.001/0800, 1.30.245.201/0800, 1.30.245.221/0800, 1.30.245.301/0800, 1.30.245.321/0800, 1.30.245.731/0800

RAFIX 22 QR keylock switch, square collar

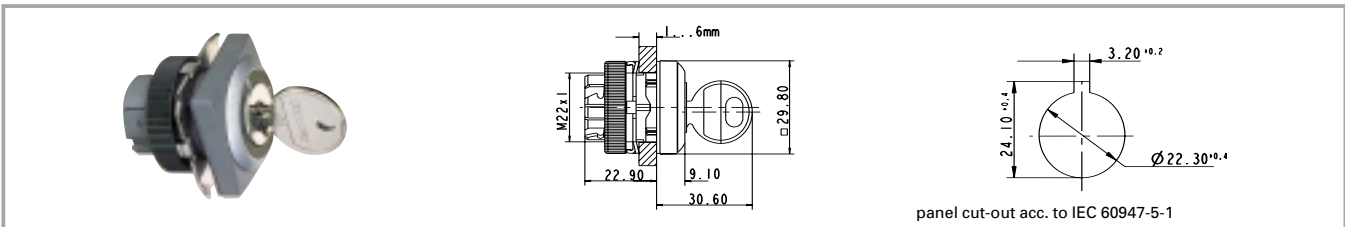

| Contact function | Rotating angle | Key removal position | Rotating angle | Order no. | |
|--|---------------------|----------------------|----------------|--------------------|--------------------------|
| | | | | Plastic front ring | Metal front ring |
| momentary | 1 x 40° | 0 | | 1.30.245.051/xxxx | 1.30.245.052/0000 |
| momentary | 2 x 40° | 0 | | 1.30.245.151/xxxx | 1.30.245.152/0000 |
| latching 1 x 90° and momentary 1 x 40° | 1 x 90° and 1 x 40° | 0 | | 1.30.245.551/xxxx | 1.30.245.552/0000 |
| latching 1 x 90° and momentary 1 x 40° | 1 x 90° and 1 x 40° | 0+2 | | 1.30.245.571/xxxx | 1.30.245.572/0000 |
| latching | 1 x 90°, form L | 0 | | 1.30.245.251/xxxx | 1.30.245.252/0000 |
| latching | 1 x 90°, form L | 0+1 | | 1.30.245.271/xxxx | 1.30.245.272/0000 |
| latching | 1 x 90°, form V | 0 | | 1.30.245.351/xxxx | 1.30.245.352/0000 |
| latching | 1 x 90°, form V | 0+1 | | 1.30.245.371/xxxx | 1.30.245.372/0000 |
| latching | 2 x 60° | 0+1+2 | | 1.30.245.781/xxxx | 1.30.245.782/0000 |
| latching | 2 x 90° | 0 | | 1.30.245.451/xxxx | 1.30.245.452/0000 |
| latching | 2 x 90° | 0+1+2 | | 1.30.245.481/xxxx | 1.30.245.482/0000 |

Technical data see page 2 - 116

xxxx = Front ring colour: black = 0100, slate grey = 0700, silver grey = 0800.

Other versions on request.

Included: Ring nut with claw.

On keylock switches with 3 switching positions (e.g. 2 x 90 degrees), either the left-hand or right-hand contact block is activated, depending on the sense of rotation. A third contact block arranged in the centre would be actuated with either sense of rotation.

The following keylock switches with silver grey plastic front ring are stock items:

1.30.245.051/0800, 1.30.245.251/0800, 1.30.245.271/0800, 1.30.245.351/0800, 1.30.245.371/0800, 1.30.245.781/0800

RAFIX 22 QR mushroom-headed pushbutton



2

Technical data

General information

| | |
|----------------------|-----------------|
| Form of lens | mushroom formed |
| Colour of mushroom | see order block |
| Colour of front ring | see order block |
| Form of collar | see order block |

Dimensions

| | |
|--------------------|-----------------|
| Length of collar | see order block |
| Width of collar | see order block |
| Overall height | 20.10 mm |
| Mounting depth | 56.4 mm |
| Mounting hole | 22.3 mm |
| Key grid | 50 x 30 mm |
| Diameter of collar | see order block |

Mechanical design

| | |
|------------------|-----------------|
| Mounting | ring nut |
| Contact function | see order block |
| Illuminability | see order block |

Mechanical characteristics

| | |
|----------------------|-------------------------------------|
| Operating force max. | approx. 5 N for 1 switching element |
| Robustness min. | 100 N |

Electrical characteristics

| | |
|------------------|----|
| Protection class | II |
|------------------|----|

Other specifications

| | |
|--------------------------------------|---------------------------------------|
| Operating life | 1000000 |
| Degree of protection from front side | IP65 |
| Storage temperature min. | -40 °C |
| Storage temperature max. | 80 °C |
| Resistance to constant environment | according to IEC 600 68-2-3 and 2-30 |
| Resistance at variable environment | according to IEC 600 68-2-14 and 2-33 |

Accessories RAFIX 22 QR mushroom-headed pushbutton

| Description | Photo | Order no. | Page |
|---|-------|-------------------|---------|
| RAFIX 22 QR contact block with silver contacts, with coupling, without lamp socket, screw terminals, 1 NC + 1 | | 1.20.124.017/0000 | 2 - 140 |
| RAFIX 22 QR contact block with gold contacts, with coupling, without lamp socket, cage clamp terminals, 1 | | 1.20.125.102/0000 | 2 - 144 |
| Contact block with coupling, gold contacts, RJ 12 connector, 1 NO, without LED | | 1.20.128.002/0000 | 2 - 147 |
| Fixing spanner for ring nut and front ring | | 5.05.800.062/0000 | 5 - 25 |

For other contact blocks, refer to the chapter „Contact blocks“; for additional accessories, refer to „RAFIX 22 QR special accessories“.

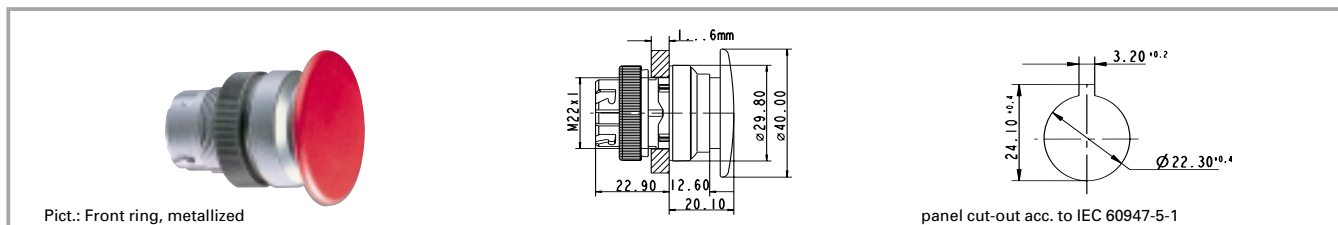
RAFIX 22 QR mushroom-headed pushbutton 40 mm, round collar

| Illuminability | Colour of mushroom | Order no. momentary | | Order no. latching | |
|----------------|--------------------|---------------------|-----------------------|--------------------|-----------------------|
| | | Plastic front ring | Metallized front ring | Plastic front ring | Metallized front ring |
| no | opaque black | 1.30.246.501/01xx | 1.30.246.502/0100 | 1.30.246.511/01xx | 1.30.246.512/0100 |
| no | opaque red | 1.30.246.501/03xx | 1.30.246.502/0300 | 1.30.246.511/03xx | 1.30.246.512/0300 |

Technical data see page 2 - 120

xx = Front ring colour: black = 01, slate grey = 07, silver grey = 08

 Order number **1.30.246.501/0308** (with silver grey plastic front ring) is a **stock item**.

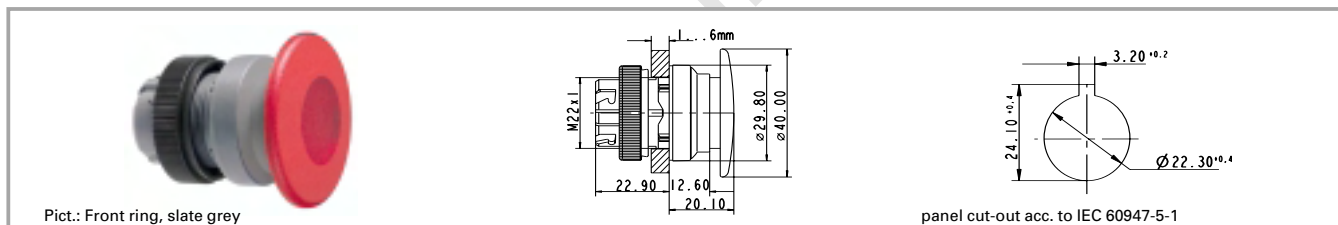
2
RAFIX 22 QR mushroom-headed pushbutton 40 mm, illuminated, round collar

| Illuminability | Colour of mushroom | Order no. momentary | | Order no. latching | |
|----------------|--------------------------------|---------------------|--------------------------|--------------------|-----------------------|
| | | Plastic front ring | Metallized front ring | Plastic front ring | Metallized front ring |
| yes | opaque red/ transparent red | 1.30.246.001/03xx | 1.30.246.002/0300 | 1.30.246.011/03xx | 1.30.246.012/0300 |

Technical data see page 2 - 120

xx = Front ring colour: black = 01, slate grey = 07, silver grey = 08

 Order number **1.30.246.001/0308** (with silver grey plastic front ring) is a **stock item**.

**RAFIX
22 QR**

RAFIX 22 QR mushroom-headed pushbutton 60 mm, round collar

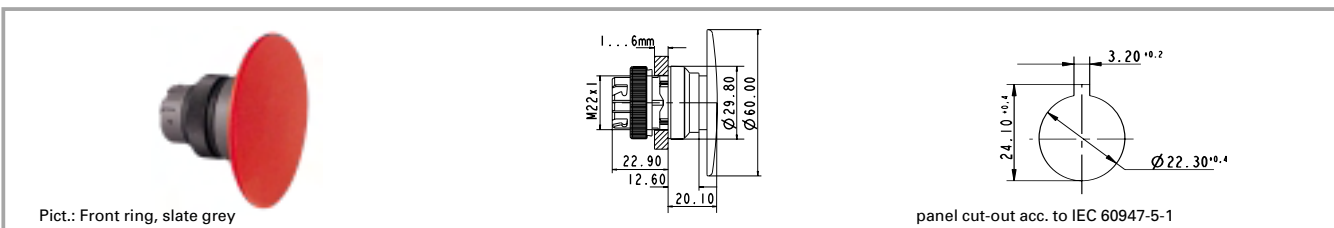

| Illuminability | Colour of mushroom | Order no. momentary | | Order no. latching | |
|----------------|--------------------|---------------------|-----------------------|--------------------|-----------------------|
| | | Plastic front ring | Metallized front ring | Plastic front ring | Metallized front ring |
| no | opaque red | 1.30.246.601/03xx | 1.30.246.602/0300 | | |

Technical data see page 2 - 120

xx = Front ring colour: black = 01, slate grey = 07, silver grey = 08

RAFIX 22 QR mushroom-headed pushbutton 40 mm, square collar

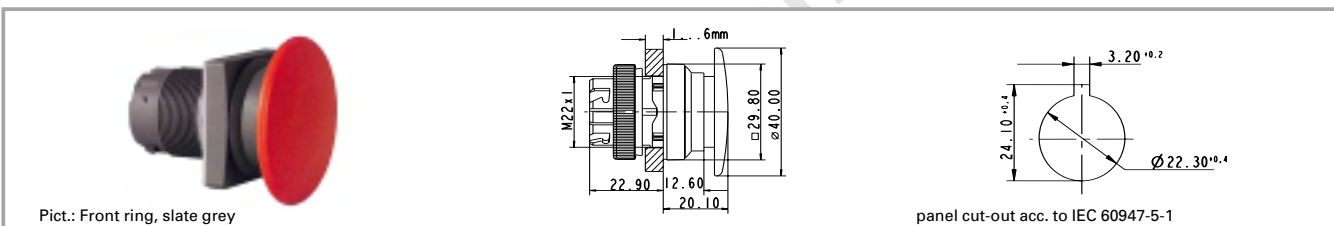

| Illuminability | Colour of mushroom | Order no. momentary | | Order no. latching | |
|----------------|--------------------|---------------------|-----------------------|--------------------|-----------------------|
| | | Plastic front ring | Metallized front ring | Plastic front ring | Metallized front ring |
| no | opaque black | 1.30.246.551/01xx | 1.30.246.552/0100 | 1.30.246.561/01xx | 1.30.246.562/0100 |
| no | opaque red | 1.30.246.551/03xx | 1.30.246.552/0300 | 1.30.246.561/03xx | 1.30.246.562/0300 |

Technical data see page 2 - 120

xx = Front ring colour: black = 01, slate grey = 07, silver grey = 08

Order number **1.30.246.551/0308** (with silver grey plastic front ring) is a **stock item**.

2

RAFIX
22 QR

RAFIX 22 QR mushroom-headed pushbutton 40 mm, illuminated, square collar

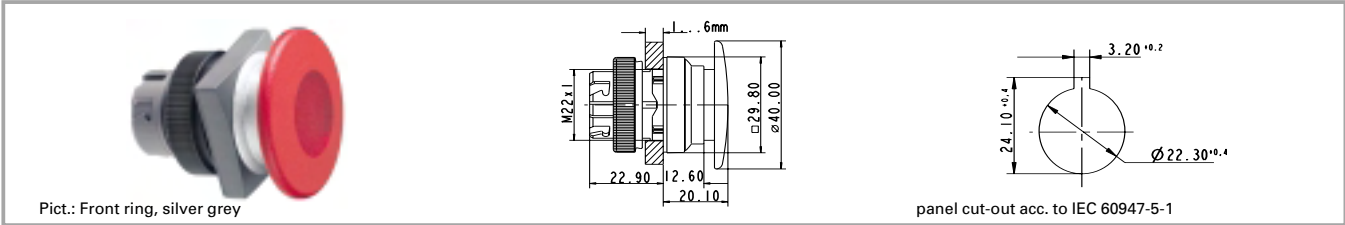

| Illuminability | Colour of mushroom | Order no. momentary | | Order no. latching | |
|----------------|--------------------------------|---------------------|--------------------------|--------------------|-----------------------|
| | | Plastic front ring | Metallized front ring | Plastic front ring | Metallized front ring |
| yes | opaque red/ transparent red | 1.30.246.051/03xx | 1.30.246.052/0300 | 1.30.246.061/03xx | 1.30.246.062/0300 |

Technical data see page 2 - 120

xx = Front ring colour: black = 01, slate grey = 07, silver grey = 08

Order number **1.30.246.051/0308** (with silver grey plastic front ring) is a **stock item**.

2

RAFIX 22 QR mushroom-headed pushbutton 60 mm, square collar

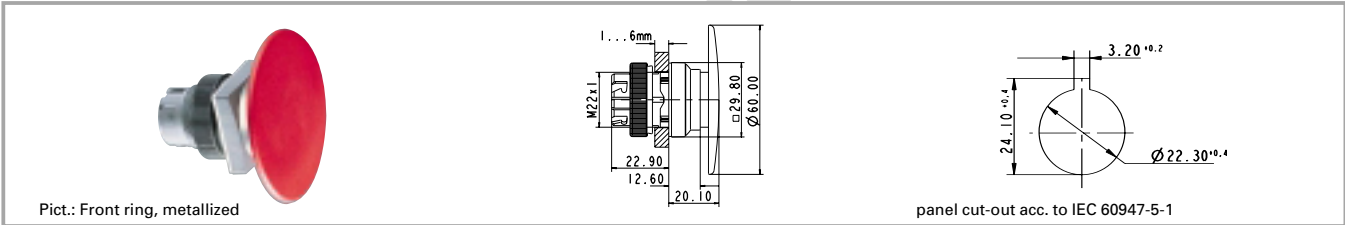

| Illuminability | Colour of mushroom | Order no. momentary | | Order no. latching | |
|----------------|--------------------|---------------------|-----------------------|--------------------|-----------------------|
| | | Plastic front ring | Metallized front ring | Plastic front ring | Metallized front ring |
| no | opaque red | 1.30.246.651/03xx | 1.30.246.652/0300 | | |

Technical data see page 2 - 120

xx = Front ring colour: black = 01, slate grey = 07, silver grey = 08

RAFIX
22 QR

RAFIX 22 QR emergency stop pushbutton, dupe-proof to EN 418

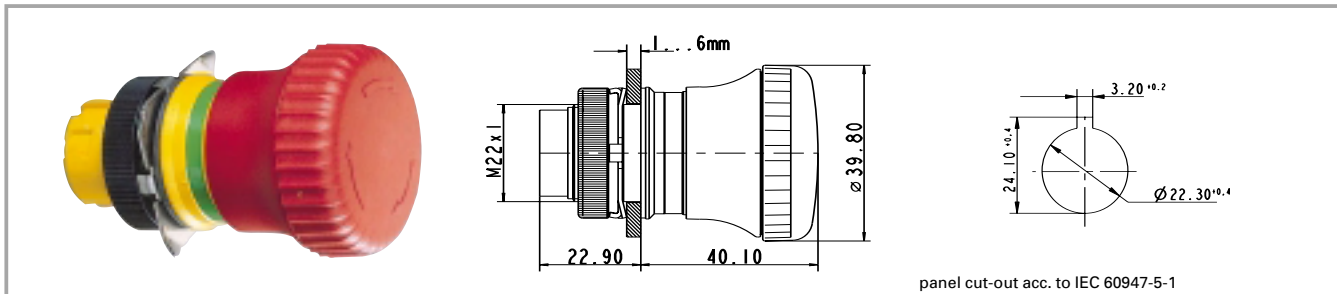

2

General data

The emergency stop pushbuttons comply with IEC 60 204, IEC 60 073, IEC 60 947 and VDE 0113 Part 1. They are designed dupe-proof according to EN 418 with a positive mechanical movement sequence. A certain operating force must be exerted at the action point in order to prevent inadvertent operation. The pushbutton latches when pressed and is reset by either turning the actuator in a clockwise direction or pulling the actuator back to the original position. The reset means depends on the model. The special shape of the actuator prevents the emergency stop pushbutton from being blocked. This means that the emergency stop process - once initiated - cannot be impeded by any jamming objects. Only use contact block 1.20.126.4xx.

Technical data

General information

Form of lens mushroom formed
Colour of lens see order block
Form of collar round

Robustness min. 100 N
Robustness acc. IEC 60947-5-5

Dimensions

Overall height see order block
Mounting depth with contact block without cable 56.4 mm
Mounting hole 22.3 mm
Key grid 50 x 30 mm
Diameter of collar 39.8 mm

Other specifications

Operating life see order block
Degree of protection from front side IP65
Ambient temp. operating min. -25 °C
Ambient temp. operating max. +70 °C
Storage temperature min. -40 °C
Storage temperature max. +80 °C

Mechanical design

Mounting ring nut
Contact function latching
Illuminability see order block

Resistance to constant environment according to IEC 600 68-2-3 and 2-30
Resistance at variable environment according to IEC 600 68-2-14 and 2-33

Mechanical characteristics

Operating force max. approx. 5 N for 1 switching element

Accessories RAFIX 22 QR emergency stop pushbutton, dupe-proof to EN 418

| Description | Photo | Order no. | Page |
|---|-------|--------------------------|---------|
| RAFIX 22 QR contact block with silver contacts, with coupling, without lamp socket, screw terminals, 1 NC | | 1.20.124.001/0000 | 2 - 140 |
| RAFIX 22 QR contact block with silver contacts, with coupling, without lamp socket, screw terminals, 2 NC | | 1.20.124.019/0000 | 2 - 140 |
| Contact block with coupling, gold contacts, RJ 12 connector, 1 NC, without LED | | 1.20.128.001/0000 | 2 - 147 |
| Fixing spanner for ring nut and front ring | | 5.05.800.062/0000 | 5 - 25 |
| Emergency stop label, yellow, round 60 mm, PVC adhesive, without legend | | 5.76.204.100/0400 | 2 - 161 |

Accessories RAFIX 22 QR emergency stop pushbutton, dupe-proof to EN 418

| Description | Photo | Order no. | Page |
|--|-------|-------------------|---------|
| Emergency stop label, yellow, round 60 mm, PVC adhesive, with legend "NOT-AUS" | | 5.76.204.101/0400 | 2 - 161 |
| Emergency stop label, yellow, round 60 mm, PVC adhesive, with legend "ARRET D'URGENCE" | | 5.76.204.102/0400 | 2 - 161 |
| Emergency stop label, yellow, round 60 mm, PVC adhesive, with legend "EMERGENCY-STOP" | | 5.76.204.103/0400 | 2 - 161 |
| Emergency stop label, yellow 36 x 64 mm, PVC adhesive, without legend | | 5.76.205.011/0400 | 2 - 161 |
| Emergency stop label, yellow, round 60 mm, rigid PVC, with legend "EMERGENCY-STOP/ARRET D'URGENCE" | | 5.76.207.002/0400 | 2 - 161 |

For other contact blocks, refer to the chapter „Contact blocks“; for additional accessories, refer to „RAFIX 22 QR special accessories“.

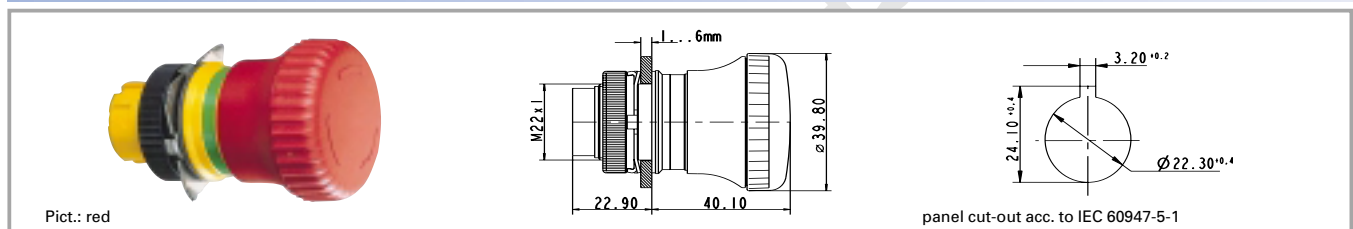
RAFIX 22 QR emergency stop pushbutton, dupe-proof to EN 418

| Form of lens | Colour of lens | Illuminability | Operating life | Order no. complete |
|-----------------------------------|----------------|----------------|----------------|--------------------------|
| mushroom formed Twist to Reset | opaque red | no | 100000 | 1.30.243.501/0300 |
| mushroom formed Pull to Reset | opaque red | no | 100000 | 1.30.243.901/0300 |

Technical data see page 2 - 124

Included: Ring nut with claw.

Switching position indication: In the non-operated condition, a green ring is visible on the side.

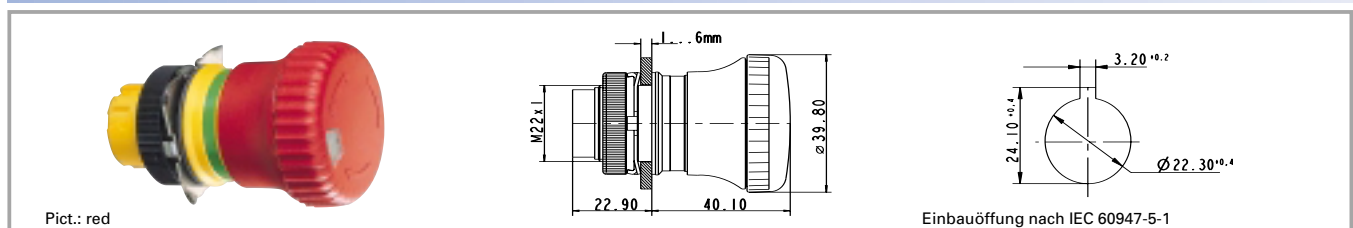
RAFIX 22 QR emergency stop pushbutton, dupe-proof to EN 418, with indication to EN 60947-1

| Form of lens | Colour of lens | Illuminability | Operating life | Order no. complete |
|-----------------------------------|----------------|----------------|----------------|--------------------------|
| mushroom formed Twist to Reset | opaque red | no | 100000 | 1.30.243.601/0300 |

Technical data see page 2 - 124

Included: Ring nut with claw.

Switching position indication: In the non-operated condition, a green ring is visible on the side.

This switching position is visible in addition from the front; a mechanical indicator integrated into the mushroom head changes from green to red when actuated.

RAFIX 22 QR emergency stop pushbutton, dupe-proof to EN 418, with keylock

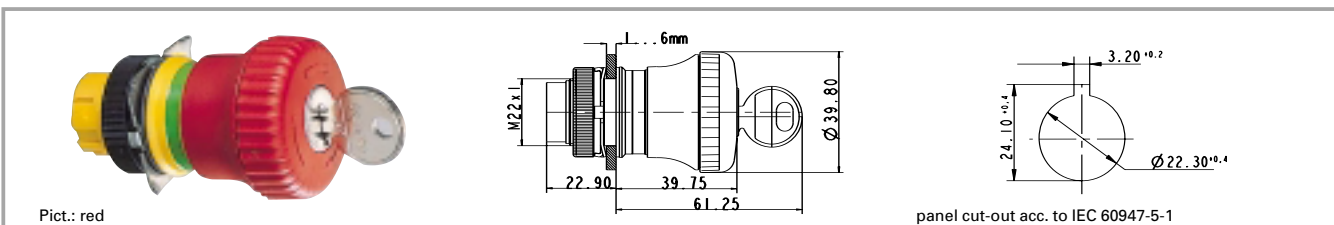

| Form of lens | Colour of lens | Illuminability | Operating life | Order no. complete |
|-----------------------------------|----------------|----------------|----------------|--------------------------|
| mushroom formed Twist to Reset | opaque red | no | 50000 | 1.30.243.701/0300 |

Technical data see page 2 - 124

Included: Ring nut with claw, 2 keys.
Switching position indication: In the non-operated condition, a green ring is visible on the side. Once actuated, the emergency stop pushbutton can only be reset with the key.

2

RAFIX 22 QR emergency stop pushbutton, dupe-proof to EN 418, illuminated

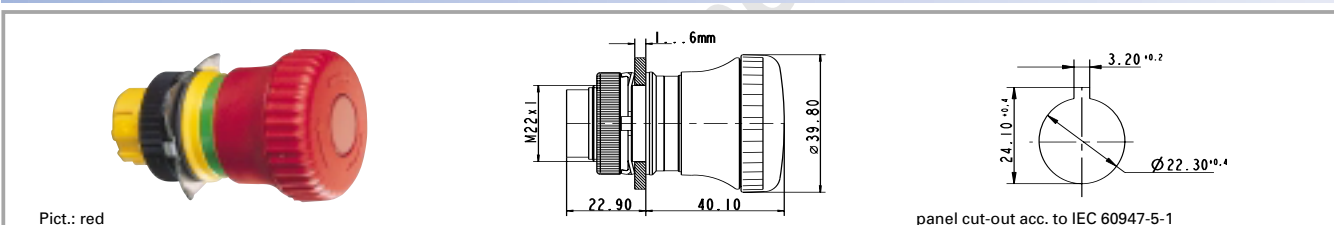

| Form of lens | Colour of lens | Illuminability | Operating life | Order no. complete |
|-----------------------------------|--------------------------------|----------------|----------------|--------------------------|
| mushroom formed Twist to Reset | opaque red/ translucent red | yes | 100000 | 1.30.243.001/0300 |

Technical data see page 2 - 124

Included: Ring nut with claw.
Switching position indication: In the non-operated condition, a green ring is visible on the side.

RAFIX
22 QR

RAFIX 22 QR twin pushbutton

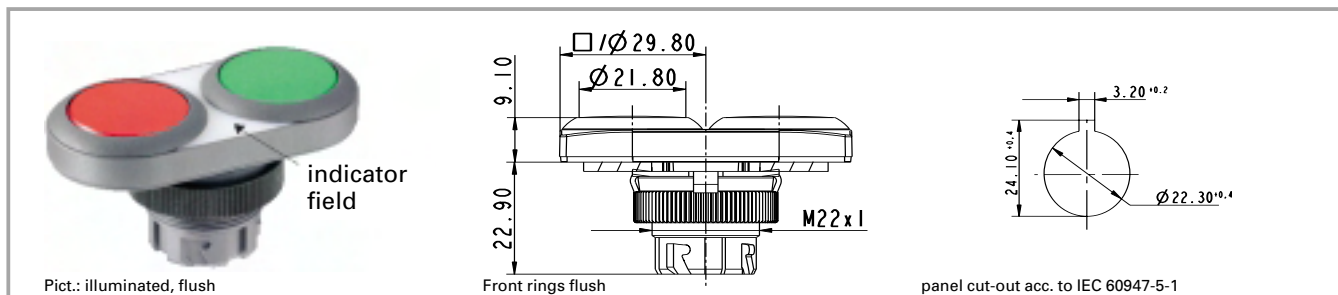

2

General data

Lens legends are oriented for vertical installation of the twin pushbutton. Only the signal indicator is illuminated on twin pushbuttons prepared for illumination. This area is opaque slate grey on versions which cannot be illuminated.

Technical data

General information

| | |
|---------------------------|-------------------------|
| Front ring form/Legending | see order block |
| Colour of lens | opaque green/opaque red |
| Colour of front ring | see order block |
| Form of collar | see order block |

Dimensions

| | |
|---|------------|
| Length of collar | 59.6 mm |
| Width of collar | 29.8 mm |
| Overall height | 9.1 mm |
| Mounting depth with contact block without cable | 56.4 mm |
| Mounting hole | 22.3 mm |
| Key grid | 50 x 30 mm |

Mechanical design

| | |
|------------------|-----------------|
| Mounting | ring nut |
| Contact function | momentary |
| Illuminability | see order block |

Mechanical characteristics

| | |
|----------------------|-------------------------------------|
| Operating force max. | approx. 5 N for 1 switching element |
| Robustness min. | 100 N |

Other specifications

| | |
|--------------------------------------|---------------------------------------|
| Degree of protection from front side | IP65 |
| Ambient temp. operating min. | -25 °C |
| Ambient temp. operating max. | +70 °C |
| Storage temperature max. | +80 °C |
| Resistance to constant environment | according to IEC 600 68-2-3 and 2-30 |
| Resistance at variable environment | according to IEC 600 68-2-14 and 2-33 |

Accessories RAFIX 22 QR twin pushbutton

| Description | Photo | Order no. | Page |
|---|-------|-------------------|---------|
| RAFIX 22 QR contact block with silver contacts, with coupling and lamp socket, screw terminals, 1 NO, 1 NC | | 1.20.124.025/0000 | 2 - 141 |
| RAFIX 22 QR contact block with gold contacts, with coupling and lamp socket, cage clamp terminals, 1 NO, 1 NC | | 1.20.125.125/0000 | 2 - 145 |
| Fixing spanner for ring nut and front ring | | 5.05.800.062/0000 | 5 - 25 |

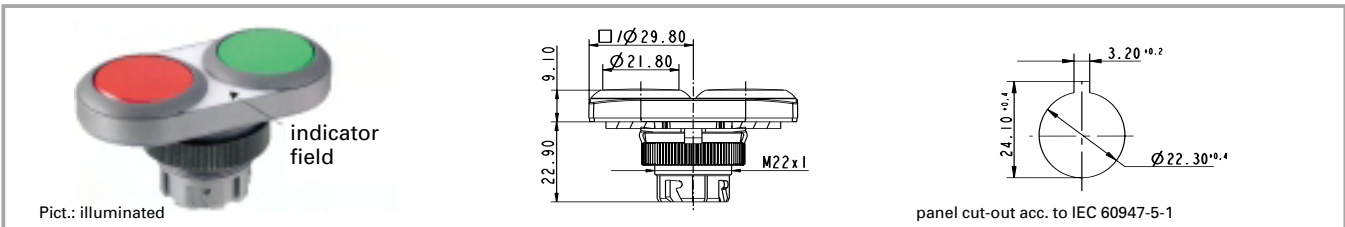
RAFIX 22 QR twin pushbutton, oval collar

| Illuminability | Colour of lens | Front ring form/Legending | Order no. | |
|----------------|-------------------------|---------------------------|--------------------|-------------------|
| | | | Plastic front ring | Metal front ring |
| yes | opaque green/opaque red | flush/ none | 1.30.241.001/22xx | 1.30.241.021/2200 |
| yes | opaque green/opaque red | flush/red 0; green I | 1.30.241.002/22xx | 1.30.241.022/2200 |
| yes | opaque green/opaque red | protruding/none | 1.30.241.401/22xx | 1.30.241.421/2200 |
| no | opaque green/opaque red | flush/ none | 1.30.241.101/07xx | 1.30.241.121/0700 |
| no | opaque green/opaque red | flush/red 0; green I | 1.30.241.102/07xx | 1.30.241.122/0700 |
| no | opaque green/opaque red | protruding/none | 1.30.241.501/07xx | 1.30.241.521/0700 |

Technical data see page 2 - 128

xx = Front ring colour: black = 01, slate grey = 07, silver grey = 08

Either the left-hand or right-hand contact block is actuated, depending on the button pressed. A third contact block arranged in the centre would be actuated by either button.

2
**RAFIX
22 QR**

RAFIX 22 QR twin pushbutton, rectangular collar

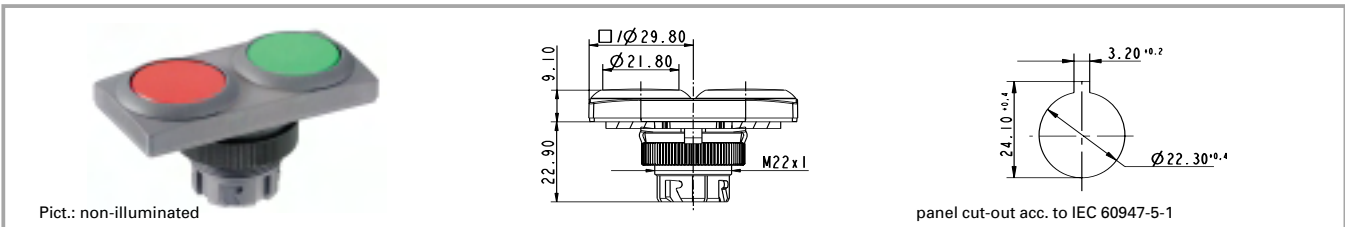

| Illuminability | Colour of lens | Front ring form/Legending | Order no. | |
|----------------|-------------------------|---------------------------|--------------------|-------------------|
| | | | Plastic front ring | Metal front ring |
| yes | opaque green/opaque red | flush/ none | 1.30.241.051/22xx | 1.30.241.071/2200 |
| yes | opaque green/opaque red | flush/red 0; green I | 1.30.241.052/22xx | 1.30.241.072/2200 |
| yes | opaque green/opaque red | protruding/none | 1.30.241.451/22xx | 1.30.241.471/2200 |
| no | opaque green/opaque red | flush/ none | 1.30.241.151/07xx | 1.30.241.171/0700 |
| no | opaque green/opaque red | flush/red 0; green I | 1.30.241.152/07xx | 1.30.241.172/0700 |
| no | opaque green/opaque red | protruding/none | 1.30.241.551/07xx | 1.30.241.571/0700 |

Technical data see page 2 - 128

xx = Front ring colour: black = 01, slate grey = 07, silver grey = 08

Either the left-hand or right-hand contact block is actuated, depending on the button pressed. A third contact block arranged in the centre would be actuated by either button.

2

RAFIX
22 QR

RAFIX 22 QR potentiometer drive

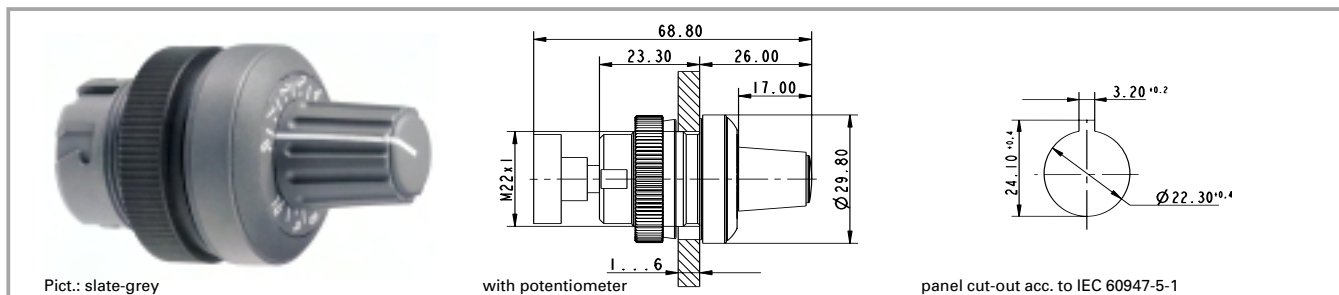

2

Technical data

General information

| | |
|------------------|-----------------|
| Form of lens | knob size |
| Colour of handle | see order block |
| Front ring | see order block |
| Form of collar | see order block |

Dimensions

| | |
|--------------------|----------------------------|
| Length of collar | see order block |
| Width of collar | see order block |
| Overall height | 26 mm |
| Mounting depth | according to potentiometer |
| Mounting hole | 22.3 mm |
| Key grid | 50 x 30 mm |
| Diameter of collar | see order block |

Mechanical design

| | |
|----------|----------|
| Mounting | ring nut |
|----------|----------|

Mechanical characteristics

| | |
|-----------------|-------|
| Robustness min. | 100 N |
|-----------------|-------|

Other specifications

| | |
|--------------------------------------|---------------------------------------|
| Degree of protection from front side | IP65 |
| Storage temperature min. | -40 °C |
| Storage temperature max. | +80 °C |
| Resistance to constant environment | according to IEC 600 68-2-3 and 2-30 |
| Resistance at variable environment | according to IEC 600 68-2-14 and 2-33 |

Accessories RAFIX 22 QR potentiometer drive

| Description | Photo | Order no. | Page |
|--|--|--------------------------|--------|
| Fixing spanner for ring nut and front ring |  | 5.05.800.062/0000 | 5 - 25 |

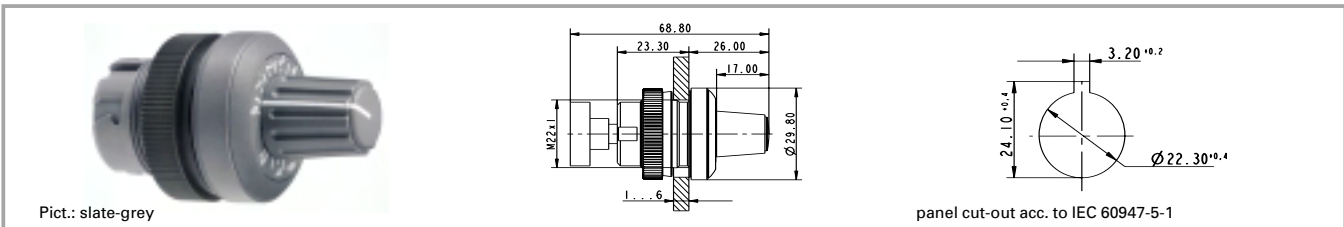
RAFIX 22 QR potentiometer drive, round collar

| Front ring | Colour of handle | Order no. complete |
|--------------------|-------------------|--------------------|
| metal | opaque slate-grey | 1.30.248.051/0000 |
| plastic slate-grey | opaque slate-grey | 1.30.248.001/0700 |
| plastic silber | opaque slate-grey | 1.30.248.001/0800 |
| metal | opaque black | 1.30.248.061/0000 |
| plastic slate-grey | opaque black | 1.30.248.011/0700 |
| plastic silber | opaque black | 1.30.248.011/0800 |

Technical data see page 2 - 132

For potentiometers with 6 mm shaft diameter. For potentiometers with 50 mm shaft length. Potentiometer not included.

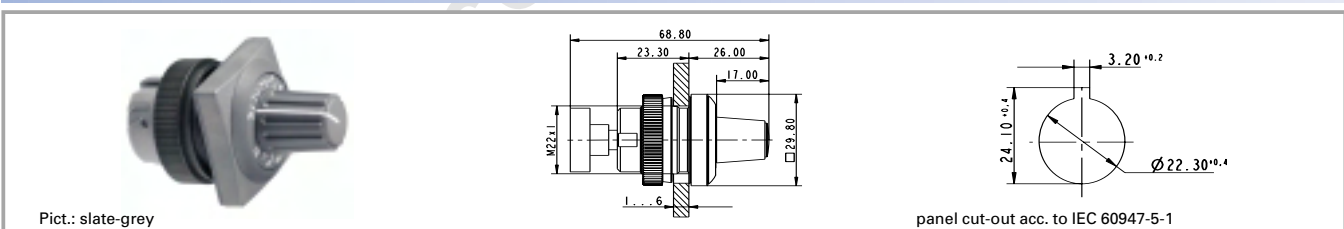
2
**RAFIX
22 QR**
RAFIX 22 QR potentiometer drive, square collar

| Front ring | Colour of handle | Order no. complete |
|--------------------|-------------------|--------------------|
| metal | opaque slate-grey | 1.30.248.071/0000 |
| plastic slate-grey | opaque slate-grey | 1.30.248.021/0700 |
| plastic silber | opaque slate-grey | 1.30.248.021/0800 |
| metal | opaque black | 1.30.248.081/0000 |
| plastic slate-grey | opaque black | 1.30.248.031/0700 |
| plastic silber | opaque black | 1.30.248.031/0800 |

Technical data see page 2 - 132

For potentiometers with 6 mm shaft diameter. For potentiometers with 50 mm shaft length. Potentiometer not included.

RAFIX 22 QR buzzer

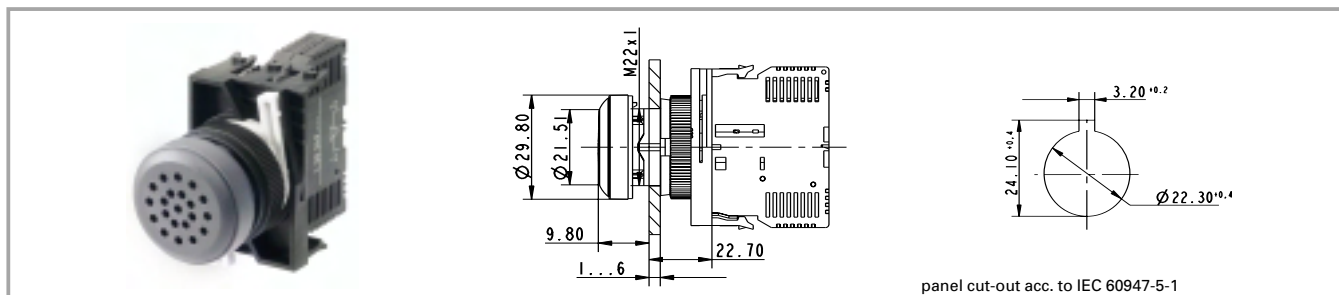

2

Technical data

General information

| | |
|----------------|-------------------|
| Form of lens | flat lens |
| Colour of lens | opaque slate-grey |
| Form of collar | see order block |
| Sound | see order block |

Dimensions

| | |
|--------------------|-----------------|
| Length of collar | see order block |
| Width of collar | see order block |
| Overall height | 9.8 mm |
| Mounting depth | 56.4 mm |
| Mounting hole | 22.3 mm |
| Key grid | 50 x 30 mm |
| Diameter of collar | see order block |

Mechanical design

| | |
|----------|----------|
| Mounting | ring nut |
|----------|----------|

Acoustic characteristics

| | |
|-----------------------------------|-----------------|
| Sonic pressure, 1 m distance min. | see order block |
|-----------------------------------|-----------------|

Electrical characteristics

| | |
|----------------------|-----------------|
| Operating voltage DC | see order block |
| Input current | see order block |
| Sound frequency | see order block |

Mechanical characteristics

| | |
|-----------------|-------|
| Robustness min. | 100 N |
|-----------------|-------|

Other specifications

| | |
|--------------------------------------|---------------------------------------|
| Degree of protection from front side | IP65 |
| Storage temperature min. | -40 °C |
| Storage temperature max. | +80 °C |
| Resistance to constant environment | according to IEC 600 68-2-3 and 2-30 |
| Resistance at variable environment | according to IEC 600 68-2-14 and 2-33 |

RAFIX
22 QR

Accessories RAFIX 22 QR buzzer

| Description | Photo | Order no. | Page |
|--|--|--------------------------|--------|
| Fixing spanner for ring nut and front ring |  | 5.05.800.062/0000 | 5 - 25 |

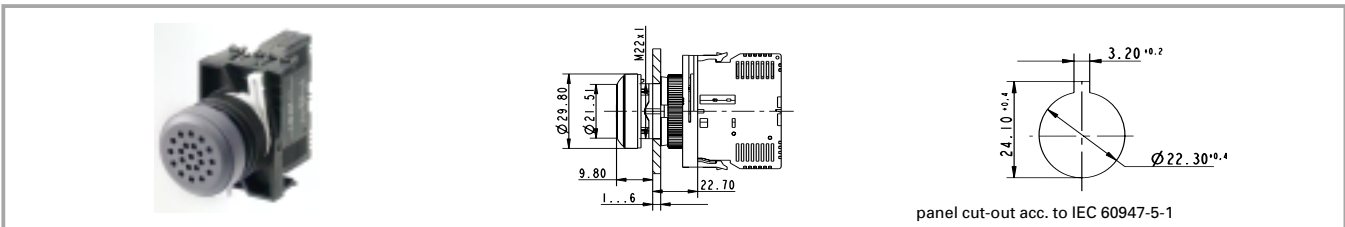
RAFIX 22 QR buzzer, round collar

| Operating voltage DC | Input current | Sound | Sonic pressure, 1 m distance min. | Sound frequency | Order no. complete |
|----------------------|---------------|-----------------|-----------------------------------|-----------------|--------------------|
| 12 V | 25 mA | continuous beep | 70 dB | | 1.30.249.002/0000 |
| 24 V | 25 mA | continuous beep | 70 dB | | 1.30.249.001/0000 |

Technical data see page 2 - 134

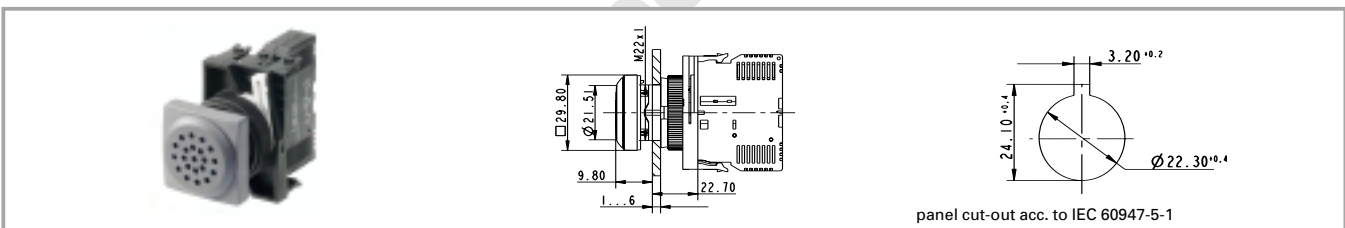
RAFIX 22 QR buzzer, square collar

| Operating voltage DC | Input current | Sound | Sonic pressure, 1 m distance min. | Sound frequency | Order no. complete |
|----------------------|---------------|-----------------|-----------------------------------|-----------------|--------------------|
| 12 V | 25 mA | continuous beep | 70 dB | | 1.30.249.022/0000 |
| 24 V | 25 mA | continuous beep | 70 dB | | 1.30.249.021/0000 |

Technical data see page 2 - 134

RAFIX 22 QR signal indicator



2

Technical data

General information

| | |
|----------------|-----------------|
| Form of lens | flat lens |
| Colour of lens | see order block |
| Form of collar | see order block |

Dimensions

| | |
|--------------------|-----------------|
| Length of collar | see order block |
| Width of collar | see order block |
| Overall height | 9.4 mm |
| Mounting depth | 56.4 mm |
| Mounting hole | 22.3 mm |
| Key grid | 50 x 30 mm |
| Diameter of collar | see order block |

Mechanical design

| | |
|----------------|----------|
| Mounting | ring nut |
| Illuminability | yes |

Electrical characteristics

| | |
|------------------|----|
| Protection class | II |
|------------------|----|

Other specifications

| | |
|--------------------------------------|---------------------------------------|
| Degree of protection from front side | IP65 |
| Ambient temp. operating min. | -25 °C |
| Ambient temp. operating max. | +70 °C |
| Storage temperature min. | -40 °C |
| Storage temperature max. | +80 °C |
| Resistance to constant environment | according to IEC 600 68-2-3 and 2-30 |
| Resistance at variable environment | according to IEC 600 68-2-14 and 2-33 |

RAFIX 22 QR

Accessories RAFIX 22 QR signal indicator

| Description | Photo | Order no. | Page |
|---|-------|--------------------------|---------|
| RAFIX 22 QR lamp socket assembly, screw terminals, with coupling | | 1.71.213.001/0000 | 2 - 150 |
| RAFIX 22 QR lamp socket assembly, screw terminals, with coupling, diode and series resistor 130 V | | 1.71.213.004/0000 | 2 - 150 |
| RAFIX 22 QR lamp socket assembly, cage clamp terminals, with coupling | | 1.71.214.001/0000 | 2 - 150 |
| Fixing spanner for ring nut and front ring | | 5.05.800.062/0000 | 5 - 25 |
| Legend insert without legend | | 5.70.803.000/2000 | |

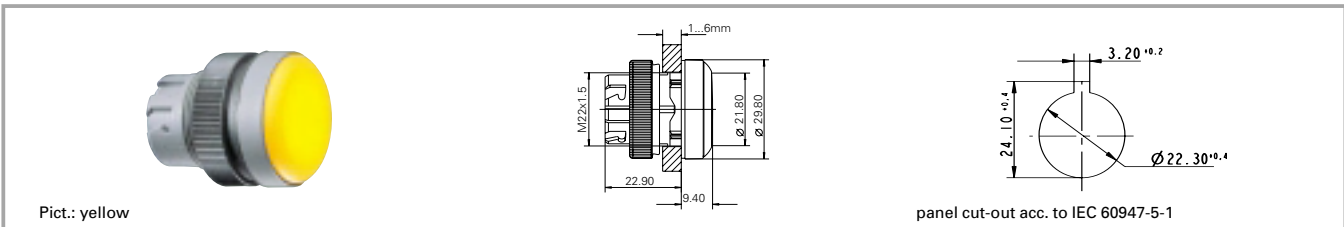
RAFIX 22 QR signal indicator, round collar

| Colour of lens | Form of collar | Order no. complete |
|------------------------|----------------|--------------------------|
| transparent colourless | round | 1.74.505.501/1000 |
| transparent red | round | 1.74.505.501/1300 |
| transparent yellow | round | 1.74.505.501/1400 |
| transparent green | round | 1.74.505.501/1500 |
| transparent blue | round | 1.74.505.501/1600 |

Technical data see page 2 - 136

Accessories:

Legend insert without legend: 5.70.803.000/2000

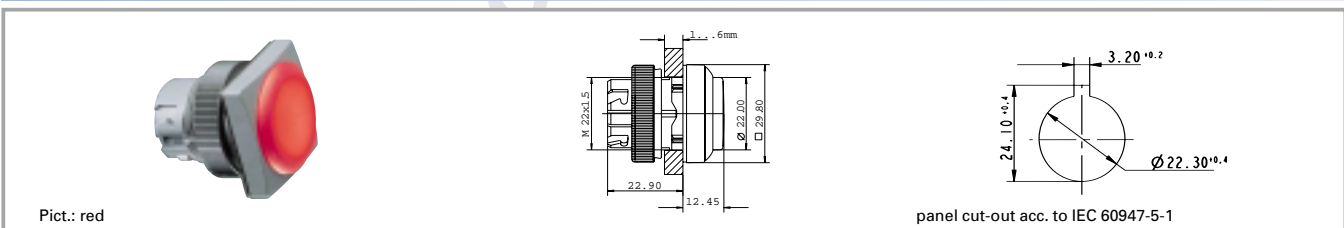
2
**RAFIX
22 QR**
RAFIX 22 QR signal indicator, square collar

| Colour of lens | Form of collar | Order no. complete |
|------------------------|----------------|--------------------------|
| transparent colourless | square | 1.74.505.551/1000 |
| transparent red | square | 1.74.505.551/1300 |
| transparent yellow | square | 1.74.505.551/1400 |
| transparent green | square | 1.74.505.551/1500 |
| transparent blue | square | 1.74.505.551/1600 |

Technical data see page 2 - 136

Accessories:

Legend insert without legend: 5.70.803.000/2000

RAFIX 22 QR contact blocks with silver contacts, screw terminals and cage clamp terminals



Pict.: Silver contacts, 1 NC, cage clamp terminals

Silver contacts, 2 NC, screw terminals

Assembly

2

General data

Most of the values specified apply to both screw terminal and cage clamp terminal versions. Any deviating values specific to the cage clamp version are given in parentheses ().

Technical data

| | | | |
|---|--|---|--|
| Dimensions | | Positive opening travel | 3 mm |
| Length | 39.5 mm | Operating speed | 5 ... 1000 mm/s |
| Width | 10 mm | | |
| Height | 46 mm | Electrical characteristics acc. to IEC 61058 | |
| Mounting depth without cable | 56.4 mm | Resistive load AC | 10 A/250 V; 7.5 A/400 V |
| | | Motor load AC | 6 A/250 V; 4 A/400 V (5 A/250 V) |
| Mechanical design | | Peak input current filament lamp AC | 36 A |
| Mounting | snap on coupling and actuator | Peak capacity input current AC | 100 A |
| Contact system | bridgecontact self cleaning | Protection class | II |
| Contact materials | Ag | Lamp characteristics | |
| Contact arrangement | see order block | Lamp socket | BA 9 s |
| NC contact forcibly actuated acc. to IEC 60947-5-1 | yes | Other specifications | |
| Terminals | see order block | Operating life at 10 A/250 V AC | 500000 (70000) |
| Terminal marking | colour encoded | Switching reliability at 24V/5mA DC | 10 x 10 ⁻⁶ |
| Robustness | 100 N | Approvals | ENEC, cURus (UL + CSA) |
| Operating force | approx. 5 N for 1 contact element | Robustness | acc. IEC 60947-5-5 |
| Wire range solid wires without wire end sleeves | 2 x 0.75 ... 2.5 mm ² | Corresponding to CE | acc. EU-guideline N 72/73 |
| Wire range stranded wires without wire end sleeves | 2 x 1.0 ... 1.5 (2 x 0.08 ... 2.5) mm ² | Shock resistance acc. to IEC 60068-2-27 | 50 g at 11 ms, amplitude half sinusoidal |
| Wire range with wire end sleeves | 2 x 0.75 ... 1.5 mm ² | Resistance to vibrations acc. to IEC 60068-2-6 | 10 g at 40 ... 500 Hz |
| Electrical characteristics acc. to IEC 60947 | | Ambient temp. operating min. | -25 °C |
| Rated insulation voltage AC/DC | 400 V | Ambient temp. operating max. | +70°C (+50°C) |
| Rated peak voltage | 6000 V | Storage temperature min. | -40 °C |
| Rated operating current I _e AC 12 | 10 A | Storage temperature max. | +80 °C |
| Rated operating current I _e AC-15 | 125 V/10 A, 250 V/6 A, 400 V/3.5 A | Flame class acc. to UL 94 | V 0 |
| Rated operating current I _e DC-13 Q300 | 24V/2.75A, 60V/1.1A, 125V/0.55A, 250V/0.275A | Hot wire ignition acc. to IEC 60695-2-1 | yes |
| Degree of pollution | 3 | Resistance to constant environment | IEC 600 68-2-3 and 2-30 |
| | | Resistance at variable environment | IEC 600 68-2-14 and 2-33 |

Accessories RAFIX 22 QR contact blocks with silver contacts, screw terminals and cage clamp terminals

| Description | Photo | Order no. | Page |
|--|-------|--------------------------|---------|
| Coupling with reference numbers 1-3-2 | | 5.05.510.935/0000 | 2 - 158 |
| Coupling with reference numbers 1/2-5/6-3/4 | | 5.05.510.936/0000 | 2 - 158 |
| Marking tag for contact blocks/lamp sockets with screw terminals | | 5.40.010.131/0000 | 2 - 160 |

RAFIX 22 QR contact block with silver contacts



| Terminals | Contact arrangement | Contact materials | Lamp socket | Order no. complete |
|-----------------|---------------------|-------------------|-------------|--------------------------|
| screw terminals | 1 NC | Ag | | 5.00.100.139/0000 |
| screw terminals | 1 NO | Ag | | 5.00.100.140/0000 |
| screw terminals | 2 NC | Ag | | 5.00.100.141/0000 |
| screw terminals | 2 NO | Ag | | 5.00.100.142/0000 |
| screw terminals | 1 NC + 1 NO | Ag | | 5.00.100.143/0000 |
| clamp cage | 1 NC | Ag | | 5.00.100.144/0000 |
| clamp cage | 1 NO | Ag | | 5.00.100.145/0000 |

Technical data see page 2 - 138

RAFIX 22 QR contact block assembly, with coupling, without lamp socket, silver contacts

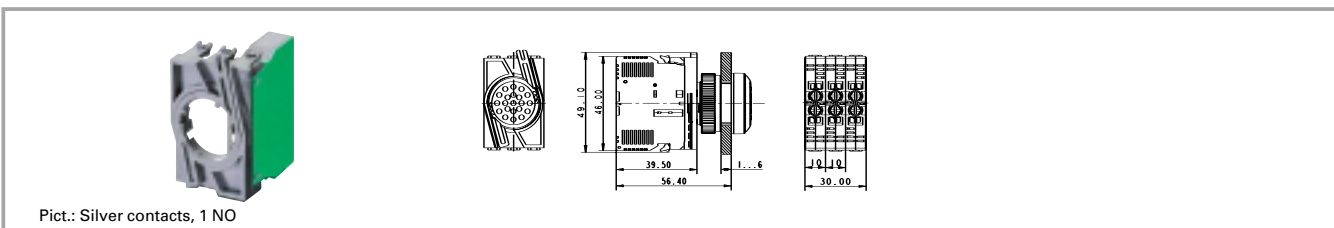

| Terminals | Contact arrangement | Contact materials | Lamp socket | Order no. complete |
|-----------------|------------------------------|-------------------|-------------|--------------------------|
| screw terminals | 1 NC | Ag | | 1.20.124.001/0000 |
| screw terminals | 1 NO | Ag | | 1.20.124.002/0000 |
| screw terminals | 1 NC, 1 NC | Ag | | 1.20.124.003/0000 |
| screw terminals | 1 NO , 1 NO | Ag | | 1.20.124.004/0000 |
| screw terminals | 1 NO , 1 NC | Ag | | 1.20.124.005/0000 |
| screw terminals | 1 NC + 1 NO | Ag | | 1.20.124.017/0000 |
| screw terminals | 1 NC + 1 NO , 1 NC + 1 NO | Ag | | 1.20.124.018/0000 |
| screw terminals | 2 NC | Ag | | 1.20.124.019/0000 |
| screw terminals | 2 NO | Ag | | 1.20.124.020/0000 |
| clamp cage | 1 NC | Ag | | 1.20.125.001/0000 |
| clamp cage | 1 NO | Ag | | 1.20.125.002/0000 |
| clamp cage | 1 NC, 1 NC | Ag | | 1.20.125.003/0000 |
| clamp cage | 1 NO , 1 NO | Ag | | 1.20.125.004/0000 |
| clamp cage | 1 NO , 1 NC | Ag | | 1.20.125.005/0000 |

Technical data see page 2 - 138

Contact arrangement example (1 NO = 1 normally open contact, 1 NC = 1 normally closed contact)

1 NO, 1 NC = **Two separate contact blocks** are mounted on the coupling: One with a normally open contact and one with a normally closed contact

1 NC + 1 NO = **One contact block with double contacts** (1 normally closed and 1 normally open) is mounted on the coupling.

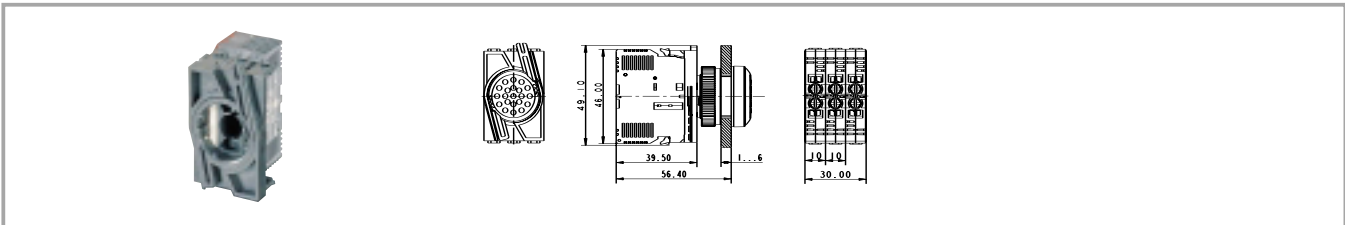
RAFIX 22 QR contact block assembly, with coupling and lamp socket, silver contacts

| Terminals | Contact arrangement | Contact materials | Lamp socket | Order no. complete |
|-----------------|------------------------------|-------------------|-------------|--------------------------|
| screw terminals | 1 NC | Ag | BA 9 s | 1.20.124.021/0000 |
| screw terminals | 1 NO | Ag | BA 9 s | 1.20.124.022/0000 |
| screw terminals | 1 NC, 1 NC | Ag | BA 9 s | 1.20.124.023/0000 |
| screw terminals | 1 NO , 1 NO | Ag | BA 9 s | 1.20.124.024/0000 |
| screw terminals | 1 NO , 1 NC | Ag | BA 9 s | 1.20.124.025/0000 |
| screw terminals | 1 NC + 1 NO | Ag | BA 9 s | 1.20.124.027/0000 |
| screw terminals | 1 NC + 1 NO , 1 NC + 1 NO | Ag | BA 9 s | 1.20.124.028/0000 |
| screw terminals | 2 NC | Ag | BA 9 s | 1.20.124.029/0000 |
| screw terminals | 2 NO | Ag | BA 9 s | 1.20.124.030/0000 |
| clamp cage | 1 NC | Ag | BA 9 s | 1.20.125.021/0000 |
| clamp cage | 1 NO | Ag | BA 9 s | 1.20.125.022/0000 |
| clamp cage | 1 NC, 1 NC | Ag | BA 9 s | 1.20.125.023/0000 |
| clamp cage | 1 NO , 1 NO | Ag | BA 9 s | 1.20.125.024/0000 |
| clamp cage | 1 NO , 1 NC | Ag | BA 9 s | 1.20.125.025/0000 |

Technical data see page 2 - 138

Accessories:

- Filament lamp, BA 9s base (MBC/MCC), 12 - 15 V: **1.90.060.132/0000**
- Filament lamp, BA 9s base (MBC/MCC), 24 - 30 V: **1.90.060.133/0000**
- Filament lamp, BA 9s base (MBC/MCC), 110 - 130 V: **1.90.060.137/0000**
- LED BA 9s (MBC/MCC) superbright, red, 24 V: **1.90.690.341/0000**
- LED BA 9s (MBC/MCC) superbright, green, 24 V: **1.90.690.342/0000**
- LED BA 9s (MBC/MCC) superbright, yellow, 24 V: **1.90.690.343/0000**
- LED BA 9s (MBC/MCC) superbright, blue, 24 V: **1.90.690.344/0000**
- LED BA 9s (MBC/MCC) superbright, white, 24 V: **1.90.690.345/0000**

Contact arrangement example (1 NO = 1 normally open contact, 1 NC = 1 normally closed contact)

 1 NO, 1 NC = **Two separate contact blocks** are mounted on the coupling: One with a normally open contact and one with a normally closed contact

 1 NC + 1 NO = **One contact block with double contacts** (1 normally closed and 1 normally open) is mounted on the coupling.

BA 9s (MBC/MCC) = Lamp socket snaps onto coupling centre.

RAFIX 22 QR contact blocks with gold contacts, screw terminals and cage clamp terminals



Pict.: Au contacts, 1 NC, screw terminals

Au contacts, 1 NO, cage clamp terminals

Assembly: Au contacts, 1NC + 1NO

General data

Most of the values specified apply to both screw terminal and cage clamp terminal versions. Any deviating values specific to the cage clamp version are given in parentheses ().

Technical data

Dimensions

| | |
|------------------------------|---------|
| Length | 39.5 mm |
| Width | 10 mm |
| Height | 46 mm |
| Mounting depth without cable | 56.4 mm |

Mechanical design

| | |
|--|-----------------------------------|
| Mounting | snap on coupling and actuator |
| Contact system | bridgecontact self cleaning |
| Contact materials | Au |
| Contact arrangement | see order block |
| NC contact forcibly actuated acc. to IEC 60947-5-1 | yes |
| Terminals | see order block |
| Terminal marking | colour encoded |
| Robustness | 100 N |
| Operating force | approx. 5 N for 1 contact element |

| | |
|--|----------------------------------|
| Wire range solid wires without wire end sleeves | 2 x 0.75 ... 2.5 mm ² |
| Wire range stranded wires without wire end sleeves | 2 x 1.0 ... 1.5 mm ² |

| | |
|----------------------------------|----------------------------------|
| Wire range with wire end sleeves | 2 x 0.75 ... 1.5 mm ² |
|----------------------------------|----------------------------------|

Electrical characteristics

| | |
|-------------------------|-----------------|
| Operating voltage AC/DC | 1 ... 42 V |
| Operating current AC/DC | 0.01 ... 100 mA |

Lamp characteristics

| | |
|-------------|--------|
| Lamp socket | BA 9 s |
|-------------|--------|

Other specifications

| | |
|--|--|
| Operating life | 1 million at 10 mA/ 24 V DC |
| Switching reliability at 24V/5mA DC | 10 x 10 ⁻⁶ |
| Robustness | acc. IEC 60947-5-5 |
| Corresponding to CE | acc. EU-guideline N 72/73 |
| Shock resistance acc. to IEC 60068-2-27 | 50 g at 11 ms, amplitude half sinusoidal |
| Resistance to vibrations acc. to IEC 60068-2-6 | 10 g at 40 ... 500 Hz |
| Ambient temp. operating min. | -25 °C |
| Ambient temp. operating max. | +70 °C |
| Storage temperature min. | -40 °C |
| Storage temperature max. | +80 °C |
| Resistance to constant environment | IEC 600 68-2-3 and 2-30 |
| Resistance at variable environment | IEC 600 68-2-14 and 2-33 |

Accessories RAFIX 22 QR contact blocks with gold contacts, screw terminals and cage clamp terminals

| Description | Photo | Order no. | Page |
|--|-------|--------------------------|---------|
| Filament lamp, BA 9s base (MBC/MCC), 24 - 30 V | | 1.90.060.133/0000 | 5 - 8 |
| Neon lamp BA 9s (MBC/MCC), 220 V AC (red) | | 1.90.560.102/0000 | 5 - 9 |
| LED BA 9s (MBC/MCC) superbright, white, 24 V | | 1.90.690.345/0000 | 5 - 20 |
| Marking tag for contact blocks/lamp sockets with screw terminals | | 5.40.010.131/0000 | 2 - 160 |

RAFIX 22 QR contact block with gold contacts

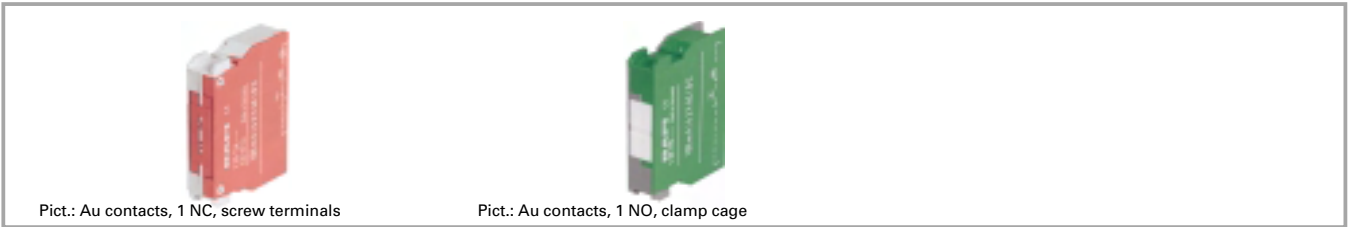

| Terminals | Contact arrangement | Contact materials | Lamp socket | Order no. complete |
|-----------------|---------------------|-------------------|-------------|--------------------------|
| screw terminals | 2 NC | Au | | 5.00.100.161/0000 |
| screw terminals | 2 NO | Au | | 5.00.100.162/0000 |
| screw terminals | 1 NC + 1 NO | Au | | 5.00.100.163/0000 |
| screw terminals | 1 NC | Au | | 5.00.100.164/0000 |
| screw terminals | 1 NO | Au | | 5.00.100.165/0000 |
| clamp cage | 1 NC | Au | | 5.00.100.159/0000 |
| clamp cage | 1 NO | Au | | 5.00.100.160/0000 |

Technical data see page 2 - 142

2

RAFIX
22 QR

onlinecomponents.com

RAFIX 22 QR contact block assembly, with coupling, without lamp socket, gold contacts

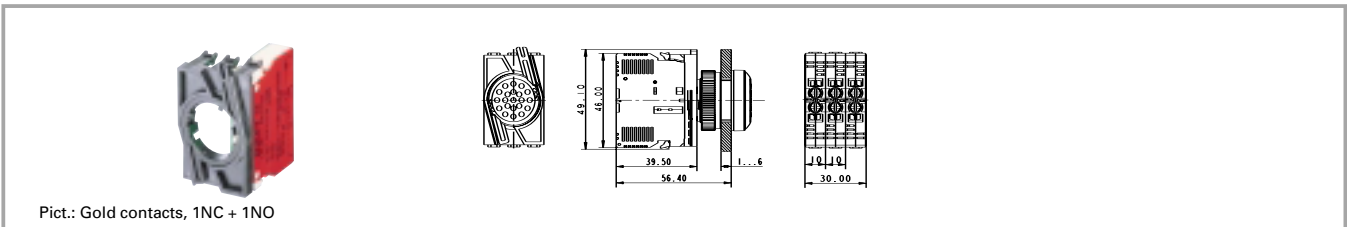

| Terminals | Contact arrangement | Contact materials | Lamp socket | Order no. complete |
|-----------------|------------------------------|-------------------|-------------|--------------------|
| screw terminals | 1 NC | Au | | 1.20.124.101/0000 |
| screw terminals | 1 NO | Au | | 1.20.124.102/0000 |
| screw terminals | 1 NC, 1 NC | Au | | 1.20.124.103/0000 |
| screw terminals | 1 NO , 1 NO | Au | | 1.20.124.104/0000 |
| screw terminals | 1 NO , 1 NC | Au | | 1.20.124.105/0000 |
| screw terminals | 1 NC + 1 NO | Au | | 1.20.124.117/0000 |
| screw terminals | 1 NC + 1 NO , 1 NC + 1 NO | Au | | 1.20.124.118/0000 |
| screw terminals | 2 NC | Au | | 1.20.124.119/0000 |
| screw terminals | 2 NO | Au | | 1.20.124.120/0000 |
| clamp cage | 1 NC | Au | | 1.20.125.101/0000 |
| clamp cage | 1 NO | Au | | 1.20.125.102/0000 |
| clamp cage | 1 NC, 1 NC | Au | | 1.20.125.103/0000 |
| clamp cage | 1 NO , 1 NO | Au | | 1.20.125.104/0000 |
| clamp cage | 1 NO , 1 NC | Au | | 1.20.125.105/0000 |

Technical data see page 2 - 142

Contact arrangement example (1 NO = 1 normally open contact, 1 NC = 1 normally closed contact)

1 NO, 1 NC = **Two separate contact blocks** are mounted on the coupling: One with a normally open contact and one with a normally closed contact

1 NC + 1 NO = **One contact block with double contacts** (1 normally closed and 1 normally open) is mounted on the coupling.

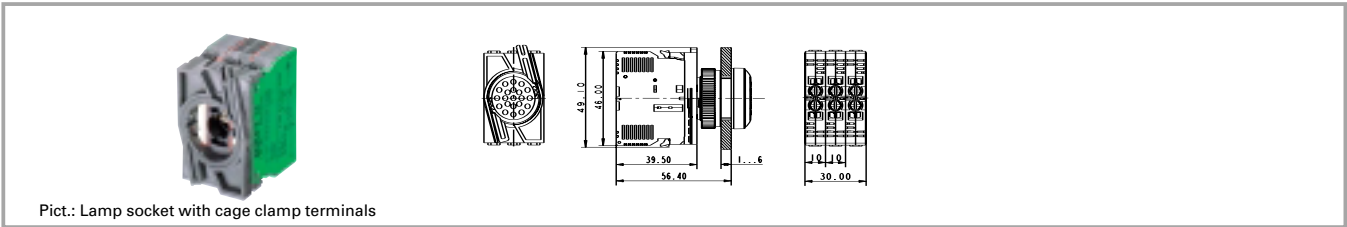
RAFIX 22 QR contact block assembly, with coupling and lamp socket, gold contacts

Pict.: Lamp socket with cage clamp terminals

| Terminals | Contact arrangement | Contact materials | Lamp socket | Order no. complete |
|-----------------|------------------------------|-------------------|-------------|--------------------|
| screw terminals | 1 NC | Au | BA 9 s | 1.20.124.121/0000 |
| screw terminals | 1 NO | Au | BA 9 s | 1.20.124.122/0000 |
| screw terminals | 1 NC, 1 NC | Au | BA 9 s | 1.20.124.123/0000 |
| screw terminals | 1 NO , 1 NO | Au | BA 9 s | 1.20.124.124/0000 |
| screw terminals | 1 NO , 1 NC | Au | BA 9 s | 1.20.124.125/0000 |
| screw terminals | 1 NC + 1 NO | Au | BA 9 s | 1.20.124.127/0000 |
| screw terminals | 1 NC + 1 NO , 1 NC + 1 NO | Au | BA 9 s | 1.20.124.128/0000 |
| screw terminals | 2 NC | Au | BA 9 s | 1.20.124.129/0000 |
| screw terminals | 2 NO | Au | BA 9 s | 1.20.124.130/0000 |
| clamp cage | 1 NC | Au | BA 9 s | 1.20.125.121/0000 |
| clamp cage | 1 NO | Au | BA 9 s | 1.20.125.122/0000 |
| clamp cage | 1 NC, 1 NC | Au | BA 9 s | 1.20.125.123/0000 |
| clamp cage | 1 NO , 1 NO | Au | BA 9 s | 1.20.125.124/0000 |
| clamp cage | 1 NO , 1 NC | Au | BA 9 s | 1.20.125.125/0000 |

Technical data see page 2 - 142

Accessories:

- Filament lamp, BA 9s base (MBC/MCC), 12 - 15 V: **1.90.060.132/0000**
- Filament lamp, BA 9s base (MBC/MCC), 24 - 30 V: **1.90.060.133/0000**
- Filament lamp, BA 9s base (MBC/MCC), 110 - 130 V: **1.90.060.137/0000**
- LED BA 9s (MBC/MCC) superbright, red, 24 V: **1.90.690.341/0000**
- LED BA 9s (MBC/MCC) superbright, green, 24 V: **1.90.690.342/0000**
- LED BA 9s (MBC/MCC) superbright, yellow, 24 V: **1.90.690.343/0000**
- LED BA 9s (MBC/MCC) superbright, blue, 24 V: **1.90.690.344/0000**
- LED BA 9s (MBC/MCC) superbright, white, 24 V: **1.90.690.345/0000**

Contact arrangement example (1 NO = 1 normally open contact, 1 NC = 1 normally closed contact)

 1 NO, 1 NC = **Two separate contact blocks** are mounted on the coupling: One with a normally open contact and one with a normally closed contact

 1 NC + 1 NO = **One contact block with double contacts** (1 normally closed and 1 normally open) is mounted on the coupling.

BA 9s (MBC/MCC) = Lamp socket snaps onto coupling centre.

RAFIX 22 QR Contact blocks with coupling, gold contacts, RJ 12 connector, integrated LED

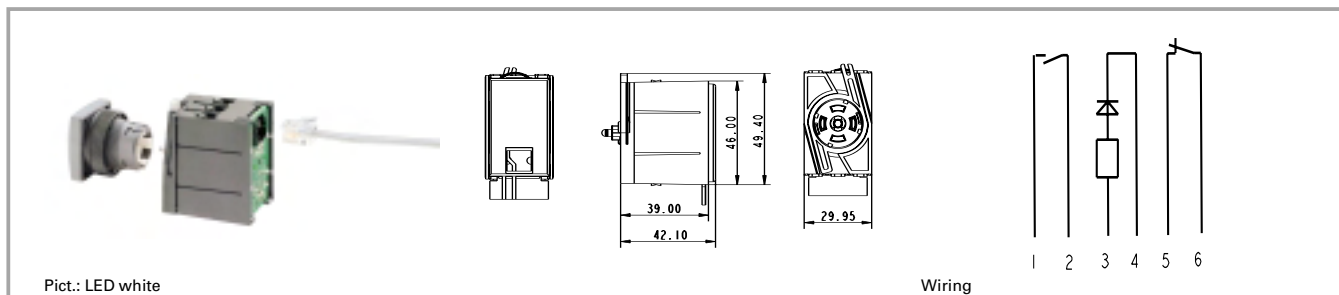

2

Technical data

Dimensions

| | |
|----------------|----------|
| Length | 49.4 mm |
| Width | 29.95 mm |
| Height | 42.1 mm |
| Mounting depth | 62 mm |

Mechanical design

| | |
|----------------|-----------------------------|
| Mounting | snap on actuator |
| Contact system | bridgecontact self cleaning |

| | |
|--|-----------------|
| Contact materials | Au |
| Contact arrangement | see order block |
| NC contact forcibly actuated acc. to IEC 60947-5-1 | yes |
| Terminals | RJ-12 |
| Terminal marking | RJ-12 plug |
| Mounting grid | 30 x 50 |
| Robustness | 100 N |

Electrical characteristics

| | |
|-------------------------|----------------|
| Operating voltage AC/DC | 24 V |
| Operating current AC/DC | 0.01 ... 50 mA |

Other specifications

| | |
|--|--------------------------|
| Operating life | 1000000 at 50 mA/24 V DC |
| Switching reliability at 24V/5mA DC | 10×10^{-6} |
| Ambient temp. operating min. | -25 °C |
| Ambient temp. operating without LED max. | +70 °C |
| Ambient temp. operating with LED max. | +50 °C |
| Storage temperature min. | -30 °C |
| Storage temperature max. | +80 °C |
| Integrated LED | see order block |
| LED colour | see order block |
| Resistance to constant environment | IEC 600 68-2-3 and 2-30 |
| Resistance at variable environment | IEC 600 68-2-14 and 2-33 |

RAFIX
22 QR

RAFIX 22 QR Contact block with coupling, gold contacts, RJ 12 connector, integrated LED

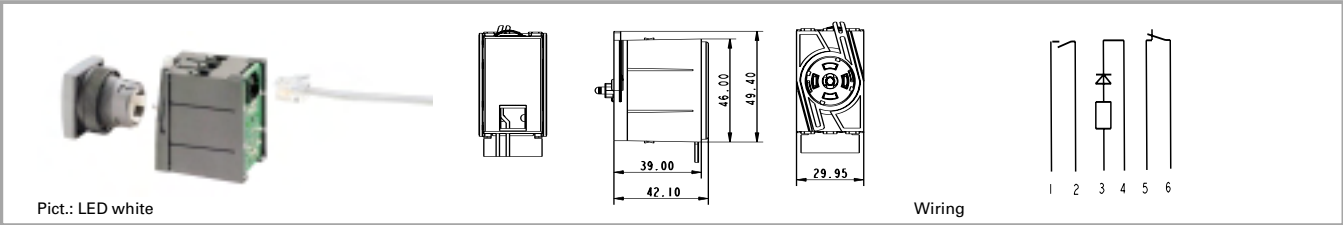

| Contact arrangement | Operating voltage AC/DC | Integrated LED | LED colour | Order no. complete |
|---------------------|-------------------------|----------------|------------|--------------------|
| 1 NC | 24 V | no | | 1.20.128.001/0000 |
| 1 NC | 24 V | yes | white | 1.20.128.011/0000 |
| 1 NC | 24 V | yes | red | 1.20.128.021/0000 |
| 1 NC | 24 V | yes | yellow | 1.20.128.031/0000 |
| 1 NC | 24 V | yes | green | 1.20.128.041/0000 |
| 1 NC | 24 V | yes | blue | 1.20.128.051/0000 |
| 1 NO | 24 V | no | | 1.20.128.002/0000 |
| 1 NO | 24 V | yes | white | 1.20.128.012/0000 |
| 1 NO | 24 V | yes | red | 1.20.128.022/0000 |
| 1 NO | 24 V | yes | yellow | 1.20.128.032/0000 |
| 1 NO | 24 V | yes | green | 1.20.128.042/0000 |
| 1 NO | 24 V | yes | blue | 1.20.128.052/0000 |
| 1 NC + 1 NO | 24 V | no | | 1.20.128.003/0000 |
| 1 NC + 1 NO | 24 V | yes | white | 1.20.128.013/0000 |
| 1 NC + 1 NO | 24 V | yes | red | 1.20.128.023/0000 |
| 1 NC + 1 NO | 24 V | yes | yellow | 1.20.128.033/0000 |
| 1 NC + 1 NO | 24 V | yes | green | 1.20.128.043/0000 |
| 1 NC + 1 NO | 24 V | yes | blue | 1.20.128.053/0000 |

Technical data see page 2 - 146

Other contact arrangement versions available on request.

2

RAFIX 22 QR

RAFIX 22 QR lamp sockets BA 9s (MBC/MCC), screw terminals and cage clamp terminals



2

Technical data

Dimensions

| | |
|------------------------------|---------|
| Length | 46 mm |
| Width | 10 mm |
| Height | 39.5 mm |
| Mounting depth without cable | 56.4 mm |

Mechanical design

| | |
|------------------|-------------------------------|
| Mounting | snap on coupling and actuator |
| Terminals | see order block |
| Terminal marking | X1 = anode, X2 = cathode |

Kennwerte Lampenfassung

| | |
|-------------------------|-----------------|
| Lamp socket | BA 9 s |
| Operating voltage AC/DC | see order block |
| Lamp power max. | 2 W |
| Lamp voltage | see order block |

Other specifications

| | |
|--|--|
| Approvals | see order block |
| Robustness | acc. IEC 60947-5-5 |
| Shock resistance acc. to IEC 60068-2-27 | 50 g at 11 ms, amplitude half sinusoidal |
| Resistance to vibrations acc. to IEC 60068-2-6 | 10 g at 40 ... 500 Hz |
| Resistance to constant environment | IEC 600 68-2-3 and 2-30 |
| Resistance at variable environment | IEC 600 68-2-14 and 2-33 |
| Ambient temp. operating min. | -25 °C |
| Ambient temp. operating max. | +70 °C |
| Storage temperature min. | -40 °C |
| Storage temperature max. | +80 °C |
| Flame class acc. to UL 94 | V 0 |
| Hot wire ignition acc. to IEC 60695-2-1 | yes |

RAFIX 22 QR

Accessories RAFIX 22 QR lamp sockets BA 9s (MBC/MCC), screw terminals and cage clamp terminals

| Description | Photo | Order no. | Page |
|--|-------|--------------------------|--------|
| Filament lamp, BA 9s base (MBC/MCC), 12 - 15 V | | 1.90.060.132/0000 | 5 - 8 |
| Filament lamp, BA 9s base (MBC/MCC), 24 - 30 V | | 1.90.060.133/0000 | 5 - 8 |
| Filament lamp, BA 9s base (MBC/MCC), 110 - 130 V | | 1.90.060.137/0000 | 5 - 8 |
| Neon lamp BA 9s (MBC/MCC), 220 V AC (red) | | 1.90.560.102/0000 | 5 - 9 |
| LED BA 9s (MBC/MCC) superbright, red, 24 V | | 1.90.690.341/0000 | 5 - 20 |
| LED BA 9s (MBC/MCC) superbright, green, 24 V | | 1.90.690.342/0000 | 5 - 20 |
| LED BA 9s (MBC/MCC) superbright, yellow, 24 V | | 1.90.690.343/0000 | 5 - 20 |

Accessories RAFIX 22 QR lamp sockets BA 9s (MBC/MCC), screw terminals and cage clamp terminals

| Description | Photo | Order no. | Page |
|--|-------|--------------------------|---------|
| LED BA 9s (MBC/MCC) superbright, blue, 24 V | | 1.90.690.344/0000 | 5 - 20 |
| LED BA 9s (MBC/MCC) superbright, white, 24 V | | 1.90.690.345/0000 | 5 - 20 |
| Coupling with reference numbers 1-3-2 | | 5.05.510.935/0000 | 2 - 158 |
| Coupling with reference numbers 1/2-5/6-3/4 | | 5.05.510.936/0000 | 2 - 158 |
| Marking tag for contact blocks/lamp sockets with screw terminals | | 5.40.010.131/0000 | 2 - 160 |

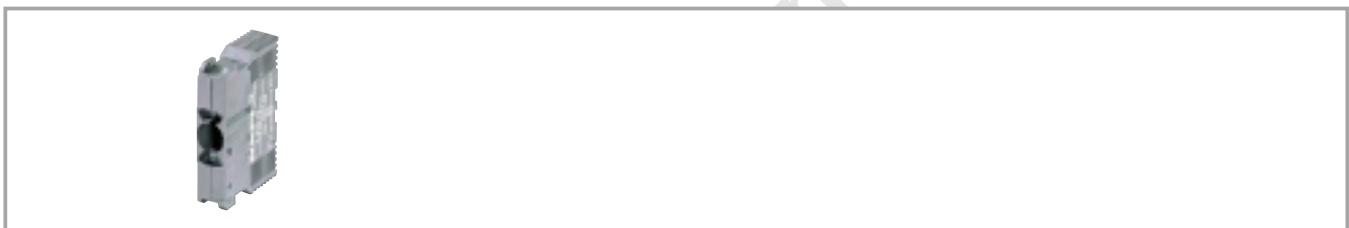
2
RAFIX 22 QR lamp socket, without coupling

**RAFIX
22 QR**

| Terminals | Diode and resistor | Approvals | Lamp socket | Operating voltage AC/DC | Lamp voltage | Order no. complete |
|-----------------|--------------------|-----------------|--------------|-------------------------|--------------|--------------------------|
| screw terminals | no | ENEC 10/15; ULc | BA 9 s | 6 ... 250 V | 6 ... 250 V | 5.00.070.074/0000 |
| screw terminals | yes | ENEC 10/15; ULc | BA 9 s | 250 V | 130 V | 5.00.070.080/0000 |
| clamp cage | no | ENEC 10/15; ULc | BA 9 sBA 9 s | 6 ... 250 V | 6 ... 250 V | 5.00.070.078/0000 |

Technical data see page 2 - 148

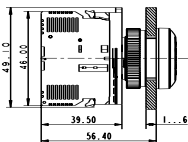
RAFIX 22 QR lamp socket assembly, with coupling



Pict.: Lamp socket with cage clamp terminals

| Terminals | Diode and resistor | Approvals | Lamp socket | Operating voltage AC/DC | Lamp voltage | Order no. complete |
|-----------------|--------------------|--------------------|--------------|-------------------------|--------------|--------------------------|
| screw terminals | no | ENEC 10/15; ULc | BA 9 s | 6 ... 250 V | 6 ... 250 V | 1.71.213.001/0000 |
| screw terminals | yes | ENEC 10/15; ULc | BA 9 s | 250 V | 130 V | 1.71.213.004/0000 |
| clamp cage | no | ENEC 10/15; ULc | BA 9 sBA 9 s | 6 ... 250 V | 6 ... 250 V | 1.71.214.001/0000 |

Technical data see page 2 - 148

2

RAFIX
22 QR

onlinecomponents.com

RAFIX 22 QR lamp sockets with integrated LED, screw terminals



2

Technical data

Dimensions

| | |
|------------------------------|---------|
| Length | 46 mm |
| Width | 10 mm |
| Height | 39.5 mm |
| Mounting depth without cable | 56.4 mm |

Mechanical design

| | |
|--------------------|-------------------------------|
| Mounting | snap on coupling and actuator |
| Diode and resistor | see order block |
| LED colour | see order block |
| Terminals | screw terminals |
| Terminal marking | X1 = anode, X2 = cathode |

Lamp characteristics

| | |
|------------------------------|-----------------|
| Operating voltage | see order block |
| Max. current, I _F | see order block |

Other specifications

| | |
|--|--|
| Approvals | ENEC 10/15; ULc |
| Robustness | acc. IEC 60947-5-5 |
| Shock resistance acc. to IEC 60068-2-27 | 50 g at 11 ms, amplitude half sinusoidal |
| Resistance to vibrations acc. to IEC 60068-2-6 | 10 g at 40 ... 500 Hz |
| Resistance to constant environment | IEC 600 68-2-3 and 2-30 |
| Resistance at variable environment | IEC 600 68-2-14 and 2-33 |
| Ambient temp. operating min. | -20 °C |
| Ambient temp. operating max. | +65 °C |
| Storage temperature min. | -40 °C |
| Storage temperature max. | +80 °C |
| Flame class acc. to UL 94 | V 0 |
| Hot wire ignition acc. to IEC 60695-2-1 | yes |

RAFIX 22 QR

Accessories RAFIX 22 QR lamp sockets with integrated LED, screw terminals

| Description | Photo | Order no. | Page |
|--|-------|--------------------------|---------|
| Coupling with reference numbers 1-3-2 | | 5.05.510.935/0000 | 2 - 158 |
| Coupling with reference numbers 1/2-5/6-3/4 | | 5.05.510.936/0000 | 2 - 158 |
| Marking tag for contact blocks/lamp sockets with screw terminals | | 5.40.010.131/0000 | 2 - 160 |

RAFIX 22 QR lamp socket with integrated red LED, without coupling



| Terminals | Diode and resistor | LED colour | Max. current, I _F | Operating voltage | Order no. complete |
|-----------------|--------------------|------------|------------------------------|-------------------|--------------------|
| screw terminals | | white | 15 mA | AC/DC 24 V | 5.00.070.083/0200 |
| screw terminals | | red | 15 mA | AC/DC 24 V | 5.00.070.083/0300 |
| screw terminals | | yellow | 15 mA | AC/DC 24 V | 5.00.070.083/0400 |
| screw terminals | | green | 15 mA | AC/DC 24 V | 5.00.070.083/0500 |
| screw terminals | | blue | 15 mA | AC/DC 24 V | 5.00.070.083/0600 |
| screw terminals | | white | 16 mA | AC 115 V | 5.00.070.085/0200 |
| screw terminals | | red | 16 mA | AC 115 V | 5.00.070.085/0300 |
| screw terminals | | yellow | 16 mA | AC 115 V | 5.00.070.085/0400 |
| screw terminals | | green | 16 mA | AC 115 V | 5.00.070.085/0500 |
| screw terminals | | blue | 16 mA | AC 115 V | 5.00.070.085/0600 |
| screw terminals | | white | 16 mA | AC 230 V | 5.00.070.086/0200 |
| screw terminals | | red | 16 mA | AC 230 V | 5.00.070.086/0300 |
| screw terminals | | yellow | 16 mA | AC 230 V | 5.00.070.086/0400 |
| screw terminals | | green | 16 mA | AC 230 V | 5.00.070.086/0500 |
| screw terminals | | blue | 16 mA | AC 230 V | 5.00.070.086/0600 |

Technical data see page 2 - 152

2

RAFIX
22 QR

RAFIX 22 QR special accessories



2

Accessories RAFIX 22 QR special accessories

| Description | Photo | Order no. | Page |
|--|--|--------------------------|--------|
| Fixing spanner for ring nut and front ring |  | 5.05.800.062/0000 | 5 - 25 |

Housings for flush pushbuttons



| Short text | Feature 1 | Feature 2 | Order no. |
|--|-----------|-----------|-------------------|
| Housings for pushbuttons, round collar, flush lens, momentary | | | 1.30.240.601/0000 |
| Housings for pushbuttons, square collar, flush lens, momentary | | | 1.30.240.602/0000 |

RAFIX
22 QR

Lenses for flush pushbuttons



| Short text | Feature 1 | Feature 2 | Order no. |
|---------------------|------------------------|-----------|-------------------|
| Lens, with diffuser | transparent colourless | flat lens | 5.04.926.008/1000 |
| Lens, with diffuser | transparent red | flat lens | 5.04.926.008/1300 |
| Lens, with diffuser | transparent yellow | flat lens | 5.04.926.008/1400 |
| Lens, with diffuser | transparent green | flat lens | 5.04.926.008/1500 |
| Lens, with diffuser | transparent blue | flat lens | 5.04.926.008/1600 |
| Lens | opaque black | flat lens | 5.49.263.019/0100 |
| Lens | opaque white | flat lens | 5.49.263.019/0200 |
| Lens | opaque red | flat lens | 5.49.263.019/0300 |
| Lens | opaque yellow | flat lens | 5.49.263.019/0400 |
| Lens | opaque green | flat lens | 5.49.263.019/0500 |
| Lens | opaque blue | flat lens | 5.49.263.014/0600 |
| Lens | opaque slate-grey | flat lens | 5.49.263.019/0700 |

2

RAFIX
22 QR

Front ring



Pict.: metal

| Short text | Feature 1 | Feature 2 | Order no. |
|----------------------------------|-----------|-----------|-------------------|
| Front ring, metal | | | 5.45.638.015/6030 |
| Front ring, plastic, black | | | 5.45.639.020/0100 |
| Front ring, plastic, red | | | 5.45.639.020/0300 |
| Front ring, plastic, yellow | | | 5.45.639.020/0400 |
| Front ring, plastic, green | | | 5.45.639.020/0500 |
| Front ring, plastic, blue | | | 5.45.639.020/0600 |
| Front ring, plastic, slate grey | | | 5.45.639.020/0700 |
| Front ring, plastic, silver grey | | | 5.45.639.020/0800 |

RAFIX 22 QR plastic front ring with protective cap



Pict.: slate-grey

| Short text | Feature 1 | Feature 2 | Order no. |
|---|-------------|-----------|-------------------|
| Front ring, plastic with thermoflex protective cap, slate grey | slate-grey | | 5.05.004.914/0700 |
| Front ring, plastic with thermoflex protective cap, silver grey | silver-grey | | 5.05.004.914/0800 |

Label holder

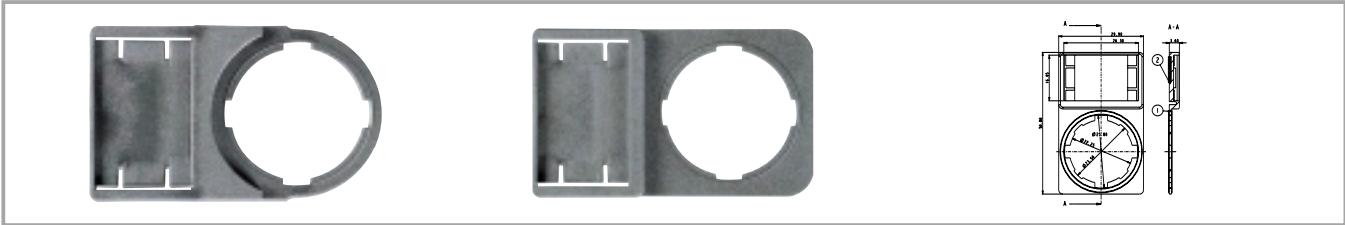

| Short text | Feature 1 | Feature 2 | Order no. |
|---|-----------|-----------|-------------------|
| Label holder, round collar, with adhesive tape and release liner on back | | | 5.07.620.010/0000 |
| Label holder, square collar, with adhesive tape and release liner on back | | | 5.07.620.011/0000 |

2

Legend label to clip into label holder 5.07.620.xxx



RAFIX
22 QR

| Short text | Feature 1 | Feature 2 | Order no. |
|--|-----------|-----------|-------------------|
| Label for label holder, without legend, 16 x 28 x 0.9 mm | | | 5.73.110.000/0000 |

Legending available on request.

Coupling



| Short text | Feature 1 | Feature 2 | Order no. |
|--|-----------|-----------|--------------------------|
| Coupling with reference numbers 1-3-2, for contact blocks with single contacts | | | 5.05.510.935/0000 |
| Coupling with reference numbers 1/2-5/6-3/4, for contact blocks with double contacts | | | 5.05.510.936/0000 |

Blanking cap

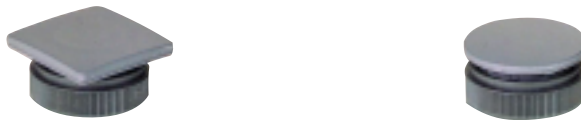

| Short text | Feature 1 | Feature 2 | Order no. |
|-------------------------------------|-----------|-----------|--------------------------|
| Blanking cap IP65, ring nut, square | | | 5.05.800.065/0000 |
| Blanking cap IP65, ring nut, round | | | 5.05.800.064/0000 |

2

RAFIX
22 QR

Ring nut



| Short text | Feature 1 | Feature 2 | Order no. |
|---------------------------------|-----------|-----------|-------------------|
| Ring nut (spare part) | | | 5.24.279.012/0100 |
| Ring nut with claw (spare part) | | | 5.02.420.001/0000 |

2

Lamp tester



| Short text | Feature 1 | Feature 2 | Order no. |
|-------------|-----------|-----------|-------------------|
| Lamp tester | | | 5.03.771.678/0000 |

RAFIX
22 QR

Protective cover, suitable for pushbuttons with flush lens



| Short text | Feature 1 | Feature 2 | Order no. |
|--------------------------------|--------------|-----------|-------------------|
| Protective cover, latching | latching | | 5.05.511.195/0000 |
| Protective cover, auto-closing | auto-closing | | 5.05.511.194/0000 |

Marking tag



| Short text | Feature 1 | Feature 2 | Order no. |
|--|-----------|-----------|-------------------|
| Marking tag for contact blocks/lamp sockets with screw terminals | | | 5.40.010.131/0000 |

Insulating housing IP65 for RAFX 22 QR



Pict.: 3-module

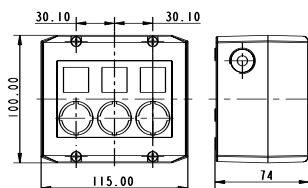

| Short text | Feature 1 | Feature 2 | Order no. |
|---|-----------|-----------|--------------------------|
| Insulating housing IP65 for 22 QR, 1-module, light grey/dark grey | 100 mm | 55 mm | 1.20.810.201/0000 |
| Insulating housing IP65 for 22 QR, 1-module, yellow/yellow | 100 mm | 55 mm | 1.20.810.202/0000 |
| Insulating housing IP65 for 22 QR, 2-module, light grey/dark grey | 100 mm | 115 mm | 1.20.820.201/0000 |
| Insulating housing IP65 for 22 QR, 3-module, light grey/dark grey | 100 mm | 115 mm | 1.20.830.201/0000 |
| Insulating housing IP65 for 22 QR, 4-module, light grey/dark grey | 100 mm | 145 mm | 1.20.840.201/0000 |

Accessories:

Label sheet for housings: 5.40.451.283/0000

- Attractive plastic housing to accommodate up to 4 control components
- 2 cable entries prepared: 1-,2-,3-part: M20x1,5, 4-part: M25x1,5
- Degree of protection IP 65 to DIN
- All grey housings with overlay, legending possible with legend inserts
- Wall mounting with 2 screws through housing bottom prepared
- Dimensions: (feature 2) x 100 mm x 74 mm
- Accessories: 50 pre-perforated legend inserts on a DIN A4 sheet for printing with a PC printer

Emergency stop label plate

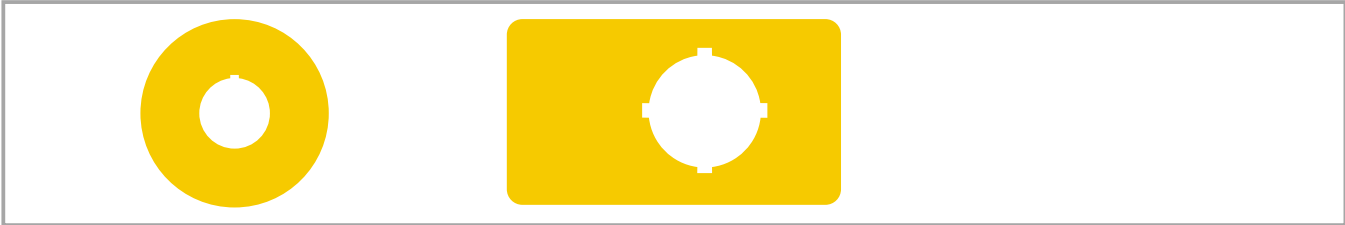

| Short text | Feature 1 | Feature 2 | Order no. |
|--|-----------|-----------|-------------------|
| Emergency stop label, yellow, round 60 mm, rigid PVC, with legend "NOT-AUS" | | 60 mm | 5.76.207.001/0400 |
| Emergency stop label, yellow, round 60 mm, rigid PVC, with legend "EMERGENCY-STOP/ARRET D'URGENCE" | | 60 mm | 5.76.207.002/0400 |
| Emergency stop label, yellow, round 60 mm, PVC adhesive, without legend | | 60 mm | 5.76.204.100/0400 |
| Emergency stop label, yellow, round 60 mm, PVC adhesive, with legend "NOT-AUS" | | 60 mm | 5.76.204.101/0400 |
| Emergency stop label, yellow, round 60 mm, PVC adhesive, with legend "ARRET D'URGENCE" | | 60 mm | 5.76.204.102/0400 |
| Emergency stop label, yellow, round 60 mm, PVC adhesive, with legend "EMERGENCY-STOP" | | 60 mm | 5.76.204.103/0400 |
| Emergency stop label, yellow 36 x 64 mm, PVC adhesive, without legend | 64 mm | 36 mm | 5.76.205.011/0400 |

Degree of protection: Rigid PVC: IP 40, adhesive foil: IP65.

2

RAFIX
22 QR

onlinecomponents.com