

## Identification

Type Designation	<b>LR3 48-3/115</b>	Type of reactor	<b>3~ Line Reactor</b>
Series	<b>LR3</b>	Core Rating	<b>2886.72 var</b>
Core type	<b>3UI 114/64</b>	Drive HP	<b>75</b>

## Technical Data

No. of phase		<b>3</b>
Circuit type		<b>III0</b>
Rated Voltage	[ V ]	<b>480</b>
Rated current	[ A ]	<b>115.0</b>
Rated Frequency	[ Hz ]	<b>50 - 60</b>
Impedance	[ % ]	<b>3.0</b>
Inductance L	[ mH ]	<b>0.193</b>
L tolerance	[ % ]	<b>±10%</b>
Linearity		<b>137% In</b>
Losses (typical)	[ W ]	<b>150.26</b>
Test voltage	[ kV ]	<b>4.0</b>
Isolation System Class		<b>class 155</b>

## Operating conditions

Ambient temperature	[ °C ]	<b>-10 ... +40°C</b>
Ambient temperature	[ F ]	<b>14 ... 104°F</b>
Type of cooling		<b>AN</b>
Operating conditions		<b>24/7</b>

## Standards

Type:	Signs
VDE 0570 / EN 61 558 Part 1 VDE 0570 / EN 61 558 Part 20	

## Approvals

UL 508		E219022	NMTR
UL 5085-1		E103521	XPTQ

**Product Ident**  
LR3 48-3/115

# Line-Reactor Datasheet



Variations may apply due to material's and production's tolerances. Objected to modifications without notice.

## Dimensions / Mounting in Inches

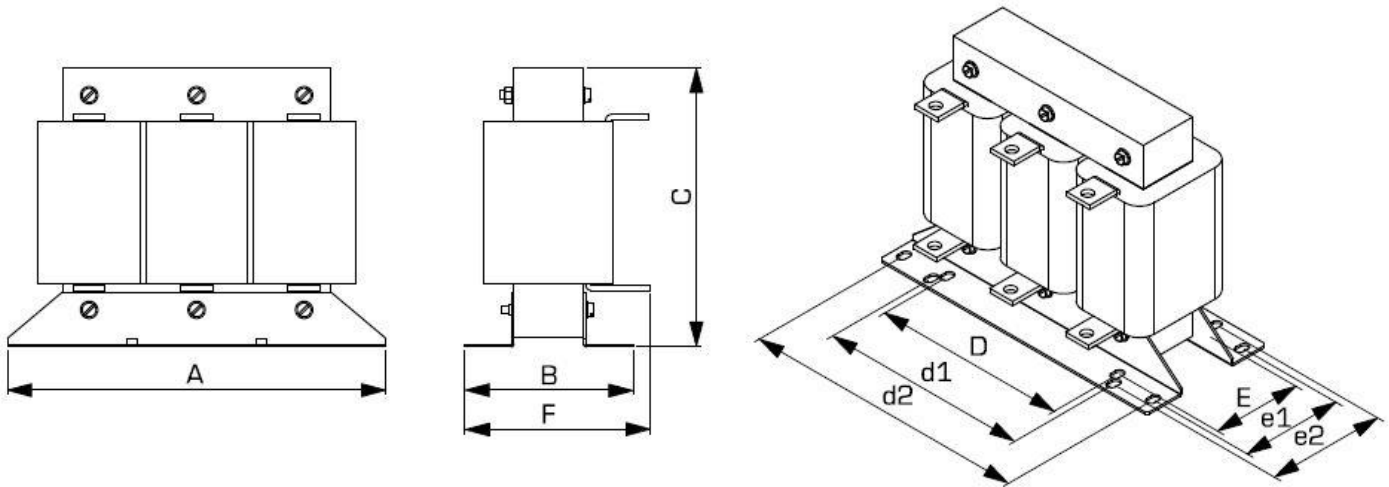

A	B	C*	F	D	d1	d2	E	e1	e2	Drill
10.51	5.98	7.91	-	6.93	7.09	9.80	3.86	4.80	4.20	0.28
										0.28
										0.28

\* = Typical variable air gab

## Weight

Weight	[ kg ]	<b>21.38</b>
	[ lbs ]	<b>47.13</b>

## Notes

Technical specifications in the drawing are not binding. General tolerance to DIN 7168-m. Subject to change.  
Mounting plates also available in stainless steel as OEM application. Ask for details.

Original Date:	15/04/20	Observe protection clause to ISO 16016	Index	0
Name:	Lüning		Doc. type	
Date:	15/05/06			
Checked:	Wesner		Pages	2 of 2