

# GRM3195C1H122JA01#

"#" indicates a package specification code.

Available   Complies with RoHS

< List of part numbers with package codes >  
GRM3195C1H122JA01D , GRM3195C1H122JA01J

## Shape

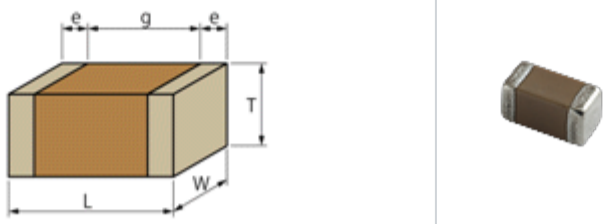
	
L size	3.2 ± 0.15mm
W size	1.6 ± 0.15mm
T size	0.85 ± 0.1mm
External terminal width e	0.3 to 0.8mm
Distance between external terminals g	1.5mm min.
Size code in inch(mm)	1206 (3216)

## References

Packaging	Specifications	Minimum quantity
D	180mm Paper taping	4000
J	330mm Paper taping	10000

Mass (typ.)	
1 piece	19mg
180mm Reel	191g

## Specifications

Capacitance	1200pF ± 5%
Rated voltage	50Vdc
Temperature characteristics (complied standard)	COG(EIA)
Temperature coefficient	0 ± 30ppm/
Temperature range of temperature characteristics	25 to 125
Operating temperature range	-55 to 125

### Attention

- 1.This datasheet is downloaded from the website of Murata Manufacturing Co., Ltd. Therefore, it ' s specifications are subject to change or our products in it may be discontinued without advance notice. Please check with our sales representatives or product engineers before ordering.
- 2.This datasheet has only typical specifications because there is no space for detailed specifications. Therefore, please review our product specifications or consult the approval sheet for product specifications before ordering.