

January 1998

Features

- -0.6A and -0.7A, -80V and -100V
- $r_{DS(ON)} = 1.2\Omega$ and 1.6Ω
- Single Pulse Avalanche Energy Rated
- SOA is Power Dissipation Limited
- Nanosecond Switching Speeds
- Linear Transfer Characteristics
- High Input Impedance
- Related Literature
 - TB334, "Guidelines for Soldering Surface Mount Components to PC Boards"

Ordering Information

PART NUMBER	PACKAGE	BRAND
IRFD9110	HEXDIP	IRFD9110
IRFD9113	HEXDIP	IRFD9113

NOTE: When ordering, use the entire part number.

Description

These are P-Channel enhancement mode silicon gate power field effect transistors. They are advanced power MOSFETs designed, tested, and guaranteed to withstand a specified level of energy in the breakdown avalanche mode of operation. All of these power MOSFETs are designed for applications such as switching regulators, switching converters, motor drivers, relay drivers, and drivers for high power bipolar switching transistors requiring high speed and low gate drive power. These types can be operated directly from integrated circuits.

Formerly developmental type TA17541.

Symbol

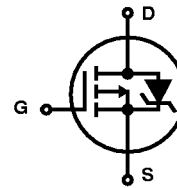

Packaging

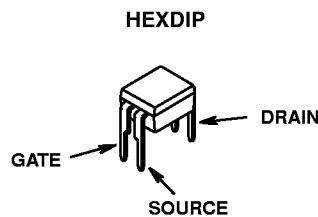

IRFD9110, IRFD9113

Absolute Maximum Ratings $T_C = 25^\circ\text{C}$, Unless Otherwise Specified

	IRFD9110	IRFD9113	UNITS
Drain to Source Breakdown Voltage (Note 1)	V_{DS} -100	-80	V
Drain to Gate Voltage ($R_{GS} = 20k\Omega$) (Note 1)	V_{DGR} -100	-80	V
Continuous Drain Current	I_D -0.7	-0.6	A
Pulsed Drain Current	I_{DM} -3.0	-2.5	A
Gate to Source Voltage	V_{GS} ± 20	± 20	V
Maximum Power Dissipation (Figure 1)	P_D 1.0	1.0	W
Dissipation Derating Factor (Figure 1)	0.008	0.008	$W/^\circ\text{C}$
Single Pulse Avalanche Energy Rating (Note 3)	E_{AS} 190	190	mJ
Operating and Storage Temperature	T_J, T_{STG} -55 to 150	-55 to 150	$^\circ\text{C}$
Maximum Temperature for Soldering			
Leads at 0.063in (1.6mm) from Case for 10s	T_L 300	300	$^\circ\text{C}$
Package Body for 10s, See Techbrief 334	T_{pkg} 260	260	$^\circ\text{C}$

CAUTION: Stresses above those listed in "Absolute Maximum Ratings" may cause permanent damage to the device. This is a stress only rating and operation of the device at these or any other conditions above those indicated in the operational sections of this specification is not implied.

NOTE:

- $T_J = 25^\circ\text{C}$ to 125°C .

Electrical Specifications $T_C = 25^\circ\text{C}$, Unless Otherwise Specified

PARAMETER	SYMBOL	TEST CONDITIONS	MIN	TYP	MAX	UNITS
Drain to Source Breakdown Voltage IRFD9110	BV_{DSS}	$I_D = -250\mu\text{A}, V_{GS} = 0\text{V}$, (Figure 9)	-100	-	-	V
			IRFD9113	-80	-	-
Gate Threshold Voltage	$V_{GS(TH)}$	$V_{GS} = V_{DS}, I_D = -250\mu\text{A}$	-2	-	-4	V
Zero Gate Voltage Drain Current	I_{DSS}	$V_{DS} = \text{Rated } BV_{DSS}, V_{GS} = 0\text{V}$	-	-	-25	μA
		$V_{DS} = 0.8 \times \text{Rated } BV_{DSS}, V_{GS} = 0\text{V}, T_C = 125^\circ\text{C}$	-	-	-250	μA
On-State Drain Current (Note 2) IRFD9110	$I_{D(ON)}$	$V_{DS} > I_{D(ON)} \times r_{DS(ON)MAX}, V_{GS} = -10\text{V}$, (Figure 6)	-0.7	-	-	A
			IRFD9113	-0.6	-	-
Gate to Source Leakage Current	I_{GSS}	$V_{GS} = \pm 20\text{V}$	-	-	± 100	nA
Drain to Source On Resistance (Note 2) IRFD9110	$r_{DS(ON)}$	$I_D = -0.3\text{A}, V_{GS} = -10\text{V}$, (Figures 8)	-	1.0	1.2	Ω
			IRFD9113	-	1.2	1.6
Forward Transconductance (Note 2)	g_{fs}	$V_{DS} \leq 50\text{V}, I_D = -0.6\text{A}$, (Figure 11)	0.59	0.88	-	S
Turn-On Delay Time	$t_{d(ON)}$	$V_{DD} = 0.5 \times \text{Rated } BV_{DSS}, I_D = -0.7\text{A}, R_G = 9.1\Omega,$ $V_{GS} = -10\text{V}$, (Figures 16, 17), $R_L = 70\Omega$ for $V_{DSS} = 50\text{V}$ $R_L = 56\Omega$ for $V_{DSS} = 40\text{V}$ MOSFET Switching Times are Essentially Independent of Operating Temperature	-	15	30	ns
Rise Time	t_r		-	30	60	ns
Turn-Off Delay Time	$t_{d(OFF)}$		-	20	40	ns
Fall Time	t_f		-	20	40	ns
Total Gate Charge (Gate to Source + Gate to Drain)	$Q_{g(TOT)}$	$V_{GS} = -10\text{V}, I_D = -0.7\text{A}, V_{DS} = 0.8\text{V} \times \text{Rated } BV_{DSS}$, (Figures 13, 18, 19) Gate Charge is Essentially Independent of Operating Temperature	-	11	15	nC
Gate to Source Charge	Q_{gs}		-	5.7	-	nC
Gate to Drain "Miller" Charge	Q_{gd}		-	5.3	-	nC
Input Capacitance	C_{ISS}	$V_{DS} = -25\text{V}, V_{GS} = 0\text{V}, f = 1\text{MHz}$, (Figure 10)	-	180	-	pF
Output Capacitance	C_{OSS}		-	85	-	pF
Reverse Transfer Capacitance	C_{RSS}		-	30	-	pF

IRFD9110, IRFD9113

Electrical Specifications $T_C = 25^\circ\text{C}$, Unless Otherwise Specified (Continued)

PARAMETER	SYMBOL	TEST CONDITIONS	MIN	TYP	MAX	UNITS
Internal Drain Inductance	L_D	Measured From the Drain Lead, 2mm (0.08in) From Package to Center of Die	-	4.0	-	nH
Internal Source Inductance	L_S	Measured From the Source Lead, 2mm (0.08in) From Header to Source Bonding Pad	-	6.0	-	nH
Thermal Resistance Junction to Ambient	$R_{\theta JA}$	Typical Socket Mount	-	-	120	$^\circ\text{C/W}$

Source to Drain Diode Specifications

PARAMETER	SYMBOL	TEST CONDITIONS	MIN	TYP	MAX	UNITS
Continuous Source to Drain Current	I_{SD}	Modified MOSFET Symbol Showing the Integral Reverse P-N Junction Diode	-	-	-0.7	A
Pulse Source to Drain Current (Note 3)	I_{SDM}		-	-	-3.0	A
Source to Drain Diode Voltage (Note 2)	V_{SD}	$T_J = 25^\circ\text{C}$, $I_{SD} = -0.7\text{A}$, $V_{GS} = 0\text{V}$, (Figure 12)	-	-	-1.5	V
Reverse Recovery Time	t_{rr}	$T_J = 150^\circ\text{C}$, $I_{SD} = -0.7\text{A}$, $dI_{SD}/dt = 100\text{A}/\mu\text{s}$	-	120	-	ns
Reverse Recovery Charge	Q_{RR}	$T_J = 150^\circ\text{C}$, $I_{SD} = -0.7\text{A}$, $dI_{SD}/dt = 100\text{A}/\mu\text{s}$	-	6.0	-	μC

NOTES:

2. Pulse test: pulse width $\leq 300\mu\text{s}$, duty cycle $\leq 2\%$.
3. $V_{DD} = 25\text{V}$, starting $T_J = 25^\circ\text{C}$, $L = 582\text{mH}$, $R_G = 25\Omega$, peak $I_{AS} = 0.7\text{A}$. See Figures 14, 15.

Typical Performance Curves Unless Otherwise Specified

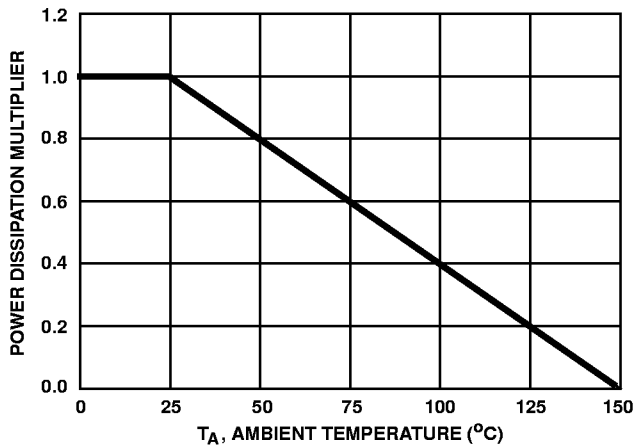

FIGURE 1. NORMALIZED POWER DISSIPATION vs AMBIENT TEMPERATURE

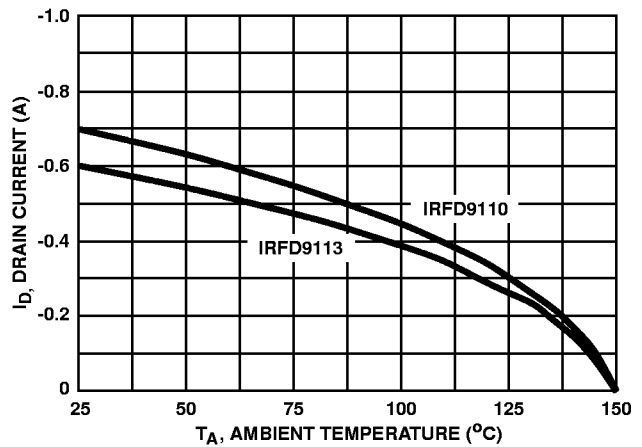

FIGURE 2. MAXIMUM CONTINUOUS DRAIN CURRENT vs AMBIENT TEMPERATURE

Typical Performance Curves Unless Otherwise Specified (Continued)

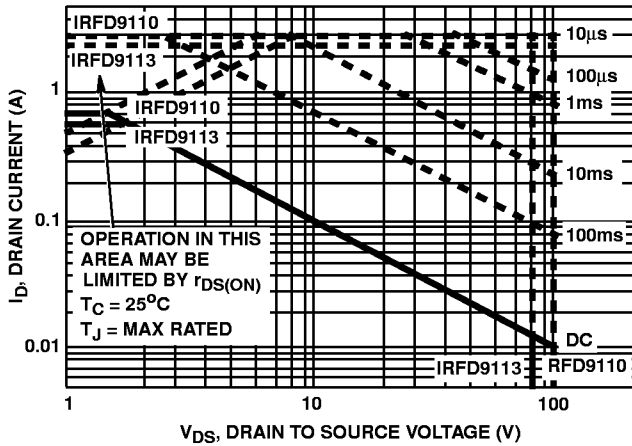

FIGURE 3. FORWARD BIAS SAFE OPERATING AREA

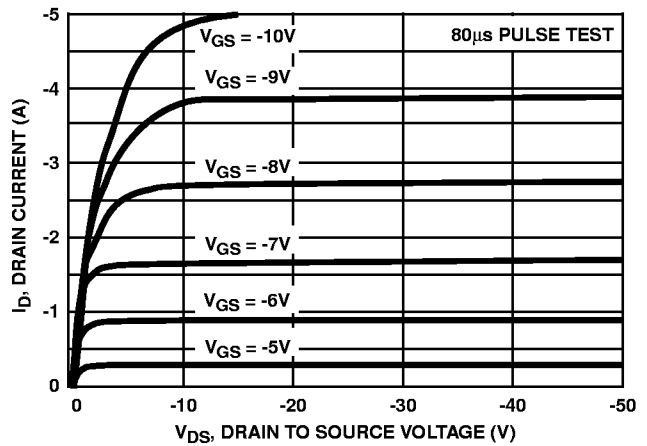

FIGURE 4. OUTPUT CHARACTERISTICS

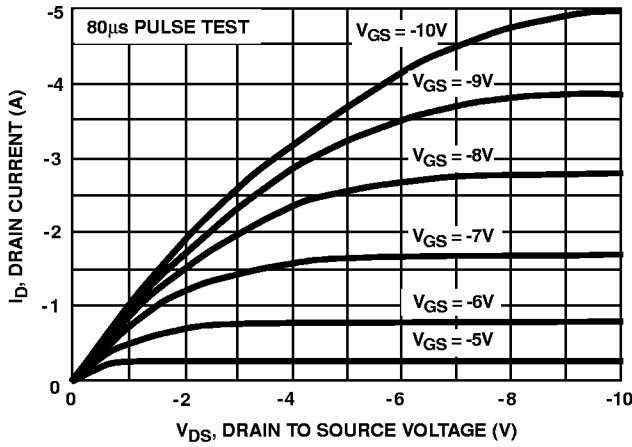

FIGURE 5. SATURATION CHARACTERISTICS

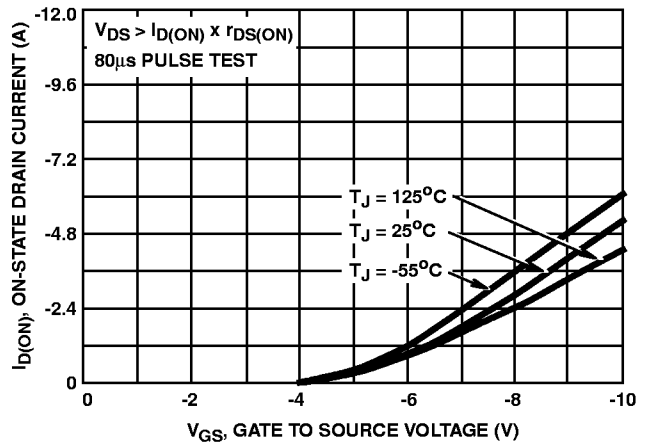
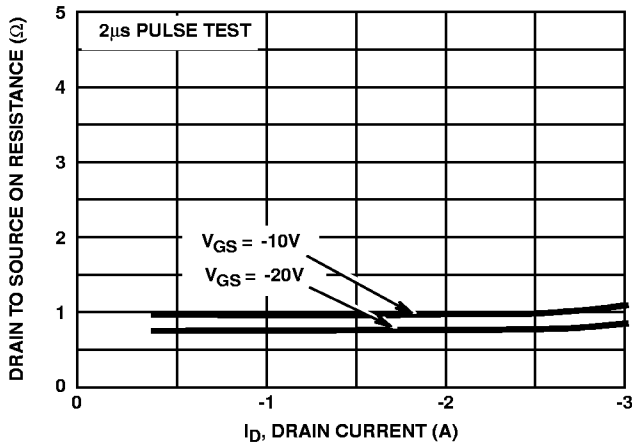

FIGURE 6. TRANSFER CHARACTERISTICS



NOTE: Heating effect of 2µs is minimal.

FIGURE 7. DRAIN TO SOURCE ON RESISTANCE vs GATE VOLTAGE AND DRAIN CURRENT

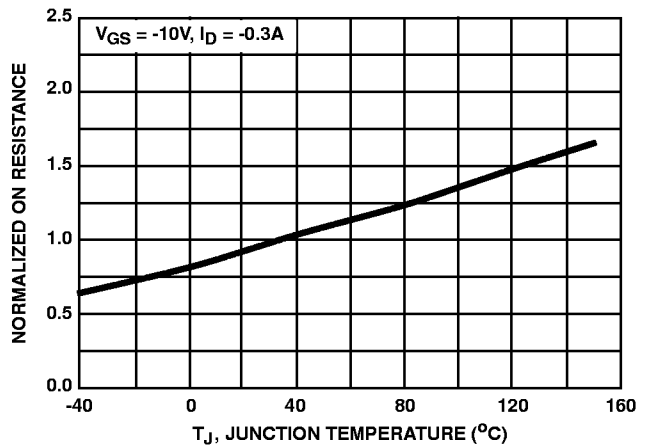

FIGURE 8. NORMALIZED DRAIN TO SOURCE ON RESISTANCE vs JUNCTION TEMPERATURE

Typical Performance Curves Unless Otherwise Specified (Continued)

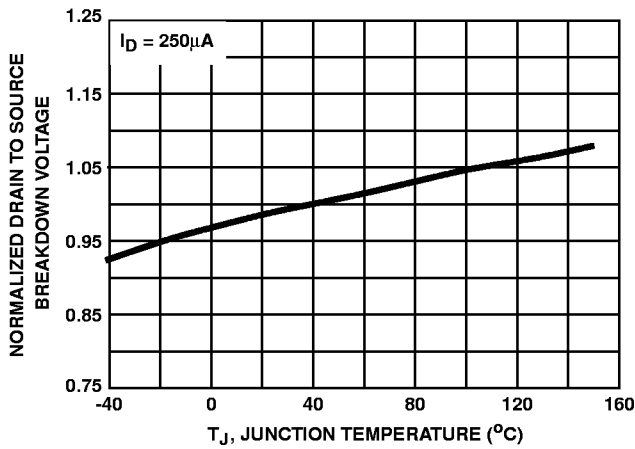

FIGURE 9. NORMALIZED DRAIN TO SOURCE BREAKDOWN VOLTAGE vs JUNCTION TEMPERATURE

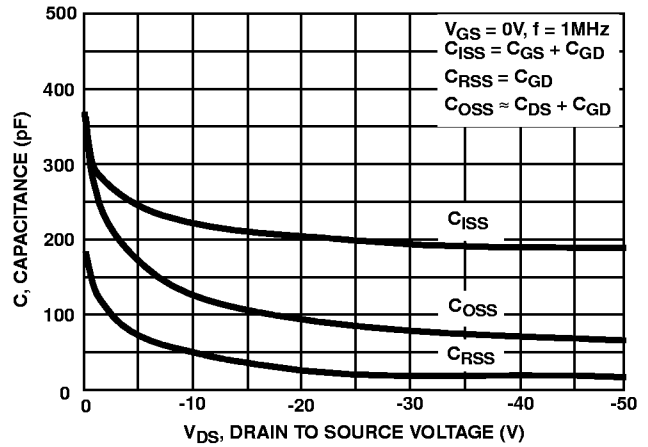

FIGURE 10. CAPACITANCE vs DRAIN TO SOURCE VOLTAGE

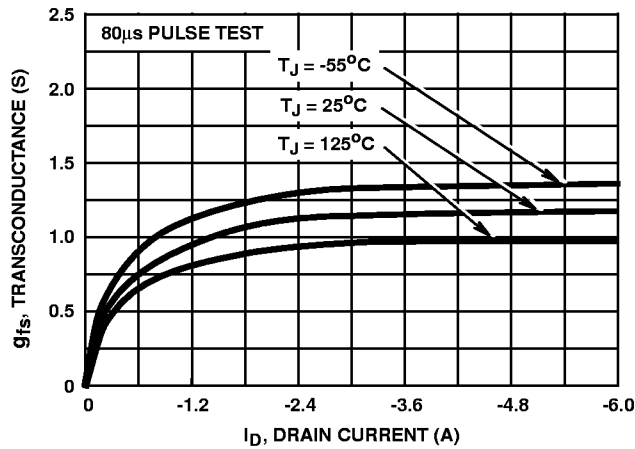

FIGURE 11. TRANSCONDUCTANCE vs DRAIN CURRENT

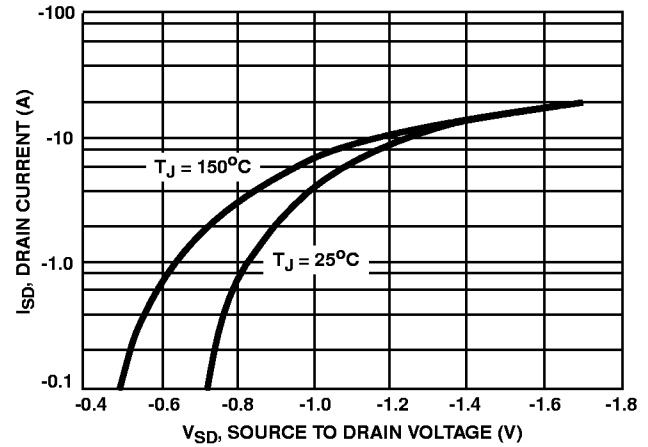

FIGURE 12. SOURCE TO DRAIN DIODE VOLTAGE

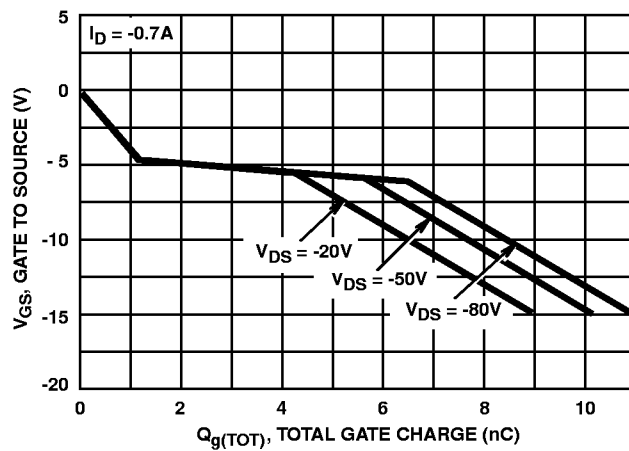

FIGURE 13. GATE TO SOURCE VOLTAGE vs GATE CHARGE

Test Circuits and Waveforms

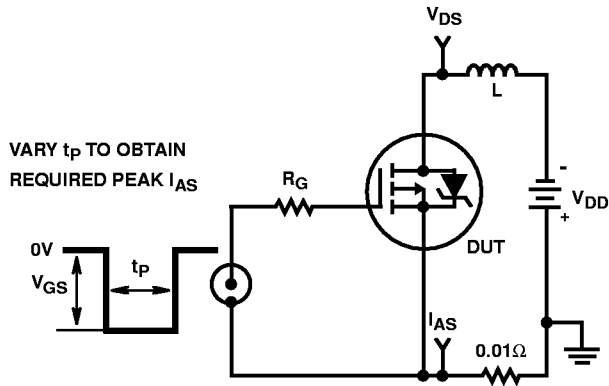

FIGURE 14. UNCLAMPED ENERGY TEST CIRCUIT

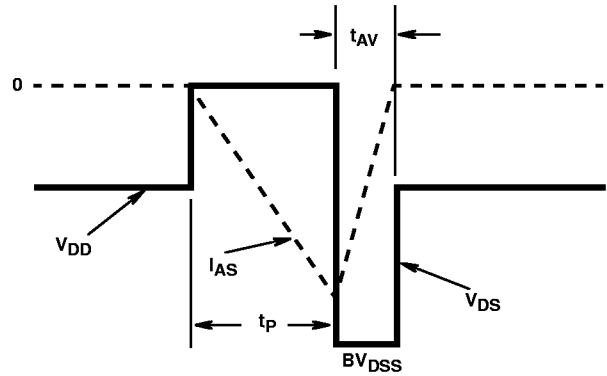

FIGURE 15. UNCLAMPED ENERGY WAVEFORMS

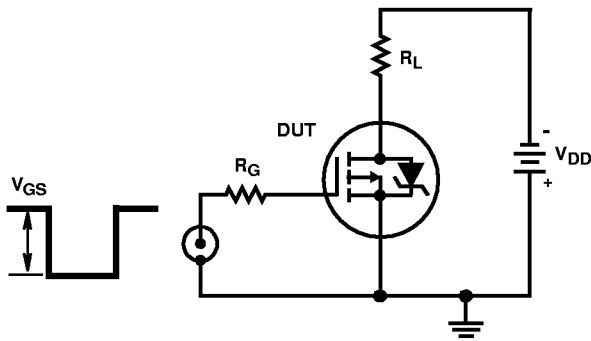

FIGURE 16. SWITCHING TIME TEST CIRCUIT

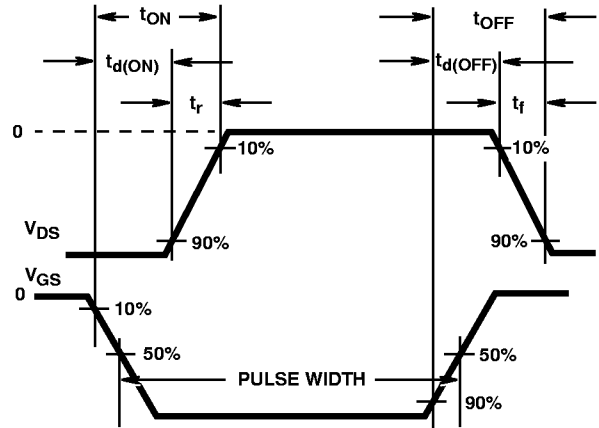

FIGURE 17. RESISTIVE SWITCHING WAVEFORMS

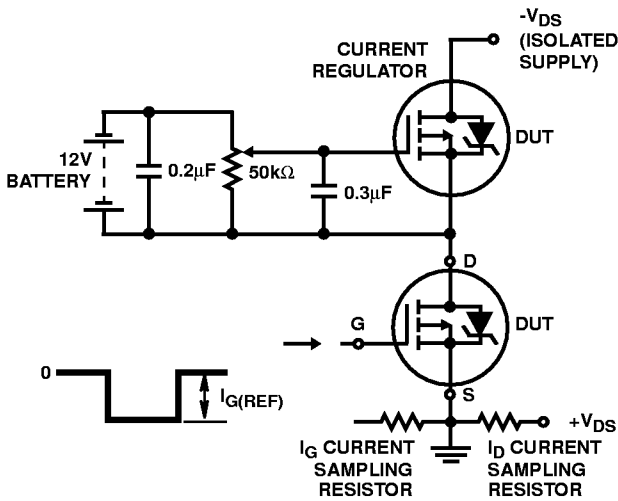

FIGURE 18. GATE CHARGE TEST CIRCUIT

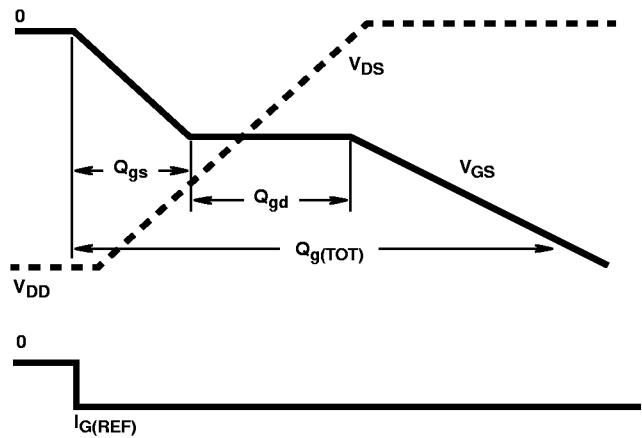

FIGURE 19. GATE CHARGE WAVEFORMS