

DETAILS

Product Number	CA14366_FLARE-MAXI-TAPE
Family	Flare
Type	Assembly
Color	clear
Diameter	33,9 + 33,3 mm
Height	16,9 mm
Style	rectang
Optic Material	PMMA
Holder Material	
Fastening	tape, pin
Status	production ready
ROHS Compliant	Yes
Date Updated	25/09/2015



OPTICAL PROPERTIES

LED	Viewing Angle	Light Beam	Efficiency	cd/lm	Connector
XP-G	105+11 deg	REC-class	94 %	2.500	-
XP-G2	96+10 deg	REC-class	94 %	3.100	-
XM-L	96+15 deg	REC-class	94 %	2.100	-
XT-E	96+10 deg	REC-class	94 %	2.500	-
XM-L2	105+13 deg	REC-class	96 %	-	-
XP-L	115+13 deg	REC-class	94 %	2.100	-
XHP35 HD	sim: 89+14	REC-class	sim: 91 %	sim: 2.200	-
XHP35 HI	sim: 82+10	REC-class	sim: 93 %	sim: 3.200	-
XP-L2	99+13 deg	REC-class	94 %	2.000	-
H35C1 (LEMWA33)	99+10 deg	REC-class	94 %	3.000	-
LUXEON H50-2	sim: 9.5+64	REC-class	sim: 92 %	sim: 3.600	-
LUXEON T	96+10 deg	REC-class	92 %	2.900	-
LUXEON Rebel ES	91+10 deg	REC-class	94 %	2.800	-
LUXEON TX	96+9 deg	REC-class	94 %	3.180	-
NCSxx19B	98+9 deg	REC-class	94 %	3.500	-
NVSxx19B/NVSxx19C	98+11 deg	REC-class	94 %	2.400	-
Oslon Square PC	98+13 deg	REC-class	94 %	2.500	-
LH351Z	94+8.8 deg	REC-class	94 %	3.600	-

Led position

Bottom view

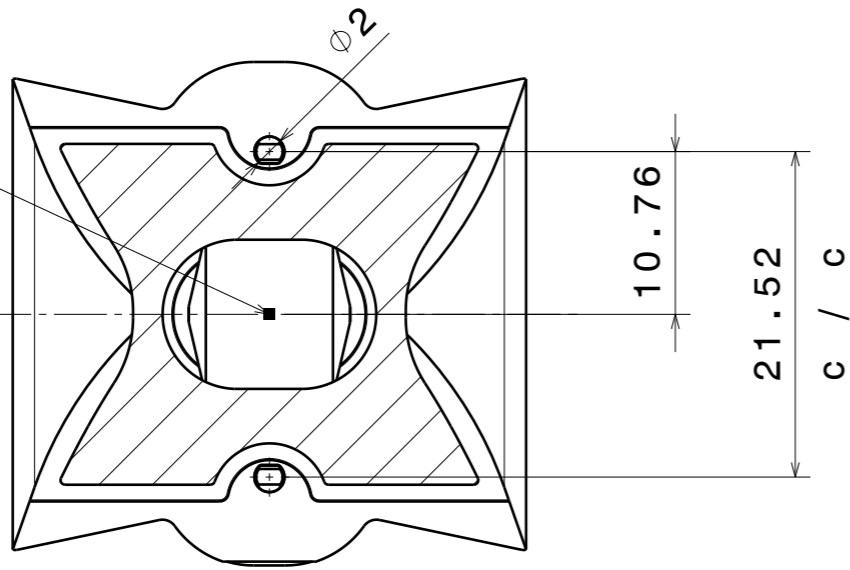

Lens

Tape

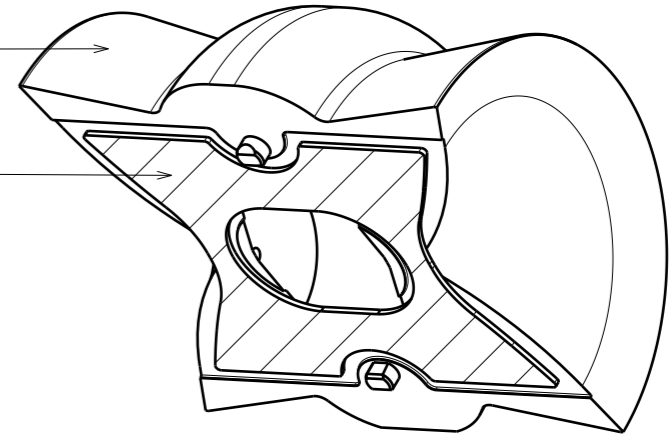

Isometric view

Front view

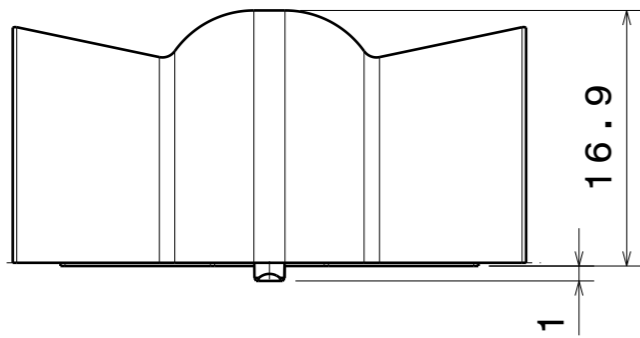

Top view

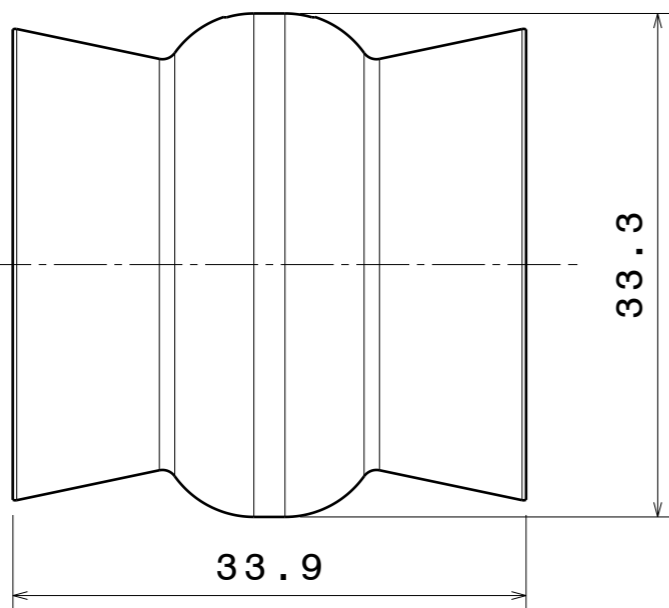

Material: PMMA 8N / PU 2-SIDED ADHESIVE FOAM TAPE

Tolerances if not otherwise shown
 According to DIN ISO 2768-1
 Linear measures:
 Up to 30mm class M, otherwise class C.
 According to DIN ISO 2768-2
 Form and position: class L



Ledil Oy
 Salorankatu 10
 FIN 24240 SALO
 Finland

THIRD ANGLE PROJECTION:

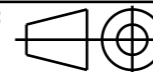

DRAWING TITLE

FLARE-MAXI (WITH TAPE)

SIZE

PART NUMBER

A3

FLARE-MAXI (WITH TAPE)

SCALE

1:1

WEIGHT

-

SHEET

1/1

This drawing is the property
 of LEDiL Oy. It may not be
 reproduced, copied or
 communicated without a written
 agreement with LEDiL Oy.

Luminaire: LEDiL Oy CA14366_FLARE-MAXI-TAPE_(XP-L)
Lamps: 1 x Cree_XP-L_130.2lm@250mA_P=0.73723W_I=249.9mA

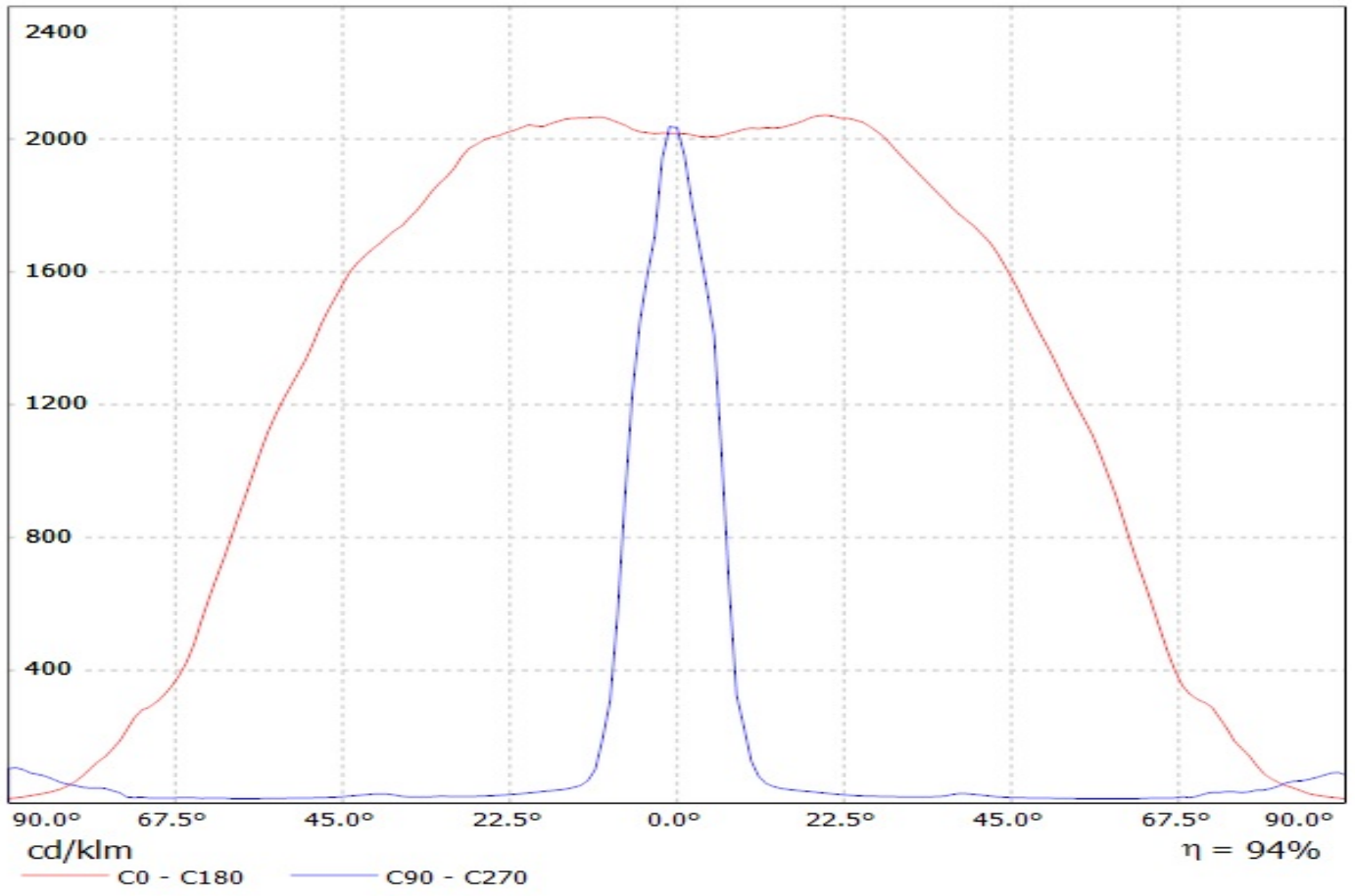

Luminaire: Ledil Oy CA14366_FLARE-MAXI-TAPE_(XHP35_HD)_SIMULATED
Lamps: 1 x Cree XHP35 HD

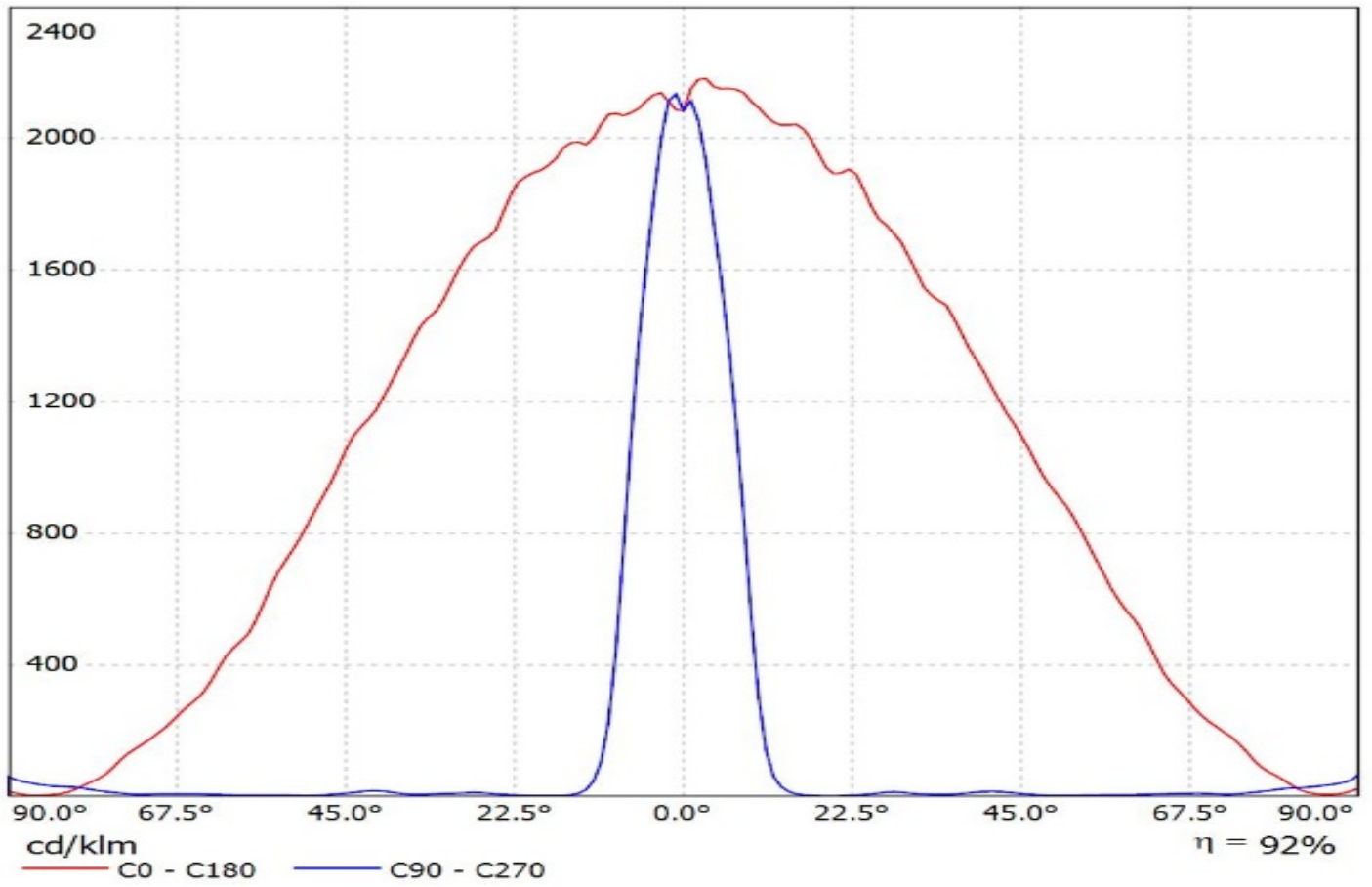

Luminaire: Ledil Oy CA14366_FLARE-MAXI-TAPE_(XHP35_HI)_SIMULATED
Lamps: 1 x Cree XHP35 HI

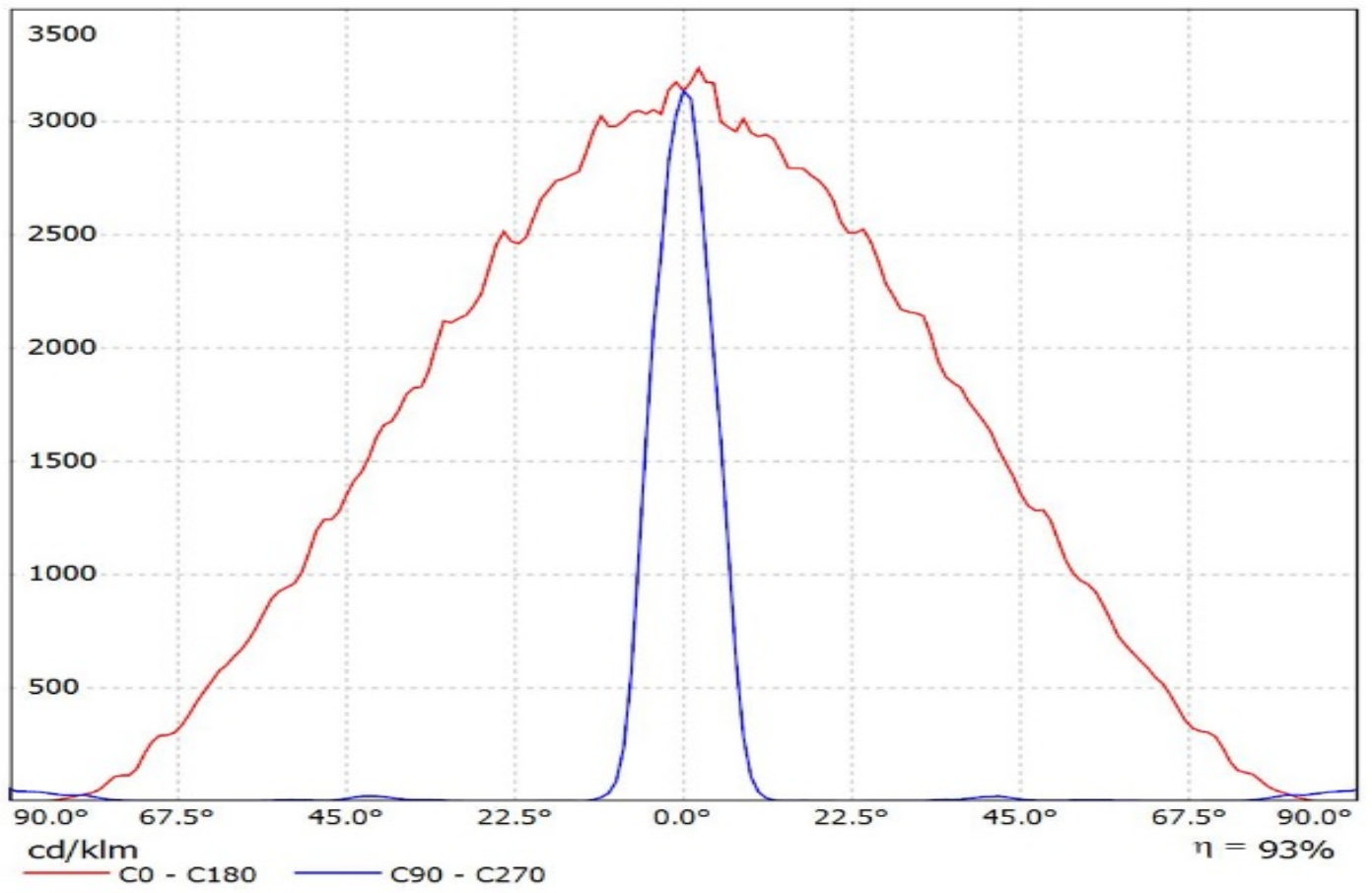

Luminaire: LEDiL Oy CA14366_FLARE-MAXI-TAPE_(Luxeon_TX) Eff.95.1%
Lamps: 1 x Luxeon_TX_(L1T2-3585)_80.1801lm@250mA_CCT=3500K_P=0.731482W_I=249.9mA

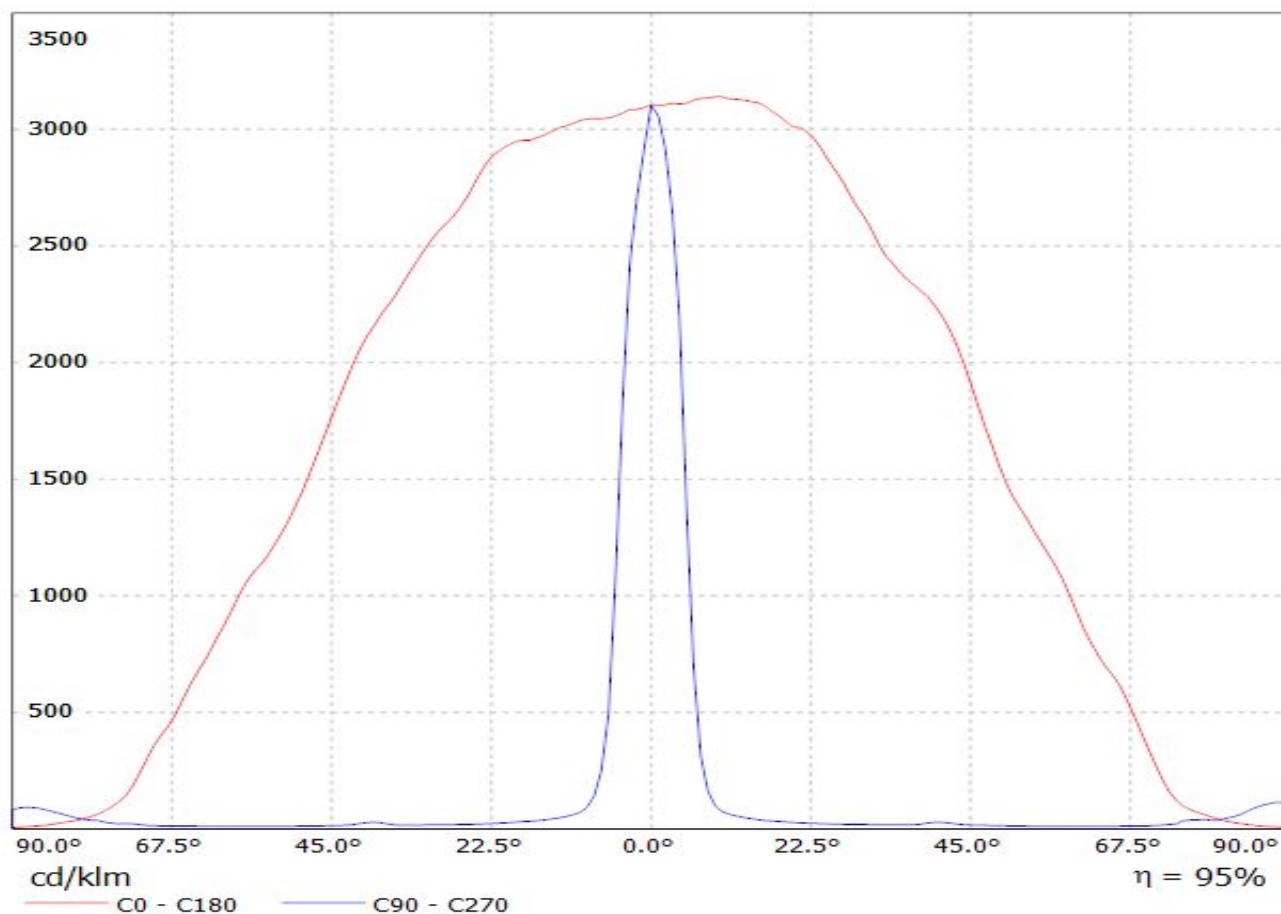

Luminaire: LEDiL Oy CA14366_FLARE-MAXI-TAPE_(LH351Z) Eff: 94%
Lamps: 1 x SAMSUNG_LH351Z_91.81lm@250mA_P=0.748076W_I=249.9mA

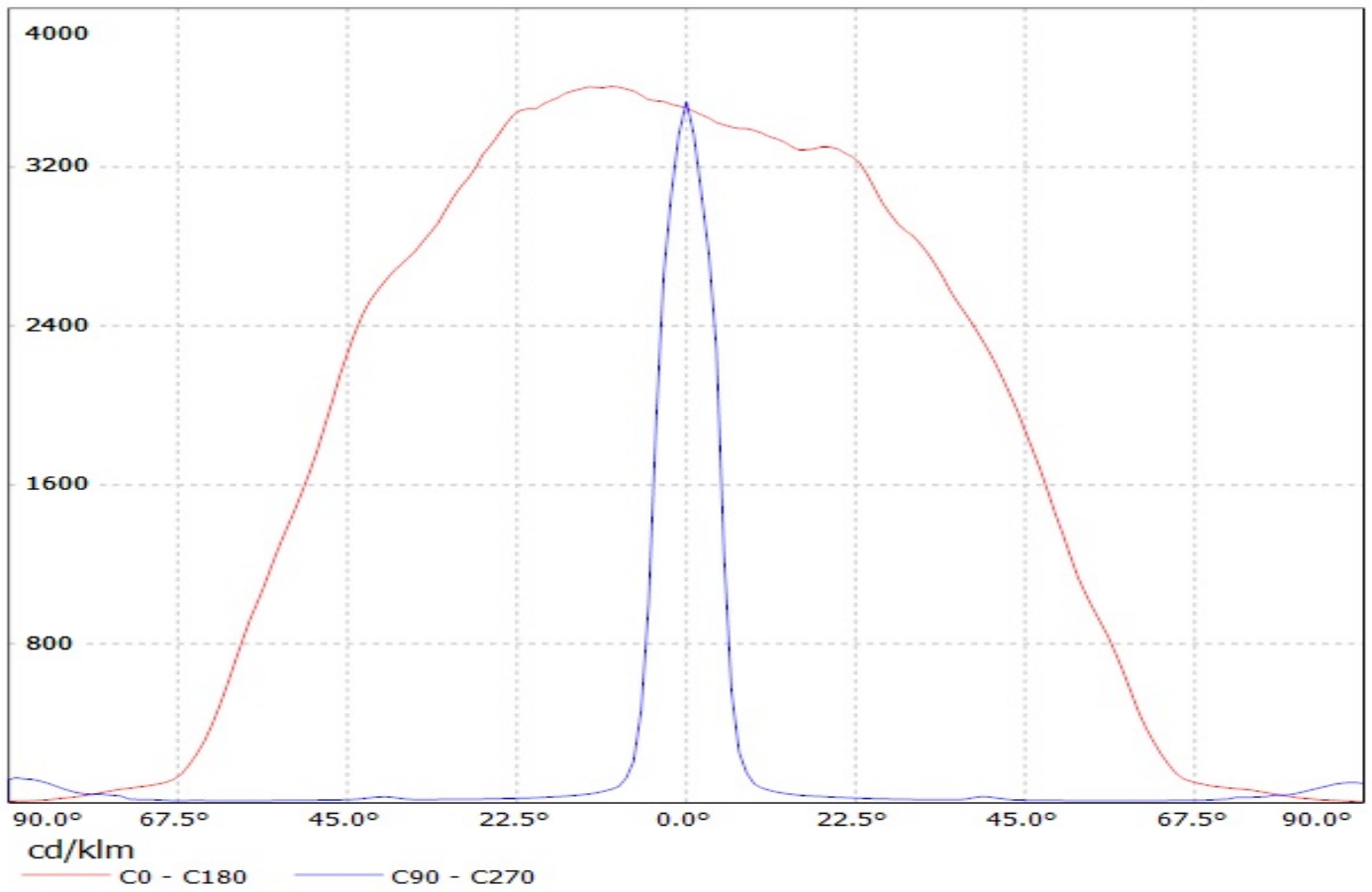

Luminaire: LEDiL Oy CA14366_FLARE-MAXI-TAPE_(XP-L)
Lamps: 1 x Cree_XP-L_130.2lm@250mA_P=0.73723W_I=249.9mA

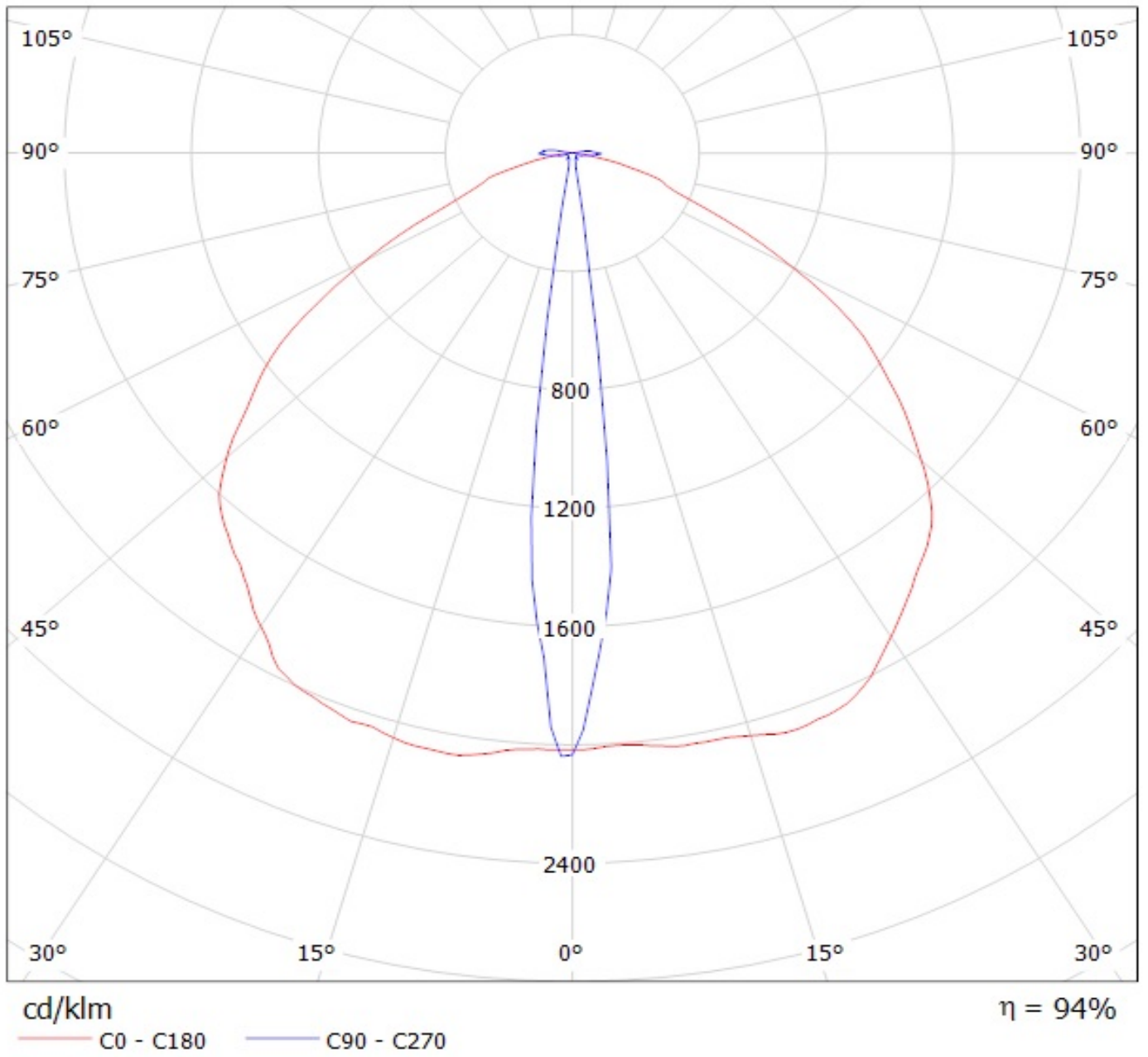

Luminaire: Ledil Oy CA14366_FLARE-MAXI-TAPE_(XHP35_HD)_SIMULATED
Lamps: 1 x Cree XHP35 HD

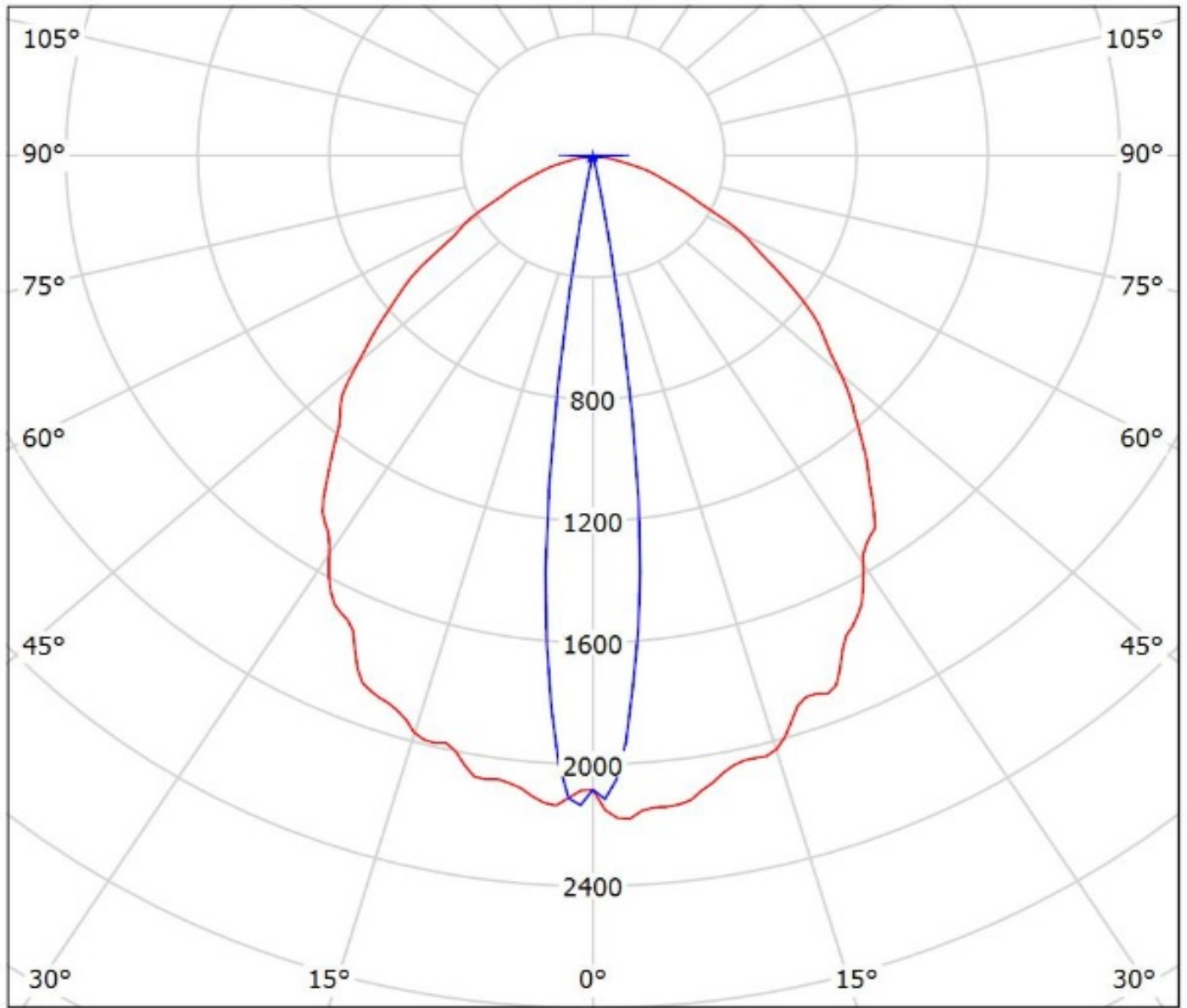

cd/klm

— C0 - C180 — C90 - C270

$\eta = 92\%$

Luminaire: Ledil Oy CA14366_FLARE-MAXI-TAPE_(XHP35_HI)_SIMULATED
Lamps: 1 x Cree XHP35 HI

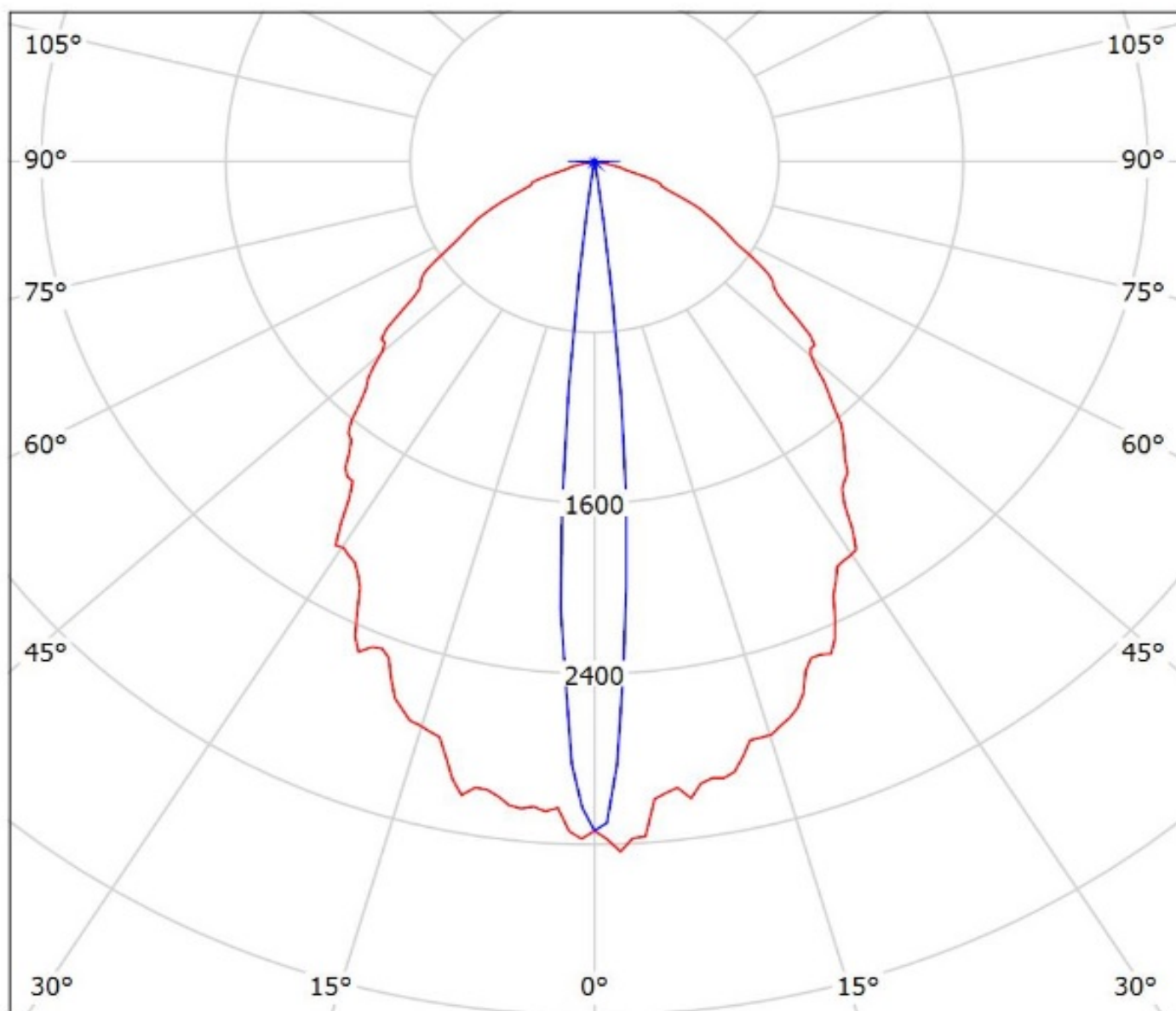

cd/klm
— C0 - C180 — C90 - C270

$\eta = 93\%$

Luminaire: Ledil CA14366_FLARE-MAXI-TAPE_(XP-L2)

Lamps: 1 x Cree_XP-L2_(XPLWT-00-0000-000HU630G)_115.505lm@250mA_P=0.72165W_I=0.25A

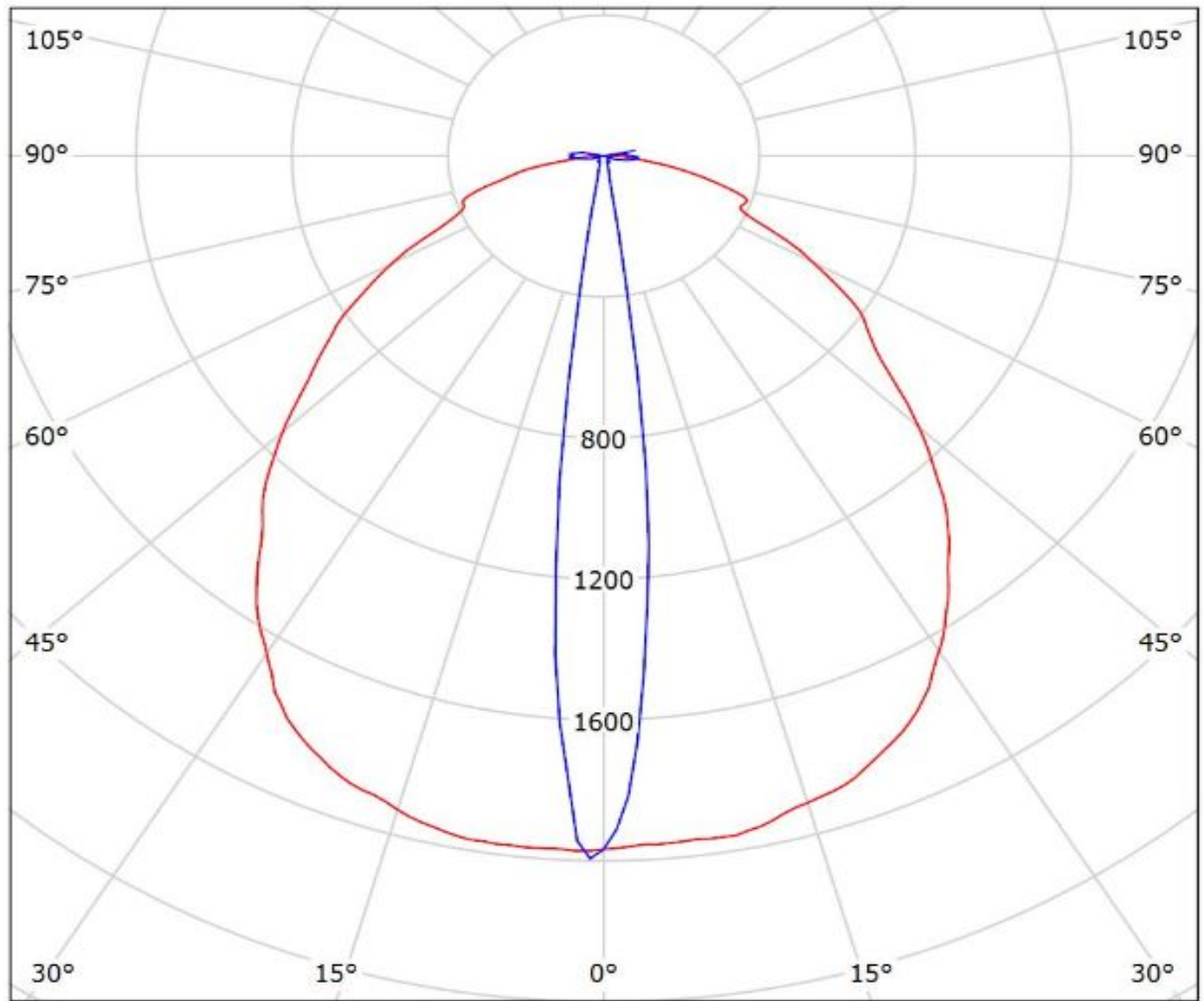

cd/klm

— C0 - C180

— C90 - C270

$\eta = 95\%$

Luminaire: LEDiL Oy CA14366_FLARE-MAXI-TAPE_(Luxeon_TX) Eff.95.1%

Lamps: 1 x Luxeon_TX_(L1T2-3585)_80.1801lm@250mA_CCT=3500K_P=0.731482W_I=249.9mA

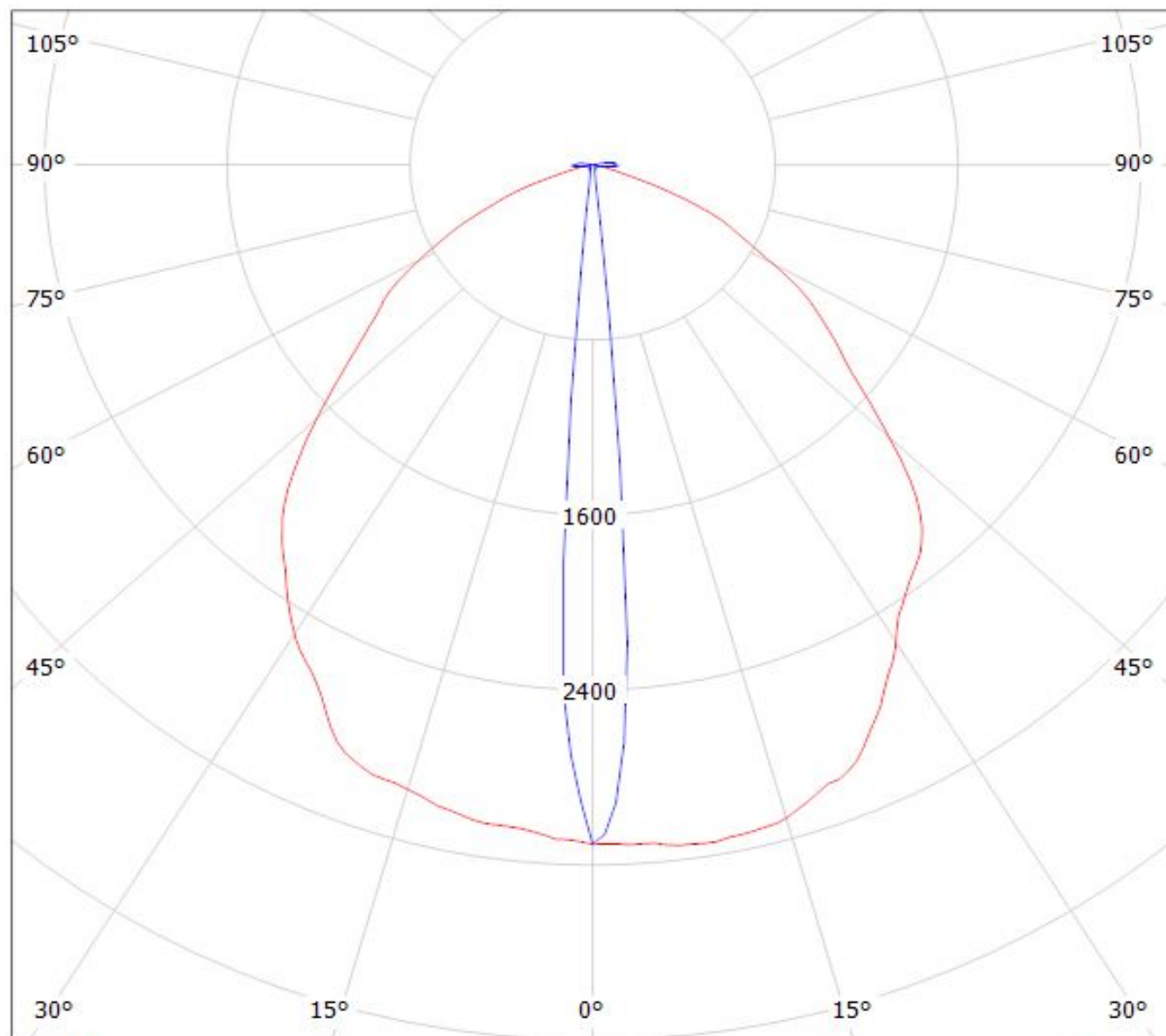

cd/klm

— C0 - C180

— C90 - C270

$\eta = 95\%$

Luminaire: LEDiL Oy CA14366_FLARE-MAXI-TAPE_(LH351Z) Eff: 94%
Lamps: 1 x SAMSUNG_LH351Z_91.81lm@250mA_P=0.748076W_I=249.9mA

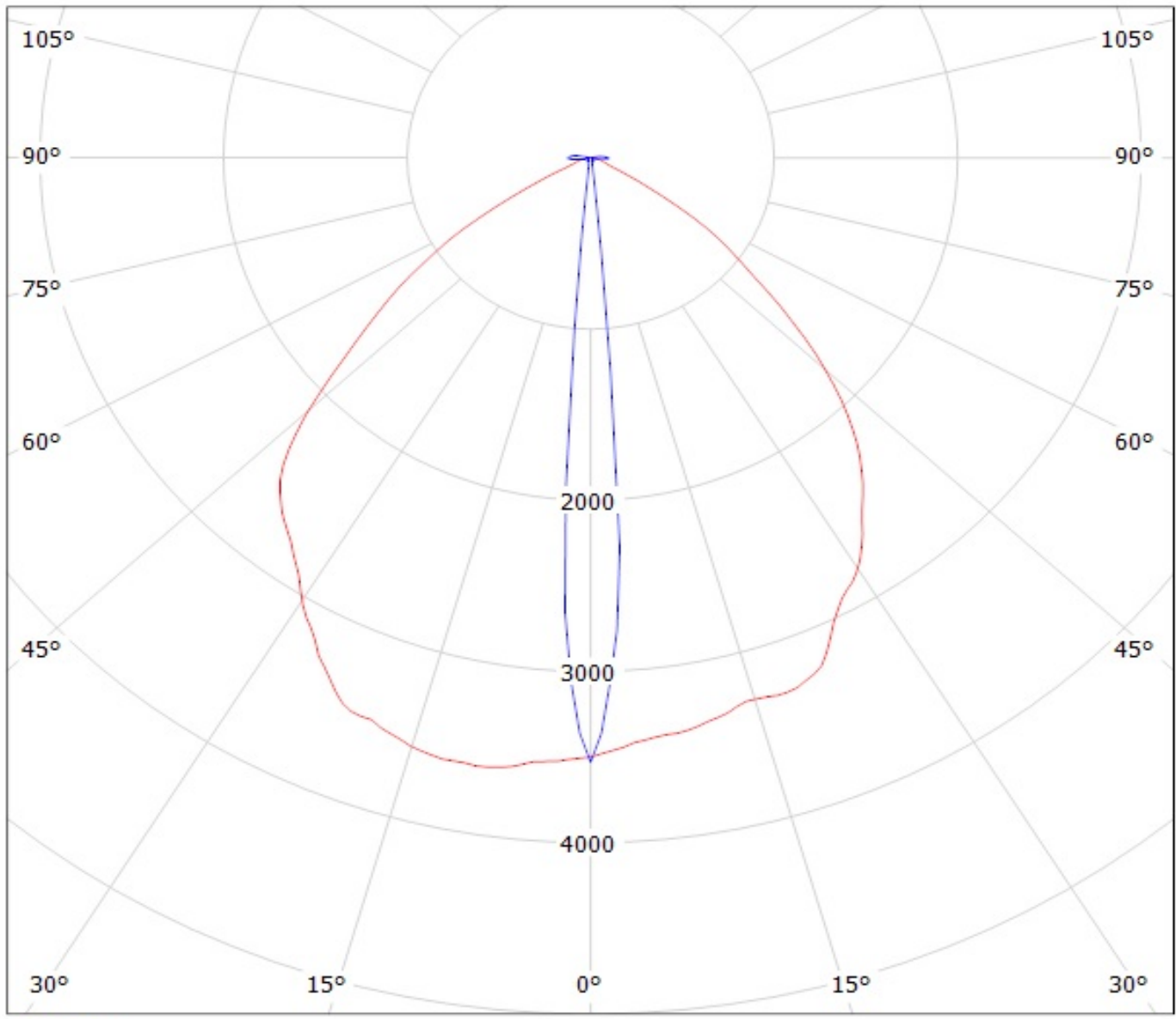

cd/klm
— C0 - C180 — C90 - C270

NOTE: The typical divergence will be changed by different color, chip size and chip position tolerance. The typical total divergence is the full angle measured where the luminous intensity is half of the peak value.