

**POWER MOSFET
 THRU-HOLE (TO-254AA)**

**IRFM250
 JANTX2N7225
 JANTXV2N7225
 REF:MIL-PRF-19500/592
 200V, N-CHANNEL
 HEXFET[®] MOSFET TECHNOLOGY**

Product Summary

Part Number	R _{DS(on)}	I _D
IRFM250	0.100 Ω	27.4A

HEXFET[®] MOSFET technology is the key to International Rectifier's advanced line of power MOSFET transistors. The efficient geometry design achieves very low on-state resistance combined with high transconductance. HEXFET transistors also feature all of the well-established advantages of MOSFETs, such as voltage control, very fast switching, ease of paralleling and electrical parameter temperature stability. They are well-suited for applications such as switching power supplies, motor controls, inverters, choppers, audio amplifiers, high energy pulse circuits, and virtually any application where high reliability is required. The HEXFET transistor's totally isolated package eliminates the need for additional isolating material between the device and the heatsink. This improves thermal efficiency and reduces drain capacitance.

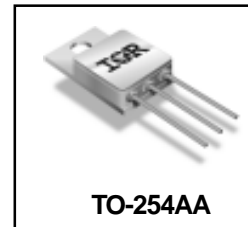

TO-254AA

Features:

- Simple Drive Requirements
- Ease of Paralleling
- Hermetically Sealed
- Electrically Isolated
- Dynamic dv/dt Rating
- Light-weight

Absolute Maximum Ratings

	Parameter		Units
I _D @ V _{GS} = 10V, T _C = 25°C	Continuous Drain Current	27.4	A
I _D @ V _{GS} = 10V, T _C = 100°C	Continuous Drain Current	17	
I _{DM}	Pulsed Drain Current ①	110	
P _D @ T _C = 25°C	Max. Power Dissipation	150	W
	Linear Derating Factor	1.2	W/°C
V _{GS}	Gate-to-Source Voltage	±20	V
E _{AS}	Single Pulse Avalanche Energy ②	500	mJ
I _{AR}	Avalanche Current ①	27.4	A
E _{AR}	Repetitive Avalanche Energy ①	15.0	mJ
dv/dt	Peak Diode Recovery dv/dt ③	5.0	V/ns
T _J	Operating Junction	-55 to 150	°C
T _{STG}	Storage Temperature Range		
	Lead Temperature	300 (0.063 in.(1.6mm) from case for 10s)	
	Weight	9.3 (Typical)	g

For footnotes refer to the last page

Electrical Characteristics @ T_j = 25°C (Unless Otherwise Specified)

	Parameter	Min	Typ	Max	Units	Test Conditions
BV _{DSS}	Drain-to-Source Breakdown Voltage	200	—	—	V	V _{GS} = 0V, I _D = 1.0mA
ΔBV _{DSS} /ΔT _J	Temperature Coefficient of Breakdown Voltage	—	0.28	—	V/°C	Reference to 25°C, I _D = 1.0mA
R _{DS(on)}	Static Drain-to-Source On-State Resistance	—	—	0.100 0.105	Ω	V _{GS} = 10V, I _D = 17A ④ V _{GS} = 10V, I _D = 27.4A
V _{GS(th)}	Gate Threshold Voltage	2.0	—	4.0	V	V _{DS} = V _{GS} , I _D = 250μA
g _{fs}	Forward Transconductance	9.0	—	—	S (r _θ)	V _{DS} > 15V, I _{DS} = 17A ④
I _{DSS}	Zero Gate Voltage Drain Current	—	—	25 250	μA	V _{DS} = 160V, V _{GS} = 0V V _{DS} = 160V, V _{GS} = 0V, T _J = 125°C
I _{GSS}	Gate-to-Source Leakage Forward	—	—	100	nA	V _{GS} = 20V
I _{GSS}	Gate-to-Source Leakage Reverse	—	—	-100	nA	V _{GS} = -20V
Q _g	Total Gate Charge	—	—	115	nC	V _{GS} = 10V, I _D = 27.4A
Q _{gs}	Gate-to-Source Charge	—	—	22	nC	V _{DS} = 100V
Q _{gd}	Gate-to-Drain ('Miller') Charge	—	—	60	nC	
t _{d(on)}	Turn-On Delay Time	—	—	35	ns	V _{DD} = 50V, I _D = 44A, V _{GS} = 10V, R _G = 2.35Ω
t _r	Rise Time	—	—	190		
t _{d(off)}	Turn-Off Delay Time	—	—	170		
t _f	Fall Time	—	—	130		
L _S + L _D	Total Inductance	—	6.8	—	nH	Measured from drain lead (6mm/0.25in. from package) to source lead (6mm/0.25in. from package)
C _{iss}	Input Capacitance	—	3500	—	pF	V _{GS} = 0V, V _{DS} = 25V f = 1.0MHz
C _{oss}	Output Capacitance	—	700	—		
C _{rss}	Reverse Transfer Capacitance	—	110	—		
C _{DC}	Drain-to-Case Capacitance	—	12	—		

Source-Drain Diode Ratings and Characteristics

	Parameter	Min	Typ	Max	Units	Test Conditions
I _S	Continuous Source Current (Body Diode)	—	—	27.4	A	
I _{SM}	Pulse Source Current (Body Diode) ①	—	—	110		
V _{SD}	Diode Forward Voltage	—	—	1.9	V	T _j = 25°C, I _S = 27.4A, V _{GS} = 0V ④
t _{rr}	Reverse Recovery Time	—	—	950	nS	T _j = 25°C, I _F = 27.4A, di/dt ≤ 100A/μs
Q _{RR}	Reverse Recovery Charge	—	—	9.0	μC	V _{DD} ≤ 50V ④
t _{on}	Forward Turn-On Time	Intrinsic turn-on time is negligible. Turn-on speed is substantially controlled by L _S + L _D .				

Thermal Resistance

	Parameter	Min	Typ	Max	Units	Test Conditions
R _{thJC}	Junction-to-Case	—	—	0.83	°C/W	Typical socket mount
R _{thJCS}	Case-to-Sink	—	0.21	—		
R _{thJA}	Junction-to-Ambient	—	—	48		

Note: Corresponding Spice and Saber models are available on the G&S Website.

For footnotes refer to the last page

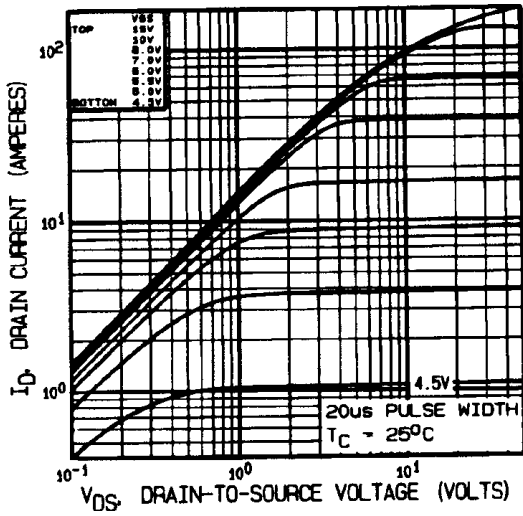

Fig 1. Typical Output Characteristics

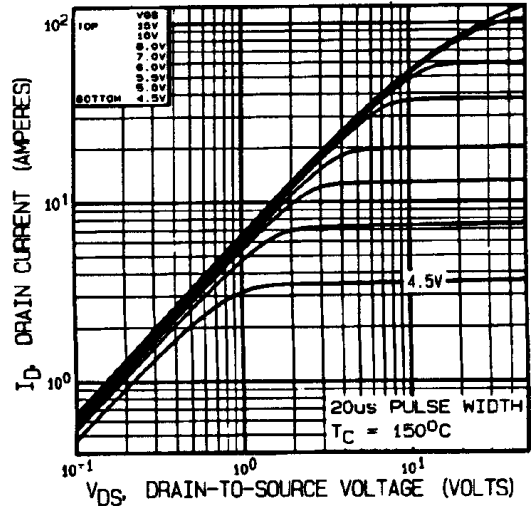

Fig 2. Typical Output Characteristics

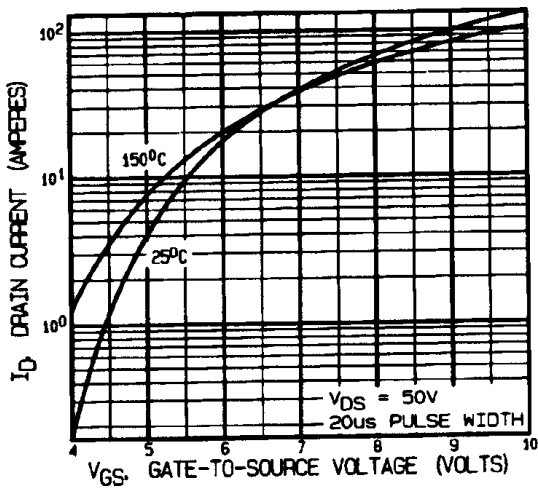

Fig 3. Typical Transfer Characteristics

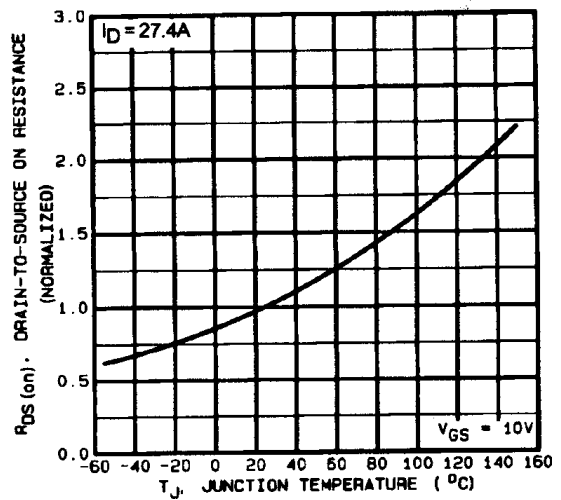

Fig 4. Normalized On-Resistance Vs. Temperature

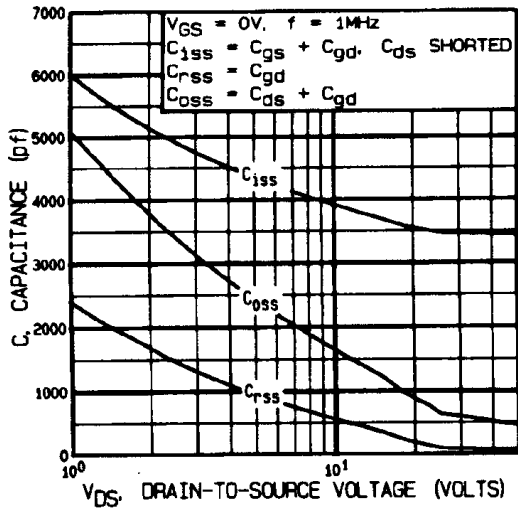

Fig 5. Typical Capacitance Vs. Drain-to-Source Voltage

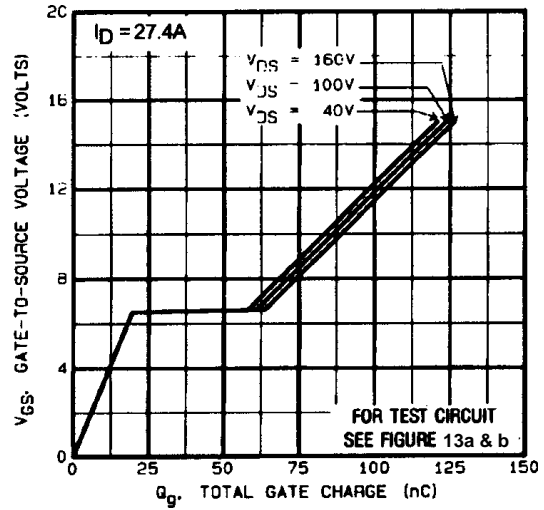

Fig 6. Typical Gate Charge Vs. Gate-to-Source Voltage

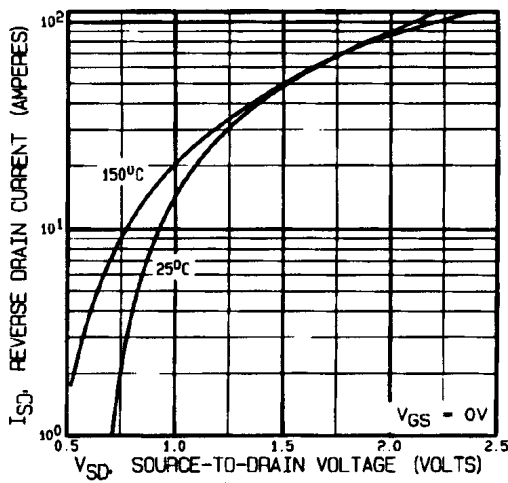

Fig 7. Typical Source-Drain Diode Forward Voltage

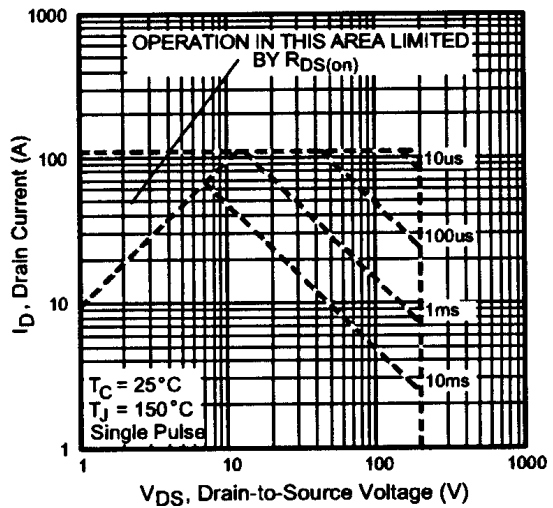

Fig 8. Maximum Safe Operating Area

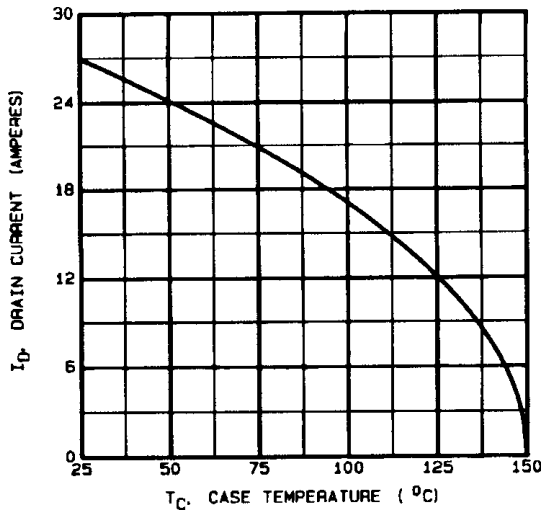

Fig 9. Maximum Drain Current Vs. Case Temperature

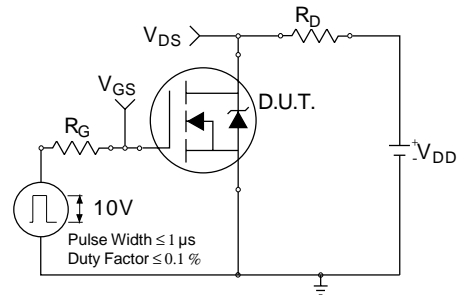

Fig 10a. Switching Time Test Circuit

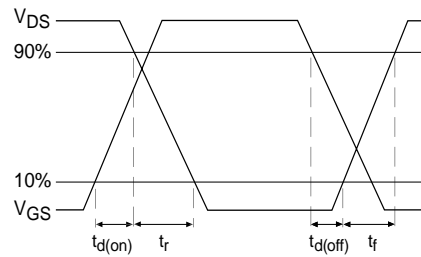

Fig 10b. Switching Time Waveforms

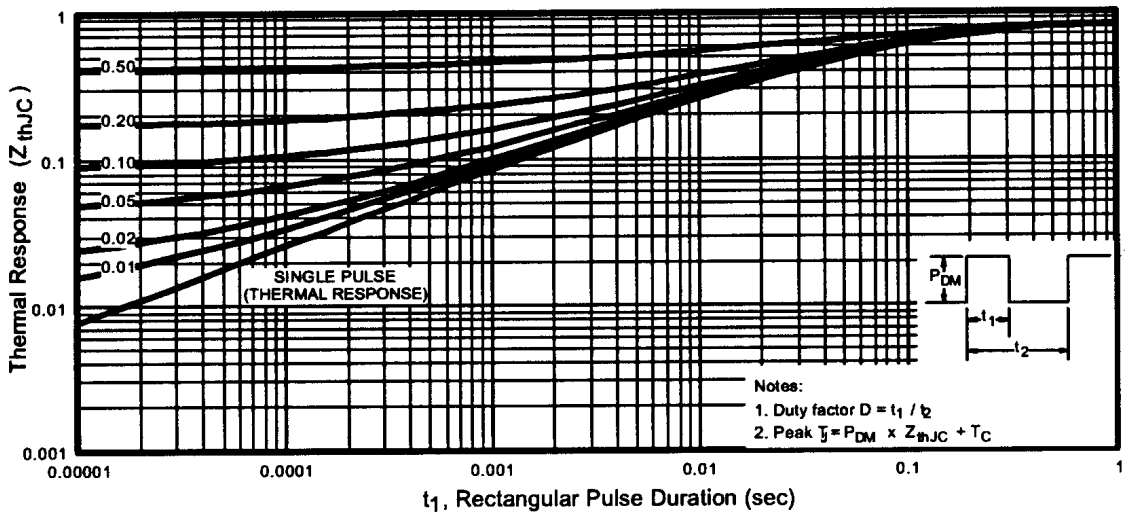

Fig 11. Maximum Effective Transient Thermal Impedance, Junction-to-Case

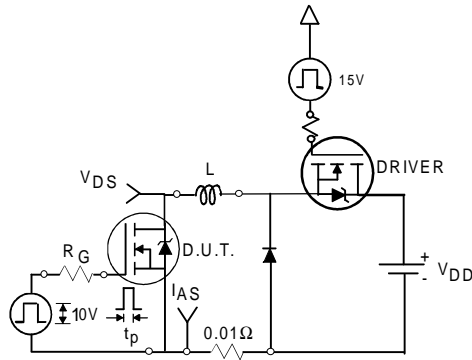

Fig 12a. Unclamped Inductive Test Circuit

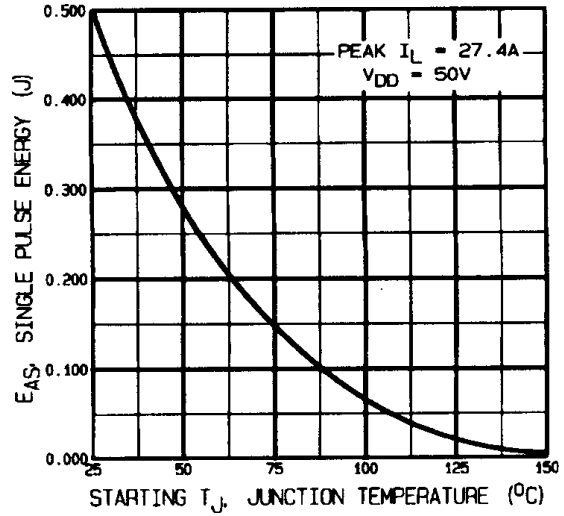

Fig 12c. Maximum Avalanche Energy Vs. Drain Current

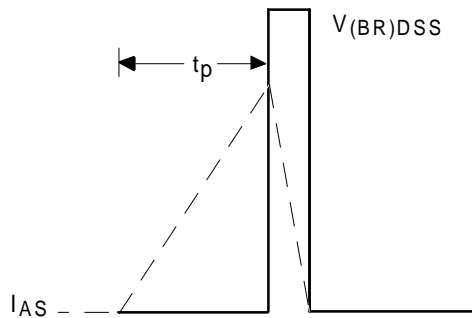

Fig 12b. Unclamped Inductive Waveforms

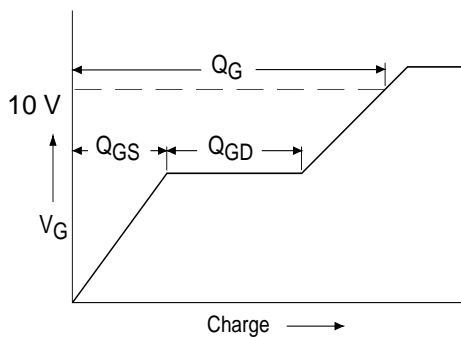

Fig 13a. Basic Gate Charge Waveform

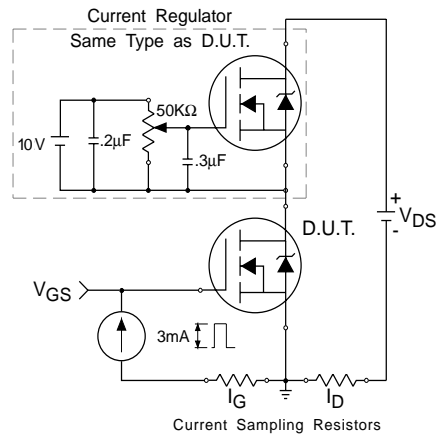
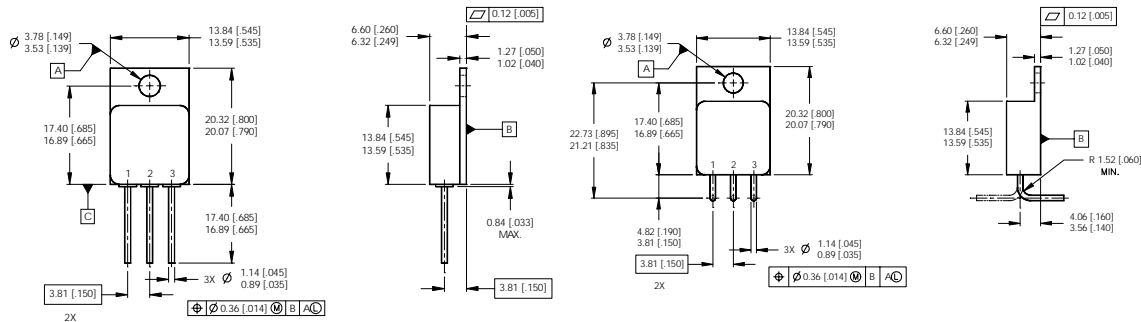

Fig 13b. Gate Charge Test Circuit

Footnotes:

- ① Repetitive Rating; Pulse width limited by maximum junction temperature.
- ② $V_{DD} = 50V$, starting $T_J = 25^\circ C$, $L = 1.33mH$
 Peak $I_L = 27.4A$, $V_{GS} = 10V$
- ③ $I_{SD} \leq 27.4A$, $di/dt \leq 190A/\mu s$,
 $V_{DD} \leq 200V$, $T_J \leq 150^\circ C$
- ④ Pulse width $\leq 300 \mu s$; Duty Cycle $\leq 2\%$

Case Outline and Dimensions — TO-254AA



NOTES:
 1. DIMENSIONING & TOLERANCING PER ASME Y14.5M-1994.
 2. ALL DIMENSIONS ARE SHOWN IN MILLIMETERS [INCHES].
 3. CONTROLLING DIMENSION: INCH.
 4. CONFORMS TO JEDEC OUTLINE TO-254AA.

PIN ASSIGNMENTS
 1 = DRAIN
 2 = SOURCE
 3 = GATE

CAUTION

BERYLLIA WARNING PER MIL-PRF-19500

Packages containing beryllia shall not be ground, sandblasted, machined or have other operations performed on them which will produce beryllia or beryllium dust. Furthermore, beryllium oxide packages shall not be placed in acids that will produce fumes containing beryllium.