

# Amphenol

CATALOG NO.  
ACR 11 REV06/02

**MS/97 SERIES STANDARD  
CIRCULAR THREAD COUPLED  
SOLDER AND CRIMP  
CONNECTORS**

**97B SERIES STANDARD  
CIRCULAR REVERSE  
BAYONET COUPLED  
SOLDER AND CRIMP  
CONNECTORS**



## Introduction

Amphenol MS and 97 series are two series of thread-coupled connectors designed to meet the operating requirements of **MIL-C-5015**. Available in a variety of styles and classes, these connectors are primarily used in a range of military and industrial applications where specific degrees of environmental protection are required.

Although both MS and 97 series have identical insert arrangements and other similar component parts, the two series differ in that Amphenol MS series of connectors are also qualified to meet the operating requirements of Defence Standard Joint Services Specification **JSS50812**, issued by the Electronics Components Standardization Organisation (LCSO).

Amphenol 97 series is exclusively designed to meet the needs of industry, which may call for deviations from MIL specification.

Amphenol 97B connectors feature a quick mating bayonet coupling with an audible full mating feature. This series uses the same **MIL-C-5015** insert patterns and are used in high shock and vibration environments encountered in commercial, geophysical, aerospace, ground support and shipboard applications.

### Page Contents

1	Introduction
2-5	Connector styles
6	General description
7	Electrical data
8	Insert orientations
9-19	Insert arrangements
20-25	Shell types
26-28	Back accessories
29-32	Other accessories
33	Ordering Ms, 97 and 97B series connectors
36	Facts & Figures

**Connector styles**

**Class F  
(Class R w/o  
cableclamp)**

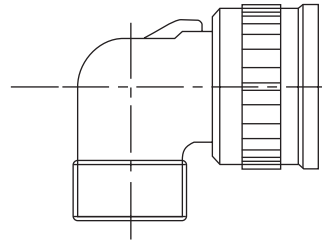
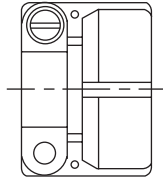

**Class A**

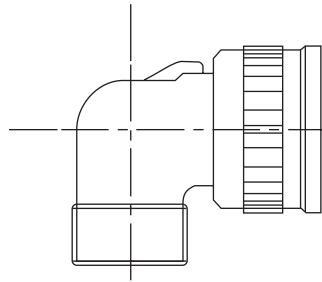

**Class A**

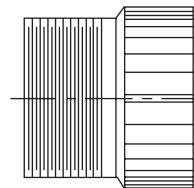

**Class E and F**

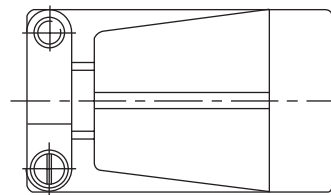

**Class R**

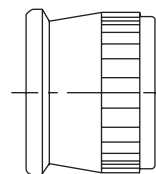

**cable  
clamp**

**back  
shell**

Connector styles

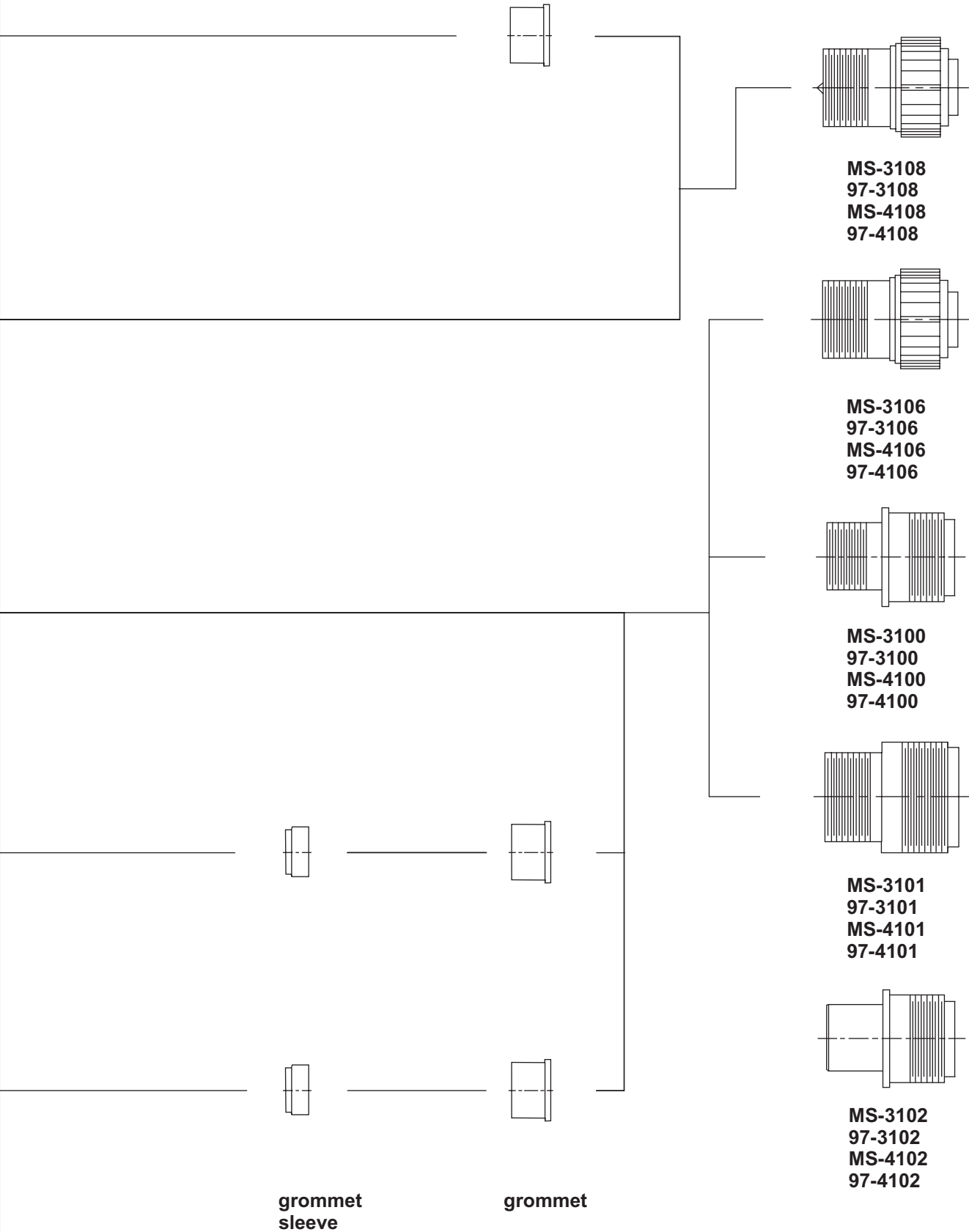

**Class F  
(Class R w/o  
cableclamp)**

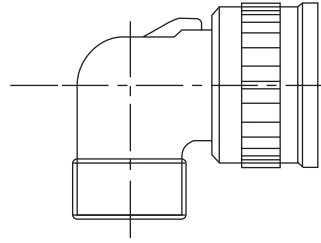
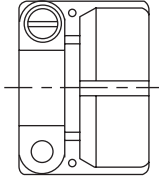

**Class A**

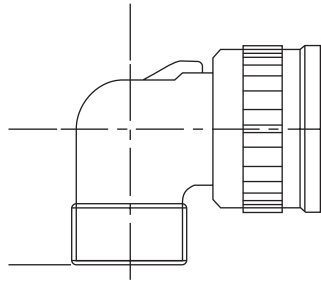

**Class A**

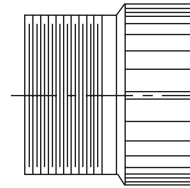

**Class F**

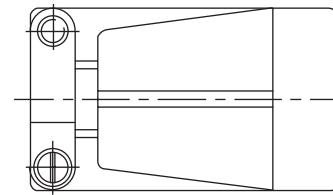

**Class R**

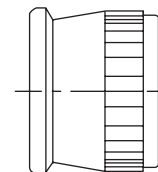

**clamp  
cable**

**back  
shell**

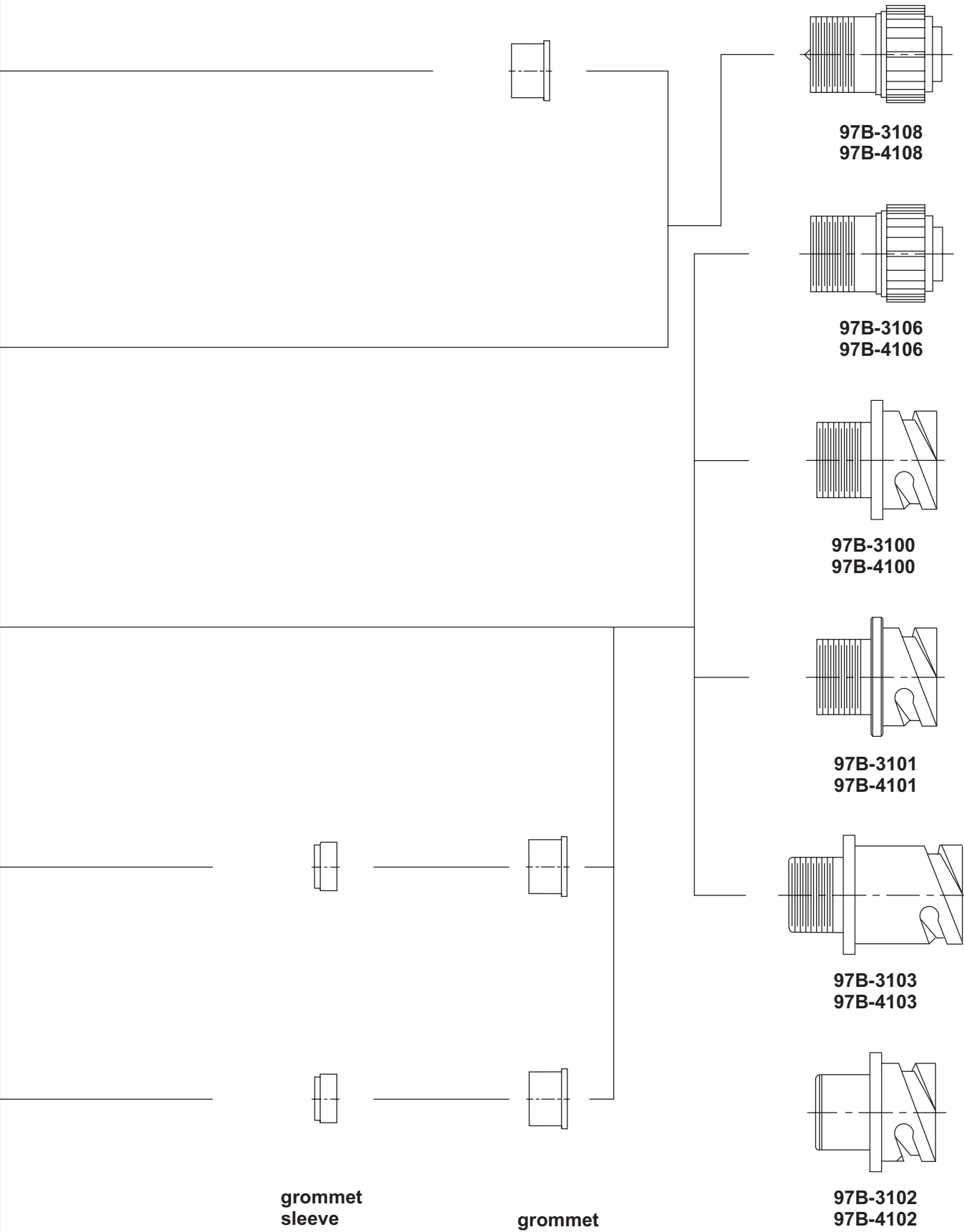

## General description

These electrical connectors are designated MS because the interchangeability and operating characteristics are determined by U. S. Military Specifications. These specifications are revised from time to time to incorporate performance requirements dictated by design advances and more stringent requirements of allied equipment. The several designations of MS, 97 and 97B connectors meet different requirements of MIL-C-5015. These designations and general descriptions are as follows

### Shell

Shell constructions include solid back shell (A) and environmental resistant (E, F & R). Environmental resistant connectors provide a moisture barrier and assure a positive seal. Shell styles consist of wall type receptacles (3100), cable receptacles (3101), box receptacles (3102), straight plugs (3106) and angle plugs (3108). Shell hardware is manufactured from aluminium alloy and cadmium plated with olive drab chromate finish. This finish has excellent conductivity it is non-reflecting and corrosion resistant. Black anodised finish and cadmium-free zinc plating with olive drab chromate finish are also available. For details, contact factory.

### Contacts

Pin and socket contacts are of brass and generally silver plated. Gold plating is also available. For details contact factory. These contacts are available for solder or crimp termination. Special arrangements of contacts for pre-mating and pre-earth are also available.

### Inserts and grommet

Synthetic inserts and grommet manufactured according to MIL-R-3065, offer high dielectric strength and are resistant to oils, gasoline and low temperature. 97 series inserts use Diallyl hthalate ( Blue DAP). DAP is dimensionally stable, has high arc resistance and high insulation resistance under both humidity and thermal stress.

### General description

Plugs are available in A, F and R types. Receptacles are available in A, E, F and R types.

### A solid backshell

Intended for general service usage to provide convenient means of connecting and disconnecting electrical circuits in industrial and military applications.

### Environmental resisting

Intended for use where the connector will be subject to heavy condensation and rapid changes in temperature or pressure and/or where the connector is subjected to high vibratory conditions.

**E** Environmental resisting with grommet seal and strain relief backshell except for 3102 type.

Environmental resisting with grommet seal, strain relief backshell and front gasket seal for plug type.

**R** Environmental resisting with grommet seal, shorter and lightweight.

---

## Electrical data

### Dielectric strength

Service rating	Test oltage Vac ms
Inst.	1000V
A	2000V
D	2800V
E	3500V
B	500V
C	7000V

### Contact rating

Contact Size	Rated Current	Contact Resistance miliohms
16	13A	3.6
12	23A	1.83
8	6A	0.52
4	80A	0.26
0	150A	0.1

### Service rating

Service rating	Operating oltage DC at Sea Level	Operating oltage AC at Sea Level
Inst.	250V	200V
A	700V	500V
D	1250V	900V
E	1750V	1250V
B	2 50V	1750V
C	200V	3000V



**Insert orientations**

To avoid cross-plugging problems in applications requiring the use of more than one connector of the same size and arrangement, alternate insert rotations are available as indicated in the accompanying chart.

As shown in the daigram below, the front face of the pin insert is rotated within the shell in a clockwise direction from the normal shell key. The socket insert would be rotated counterclockwise the same number of degrees with respect to the normal shell key.

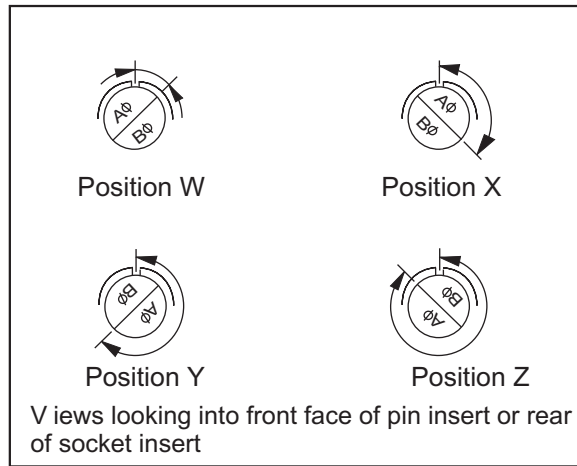

The following insert arrangements have the same alternate insert rotations for W,X,Y and Z which are as below :

Degree			
W	X	Y	Z
80	110	250	280

16-7	20-16	22-18	24-4	24-21	28-15	36-1
18-5	20-20	22-19	24-5	24-28	28-16	36-7
18-9	20-22	22-21	24-6	28-1	28-17	36-8
18-13	22-3	22-24	24-7	28-4	28-19	36-13
18-14	22-6	22-25	24-12	28-8	28-20	
20-7	22-12	22-29	24-14	28-9	28-21	
20-8	22-14	22-33	24-16	28-10	32-1	
20-9	22-15	22-34	24-17	28-11	32-3	
20-12	22-16	24-1	24-20	28-14	32-4	
20-14	22-17	24-3				

Insert Arrangement	Degrees			
	W	X	Y	Z
12S-3	70	145	215	290
14S-2	-	120	240	-
14S-5	-	110	-	-
14S-7	90	180	270	-
14S-9	70	145	215	290
16-9	35	110	250	325
16-10	90	180	270	-
16-11	35	110	250	325
16-13	35	110	250	325
16S-1	80	-	-	280
16S-4	35	110	250	325
16S-5	70	145	215	290
16S-6	90	180	270	-
16S-8	-	170	265	-
18-1	70	145	215	290
18-3	35	110	250	325
18-4	35	110	250	325
18-8	70	-	-	290
18-10	-	120	240	-
18-11	-	170	265	-
18-12	80	-	-	280
18-15	-	120	240	-
18-20	90	180	270	-
18-22	70	145	215	290
18-29	90	180	270	-
20-3	70	145	215	290
20-4	45	110	250	-
20-5	35	110	250	325

Insert Arrangement	Degrees			
20-6	70	145	215	290
20-15	80	-	-	280
20-17	90	180	270	-
20-18	35	110	250	325
20-19	90	180	270	-
20-21	35	110	250	325
20-23	35	110	250	325
20-2	35	110	250	325
20-27	35	110	250	325
20-29	80	-	-	280
22-1	35	110	250	325
22-2	70	145	215	290
22-4	35	110	250	325
22-5	35	110	250	325
22-8	35	110	250	325
22-9	70	145	215	290
22-10	35	110	250	325
22-11	35	110	250	325
22-13	35	110	250	325
22-20	35	110	250	325
22-22	-	110	250	-
22-23	35	-	250	-
22-27	80	-	250	280
22-28	80	-	-	280
24-2	80	-	-	280
24-9	35	110	250	325
24-10	80	-	-	280
24-11	35	110	250	325

Insert Arrangement	Degrees			
24-22	45	110	250	-
24-27	80	-	-	280
28-2	35	110	250	325
28-3	70	145	215	290
28-5	35	110	250	325
28-6	70	145	215	290
28-7	35	110	250	325
28-12	90	180	270	-
28-18	70	145	215	290
28-22	70	145	215	290
32-8	80	125	235	280
36-3	70	145	215	290
36-4	70	145	215	290
36-5	-	120	240	-
36-6	35	110	250	325
36-9	80	125	235	280
36-10	80	125	235	280
36-14	90	180	270	-
36-15	60	125	245	305

Insert Arrangements

Insert Arrangement	Service Rating	Total Cont-acts	Contact Size				
			0	4	8	12	16
10S-2	A	1					1
10SL-3	A	3					3
10SL-4	A	2					2
12S-3	A	2					2
12S-4	D	1					1
12-5	D	1					1
14S-2	Inst	4					4
14S-4	D	1					1
14S-5	Inst	5					5
14S-6	Inst	6					6
14S-7	A	3					3
14S-9	A	2					2
14S-10	Inst	4					4
14S-12	A	3					3
14-3	A	1			1		
16S-1	A	7					7
16S-3	B	1					1
16S-4	D	2					2
16S-5	A	3					3
16S-6	A	3					3
16S-8	A	5					5
16-2	E	1					1
16-7	A	3			1	2	
16-9	A	4				2	2
16-10	A	3				3	
16-11	A	2				2	
16-12	A	1		1			
16-13	A	2				2	
18-1	A/Inst	10					10
18-3	D	2				2	
18-4	D	4					4
18-5	D	3				2	1
18-6	D	1		1			
18-7	B	1			1		
18-8	A	8				1	7
18-9	Inst	7				2	5
18-10	A	4				4	
18-11	A	5				5	
18-12	A	6					6
18-13	A	4			1	3	
18-14	A	2		1			1
18-15	A	4				4	
18-16	C	1				1	
18-17	Inst	7				2	5
18-19	A	10					10
18-20	A	5					5
18-22	D	3					3
18-24	A/Inst	10					10
18-29	A	5					5
18-30	A	5					5
18-31	A	5					5
20-3	D	3				3	
20-4	D	4				4	
20-6	D	3					3
20-7	D A	8					8
20-8	Inst	6			2		4

Insert Arrangement	Service Rating	Total Cont-acts	Contact Size				
			0	4	8	12	16
20-9	D A	8				1	7
20-11	Inst	13					13
20-12	A	2		1			1
20-14	A	5			2	3	
20-15	A	7				7	
20-16	A	9				2	7
20-17	A	6				5	1
20-18	A	9				3	6
20-19	A	3			3		
20-20	A	4		1		3	
20-21	A	9				1	8
20-22	A	6			3		3
20-23	A	2			2		
20-24	A	4			2		2
20-25	Inst	13					13
20-27	A	14					14
20-29	A	17					17
20-30	Inst	13					13
20-33	A	11					11
22-1	D	2			2		
22-2	D	3			3		
22-4	A	4			2	2	
22-5	D	6				2	4
22-6	D	3			2		1
22-7	E	1	1				
22-8	E	2				2	
22-9	E	3				3	
22-10	E	4					4
22-11	B	2					2
22-12	D	5			2		3
22-13	D/A	5				4	1
22-14	A	19					19
22-15	E/A	6				5	1
22-16	A	9				3	6
22-17	D/A	9				1	8
22-18	D/A	8					8
22-19	A	14					14
22-20	A	9					9
22-21	A	3	1				2
22-22	A	4			4		
22-23	D/A	8				8	
22-24	D/A	6				2	4
22-27	D/A	9			1		8
22-28	A	7				7	
22-33	D/A	7					7
22-34	D	5				3	2
24-2	D	7				7	
24-3	D	7				2	5
24-5	A	16					16
24-6	D/A	8				8	
24-7	A	16				2	14
24-9	A	2		2			
24-10	A	7			7		
24-11	A	9			3	6	
24-12	A	5		2		3	
24-16	D/A	7			1	3	3
24-17	D	5				2	3

Insert Arrangement	Service Rating	Total Cont-acts	Contact Size				
			0	4	8	12	16
24-20	D	11				2	9
24-21	D	10			1		9
24-22	D	4			4		
24-27	E	7					7
24-28	Inst	24					24
28-1	D/A	9			3	6	
28-2	D	14				2	12
28-3	E	3			3		
28-4	E/D	9				2	7
28-5	D	5		2		1	2
28-6	D	3		3			
28-7	D	2		2			
28-8	E D A	12				2	10
28-9	D	12				6	6
28-10	D A	7		2	2	3	
28-11	A	22				4	18
28-12	A	26					26
28-13	A	26					26
28-15	A	35					35
28-16	A	20					20
28-17	B/D/A	15					15
28-18	C D A Inst	12					12
28-19	B/D/A	10				4	6
28-20	A	14				10	4
28-21	A	37					37
28-22	D	6		3			3
32-1	D/A	5	2			3	
32-3	D	9	1	2		2	4
32-4	A D	14				2	12
32-8	A	30				6	24
36-1	D	22				4	18
36-3	D	6	3			3	
36-4	D/A	3	3				
36-5	A	4	4				
36-6	A	6	2	4			
36-7	A	47				7	40
36-8	A	47				1	4
36-9	A	31		1	2	14	14
36-10	A	48					48
36-11	A	48					48
36-12	A	48					48
36-13	E/A	17				2	15
36-14	D	16			5	5	6
36-15	D/A	35					35
36-16	A	47				7	40
36-17	A	47				7	40
38-18	A	31		1	2	14	14
36-20	A	34			2	2	30
36-52	A	52					52

**Insert arrangements**

Front face of pin insert or rear of socket insert illustrated

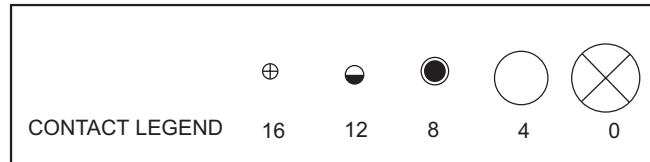

Insert arrangement	10S-2	10SL-3	10SL-4	12S-3	12S-4	12-5
Service rating	A	A	A	A	A	D
Number of contacts	1	3	2	2	1	1
Contact size	16	16	16	16	16	12
Premating contact	-	C	-	-	-	-

Insert arrangement	14S-2	14S-4	14S-5	14S-6	14S-7	14S-9
Service rating	Inst.	D	Inst.	Inst.	A	A
Number of contacts	4	1	5	6	3	2
Contact size	16	16	16	16	16	16
Premating contact	-	-	-	-	B	-

Insert arrangement	14S-10	14S-12	14-3	16S-1	16S-3	16S-4
Service rating	Inst.	A	A	A	B	D
Number of contacts	4	3	1	7	1	2
Contact size	16	16	8	16	16	16
Premating contact	-	B	-	G	-	-

Insert arrangement	16S-5	16S-6	16S-8	16-2	16-7	16-9
Service rating	A	A	A	E	A	A
Number of contacts	3	3	5	1	1 2	2 2
Contact size	16	16	16	12	8 16	12 16
Premating contact	A	B	E	-	C	-

**Insert arrangements**

Front face of pin insert or rear of socket insert illustrated

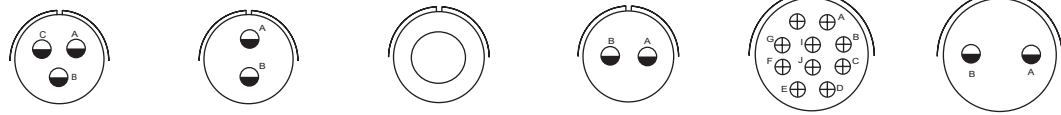
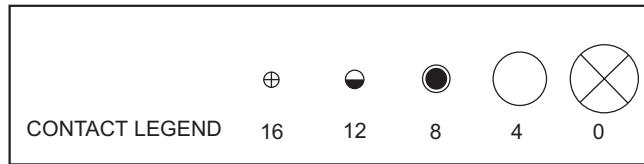

Insert arrangement	16-10	16-11	16-12	16-13	18-1	18-3
Service rating	A	A	A	A	B,C,F,G=A; Bal.=Inst.	D
Number of contacts	3	2	1	2	10	2
Contact size	12	12	4	12	16	12
Premating contact	B	-	-	-	-	-

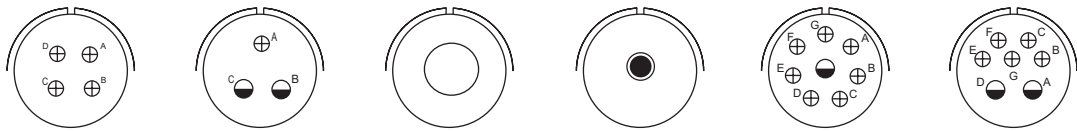

Insert arrangement	18-4	18-5	18-6	18-7	18-8	18-9
Service rating	D	D	D	B	A	Inst.
Number of contacts	4	2 1	1	1	1 7	2 5
Contact size	16	12 16	4	8	12 16	12 16
Premating contact	A	C	-	-	H	-

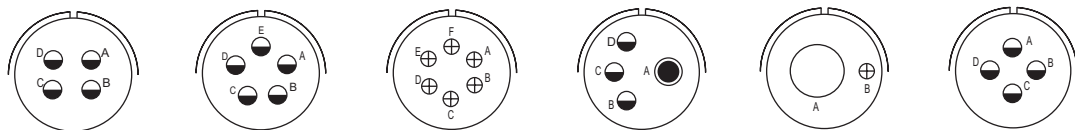

Insert arrangement	18-10	18-11	18-12	18-13	18-14	18-15
Service rating	A	A	A	A	A	A
Number of contacts	4	5	6	1 3	1 1	4
Contact size	12	12	16	8 12	4 16	12
Premating contact	D	E	C or D	A	-	-

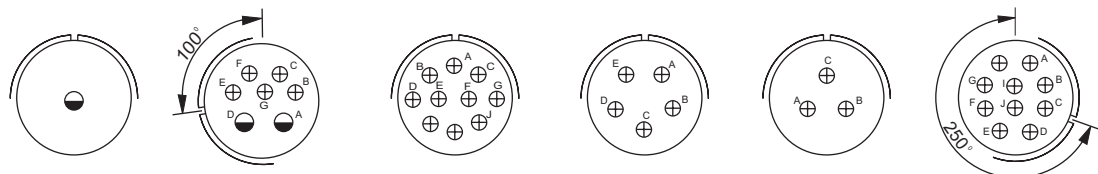

Insert arrangement	18-16	18-17	18-19	18-20	18-22	18-24
Service rating	C	Inst.	A	A	D	B,C,F,G=A; Bal.=Inst.
Number of contacts	1	2 5	10	5	3	10
Contact size	12	12 16	16	16	16	16
Premating contact	-	-	K	D	C	-

**Insert arrangements**

Front face of pin insert or rear of socket insert illustrated

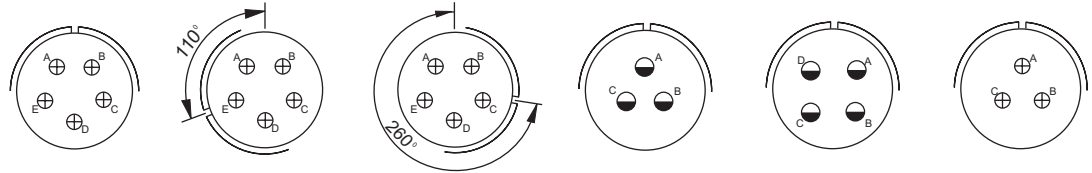
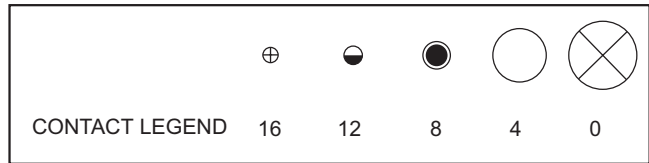

110° rotation of 18-20

260° rotation of 18-20

Insert arrangement	18-29	18-30	18-31	20-3	20-	20-6
Service rating	A	A	A	D	D	D
Number of contacts	5	5	5	4	4	3
Contact size	16	16	16	12	12	16
Premating contact	D	C	C	A	C or D	A

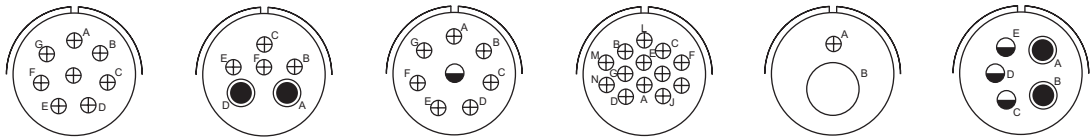

Insert arrangement	20-7	20-8	20-9	20-11	20-12	20-14
Service rating	A, B, , G=D; C, D, E, F=A	Inst.	H=D; Bal.=A	Inst.	A	A
Number of contacts	8	2 4	1 7	13	1 1	2 3
Contact size	16	8 16	12 16	16	4 16	8 12
Premating contact	A	-	H	-	-	D



Insert arrangement	20-15	20-16	20-17	20-18	20-19	20-20
Service rating	A	A	A	A	A	A
Number of contacts	7	2 7	5 1	3 6	3	1 3
Contact size	12	12 16	12 16	12 16	8	4 12
Premating contact	A or D	E	E or F	D	C	A

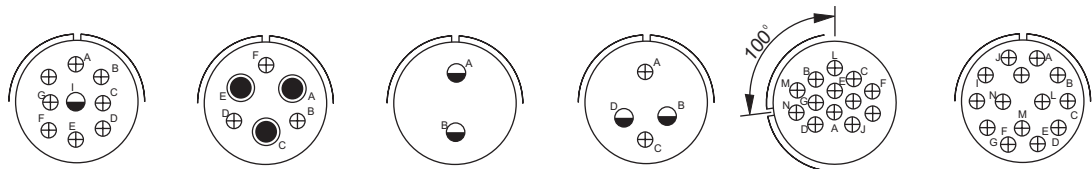

100° rotation of 20-11

Insert arrangement	20-21	20-22	20-23	20-2	20-25	20-27
Service rating	A	A	A	A	Inst.	A
Number of contacts	1 8	3 3	2	2 2	13	14
Contact size	12 16	8 16	8	8 16	16	16
Premating contact	1	-	-	-	-	M

**Insert arrangements**

Front face of pin insert or rear of socket insert illustrated

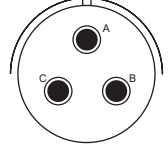
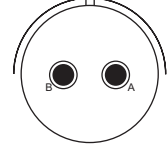
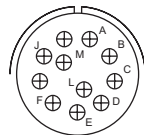
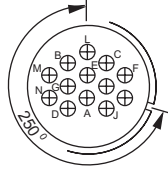
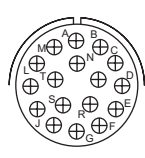
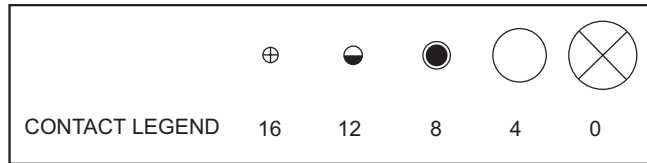

Insert arrangement  
Service rating  
Number of contacts  
Contact size  
Premating contact

20-29  
A  
17  
G  
G

250° rotation  
of 20-11

20-30  
Inst.  
13  
16  
-

20-33  
A  
11  
16  
E

22-1  
D  
2  
8  
-

22-2  
D  
3  
8  
A

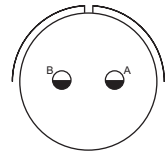
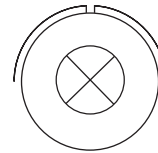
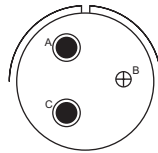
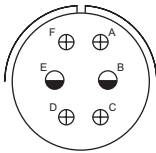
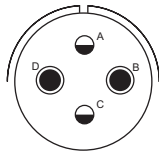

Insert arrangement  
Service rating  
Number of contacts  
Contact size  
Premating contact

22-4  
A  
2 2  
8 12  
C

22-5  
D  
2 4  
12 16  
D

22-6  
D  
2 1  
8 16  
B

22-7  
E  
1  
0  
-

22-8  
E  
2  
12  
-

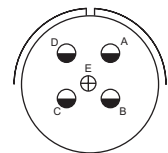
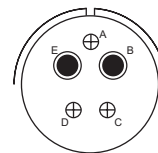
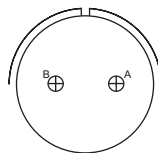
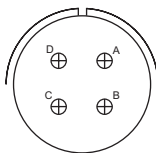
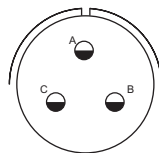

Insert arrangement  
Service rating  
Number of contacts  
Contact size  
Premating contact

22-9  
E  
3  
12  
A

22-10  
E  
4  
16  
C

22-11  
B  
2  
16  
-

22-12  
D  
2 3  
8 16  
A

22-13  
E=D; A, B, C, D=A  
4 1  
12 16  
E

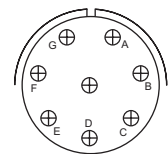
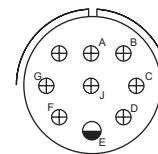
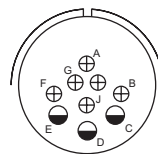
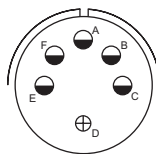
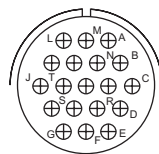

Insert arrangement  
Service rating  
Number of contacts  
Contact size  
Premating contact

22-14  
A  
19  
16  
A

22-15  
D=E; A, B, C, E, F=A  
5 1  
12 16  
D

22-16  
A  
3 6  
12 16  
D

22-17  
A=D; Bal.=A  
1 8  
12 16  
E

22-18  
A, B, F, G, H=D; C, D, E=A  
8  
16  
D

**Insert arrangements**

Front face of pin insert or rear of socket insert illustrated

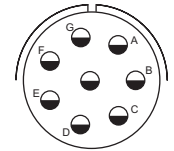
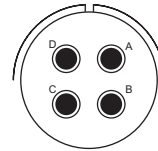
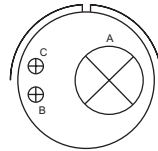
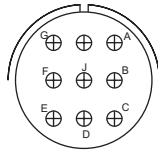
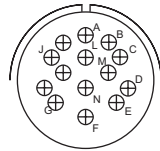
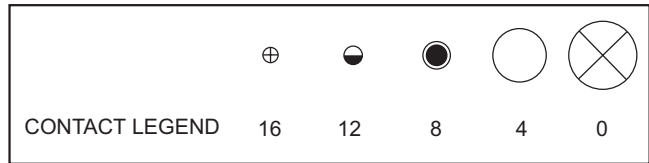

Insert arrangement	22-19	22-20	22-21	22-22	22-23
Service rating	A	A	A	A	H=D; Bal.=A
Number of contacts	1	9	1 2	4	8
Contact size	16	16	0 16	8	12
Premating contact	F	D	-	C or D	A or D

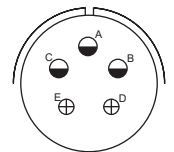
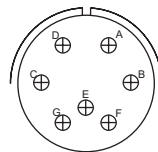
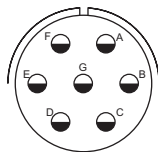
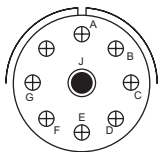
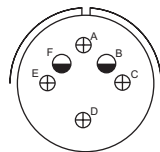

Insert arrangement	22-2	22-27	22-28	22-23	22-34
Service rating	C,D,E=D; A,B,F=A	J=D; Bal.=A	A	A,B,C,D=D; E,F,G=A	D
Number of contacts	2 4	1 8	7	7	3 2
Contact size	12 16	8 16	12	16	12 16
Premating contact	D	-	G	E	E

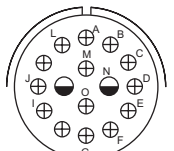
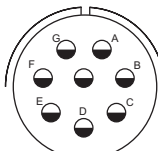
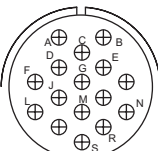
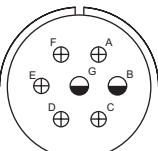
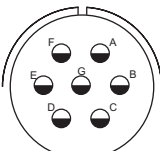

Insert arrangement	24-2	24-3	24-5	24-6	24-7
Service rating	D	D	A	A,G,H=D; Bal.=A	A
Number of contacts	7	2 5	16	8	2 14
Contact size	12	12 16	16	12	12 16
Premating contact	A	D	S	D	G

**Insert arrangements**

Front face of pin insert or rear of socket insert illustrated

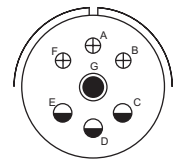
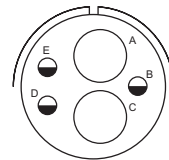
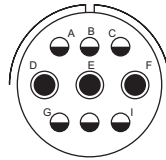
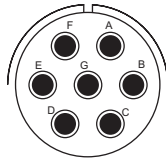
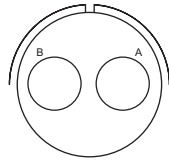
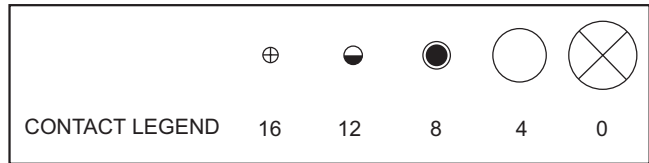

Insert arrangement	24-19	24-10	24-11	24-12	24-16
Service rating	A	A	A	A	A,B,F,G=D;C,D,E=A
Number of contacts	2	7	3 6	2 3	1 3 3
Contact size	4	8	8 12	4 12	8 12 16
Premating contact	-	D or E or G	E	-	G

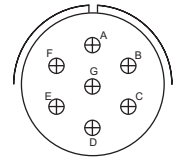
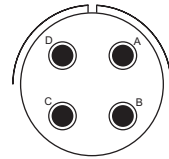
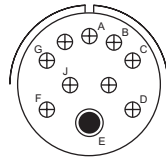
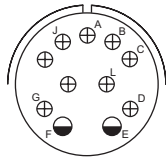
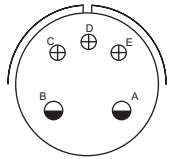

Insert arrangement	24-17	24-20	24-21	24-22	24-27
Service rating	D	D	D	D	E
Number of contacts	2 3	2 9	1 9	4	7
Contact size	12 16	12 16	8 16	8	16
Premating contact	D	A	E	D	D

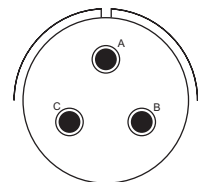
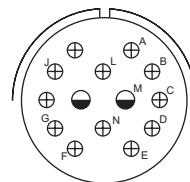
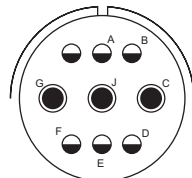
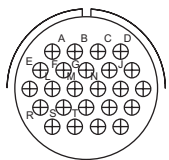

Insert arrangement	24-28	28-1	28-2	28-3
Service rating	Inst.	A,J,E=D;Bal.=A	D	E
Number of contacts	24	3 6	2 12	3
Contact size	16	8 12	12 16	8
Premating contact	-	E	E	A



**Insert arrangements**

Front face of pin insert or rear of socket insert illustrated

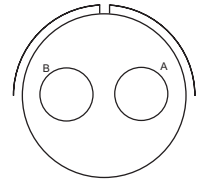
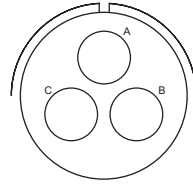
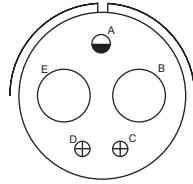
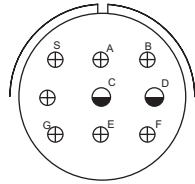
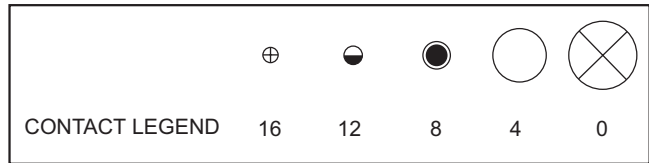

Insert arrangement  
Service rating  
Number of contacts  
Contact size  
Premating contact

28-4  
G,S,P=E;Bal.=D  
2 7  
12 16  
E

28-5  
D  
2 1 2  
4 12 16  
-

28-6  
D  
3  
4  
A

28-7  
D  
2  
4  
-

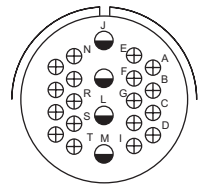
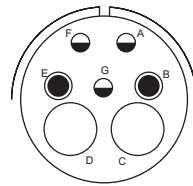
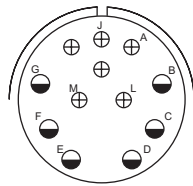
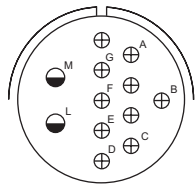

Insert arrangement  
Service rating  
Number of contacts  
Contact size  
Premating contact

28-8  
L,M=E;B=D;Bal.=A  
2 10  
12 16  
D

28-9  
D  
6 6  
12 16  
E

28-10  
G=D;Bal.=A  
2 2 3  
4 8 12  
G

28-11  
A  
4 18  
12 16  
M

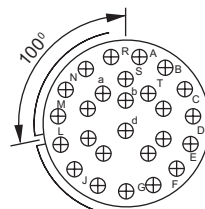
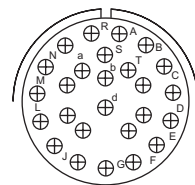

100° rotation  
of 28-12

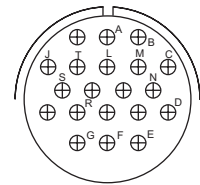
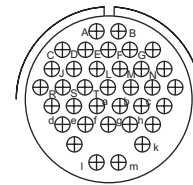

Insert arrangement  
Service rating  
Number of contacts  
Contact size  
Premating contact

28-12  
A  
26  
16  
H

28-13  
A  
26  
16  
H

28-15  
A  
35  
16  
M

28-16  
A  
20  
16  
F

**Insert arrangements**

Front face of pin insert or rear of socket insert illustrated

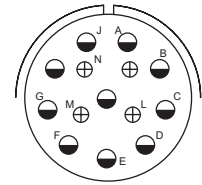
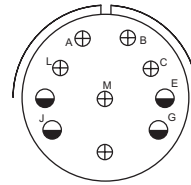
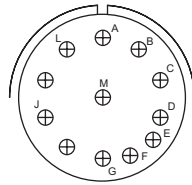
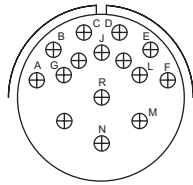
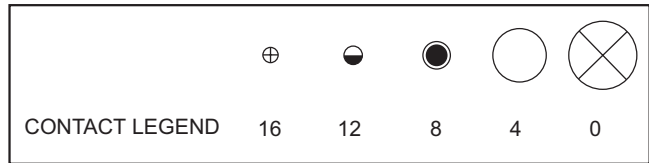

Insert arrangement  
Service rating  
Number of contacts  
Contact size  
Premating contact

28-17  
R=B;M,N,P=D;AtoL=A  
15  
16  
N

28-18  
M=C;G,H,J,K,L=D;A,B=ABal.=Inst.  
12  
16  
-

28-19  
H,M=B;A,B=D;Bal.=A  
4 6  
12 16  
H

28-20  
A  
10 4  
12 16  
E

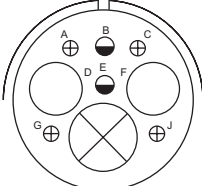
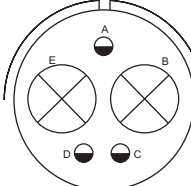
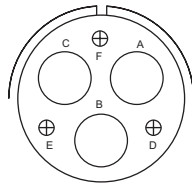
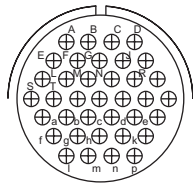

Insert arrangement  
Service rating  
Number of contacts  
Contact size  
Premating contact

28-21  
A  
37  
16  
A

28-22  
D  
3 3  
4 16  
-

32-1  
A=E;B,C,D,E=A  
2 3  
0 12  
-

32-3  
D  
1 2 2 4  
0 4 12 16  
-

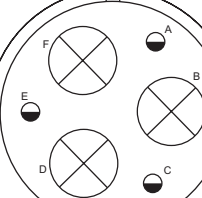
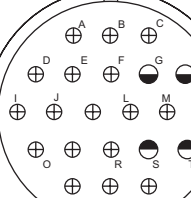
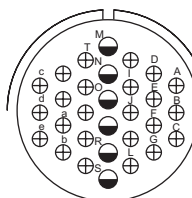
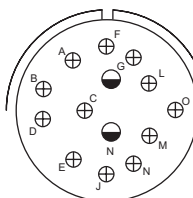

Insert arrangement  
Service rating  
Number of contacts  
Contact size  
Premating contact

32-4  
F,J,K,N=ABal.=D  
2 12  
12 16  
-

32-8  
A  
6 24  
12 16  
S

36-1  
D  
4 18  
12 16  
-

36-3  
D  
3 3  
0 12  
-

**Insert arrangements**

Front face of pin insert or rear of socket insert illustrated

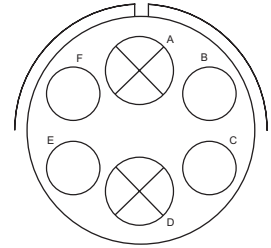
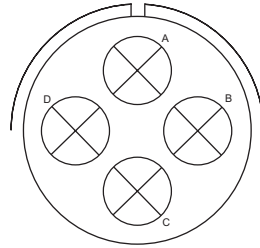
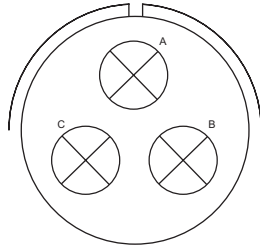
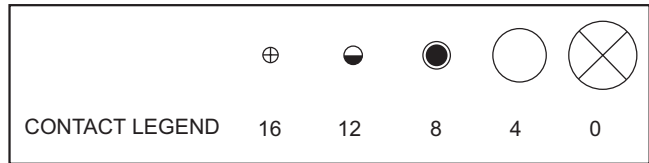

Insert arrangement  
Service rating  
Number of contacts  
Contact size  
Premating contact

36-4  
A=D;B,C=A  
3  
0  
-

36-5  
A  
4  
0  
-

36-6  
A  
2 4  
0 4  
-

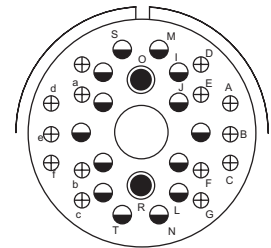
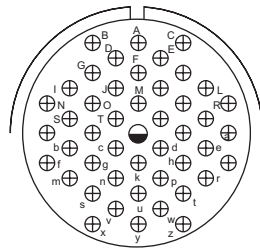
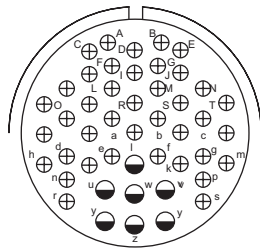

Insert arrangement  
Service rating  
Number of contacts  
Contact size  
Premating contact

36-7  
A  
7 0  
12 16  
x or y

36-8  
A  
1 6  
12 16

36-9  
A  
1 2 1 1  
8 12 16

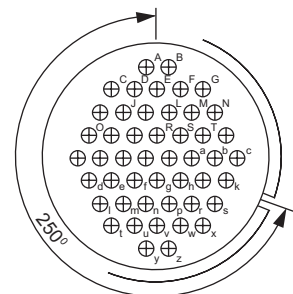
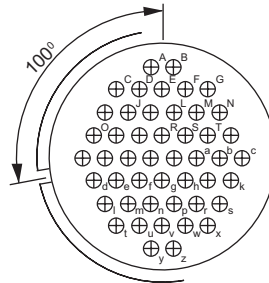
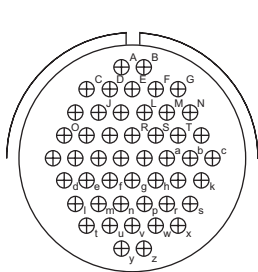

Insert arrangement  
Service rating  
Number of contacts  
Contact size  
Premating contact

36-10  
A  
8  
16  
A

100° rotation  
of 36-10  
36-11  
A  
8  
16  
A

250° rotation  
of 36-10  
36-12  
A  
8  
16  
A

**Insert arrangements**

Front face of pin insert or rear of socket insert illustrated

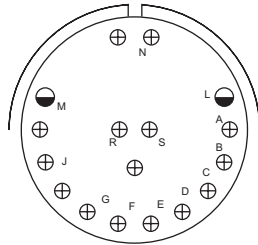
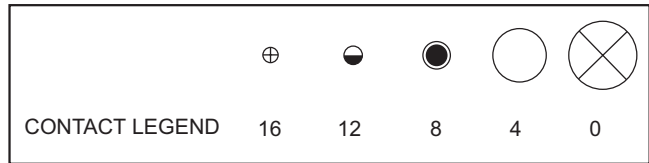

36-13  
Service rating N,P,Q=E;Bal.=A  
Number of contacts 2 15  
Contact size 12 16  
Premating contact -

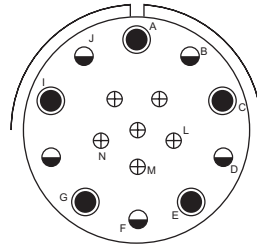

36-14  
Service rating D  
Number of contacts 5 5 6  
Contact size 8 12 16  
Premating contact -

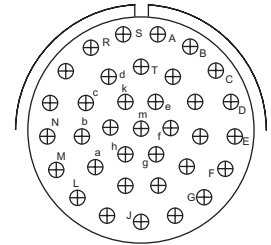

36-15  
Service rating M=D;Bal=A  
Number of contacts 35  
Contact size 16  
Premating contact J

Insert arrangement  
Service rating  
Number of contacts  
Contact size  
Premating contact

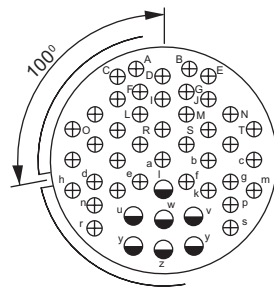

100° rotation of 36-7

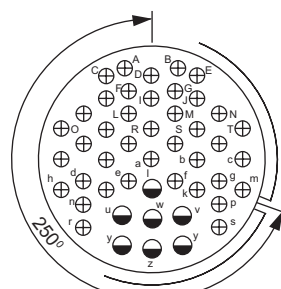

250° rotation of 36-7

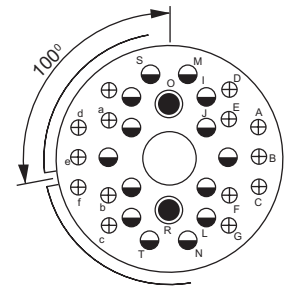

100° rotation of 36-9

Insert arrangement  
Service rating  
Number of contacts  
Contact size  
Premating contact

36-16  
Service rating A  
Number of contacts 7 4 0  
Contact size 12 16  
Premating contact x or y

36-17  
Service rating A  
Number of contacts 7 4 0  
Contact size 12 16  
Premating contact x or y

36-18  
Service rating A  
Number of contacts 1 2 1 4 1 6  
Contact size 4 8 12 16  
Premating contact -

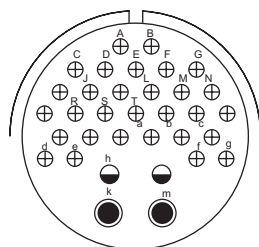

36-20  
Service rating A  
Number of contacts 2 2 30  
Contact size 8 12 16  
Premating contact k

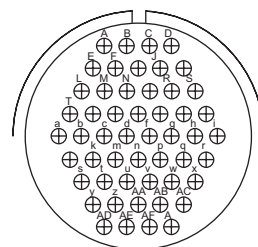

36-52  
Service rating A  
Number of contacts 52  
Contact size 16  
Premating contact -

Insert arrangement  
Service rating  
Number of contacts  
Contact size  
Premating contact

**Shell types**  
**Wall mounting receptacle**  
**MS-3100 97-3100 MS-4100 97-4100**

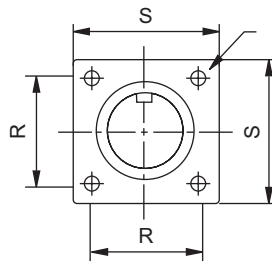
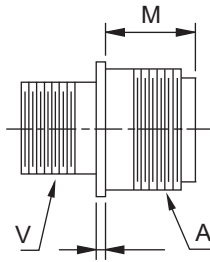

MOUNTING HOLES  
 4.39 DIA. FOR SIZE 32 AND 36  
 3.73 DIA. FOR SIZE 2 AND 28  
 3.05 DIA. FOR ALL OTHER SIZES

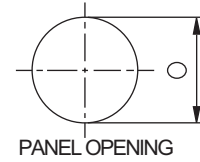

All dimensions are in mm

Connector Size	A Thread in inches		M	O	R	S	Thread in inches
10SL	5/8-24 UNEF	1.98	14.29	20.62	18.25	25.68	5/8-24 NEF
12S	3/4-20 UNEF	1.98	14.29	20.62	20.64	27.76	11/16-24NEF
12	3/4-20 UNEF	1.98	19.05	20.62	20.64	27.76	11/16-24NEF
14S	7/8-20 UNEF	1.98	14.29	23.82	23.02	30.43	3/4 -20 U NEF
14	7/8-20 UNEF	1.98	19.05	23.82	23.02	30.43	3/4-20 UNEF
16S	1-20 UNEF	1.98	14.29	26.97	24.61	32.82	7/8-20 UNEF
16	1-20 UNEF	3.17	19.05	26.97	24.61	32.82	7/8-20 UNEF
18	1 1/8 - 18 UN EF	3.17	19.05	30.17	26.99	35.07	1-20 UNEF
20	1 1/4 - 18 UN EF	3.17	19.05	33.32	29.37	38.38	1 1/8-2 NS
22	1 3/8 - 18 UN EF	3.17	19.05	36.52	31.75	41.55	1 1/4 -18 NEF
24	1 1/2 - 18 UN EF	3.17	20.6	39.67	34.92	44.70	1 3/8-18 NEF
28	1 3/4 - 18 UN S	3.17	20.6	6.02	39.69	51.08	1 5/8-18 NEF
32	2.00-18 NS	3.17	22.25	53.0	44.45	57.15	1 29/32-18 NS
36	2 1/4 - 16 UN	3.17	22.22	58.72	9.21	63.78	2 1/16-20 UNS

**Cable connecting receptacle**  
**MS-3101 97-3101 MS-4101 97-4101**

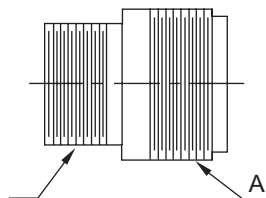

All dimensions are in mm

Connector Size	A Thread in inches	Thread in inches
10SL	5/8-2 UNEF	5/8-24 NEF
12S	3/4 -20 UNEF	11/16-2 NEF
12	3 -20 U NEF	11/16-2 NEF
14S	7/8-20 UNEF	3/4 -20 UNEF
14	7/8-20 U NEF	3/4 -20 UNEF
16S	1-20 UNEF	7/8-20 UNEF
16	1-20 UNEF	7 8-20 UNEF
18	1 1/8-18 UNEF	1-20 NEF
20	1 1/4 -18 UNEF	1 1/8-2 NS
22	1 3/8-18 UNEF	1 1/4 -18 NEF
24	1 1/2-18 UNEF	1 3/8-18 NEF
28	1 3/4 -18 UNS	1 5/8-18 NEF
32	2-18 UNS	1 29/32-18 NS
36	2 1/4 -16 UN	2 1/16-20 UNS

**Shell types**  
**Box mounting receptacle**  
**MS-3102 97-3102 MS-4102 97-4102**

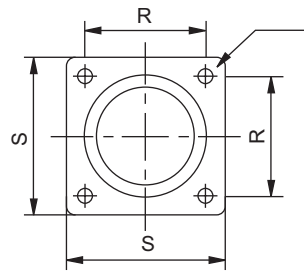
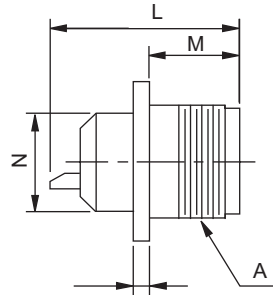

MOUNTING HOLES  
 4 .39 DIA. FOR SIZE 32 AND 36  
 3.73 DIA. FOR SIZE 24 AND 28  
 3.05 DIA. FOR ALL OTHER SIZES

All dimensions are in mm

Connector Size	A Thread in inches		L	M	N	R	S
10SL	5/8-24UNEF	1.98	30.18	13.89	15.87	18.25	25.68
12S	3/4-20UNEF	1.98	30.18	14.28	17.46	20.64	28.04
12	3/4-20UNEF	1.98	41.28	19.05	17.46	20.64	28.04
14S	7/8-20UNEF	1.98	30.18	14.28	19.05	23.02	30.43
14	7/8-20UNEF	1.98	41.28	19.05	19.05	23.02	30.43
16S	1-20 NEF	1.98	30.18	14.28	22.22	24.61	32.82
16	1-20 NEF	3.17	41.28	19.05	22.22	24.61	32.82
18	1 1/8 - 18 UNEF	3.17	49.28	19.05	25.40	26.99	35.08
20	1 1/4 - 18 UNEF	3.17	49.28	19.05	28.57	29.37	38.38
22	1 3/8 - 18 UNEF	3.17	49.28	19.05	31.75	31.75	41.55
24	1 1/2 - 18 UNEF	3.17	49.28	20.64	3.92	34.92	44.73
28	1 3/4 - 18 UNS	3.17	49.28	20.64	1.27	39.69	51.08
32	2-18UNS	3.17	49.28	22.22	8.26	44.45	57.15
36	2 1/4 - 16 UN	3.17	49.28	22.22	53.97	49.21	63.78

**Straight plug**  
**MS-3106 97-3106 MS-4106 97-4106**

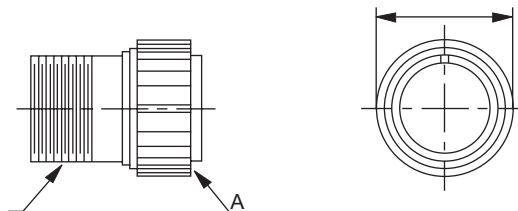

All dimensions are in mm

Connector Size	A Thread in inches	Q max	V Thread in inches
10SL	5/8-24UNEF	19.05	5/8-24NEF
12S	3/4-20UNEF	19.84	11/16-24NEF
12	3/4-20UNEF	19.84	11/16-24NEF
14S	7/8-20UNEF	22.22	3/4-20UNEF
14	7/8-20UNEF	22.22	3/4-20UNEF
16S	1-20UNEF	25.40	7/8-20UNEF
16	1-20UNEF	25.40	7/8-20UNEF
18	1 1/8 - 18 UNEF	28.57	1-20 UNEF
20	1 1/4 - 18 UNEF	31.75	1 1/8 - 24 NS
22	1 3/8 - 18 UNEF	34.92	1 1/4 - 18 NEF
24	1 1/2 - 18 UNEF	38.10	1 3/8 - 18 NEF
28	1 3/4 - 18 UNS	44.55	1 5/8 - 18 NEF
32	2-18UNS	51.75	1 29/32 - 18 NS
36	2 1/4 - 16 UN	57.15	2 1/16 - 20 UNS

Note - Both versions, straight and diamond knurling available on coupling ring. For details, contact factory.

**Shell types**  
**Rightangle plug**  
**MS-3108 97-3108 MS-4108 97-4108**

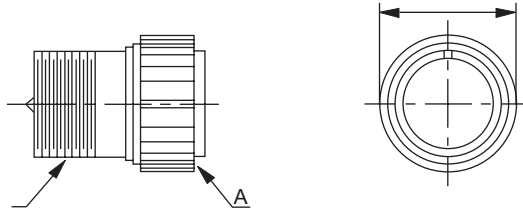

All dimensions are in mm

Connector Size	A Thread in inches	max	Thread in inches
10SL	5/8-24UNEF	19.05	5/8-24NEF
12S	3/4-20UNEF	19.84	11 16-2 NEF
12	3/4-20UNEF	19.84	11 16-2 NEF
14S	7/8-20UNEF	22.22	3 -20 NEF
14	7/8-20UNEF	22.22	3 -20 NEF
16S	1-20UNEF	25.40	7 8-20 NEF
16	1-20UNEF	25.40	7 8-20 NEF
18	1 1/8 - 18 UNEF	28.57	1-20 NEF
20	1 1/4 - 18 UNEF	31.75	1 1/8-2 NS
22	1 3/8 - 18 UNEF	33.92	1 1 -18 NEF
22	1 1/2 - 18 UNEF	38.10	1 3/8-18 NEF
28	1 3/4 - 18 UNS	44.45	1 5/8-18 NEF
32	2-18UNS	51.75	1 29/32-18 NS
36	2 1/4 - 16 NS	57.15	2 1/16-20 NS

Note - Both versions, straight and diamond knurling available on coupling ring. For details, contact factory.

**Shell types**

**Box mounting receptacle  
97B-3100 97B-4100 MOUNTING HOLES**

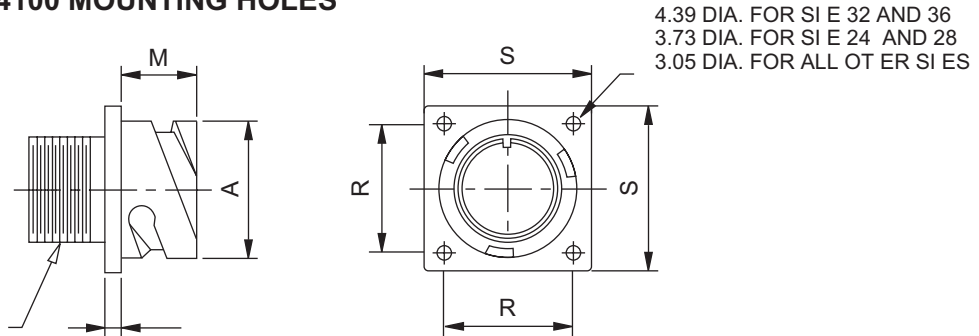

All dimensions are in mm

Connector Size	A		M	R	S	Thread in inches
10SL	18.2	2.8	14.2	18.2	25.4	5/8-2 NEF
14S	24.6	3.2	14.2	23.0	30.0	3/4 -20 NEF
16S	27.4	3.2	14.2	24.6	32.5	7/8-20 NEF
16	27.4	3.2	19.0	24.6	32.5	7/8-20 NEF
18	30.8	4.0	19.0	27.0	35.0	1-20 NEF
20	34.2	4.0	19.0	29.4	38.0	1 1/8-2 NS
22	37.4	4.0	19.0	31.8	41.0	1 1 -18 NEF
24	40.9	4.0	20.6	34.9	44.5	1 3/8-18 NEF
28	46.7	4.0	20.6	39.7	50.8	1 5/8-18 NEF
32	53.4	4.0	22.2	44.5	57.0	1 29/32-18 NS
36	59.6	4.0	22.2	49.2	63.5	2 1/16-20 NS

**Cable connecting receptacle  
97B-3101 97B-4101**

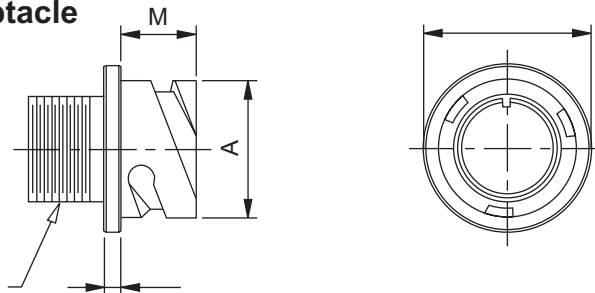

All dimensions are in mm

Connector Size	A		M	Thread in inches
10SL	18.2	2.8	14.2	5/8-2 NEF
14S	24.6	3.2	14.2	3/4 -20 NEF
16S	27.4	3.2	14.2	7/8-20 NEF
16	27.4	3.2	19.0	7/8-20 NEF
18	30.8	4.0	19.0	1-20 NEF
20	34.2	4.0	19.0	1 1/8-2 NS
22	37.4	4.0	19.0	1 1 -18 NEF
24	40.9	4.0	20.6	1 3/8-18 NEF
28	46.7	4.0	20.6	1 5/8-18 NEF
32	53.4	4.0	22.2	1 29/32-18 NS
36	59.6	4.0	22.2	2 1/16-20 NS



**Shell types**

**Front box mounting receptacle  
97B-3102 97B-4102 MOUNTING HOLES**

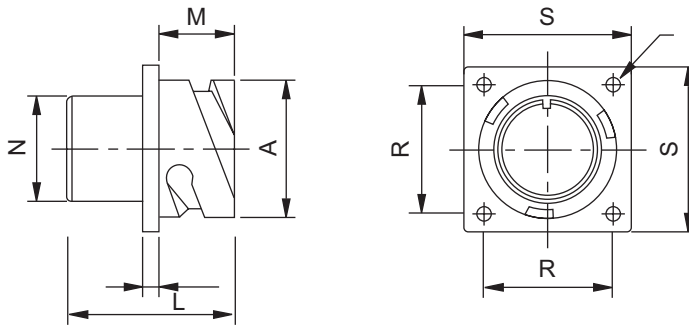

4.39 DIA. FOR SIZE 32 AND 36  
3.73 DIA. FOR SIZE 2 AND 28  
3.05 DIA. FOR ALL OTHER SIZES

All dimensions are in mm

Connector Size	A		M	R	S	N max	L max
10SL	18.2	2.8	14.2	18.2	25.4	15.9	24.7
14S	24.6	3.2	14.2	23.0	30.0	19.2	24.7
16S	27.4	3.2	14.2	24.6	32.5	22.4	24.7
16	27.4	3.2	19.0	24.6	32.5	22.4	33.8
18	30.8	4.0	19.0	27.0	35.0	25.6	34.5
20	34.2	4.0	19.0	29.4	38.0	29.0	34.5
22	37.4	4.0	19.0	31.8	41.0	32.2	34.5
24	40.9	4.0	20.6	34.9	44.5	35.3	35.7
28	46.7	4.0	20.6	39.7	50.8	41.4	35.7
32	53.4	4.0	22.2	44.5	57.0	47.8	37.3
36	59.6	4.0	22.2	49.2	63.5	52.4	37.3

**Back box mounting receptacle  
97B-3103 97B-4103 MOUNTING HOLES**

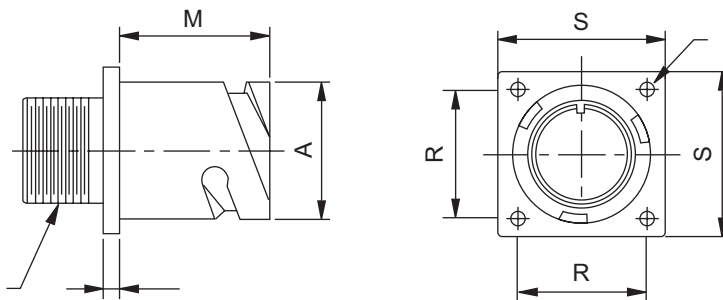

4.39 DIA. FOR SIZE 32 AND 36  
3.73 DIA. FOR SIZE 2 AND 28  
3.05 DIA. FOR ALL OTHER SIZES

All dimensions are in mm

Connector Size	A		M	R	S	Thread in inches
10SL	18.2	2.8	18.2	18.2	25.4	5/8-2 NEF
14S	24.6	3.2	18.2	23.0	30.0	3/4 -20 NEF
16S	27.4	3.2	18.2	24.6	32.5	7/8-20 NEF
16	27.4	3.2	21.5	24.6	32.5	7/8-20 NEF
18	30.8	4.0	23.05	27.0	35.0	1-20 NEF
20	34.2	4.0	23.05	29.4	38.0	1 1/8-2 NS
22	37.4	4.0	23.05	31.8	41.0	1 1/4 -18 NEF
24	40.9	4.0	23.05	34.9	44.5	1 3/8-18 NEF
28	46.7	4.0	24.05	39.7	50.8	1 5/8-18 NEF
32	53.4	4.0	24.05	44.5	57.0	1 29/32-18 NS
36	59.6	4.0	24.05	49.2	63.5	2 1/16-20 NS

Shell types

Mounting receptacle  
- 102 - 102

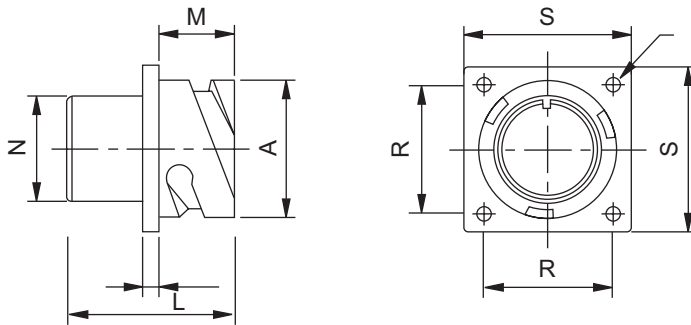

Mounting holes  
4.39 DIA. FOR SIZE 32 AND 36  
3.73 DIA. FOR SIZE 2 AND 28  
3.05 DIA. FOR ALL OTHER SIZES

All dimensions are in mm

Connector Size	A		M	R	S	N max	L max
10SL	18.2	2.8	1.2	18.2	25.	15.9	2.7
1 S	2.6	3.2	1.2	23.0	30.0	19.2	2.7
16S	27.	3.2	1.2	2.6	32.5	22.	2.7
16	27.	3.2	19.0	2.6	32.5	22.	33.8
18	30.8	.0	19.0	27.0	35.0	25.6	3.5
20	3.2	.0	19.0	29.	38.0	29.0	3.5
22	37.	.0	19.0	31.8	1.0	32.2	3.5
2	0.9	.0	20.6	3.9	.5	35.3	35.7
28	6.7	.0	20.6	39.7	50.8	1.	35.7
32	53.	.0	22.2	.5	57.0	7.8	37.3
36	59.6	.0	22.2	9.2	63.5	52.	37.3

Mounting receptacle  
- 10 - 10

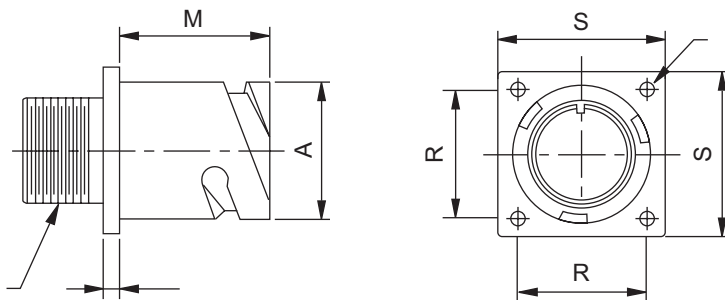

Mounting holes  
.39 DIA. FOR SIZE 32 AND 36  
3.73 DIA. FOR SIZE 2 AND 28  
3.05 DIA. FOR ALL OTHER SIZES

All dimensions are in mm

Connector Size	A		M	R	S	Thread in inches
10SL	18.2	2.8	18.2	18.2	25.	5/8-2 NEF
1 S	2.6	3.2	18.2	23.0	30.0	3/8-20 NEF
16S	27.	3.2	18.2	2.6	32.5	7/8-20 NEF
16	27.	3.2	21.5	2.6	32.5	7/8-20 NEF
18	30.8	.0	23.05	27.0	35.0	1-20 NEF
20	3.2	.0	23.05	29.	38.0	1 1/8-2 NS
22	37.	.0	23.05	31.8	1.0	1 1/8-18 NEF
2	0.9	.0	23.05	3.9	.5	1 3/8-18 NEF
28	6.7	.0	2.05	39.7	50.8	1 5/8-18 NEF
32	53.	.0	2.05	.5	57.0	1 29/32-18 NS
36	59.6	.0	2.05	9.2	63.5	2 1/16-20 NS

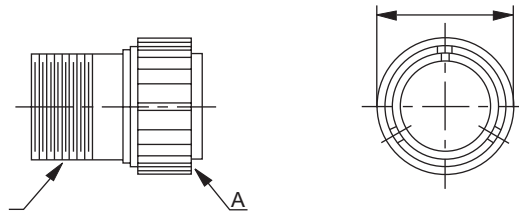
**Shell types****Straight plug****97B-3106 97B-4106**

All dimensions are in mm

Connector Size	max	Thread in inches
10SL	22.8	5/8-2 NEF
14S	29.2	3/4 -20 NEF
16S	32.0	7/8-20 NEF
16	32.0	7/8-20 NEF
18	36.5	1-20 NEF
20	39.9	1 1/8-2 NS
22	43.1	1 1/4 -18 NEF
24	46.6	1 3/8-18 NEF
28	53.4	1 5/8-18 NEF
32	60.1	1 29/32-18 NS
36	66.3	2 1/16-20 NS

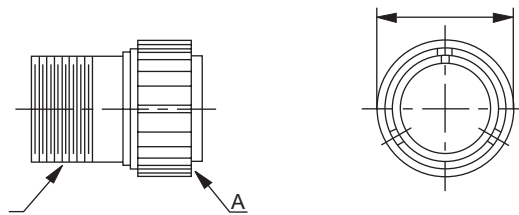
**Right angle plug****- 108 - 108**

All dimensions are in mm

Connector Size	max	Thread in inches
10SL	22.8	5/8-2 NEF
14S	29.2	3/4 -20 NEF
16S	32.0	7/8-20 NEF
16	32.0	7/8-20 NEF
18	36.5	1-20 NEF
20	39.9	1 1/8-2 NS
22	43.1	1 1/4 -18 NEF
24	46.6	1 3/8-18 NEF
28	53.4	1 5/8-18 NEF
32	60.1	1 29/32-18 NS
36	66.3	2 1/16-20 NS

Note - Both versions, straight and diamond knurling available on coupling ring. For details, contact factory.

## Back accessories

### Solid backshell with out grommet and sleeve

#### Class A

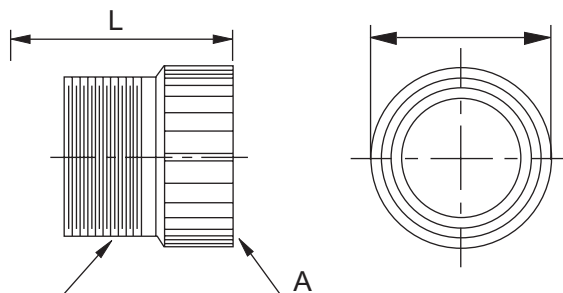

All dimensions are in mm

Connector Size	A Thread in inches	L max for MS 97	L max for 97B	max	Thread in inches
10SL	5/8-2 NEF	32.5	37.60	19.05	5/8-2 NEF
12S	11/16-2 NEF	37.31	---	19.8	5/8-2 NEF
12	11/16-2 NEF	46.83	---	19.8	5/8-2 NEF
14S	3/4 -20 NEF	36.51	37.6	22.22	3/4 -20 NEF
14	3/4 -20 NEF	46.83	---	22.22	3/4 -20 NEF
16S	7/8-20 NEF	37.70	38.83	25.0	7/8-20 NEF
16	7 8-20 NEF	48.02	8.00	25.0	7/8-20 NEF
18	1-20 NEF	50.80	51.58	28.57	1-20 NEF
20	1 1/8-2 NS	53.97	54.75	31.75	1 3/16-18 NEF
22	1 1/4 -18 NEF	53.97	54.75	34.92	1 3/16-18 NEF
24	1 3/8-18 NEF	57.15	57.94	38.10	1 7/16-18 NEF
28	1 5/8-18 NEF	57.15	57.94	44.45	1 7/16-18 NEF
32	1 29/32-18 NS	59.0	59.78	51.75	1 3/4 -18 NS
36	2 1/26-20 NS	60.32	61.13	57.15	2-18 NS

### Solid backshell with grommet and sleeve

#### Class R

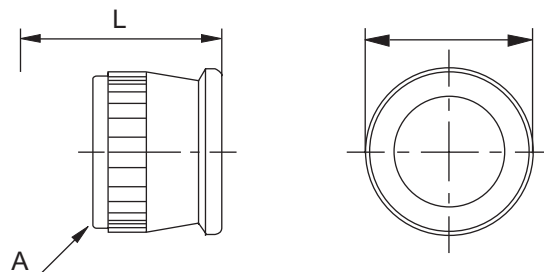

All dimensions are in mm

Connector Size	A Thread class 2B in inches	L max for MS 97	L max for 97B	max
10SL	5/8-2 NEF	47	6.00	21.50
12S	11/16-2 NEF	4	7	20.35
12	11/16-2 NEF	55	---	20.35
14S	3/4 -20 NEF	4	6.0	23.40
14	3/4 -20 NEF	55	---	23.40
16S	7/8-20 NEF	7	46.0	26.71
16	7/8-20 NEF	55	55.40	26.71
18	1-20 NEF	57	57.40	29.50
20	1 1/8-2 NS	57	57.40	35.70
22	1 1/4 -18 NEF	57	57.40	35.85
24	1 3/8-18 NEF	57	57.40	44.40
28	1 5/8-18 NEF	57	57.40	45.08
32	1 29/32-18 NS	58.25	58.10	52.36
36	2 1/16-20 NS	58.25	58.10	56.81

Note - Both versions, straight and diamond knurling available on back accessories. For details, contact factory.

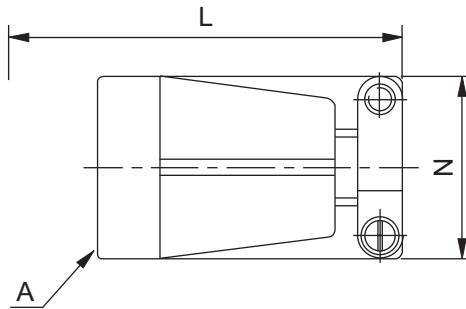
**Back accessories****Strain relief backshell with grommet and sleeve****Class E and F**

All dimensions are in mm

Connector Size	A Thread class 2B in inches	L max for MS 97	L max for 97B	N max
10SL	5/8-2 NEF	54.07	59.10	21.97
12S	11/16-2 NEF	54.07	---	21.97
14S	3/4 -20 NEF	55.90	61.34	25.15
16S	7/8-20 NEF	55.90	62.86	28.45
16	7/8-20 NEF	64.41		28.45
18	1-20 NEF	65.94	71.10	30.76
20	1 1/8-2 NS	67.41	72.55	37.29
22	1 1/4 -18 NEF	67.41	72.55	37.29
24	1 3/8-18 NEF	73.28	76.82	44.45
28	1 5/8-18 NEF	73.28	77.82	44.45
32	1 29/32-18 NS	74.75		52.22
36	2 1/26-20 NS	74.75	77.6	57.15

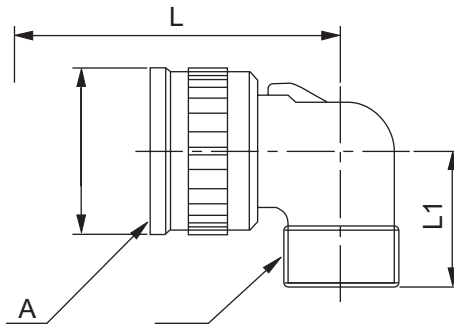
**Right angle backshell with or without grommet****Class A F and R**

All dimensions are in mm

Connector Size	A Thread class 2B in inches	L max for MS 97	L max for 97B	L1 max	max	Thread in inches
10SL	5 8-2 NEF	37.60	5.00	25.00	22.22	5/8-2 NEF
12S	11 16-2 NEF	37.80	---	25.00	25.40	5/8-2 NEF
12	11 16-2 NEF	7.30	---	25.00	25.40	5/8-2 NEF
1 S	3 -20 NEF	39.0	7.00	27.00	28.57	3/4 -20 NEF
1	3 -20 NEF	8.90	---	27.00	28.57	3/4 -20 NEF
16S	7 8-20 NEF	2.60	8.00	28.00	31.75	7/8-20 NEF
16	7 8-20 NEF	52.10	57.00	28.00	31.75	7/8-20 NEF
18	1-20 NEF	53.70	58.00	31.00	34.13	1-20 NEF
20	1 1 8-2 NS	58.80	61.00	3.00	37.30	1 3/16-18 NEF
22	1 1 -18 NEF	58.80	61.00	3.00	40.48	1 3/16-18 NEF
2	1 3 8-18 NEF	63.60	66.00	37.00	43.66	1 7/16-18 NEF
28	1 5 8-18 NEF	63.60	66.00	39.00	50.00	1 7/16-18 NEF
32	1 29 32-18 NS	69.60	72.00	5.00	56.50	1 3/4 -18 NS
36	2 1 26-20 NS	72.80	75.00	8.00	62.71	2-18 NS

Note - Both versions, straight and diamond knurling available on back accessories. For details, contact factory.

**Back accessories**

**Cable clamp**

**MS-3057**

Use MS-3420 sleeves

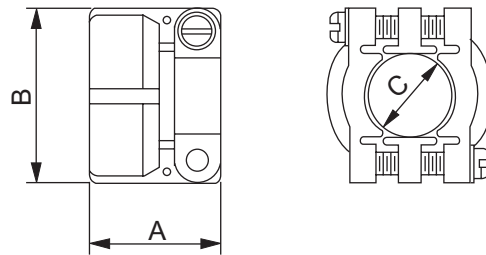

All dimensions are in mm

art number	Shell size	Max OD of cable	A	B	C	Thread in inches
MS-3057-4A	10SL, 12S	7.94	20.90	21.39	7.94	5/8-2
MS-3057-6A	14, 14S	11.11	21.59	25.27	11.11	3/4 -20
MS-3057-8A	16, 16S	14.29	23.37	28.5	14.29	7/8-20
MS-3057-10A	18	15.87	23.37	30.89	15.87	1-20
MS-3057-12A	20,22	19.05	23.54	35.64	19.05	1 3/16-18
MS-3057-16A	24,28	23.81	25.78	2.75	23.81	1 7/16-18
MS-3057-20A	32	31.70	28.00	51.00	31.70	1 3/4 -18
MS-3057-24A	36	34.92	29.36	57.02	34.92	2-18

**Neoprene sleeve**

**MS-3420**

Rubber bushing. protects wire bundles and un jacketed cables from possible damage by cable clamp.

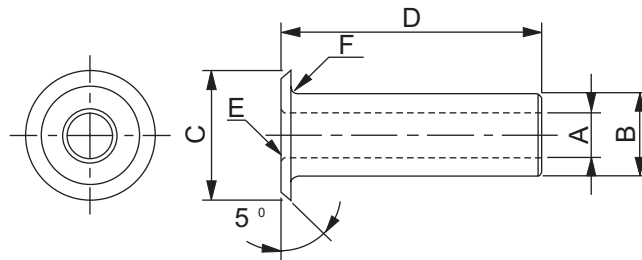

All dimensions are in mm

art number	A	B	C	D	E Rad in inches	F Rad in inches
MS-3420-3	3.30	5.33	9.50	73.02	1/32	1/32
MS-3420-4	5.59	7.67	12.70	69.85	1/32	1/32
MS-3420-6	7.92	10.8	15.59	66.67	1/32	1/16
MS-3420-8	11.10	1.02	18.77	63.50	1/16	1/16
MS-3420-10	14.27	15.62	21.94	60.32	1/16	1/16
MS-3420-12	15.87	18.80	26.90	57.15	1/16	1/16
MS-3420-16	19.05	23.5	26.39	53.97	1/16	1/16
MS-3420-20	23.80	31.50	40.41	50.80	1/16	1/16
MS-3420-2	31.75	3.67	46.79	4	7.62 1 16	1/16

## Other accessories

### Protective cap for MS and 97 series

#### MS-25042

For Pugs as external threads and is used on all plugs where a coupling ring is provided.

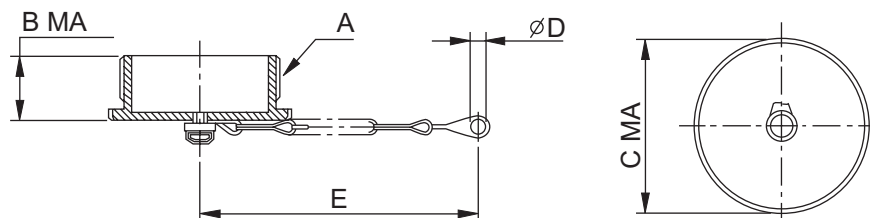

All dimensions are in mm

MS art number	For connector size	A Thread in inches	B	C	D	E
MS 25042-10-1	MS 10S-1-SL	5/8-2	16.67	17.4	4	102
MS 25042-12-1	MS 12-12S	3/4 - 20	21.4	20.6	4	115
MS 25042-14-1	MS 1 -14S	7/8-20	21.4	23.7	4	115
MS 25042-16-1	MS 16-16S	1-20	21.4	26.9	4	115
MS 25042-18-1	MS 18	1 1/8-18	21.4	30	4	115
MS 25042-20-1	MS 20	1 1/4 -18	21.4	33	.8	127
MS 25042-22-1	MS 22	1 3/8-18	21.4	36.4	.8	127
MS 25042-24-1	MS 24	1 1/2-18	21.4	39.6	.8	10
MS 25042-28-1	MS 28	1 3/4 -18	21.4	6	4.8	197
MS 25042-32-1	MS 32	2-18	21.4	52	5.6	197
MS 25042-36-1	MS 36	2 1/4 -18	21.4	58.7	5.6	197
MS 25042- 0-1	MS 40	2 / 2-16	21.4	65	5.6	197

## Protective cap for MS and 97 series

### MS-25043

For receptacles Has internal threads and is used on all receptacles. Gasket is provided in the dust cap forming a water tight seal.

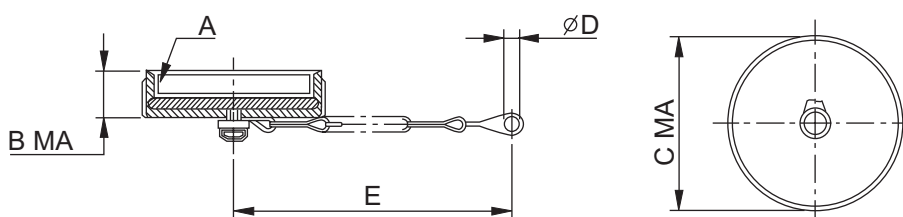

All dimensions are in mm

MS art number	For connector size	A Thread in inches	B	C	D	E
MS 25043-10-1	MS 10S-1-SL	5/8-2	11.11	20.7	3.6	102
MS 250 3 -12-1	MS 12-12S	3/4 - 20	11.11	25.4	3.6	115
MS 250 3 -1 -1	MS 1 -14S	7/8-20	11.11	28.6	3.6	115
MS 250 3 -16-1	MS 16-16S	1-20	11.11	30.2	3.6	115
MS 250 3 -18-1	MS 18	1 1/8-18	11.11	34.1	3.6	115
MS 250 3 -20-1	MS 20	1 1/4 -18	11.11	37.3	4.4	127
MS 250 3 -22-1	MS 22	1 3/8-18	11.11	40.4	4.4	127
MS 250 3 -2 -1	MS 24	1 1/2-18	11.11	43.6	4.4	140
MS 250 3 -28-1	MS 28	1 3/4 -18	12.7	50	4.4	197
MS 250 3 -32-1	MS 32	2-18	12.7	56.3	4.8	197
MS 250 3 -36-1	MS 36	2 1/4 -18	12.7	62.7	4.8	197
MS 250 3 - 0-1	MS 4 0	2 1/2-16	12.7	69	4.8	197

#### Notes

1. For protective caps without chain or with nylon cord, contact factory.
2. Standard - black anodised finish. For alternative finishes, contact factory.
3. Standard - straight knurling. For diamond knurling on caps, contact factory.

**Other accessories**

**Protective cap for 97B series**

**97B-25042**

For plugs Has external grooves and is used on all plugs

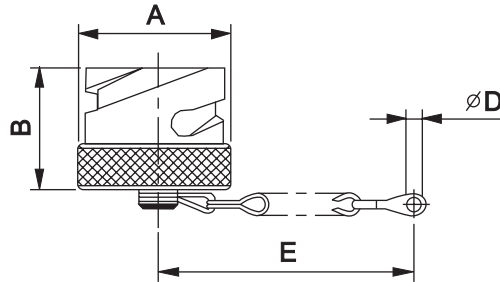

All dimensions are in mm

art number	For connector size	A max	B	D	E
97B 250 2-10SL	10SL	23.00	2.00	.20	102
97B 250 2-1 S	1 S	30.00	2.00	.20	115
97B 250 2-16S	16S	32.50	2.00	.20	115
97B 250 2-16	16	32.50	33.00	.70	115
97B 250 2-18	18	36.0	39.00	.70	115
97B 250 2-20	20	0.50	33.00	.70	127
97B 250 2-22	22	3.50	33.00	.70	127
97B 250 2-2	2	6.50	.00	.70	10
97B 250 2-28	28	5.00	33.00	5.60	197
97B 250 2-32	32	60.00	6.00	5.60	197
97B 250 2-36	36	66.20	6.00	5.60	197
97B 250 2-0	0	73.00	33.00	5.60	197

**Protective cap for 97 Bseries**

**97B-25043**

For plugs Has internal bayonet pins and is used on all receptacles.

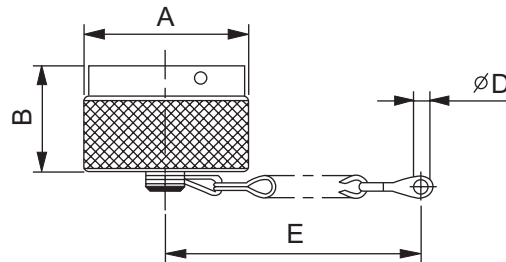

All dimensions are in mm

art number	For connector size	A max	B	D	E
97B 250 3-10SL	10SL	23.00	15.50	.20	102
97B 250 3-1 S	1 S	30.00	15.50	.20	115
97B 250 3-16S	16S	32.50	15.50	.20	115
97B 250 3-16	16	32.50	21.20	.20	115
97B 250 3-18	18	37.00	21.20	.20	115
97B 250 3-20	20	0.50	21.20	.70	127
97B 250 3-22	22	3.50	21.20	.70	127
97B 250 3-2	2	7.00	21.20	.70	10
97B 250 3-28	28	5.00	21.20	5.60	197
97B 250 3-32	32	60.50	21.20	5.60	197
97B 250 3-36	36	67.00	21.20	5.60	197
97B 250 3-0	0	73.00	21.20	5.60	197

- Notes
1. For protective caps without chain or with nylon cord, contact factory.
  2. Standard - black anodised finish. For alternative finishes, contact factory.
  3. Standard - straight knurling. For diamond knurling on caps, contact factory.



**Other accessories**  
**Plain Flat Gasket**  
 for MS, 97 and 97B flange mounted receptacles

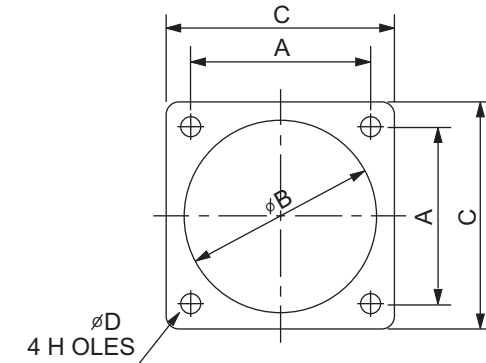

All dimensions are in mm

art number	For connector size	A max	B	C	D
MS-101000	10SL	18.26	15.90	25.40	4.35
MS-108686	12S & 12	20.62	19.05	27.80	4.35
MS-101001	14S&14	23.01	22.20	30.15	4.35
MS-101002	16S & 16	24.61	25.40	32.50	4.35
MS-101003	18	27.00	28.57	34.90	5.15
MS-101004	20	29.36	31.75	38.10	5.15
MS-101005	22	31.75	34.90	41.20	5.15
MS-108687	24	34.90	38.10	44.45	5.15
MS-101006	28	39.70	44.45	50.80	5.15
MS-108688	32	44.45	50.80	57.15	5.55
MS-101007	36	49.22	55.57	63.50	5.55
MS-110831	40	55.77	61.92	69.85	5.55

**P Adaptor**

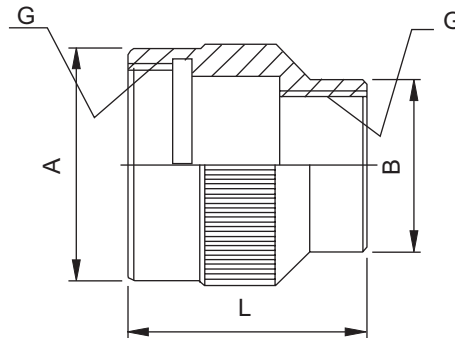

Shell size	G Thread in inches	G 9			G 11			G 13			G 16			G 21			G 29			G 36			
		A	B	L	A	B	L	A	B	L	A	B	L	A	B	L	A	B	L	A	B	L	
10SL	5 8-2																						
12S	11 16-2																						
1	3 -20				23	23	30	23	23	30													
16	7 8-20				25	25	30				25	25	30										
18	1-20	30	21	26	30	26	37				30	28	37										
20	1 1 8-18				35	26	0				35	28	0	35	35	0							
22	1 1 -18										35	28	0	35	35	0							
2	1 3 8-18													38	35	0	0	0	0				
28	1 5 8-18													5	37	5	5	5	5				
36	2 1 8-18																	57		55	57	57	55

Note - For ordering information on flat gaskets and G adaptors, contact factory.

**Other accessories**  
**Dummy receptacle**  
**MS-3105**

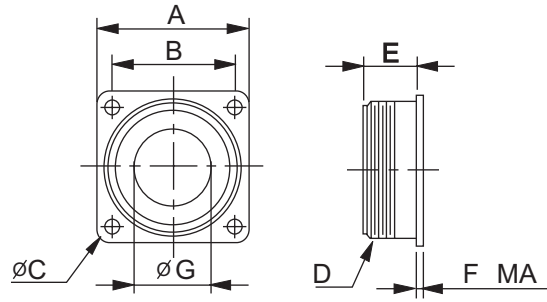

All dimensions are in mm

Part number (see note)	A	B	C	D Thread in inches	E	F max.	G
MS-3105-10S	25.4	18.26	3.05	5/8-24	14.27	3.96	8.20
MS-3105-12S	27.79	20.62	3.05	3/4-20	14.27	3.96	11.43
MS-3105-12	27.79	20.62	3.05	3/4-20	19.05	3.96	11.43
MS-3105-14S	30.17	23.01	3.05	7/8-20	14.27	3.96	13.36
MS-3105-14	30.17	23.01	3.05	7/8-20	19.05	3.96	13.36
MS-3105-16S	32.54	24.61	3.05	1-20	14.27	3.96	16.41
MS-3105-16	32.54	24.61	3.05	1-20	19.05	3.96	16.41
MS-3105-18	34.92	26.97	3.05	1 1/8 - 18	19.05	5.16	18.03
MS-3105-20	38.10	29.36	3.05	1 1/2 - 18	19.05	5.16	23.54
MS-3105-22	41.27	31.75	3.05	1 3/4 - 18	19.05	5.16	25.93
MS-3105-24	44.45	34.92	3.73	2 - 18	20.62	5.16	29.21
MS-3105-28	50.8	39.67	3.73	2 1/4 - 16	20.62	5.16	34.67
MS-3105-36	63.5	49.22	4.39	3 - 16	22.2	9.11	46.56

Note The dash number also indicates shell size.

**Special accessories**

For special accessories, please contact factory with specifications and drawings. Amphenol has in-house capability to meet and custom build your special accessories requirements for its range of MIL-C5015 MS, 97 and 97B series connectors.

## Ordering MS/97 series connectors

To obtain the specific connector required, write down the connector number from the typical example below. Only inserts shown in the availability chart shown on page 7 can be specified. Connectors are delivered with protective plastic dust covers. Include premating contact designation only if premating contact is required. The second letter in the premating contact designation stands for the actual contact position. Any deviation from the specified design is indicated by - at the end of the connector number. - at the end of the connector number indicates telescopic bushing provided.

