



## CRYSTAL OSCILLATOR PROGRAMMABLE

**NEW**



Product Number (please contact us)  
X1G003xx2xxxx00

## SG - 8003 series

- Frequency range : 1 MHz to 166 MHz
- Supply voltage : 1.8 V / 2.5 V / 3.0 V / 3.3 V
- Function : Output enable(OE) or Standby( $\overline{ST}$ )

- Short mass production lead time by PLL technology.
  - SG-Writer available to purchase.
- Please contact Epson Toyocom or local sales representative.

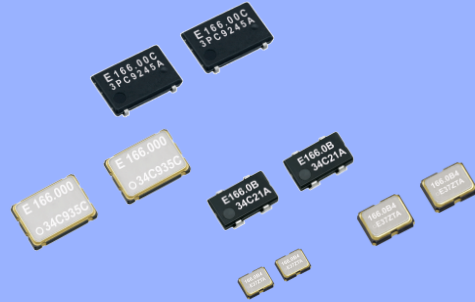

### Specifications (characteristics)

Item	Symbol	Specifications			Conditions / Remarks
		PE / SE	PD / SD	PC / SC	
Output frequency range	$f_0$	1 MHz to 166 MHz			
Supply voltage	$V_{CC}$	1.8 V Typ. 1.6 V to 2.2 V	2.5 V Typ. 2.2 V to 2.8 V	3.3 V Typ. 2.7 V to 3.6 V	
Storage temperature	$T_{stg}$	-40 °C to +85 °C			Storage as single product.
Operating temperature	$T_{use}$	-20 °C to +70 °C / -40 °C to +85 °C			
Frequency tolerance	$f_{tol}$	B: $\pm 50 \times 10^{-6}$ , C: $\pm 100 \times 10^{-6}$			-20 °C to +70 °C
		L: $\pm 50 \times 10^{-6}$ , M: $\pm 100 \times 10^{-6}$			-40 °C to +85 °C
Current consumption	$I_{CC}$	3.5 mA Max.	4.0 mA Max.		No load condition, 1 MHz $\leq f_0 \leq 25$ MHz
		5.0 mA Max.	6.5 mA Max.		No load condition, 25 MHz $< f_0 \leq 50$ MHz
		6.0 mA Max.	8.5 mA Max.		No load condition, 50 MHz $< f_0 \leq 75$ MHz
		7.0 mA Max.	10.5 mA Max.		No load condition, 75 MHz $< f_0 \leq 100$ MHz
		8.5 mA Max.	12.5 mA Max.		No load condition, 100 MHz $< f_0 \leq 125$ MHz
		10.0 mA Max.	15.0 mA Max.		No load condition, 125 MHz $< f_0 \leq 166$ MHz
Output disable current	$I_{dis}$	8 mA Max.			OE=GND (PE,PD,PC)
Stand-by current	$I_{std}$	50 $\mu$ A Max.			$\overline{ST}$ =GND (SE,SD,SC)
Symmetry	SYM	45 % to 55 %			50 % $V_{CC}$ level, $L_{CMOS} \leq 15$ pF
Output voltage	$V_{OH}$	90 % $V_{CC}$ Min.		$V_{CC} - 0.4$ V Min.	$I_{OH} = -4$ mA (PD,SD,PE,SE), $-8.0$ mA (PC,SC)
	$V_{OL}$	10 % $V_{CC}$ Max.		0.4 V Max.	$I_{OL} = 4$ mA (PD,SD,PE,SE), $8.0$ mA (PC,SC)
Output load condition (CMOS)	$L_{CMOS}$	15 pF Max.			
Input voltage	$V_{IH}$	80 % $V_{CC}$ Min.			OE terminal or $\overline{ST}$ terminal
	$V_{IL}$	20 % $V_{CC}$ Max.			
Rise and Fall time	$t_r / t_f$	5.0 ns Max.			1 MHz $\leq f_0 < 80$ MHz   20 % $V_{CC}$ to 80 % $V_{CC}$
		2.5 ns Max.			80 MHz $\leq f_0 \leq 166$ MHz   level, $L_{CMOS} = 15$ pF
Start-up time	$t_{str}$	5 ms Max.			$t=0$ at 90 % $V_{CC}$
Frequency aging	$f_{aging}$	$\pm 3 \times 10^{-6}$ / year Max.			+25 °C, First year, $V_{CC} = 1.8$ V, 2.5 V, 3.3 V

### Current consumption

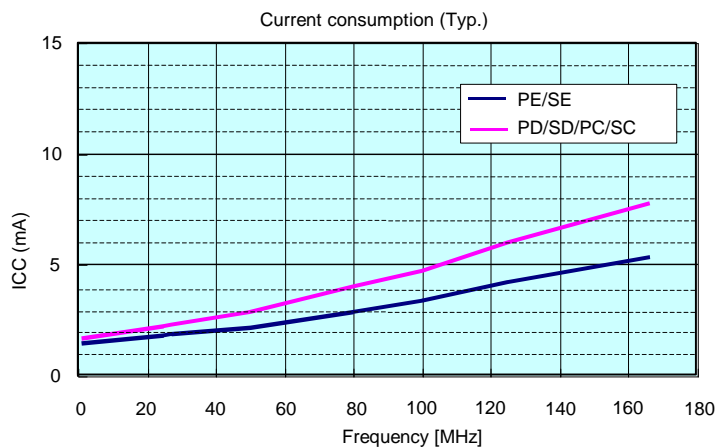

External dimensions

(Unit:mm)

SG-8003CG

NEW

Actual size

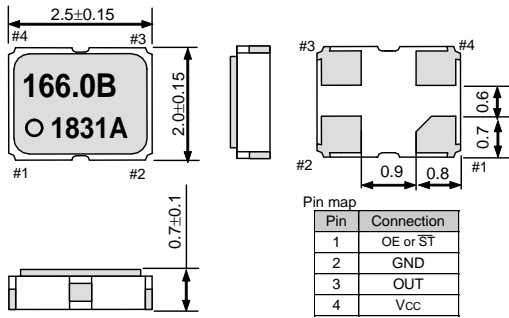

Footprint (Recommended)

(Unit:mm)

SG-8003CG

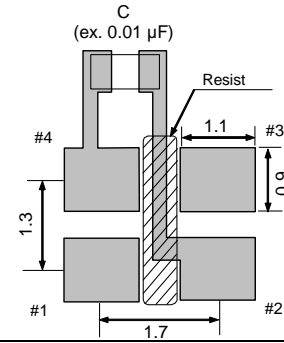

SG-8003CE

Actual size

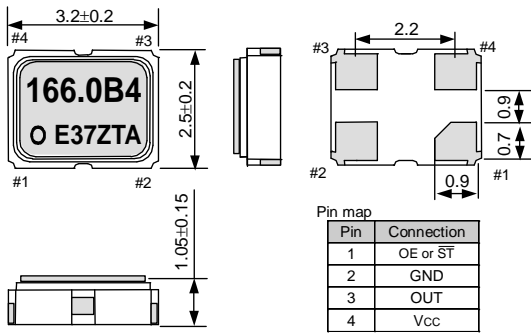

SG-8003CE

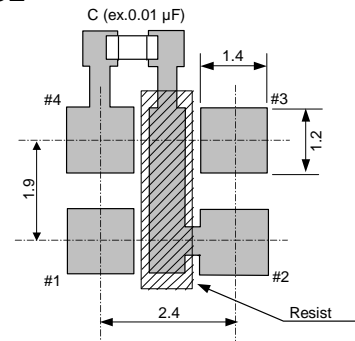

SG-8003LB

Actual size

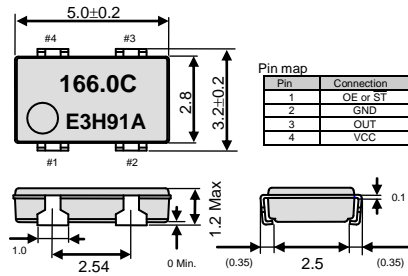
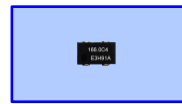

Metal may be exposed on the top or bottom of this product. This will not affect any quality, reliability or electrical spec.

SG-8003LB

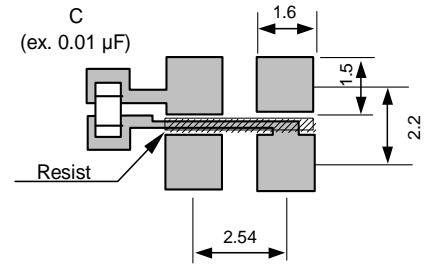

SG-8003CA

Actual size

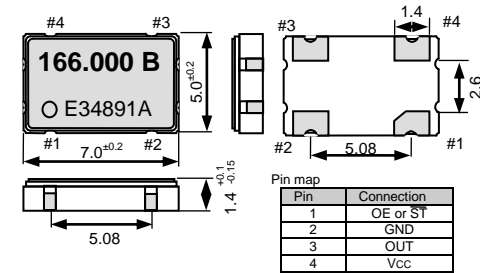

SG-8003CA

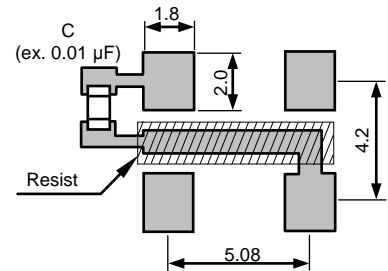

SG-8003JF

Actual size

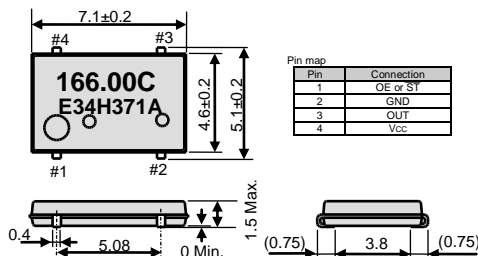

SG-8003JF

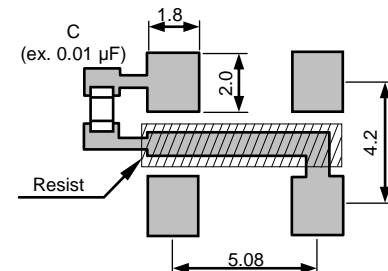

Note.

OE Pin (PE, PD, PC)  
 OE Pin = "H" or "open" : Specified frequency output.  
 OE Pin = "L" : Output is low level (weak pull - down)

ST Pin (SE, SD, SC)  
 ST Pin = "H" or "open" : Specified frequency output.  
 ST Pin = "L" : Output is low level (weak pull - down), oscillation stops.

To maintain stable operation, provide a 0.01µF to 0.1µF by-pass capacitor at a location as near as possible to the power source terminal of the crystal product (between Vcc - GND).