

Features

ICE Technology*

- Up to 81°C ambient, no derating
- 120°C Maximum Case Temperature
- -45°C Minimum Temp. (optional: -55°C)
- Built-in FCC/EN55022 Class B Filter
- 2:1 Wide Input Voltage Range
- 50 Watts Output Power
- Ribbed, Flat or Baseplate Case Styles
- Efficiency to >91%
- 3kVDC Isolation
- Fully Protected
- Low Quiescent Current

Description

The RPP50 series 2:1 input range DC/DC converters are ideal for high end industrial applications and COTS Military applications where a very wide operating temperature range of -45°C to +120°C is required. The converters are also optionally available with a -55°C start-up temperature. Although the case size is very compact, the converter contains a built-in filter EN55022 Class B / FCC Level B without the need for any external components. The RPP50 is available in three case styles: the high operating temperature ribbed case, the low profile flat case and the baseplate case for high vibration or bulkhead-mounting applications. They are UL-60950-1 certified.

Selection Guide 24V and 48V Input Types

Part Number	Input Range VDC	Output Voltage VDC	Output Current A	Input ⁽¹⁾ Current mA	Efficiency ⁽²⁾ (Typ.)	Max ⁽³⁾ Operating Temp
RPP50-243.3S	18-36	3.3	15	58/2405	86.6%	58°C
RPP50-2405S	18-36	5	10	60/2315	90.0%	74°C
RPP50-2412S	18-36	12	4.16	18/2370	88.3%	66°C
RPP50-2415S	18-36	15	3.33	18/2315	90.0%	74°C
RPP50-2424S	18-36	24	2.10	18/2315	90.0%	74°C
RPP50-483.3S	36-75	3.3	15	42/1177	88.6%	68°C
RPP50-4805S	36-75	5	10	37/1140	91.4%	81°C
RPP50-4812S	36-75	12	4.16	11/1165	89.4%	72°C
RPP50-4815S	36-75	15	3.33	11/1141	91.2%	81°C
RPP50-4824S	36-75	24	2.10	11/1141	91.2%	81°C

** add suffixes for case, temperature or CTRL logic options.

Derating Graph (Ambient Temperature)

RPP50-4805S

Derating graphs are valid only for the shown part numbers. Please contact Technical Support for more information info@recom-development.at

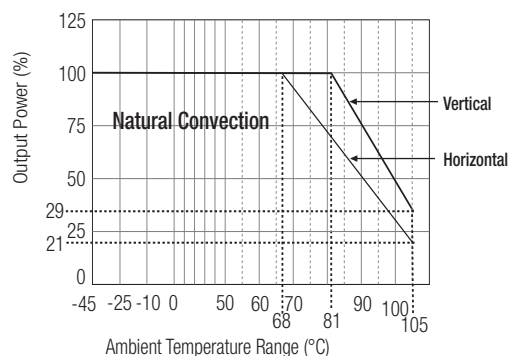

POWERLINE+

DC/DC-Converter

with 3 year Warranty

RECOM

50 Watt 2:1 Single Output

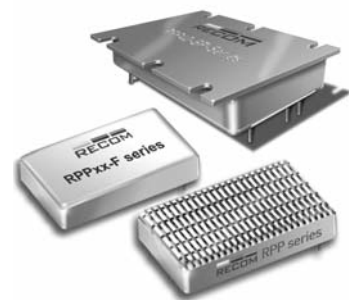

**UL-60950-1 Certified
E224736**

RPP50-S

SUFFIX INFORMATION

none = Standard Ribbed Case
 -B = Baseplate Case
 -F = Flat Case
 -L = Low Temp (-55°C) Ribbed Case
 -M = Low Temp (-55°C) Baseplate Case
 -T = Low Temp (-55°C) Flat Case

add "1" before suffix for neg. CTRL logic
 e.g. -1, -1B, -1F, etc.

* ICE Technology

ICE (Innovation in Converter Excellence) uses state-of-the-art techniques to minimise internal power dissipation and to increase the internal temperature limits to extend the ambient operating temperature range to the maximum. Refer to Application Notes

Specifications (typical at nominal input and 25°C unless otherwise noted)

Input Voltage Range	24V nominal input 48V nominal input	18-36VDC 36-75VDC
Under Voltage Lockout	24V input 48V input	DC-DC ON (min.) DC-DC OFF (max.) DC-DC ON (min.) DC-DC OFF (max.)
		17.5VDC 17VDC 35VDC 34VDC
Input Filter		Common Mode EMC Filter
Input Voltage Variation dv/dt (Complies with ETS300 132 part 4.4)		5V/ms max
Input Surge Voltage (100 ms max.)	24V Input 48V Input	50VDC 100VDC
Input Reflected Ripple	nominal Vin and full load	30mA _{p-p}
Start Up Time	nominal Vin and constant resistor load	2ms typ., 5ms max.
Remote ON/OFF ⁽⁴⁾	Logic High Logic Low	Open or 3.0V < Vr < 5.5V Short or 0V < Vr < 1.2V
Remote OFF input current	Nominal input	2mA typ.
Output Power		50W max.
Output Voltage Accuracy	10% Load and nominal Vin	±1%
Voltage Adjustability		±10%
Minimum Load		0%
Line Regulation	low line, high line at full load	±0.3%
Load Regulation	10% to 100% full load	±0.5%
Ripple and Noise (20MHz bandwidth limited) (measured with 1µF capacitor across output)	3.3V, 5V All others	60mV _{p-p} typ. 40mV _{p-p} typ.
Temperature Coefficient		±0.04%/°C max.
Transient Response	25% load step change	200µs
Over Load Protection	% of full load at nominal Vin	120% typ.
Short Circuit Protection		Hiccup, automatic recovery
Output Over Voltage Protection (refer to block diagram in Application Notes)		Converter shutdown if Vout > Vout nominal + 20%
Isolation Voltage		Rated at 2250VDC/1 minute, Flash tested at 3000VDC/1 second
Isolation Resistance		10MΩ min.
Isolation Capacitance (refer to block diagram in Application Notes)		3000pF max.
Operating Frequency		260kHz ± 40kHz Maximum
Case Temperature		+120°C
Storage Temperature Range		-55°C to +125°C
Over Temperature Protection (refer to block diagram in Application Notes)		internal thermistor
RPP50 Operating Temperature Range	Ambient, Free Convection -55°C Version	-45°C to +81°C max (without derating) -55°C to +81°C max (without derating)
Thermal Impedance (Natural convection)	Ribbed Case: Vertical Ribbed Case: Horizontal	7.3°C/Watt 10°C/Watt
Relative Humidity		5% to 95% RH
Case Material ⁽⁷⁾		Aluminium
Potting Material		Silicone (UL94-V0)
Weight	Ribbed Case Flat Case Baseplate Case	39g 34g 43g
Packing Quantity	Ribbed and Flat Case Baseplate Case	4 pcs per Tube Single Packed

Specifications (typical at nominal input and 25°C unless otherwise noted)

Safety Standards		certified UL-60950-1, 1st Edition
Thermal Cycling		complies with MIL-STD-810F
Vibration		10-55Hz, 12G, 30 Min. along X, Y and Z
Conducted Emissions	EN55022	Class B
Radiated Emissions	EN55022	Class B
ESD	EN61000-4-2	Perf. Criteria B
Radiated Immunity	EN61000-4-3	Perf. Criteria A
Fast Transient ⁽⁵⁾	EN61000-4-4	Perf. Criteria B
Surge ⁽⁶⁾	EN61000-4-5	Perf. Criteria B
Conducted Immunity	EN61000-4-6	Perf. Criteria A
MTBF calculated according to BELLCORE TR-NWT-000332 ⁽⁶⁾		1989 x 10 ³ hours

Notes :

1. Typical values at nominal input voltage and no load/full load.
2. Typical values at nominal input voltage and full load.
3. Typical values for ribbed case at nominal input voltage and full load in vertical orientation and with Eurocard-sized PCB ground planes to assist in heat dissipation. For horizontal orientation, reduce the maximum temperatures by 10°C.
4. The ON/OFF pin voltage is referenced to negative input. The pin is pulled high internally.
ON/OFF control is standard with positive logic: e.g. RPP50-4805S.
Add "1" before the suffix for negative logic: e.g. RPP50-2405S-1, RPP50-4805S-1B.
Positive logic: 0 = OFF, 1 = ON. The converter will be ON if the CTRL is left open.
Negative logic: 1 = OFF, 0 = ON. The converter will be OFF if the CTRL is left open.
5. Requires an external 100µF low ESR capacitor to meet EN61000-4-4 and EN61000-4-5
6. Case I: 50% Stress, Temperature at 50°C (Ground Benign).
7. To ensure a good all-round electrical contact, the baseplate is pressed firmly into place within the aluminium housing. The hydraulic press can leave tooling marks and deformations to both the housing and baseplate. The case is anodised aluminium, so there will be natural variations in the case colour and the aluminium is not scratch resistant. Any resultant marks, scratches and colour variations are cosmetic only and do not affect the operation or performance of the converters.

External Output Trimming
Refer to Application Notes for
suggested Resistor Values

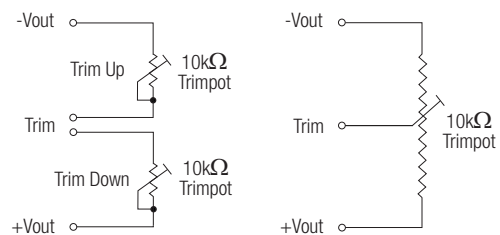

Typical Characteristics

RPP50-4805S

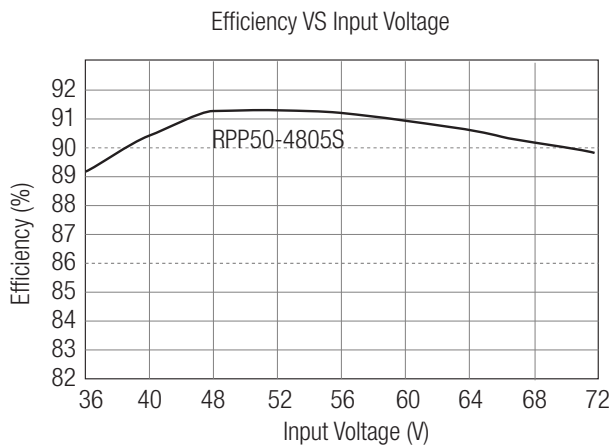

Recommended PCB Layout

Single Output

Dual Output

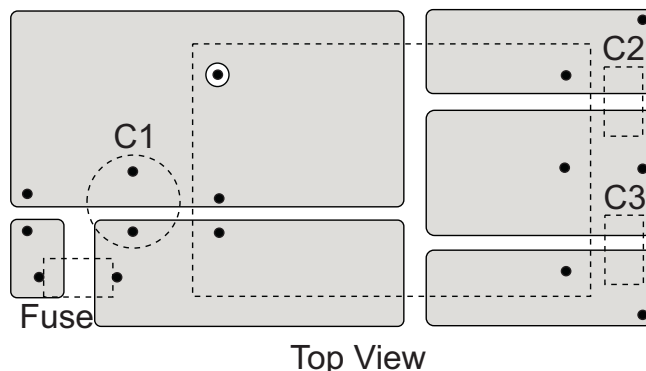
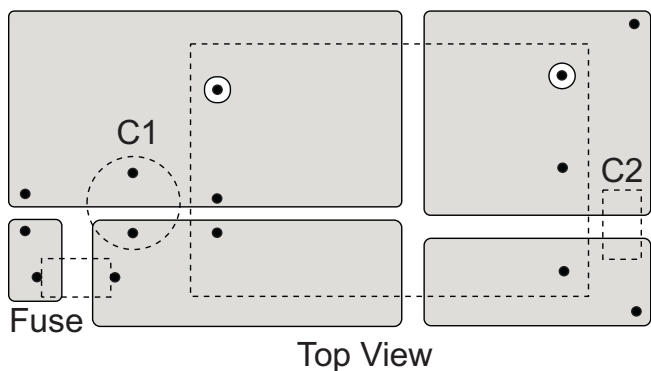

Baseplate Case- suggested PCB layout

Single Output

Dual Output

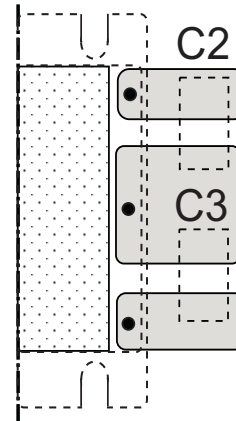
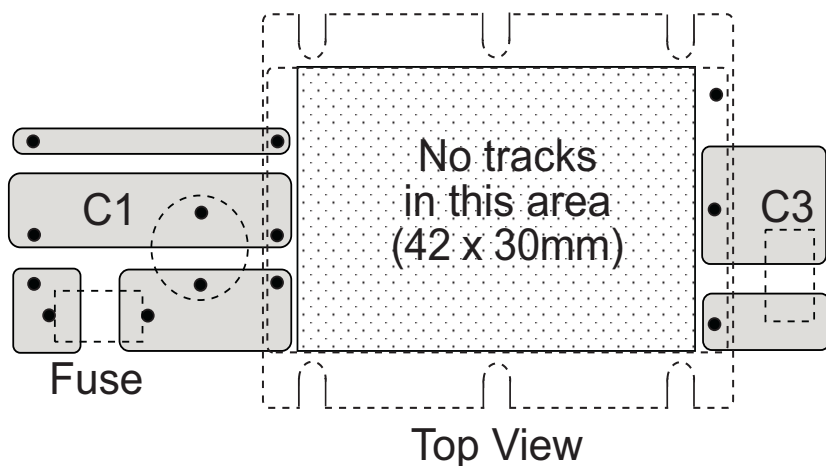

Input Fuse is recommended, but optional. Recommended fuse rating = double maximum input current, time delay type.

Input Capacitor, C1, is required to meet EN61000 Surge and Fast Transient, otherwise it is not required for normal operation.

Output Capacitors C2/C3 are recommended, but not required for normal operation. Typical capacitor values are 1µF MLCC

To ensure optimum thermal performance, use large areas of copper on the PCB to assist with heat dissipation and mount the converter vertically.

Package Style and Pinning (mm)

Ribbed Case (Standard - no Suffix)
(Low temperature version = suffix -L)

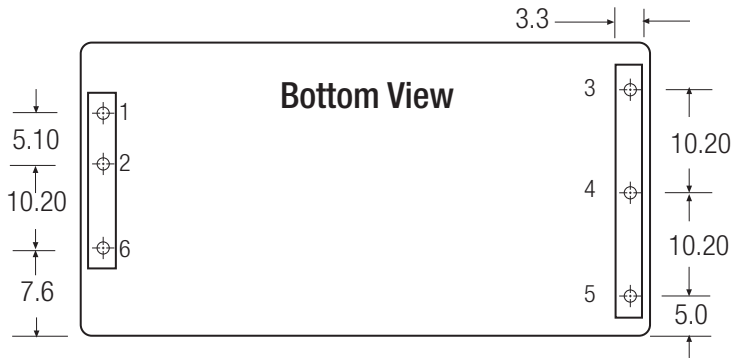
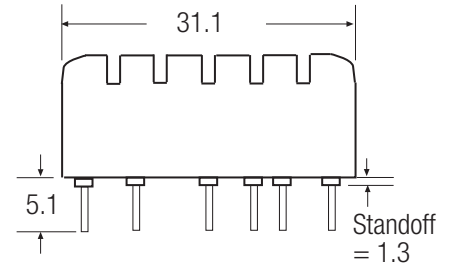
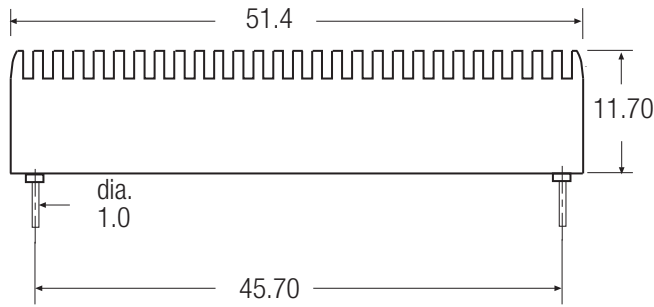

Pin Connections

Pin #	Single	Dual
1	+Vin	+Vin
2	-Vin	-Vin
3	+Vout	+Vout
4	-Vout	Com
5	Trim	-Vout
6	CTRL	CTRL

Pin Pitch Tolerance ± 0.35 mm

Flat Case (-F Suffix)
(Low temperature version = suffix -T)

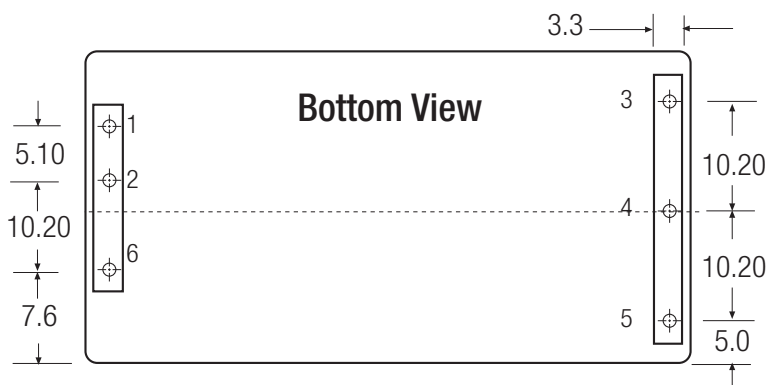
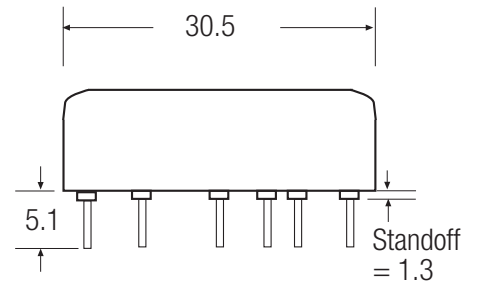
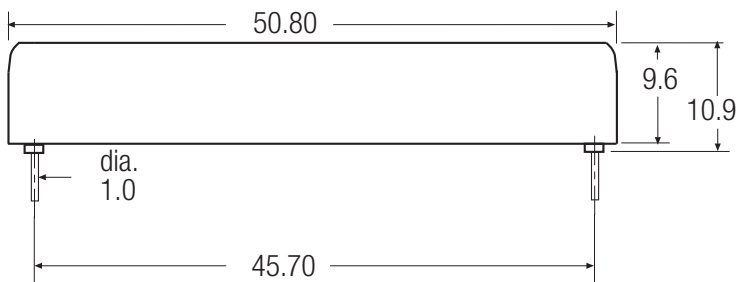

Pin Connections

Pin #	Single	Dual
1	+Vin	+Vin
2	-Vin	-Vin
3	+Vout	+Vout
4	-Vout	Com
5	Trim	-Vout
6	CTRL	CTRL

Pin Pitch Tolerance ± 0.35 mm

Typical Characteristics

Baseplate Case (-B Suffix)
(Low temperature version = suffix -M)

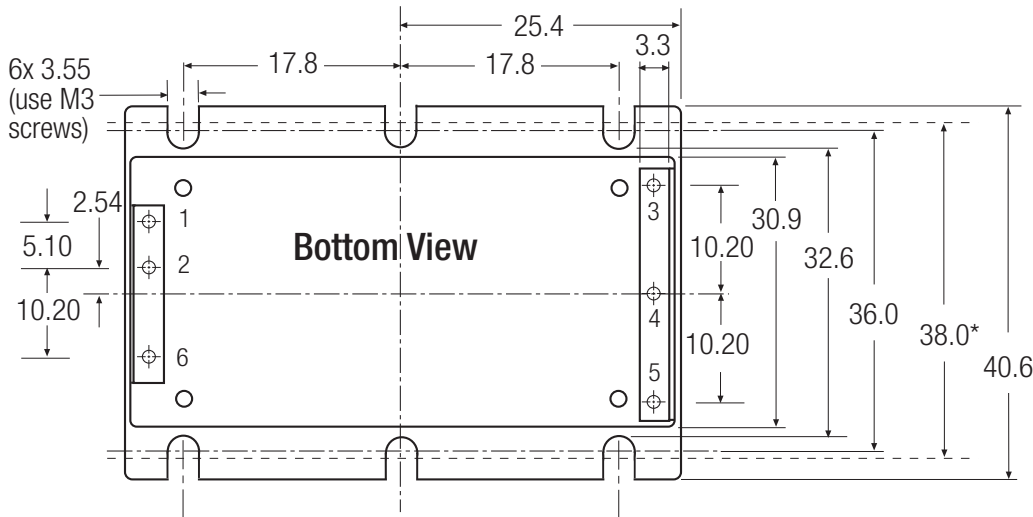
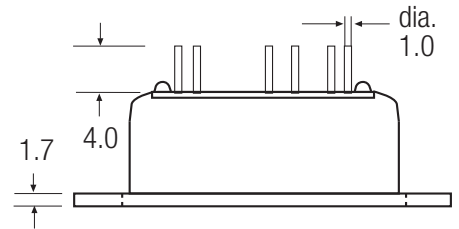
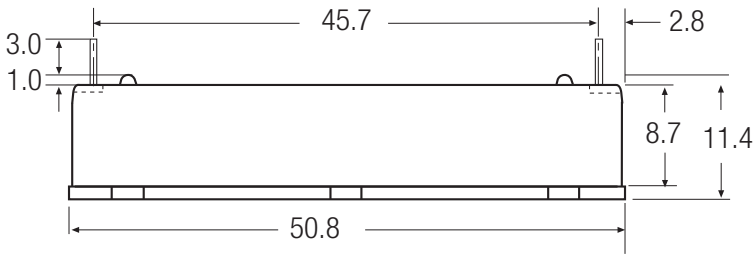

Pin Connections

Pin #	Single	Dual
1	+Vin	+Vin
2	-Vin	-Vin
3	+Vout	+Vout
4	-Vout	Com
5	Trim	-Vout
6	CTRL	CTRL

Pin Pitch Tolerance ± 0.35 mm

*Recommended Fixing Centres

RPP50

Baseplate Case Fixing - Mounting onto Heatsink/Bulkhead

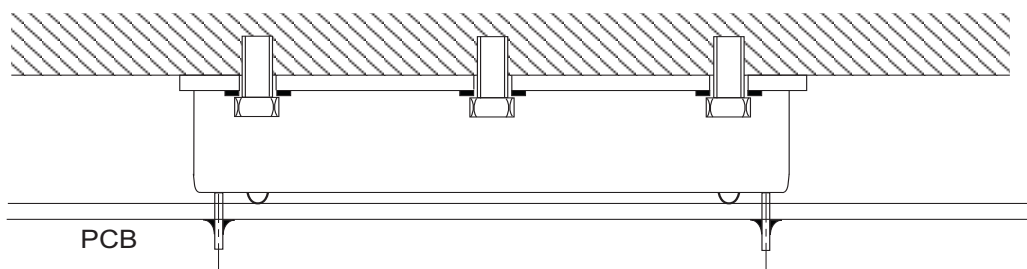

Baseplate Case Fixing - Anti Vibration Mounting onto PCB

